

rendi  
light  
studio

CATALOGO LUCI

**2024**





## INDICE

|                                 |         |
|---------------------------------|---------|
| SPIEGAZIONI                     | 4-5     |
| LAMPADE A SOSPENSIONE           | 6-87    |
| LAMPADE DA SOFFITTO             | 88-175  |
| LAMPADE DA PARETE               | 176-265 |
| FARETTI                         | 266-317 |
| LAMPADE DA TAVOLO               | 318-347 |
| LAMPADE DA TERRA                | 348-371 |
| LAMPADE DA INCASSO              | 372-481 |
| SISTEMI 3F                      | 482-531 |
| SISTEMI 1F                      | 532-555 |
| STRISCE LED                     | 556-565 |
| PARALUMI ED ACCESSORI           | 566-619 |
| LUCI DA ESTERNO                 | 620-725 |
| SORGENTI LUMINOSE               | 726-743 |
| ACCESSORI PER LAMPADE           | 744-751 |
| INDICE ALFABETICO DELLE LAMPADE | 752-755 |
| INDICE ID                       | 756-759 |

# SPIEGAZIONI



## NOME

Descrizione del prodotto

### Prodotto

230 V/350 mA LED... dati tecnici

Numero di catalogo (ID) colore / materiale

PREZZO ➔

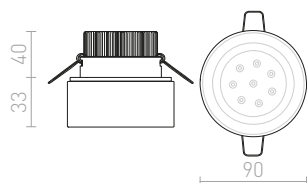

- È incluso nella confezione
- NON è incluso nella confezione
- ↑ profondità di incasso in mm
- foro da incasso rotondo in mm
- ▣ foro da incasso quadrato in mm
- ∩<sup>20°</sup> angolo di inclinazione
- ∩<sup>90°</sup> angolo di rotazione
- 44 dimensioni (in mm)
- NEW novità
- % merce a prezzo scontato
- ➔ vendita da liquidazione del magazzino

I valori di flusso luminoso indicati sono i valori nominali del flusso luminoso generato dalla sorgente luminosa. Il flusso luminoso generato dall'apparecchio si differenzia in base alle perdite sulla parte ottica dell'apparecchio.

I valori di consumo energetico indicati sono i valori nominali del consumo della sorgente luminosa. Il consumo energetico dell'apparecchio sarà superiore alle perdite dell'attuatore.

I produttori si riservano il diritto di modificare i parametri di ciascun prodotto durante la validità del catalogo.

% e ➔ - prodotti contrassegnati sono in quantità limitata e la loro disponibilità non è garantita per tutta la validità del catalogo.

## GARANZIA ESTESA

La garanzia standard fornita a tutti i clienti è di DUE ANNI.

Per un progetto individuale più grande è possibile negoziare una GARANZIA CONTRATTUALE ESTESA, determinata in base al tipo di merce, al volume e alla durata della garanzia.

## ESCLUSIONE DI RESPONSABILITÀ

Soggetto a modifiche senza preavviso. Errori ed omissioni riservati. Assicurarsi sempre di utilizzare la versione più recente. In caso di utilizzo di sorgenti e accessori diversi da quelli consigliati, non possiamo garantire il corretto funzionamento degli apparecchi.

## GRADO DI PROTEZIONE IP

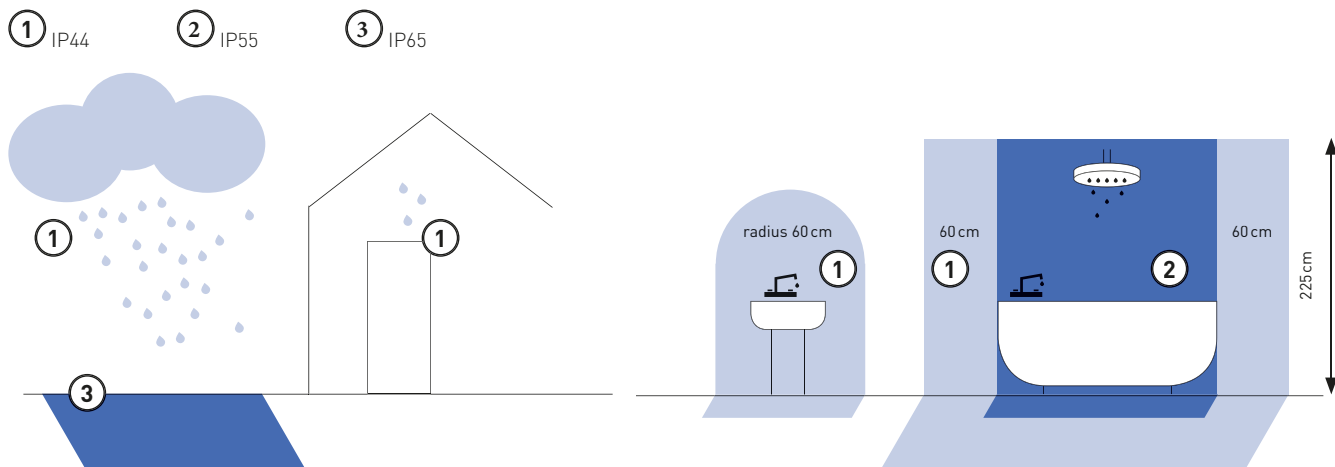

## INSTALLAZIONE DI APPARECCHI DA INCASSO PER ESTERNI

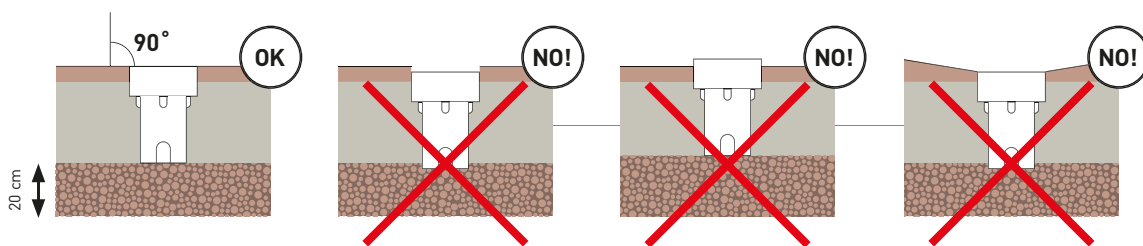

**LED** Integrato



Interruttore a levetta

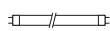

**T5** Lampada fluorescente



Interruttore con pulsante dimmer

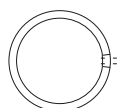

**2GX13** Lampada fluorescente



Interruttore di alimentazione



Sorgente luminosa raccomandata, maggiori informazioni nella categoria Sorgenti luminose.



Interruttore a pulsante

G11841



Trasformatore non dimmerabile



Interruttore a tirante



Apparecchio con driver TRIAC dimmerabile



Interruttore a bilanciere

dimmerabilità opzionale

Lampada può essere fornita con driver dimmerabile con costo aggiuntivo.



Interruttore a sfioramento



Interruttore rotativo



Trasformatore raccomandato, ulteriori informazioni nella categoria Accessori.



Sensore PIR, sensore di movimento a infrarossi.



Sensore MW, sensore di movimento a microonde.



DIMM TO WARM, regolazione della temperatura del colore della luce.



## LAMPADE A SOSPENSIONE

|                          |       |
|--------------------------|-------|
| DECORATIVE               | 14-31 |
| MULTIPLE                 | 32-33 |
| IN VETRO                 | 34-51 |
| POSIZIONABILI            | 52-57 |
| IN METALLO               | 58-73 |
| CIRCOLARI DESIGN TECNICO | 74-77 |
| QUADRATE DESIGN TECNICO  | 78-81 |
| LONGITUDINALI            | 82-85 |
| INDUSTRIALI              | 86-87 |

# A SOSPENSIONE DECORATIVE



**FLORIDA**  
14-15



**HEIDI**  
14-15



**RADICAL**  
14-15

14-31



**ELLA**  
14-15



**CAMINO**  
16-17



**BURTON**  
16-17



**ILUSIA**  
16-17



**JACK RC**  
16-17



**ESME 76**  
18-19



**NANCY III**  
18-19



**TUTTI**  
18-19



**FRUTTI**  
18-19



**ENCOMBRE**  
20-21



**CONFETTI**  
20-21



**COCO**  
20-21



**ZALA**  
22-23



**RARA**  
22-23



**EZRA 40**  
22-23



**CLANK**  
22-23



**BUCKY 40**  
24-25



**VESCO**  
24-25



**JAMAICA 34**  
24-25



**POLLOCK**  
24-25



**ESPLANADE**  
26-27



**ICAR**  
26-27



**CHOUPEPTE**  
26-27



**AMICI**  
26-27



**FIATLUX 41/24**  
28-29



**FANCY 35/25**  
28-29



**FANCY 50/30**  
28-29



**GLAMOUR 35/20**  
28-29



**LALO 55**  
30-31



**LALO 40**  
30-31



**LOPE 80**  
30-31



**AINO 40**  
30-31

## A SOSPENSIONE MULTIPLE



**ASTRAL**  
32-33



**ASTROMET VII**  
32-33



**CINDY VI**  
32-33

32-33

## A SOSPENSIONE IN VETRO



**BEAU MONDE 25**  
34-35



**BEAU MONDE 30**  
34-35



**BEAU MONDE 35**  
34-35

34-51



**LUNA 20**  
36-37



**LUNA 25**  
36-37



**LUNA 30**  
36-37



**BOLLY 17**  
36-37



**LUNEA 30**  
38-39



**LUNEA 40**  
38-39



**LUNEA 50**  
38-39



**JULIETTA 16**  
40-41



**JULIETTA 31**  
40-41



**BABU NEW 22**  
40-41



**BELLINI L E14**  
42-43



**BELLINI M LED**  
42-43



**AZRIA**  
42-43



**CORONA**  
42-43



**PULIRE CON**  
44-45



**PULIRE RD**  
44-45



**COROA NEW 28**  
44-45



**SANSSOUCI I**  
46-47



**SANSSOUCI I**  
46-47



**GARNISH**  
46-47



**EIGHT**  
46-47



**TOMBA**  
46-47



**ESTRA V**  
48-49



**ESTRA I**  
48-49



**GIFT I**  
48-49



**DADOS NEW**  
50-51



**LIZ NEW**  
50-51



**DADOS III 60**  
50-51



**DADOS III 80**  
50-51



**LIZ III 60**  
50-51



**LIZ III 80**  
50-51

## A SOSPENSIONE POSIZIONABILI



**BROADWAY**  
52-53



**LEVITA**  
52-53



**BROADWAY**  
54-55





**MADISON C**  
54-55



**LOYD LED I**  
56-57



**LOYD E27 I**  
56-57



**LOYD E27 III**  
56-57

## A SOSPENSIONE IN METALLO

58-73



**GIULIA 12**  
58-59



**GIULIA 20**  
58-59



**GIULIA 40**  
58-59



**MAVRO**  
60-61



**RIGA 28**  
60-61



**STIG**  
60-61



**BOGARD**  
62-63



**BELENOS**  
62-63



**OPTIMUS**  
62-63



**AGNETA**  
64-65



**COPA**  
64-65



**DESTY I**  
64-65



**ARAQ**  
64-65



**ASTON 28**  
66-67



**ASTON 30**  
66-67



**BLONDIE 25**  
66-67



**MARGO**  
66-67



**MONROE 30**  
68-69



**MONROE 40**  
68-69



**SINTR A 40**  
68-69



**SINTR A 30**  
68-69



**BABADES I**  
70-71



**BABADES IV**  
70-71



**CARISSIMA 25**  
70-71



**CARISSIMA 40**  
70-71



**GOLDIE 36**  
72-73



**GOLDIE 46**  
72-73



**MERYLYN 48**  
72-73

## A SOSPENSIONE CIRCOLARI DESIGN TECNICO



**MEZZO 40**  
74-75



**MEZZO 60**  
74-75



**MEZZO 40/60**  
74-75

74-77



**MEZZO 80**  
74-75



**MEZZO 80**  
74-75



**MONETA**  
76-77



**LARISA R 30**  
76-77



**CASSABLANCA 40**  
76-77



**ASTERI**  
76-77

## A SOSPENSIONE QUADRATE DESIGN TECNICO



**MENSA SQ 48**  
78-79



**MENSA RC**  
78-79



**LARISA SQ 30**  
78-79

78-81



**STRUCTURAL LED 20x20**  
80-81



**STRUCTURAL LED 40x40**  
80-81



**STRUCTURAL LED 55x55**  
80-81

## A SOSPENSIONE LONGITUDINALI



**PESANTE 35**  
82-83



**PESANTE 75**  
82-83



**TRIDENT PRO 120**  
84-85

82-85



**TRIDENT PRO 150**  
84-85



**TRIDENT PRO**  
84-85

## A SOSPENSIONE INDUSTRIALI



**MEGALOS PRO 26**  
86-87



**MEGALOS PRO 30**  
86-87



**MEGALOS PRO 35**  
86-87

86-87



## ELLA

Lampada a sospensione in gesso per sorgente luminosa LED con portalampada E27. Base al soffitto in metallo laccato bianco. La superficie può essere colorata con vernici per interni.

### ELLA A SOSPENSIONE

230 V LED E27 15 W

R13788 gesso

€ 120

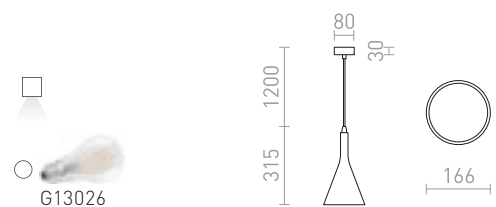



## FLORIDA

Lampada a sospensione in ceramica strutturata per sorgenti luminose E27.

### FLORIDA A SOSPENSIONE

230 V E27 28 W

R13298 ceramica

€ 98

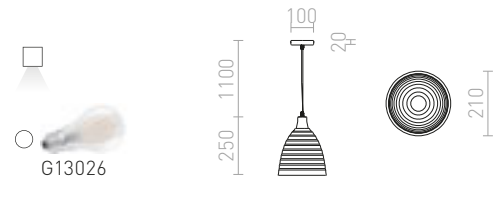

## RADICAL

Lampada a sospensione in calcestruzzo robusta, con corda di sospensione indipendente da cavo elettrico, per sorgenti luminose con portolampada E27.

### RADICAL A SOSPENSIONE

230 V E27 28 W

R12416 calcestruzzo

€ 158

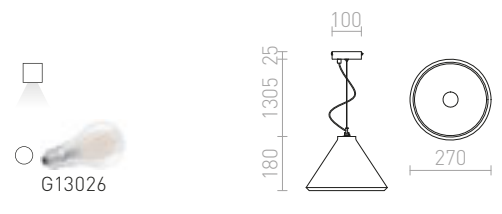

## HEIDI

Apparecchio a sospensione conico in calcestruzzo, con calotta in legno, adatto per sorgenti luminose E27.

### HEIDI A SOSPENSIONE

230 V E27 28 W

R12380 calcestruzzo/legno

€ 98

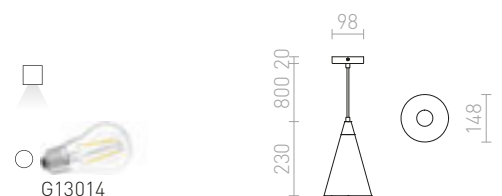



## ILUSIA

Lampada in filo di metallo a sospensione su cavo tessile per lampadina con attacco E27.

### ILUSIA A SOSPENSIONE

230 V E27 42 W

R13892 nero

€ 68 **NEW**

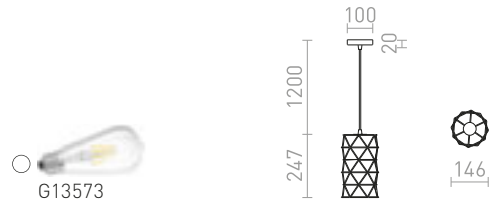

## BURTON

Lampada a sospensione in calcestruzzo con paralume di filo metallico per lampadine con portalampada E27.

### BURTON A SOSPENSIONE

230 V E27 42 W

R12931 calcestruzzo

€ 88



## JACK

Lampada a sospensione di gesso per sorgente luminosa con portalampada GU10. Base al soffitto in metallo laccato bianco. La superficie può essere colorata con vernici per interni.

### JACK RC A SOSPENSIONE

230 V GU10 35 W

R11676 gesso

€ 68 **%**

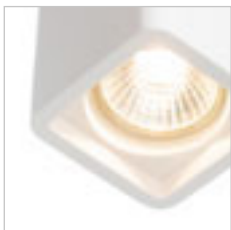
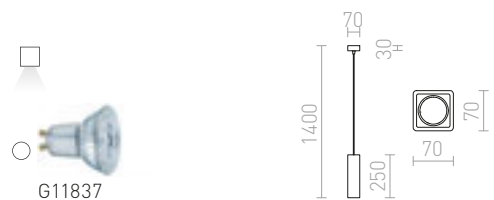



## CAMINO

Lampada a sospensione cilindrica per lampadina con portalampana E27. Il decoro di ogni apparecchio è originale.

### CAMINO A SOSPENSIONE

230 V E27 28 W

**R13296** terrazzo decor

€ 88

**R13297** cemento

€ 88

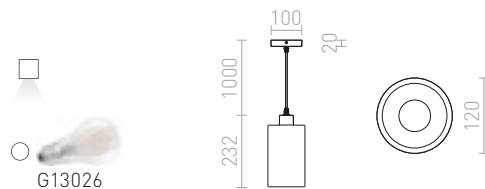





## TUTTI

Lampada a sospensione conica con illuminazione verso il basso. Adatto per sorgente luminosa con portalamпада E27.

### TUTTI A SOSPENSIONE

230 V E27 15 W

R13289 arancio/ceramica

€ 58 →

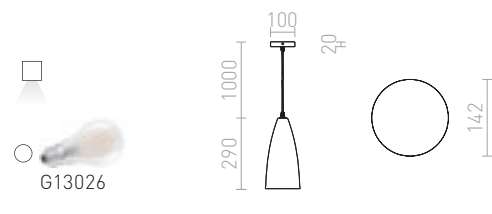

## FRUTTI

Lampada a sospensione per sorgente luminosa con portalamпада E27.

### FRUTTI A SOSPENSIONE

230 V E27 28 W

R13290 verde/ceramica

€ 48 →

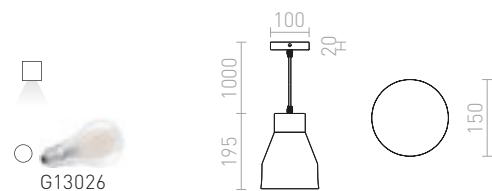





## NANCY

Lampada a sospensione con una base e tre paralumi in tessuto, per tre sorgenti luminose con portalampada E14.

### NANCY III A SOSPENSIONE

230 V E14 3x11 W

R13345 bianco/rosso

€ 48

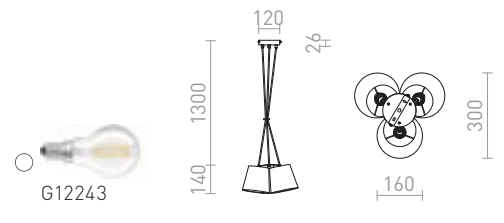

## ESME

Lampada a sospensione con paralume lungo, conico, bianco e fondo interno arancione.

### ESME 76 A SOSPENSIONE

230 V E27 28 W

R13276 bianco/arancio

€ 68

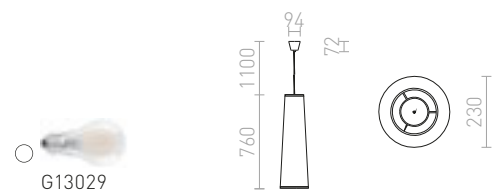



## ENCOMBRE

Lampada a sospensione decorativa composta da strati di foglie in plastica in tre varianti di colore. Fornita non assemblata, è necessario completarla.

### ENCOMBRE A SOSPENSIONE

230 V E27 42 W

**R12381** PVC bianco

€ 138

**R12382** pellicola cromata

€ 158

**R12383** lamina di rame

€ 178



G13026

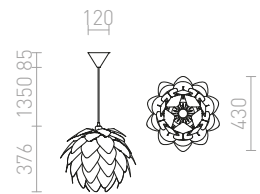

## COCO

Lampada a sospensione decorativa composta da elementi in plastica con disegno a bocciolo di rosa. Fornita non assemblata, è necessario completarla.

### COCO A SOSPENSIONE

230 V E27 28 W

**R12384** PVC bianco

€ 220



G13026

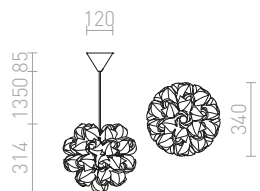



## CONFETTI

Lampadario giocoso con strati di confetti circolari da pellicola cromata. Viene fornita non assemblata, è necessario completarla.

### CONFETTI A SOSPENSIONE

230 V E27 28 W

R13285 pellicola cromata

€ 88

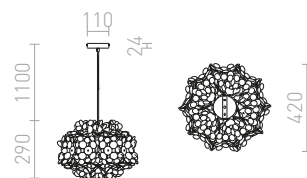
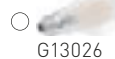





## ZALA

Lampada a sospensione con strisce di plastica decorative. Fornita non assemblata, è necessario completarla.

### ZALA A SOSPENSIONE

230 V E27 15 W

R13315 PVC bianco/nero

€ 48 %

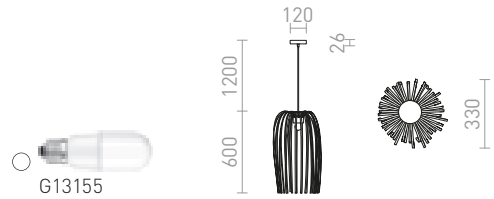

## RARA

Lampada a sospensione con strisce di plastica decorative. Fornita non assemblata, è necessario completarla.

### RARA A SOSPENSIONE

230 V E27 15 W

R13316 PVC bianco/nero

€ 48 %

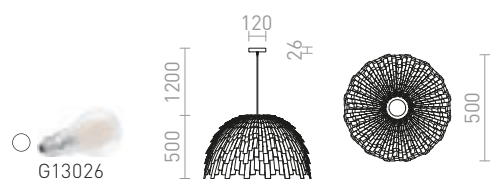

**CLANK**

Lampada a sospensione con strisce di plastica decorative. Viene fornita non assemblata, è necessario completarla.

**CLANK A SOSPENSIONE**

230 V E27 15 W

R13321 PVC bianco/nero

€ 68 %

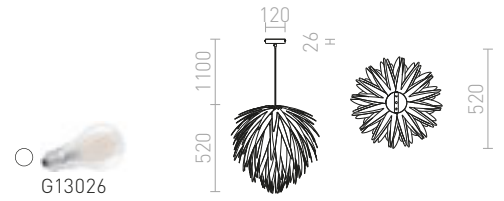
**EZRA**

Lampada a sospensione con paralume circolare decorativo a fossette. Viene fornita non assemblata, è necessario completarla.

**EZRA 40 A SOSPENSIONE**

230 V E27 15 W

R13319 PVC bianco/grigio

€ 48 %

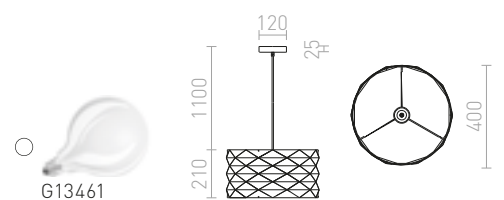



## JAMAICA

Lampada a sospensione con paralume intrecciato di materiale naturale, forma conica.

### JAMAICA 34 A SOSPENSIONE

230 V E27 15 W

R13397 naturale

€ 78

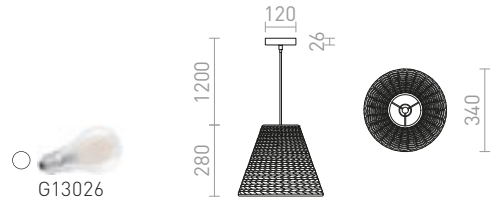

## POLLOCK

Paralume a sospensione con diffusore incassato grigio.

### POLLOCK A SOSPENSIONE

230 V E27 28 W

R13280 bianco/grigio chiaro

€ 68

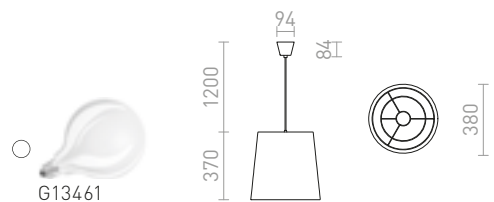



## VESCO

Apparecchio a sospensione con paralume in metallo laccato.

### VESCO A SOSPENSIONE

230 V E27 42 W

R10536 nero

€ 129 %

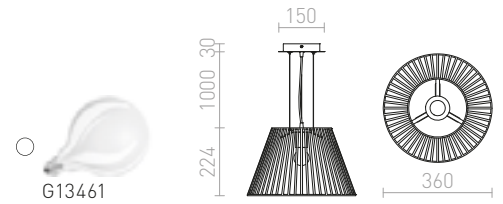

## BUCKY

Lampada a sospensione in metallo con decoro stropicciato.

### BUCKY 40 A SOSPENSIONE

230 V E27 28 W

R13360 bianco/grigio/metallo

€ 129 %

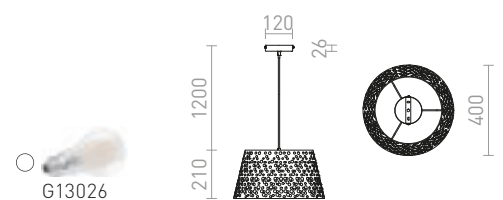





## ESPLANADE

Lampada a sospensione con doppio paralume in tessuto.

### ESPLANADE A SOSPENSIONE

230 V E27 42 W

R12483 nero trasparente/bianco/cromo

€ 335



G13029

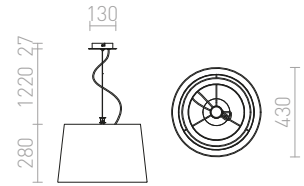





## AMICI

Lampada a sospensione con paralume in silicone modellabile.

### AMICI A SOSPENSIONE IN SILICONE

230 V E27 42 W

R10620 verde

€ 10.50

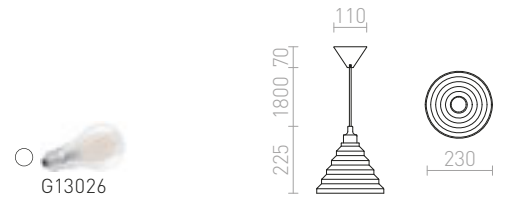

## CHOUPELLE

Apparecchio a sospensione tessile con decorazione in legno, compatibile con sorgente LED E27.

### CHOUPELLE A SOSPENSIONE

230 V E27 15 W

R13650 grigio nerastro/tessuto/legno

€ 120

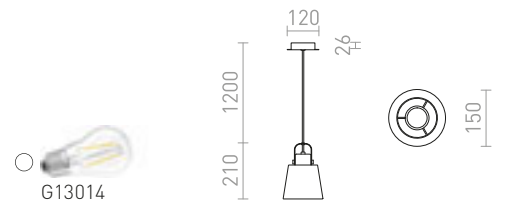

## ICAR

Lampada a sospensione minimalista con paralume tessile.

### ICAR A SOSPENSIONE

230 V E27 15 W

R12418 nero/oro

€ 120

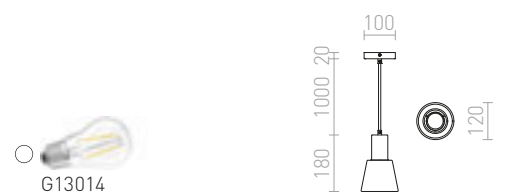

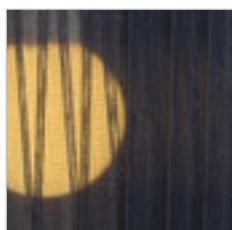

## FIATLUX

Lampada a sospensione con paralume di bambù in colore nero.

### FIATLUX 41/24 A SOSPENSIONE

230 V E27 15 W

R13398 nero/bambù

€ 88 

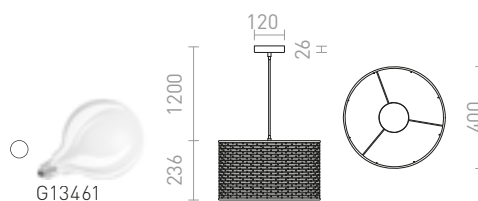

## GLAMOUR

Lampada a sospensione con paralume con nastri neri.

### GLAMOUR 35/20 A SOSPENSIONE

230 V E27 28 W

R13271 nero

€ 48 

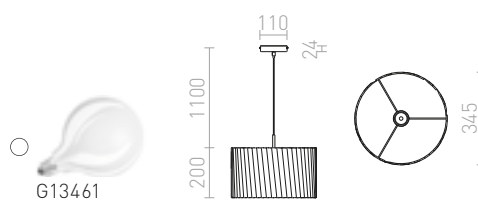



## FANCY

Lampada a sospensione decorativa con paralume pellicola cromata. La luce spenta da effetto speculare, accesa è parzialmente trasparente.

### FANCY 35/25 A SOSPENSIONE

230 V E27 15 W

R13418 pellicola cromata

€ 120

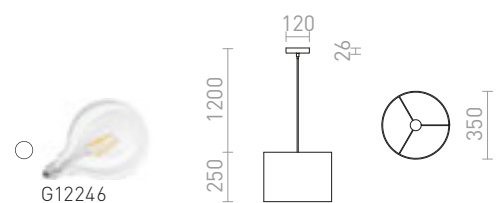

### FANCY 50/30 A SOSPENSIONE

230 V E27 20 W

R13419 pellicola cromata

€ 150

R13748 lamina fumé

€ 178

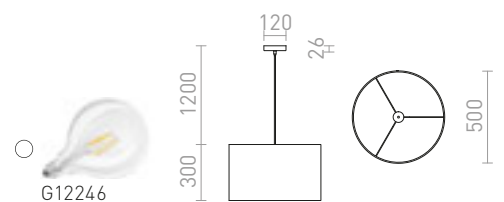



## AINO

Lampada a sospensione con motivo a maglia grigio.

### AINO 40 A SOSPENSIONE

230 V E27 28 W

R13275 grigio/cromo

€ 129

%

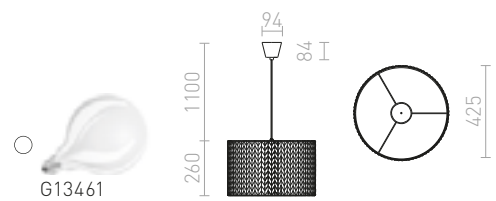



## LALO

Lampada a sospensione con paralume finemente pieghettato in colore panna. Per tre sorgenti luminose con portalampada E27 coperte con diffusore acrilico opaco.

### LALO 40 A SOSPENSIONE

230 V E27 3x42 W

R10605 bianco crema/nichel opaco

€ 215 %

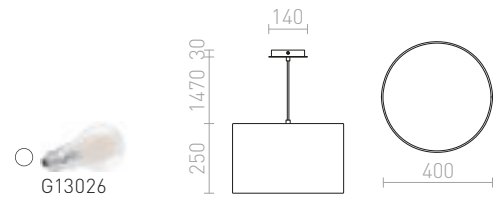

### LALO 55 A SOSPENSIONE

230 V E27 3x42 W

R10540 bianco crema/nichel opaco

€ 229 %

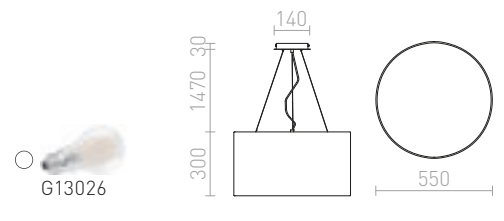

## LOPE

Lampada a sospensione con paralume nero, adatto per quattro sorgenti luminose con portalampada E27 che sono coperti da diffusore acrilico opaco.

### LOPE 80 A SOSPENSIONE

230 V E27 4x42 W

R10539 nero/nichel opaco

€ 120 %

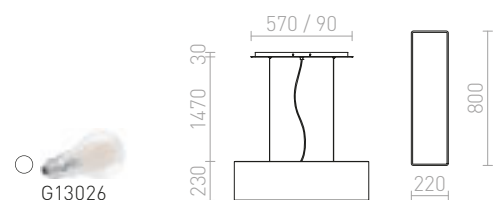



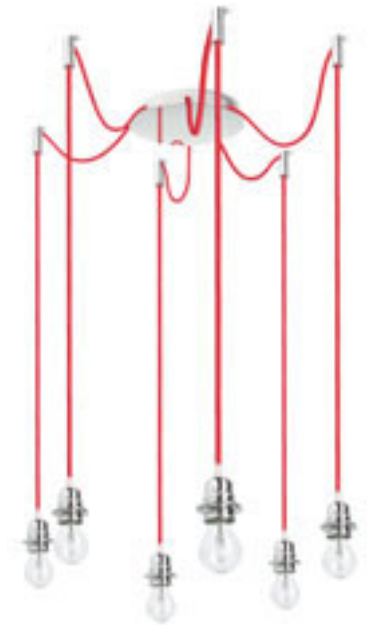

Diverse varianti dei set da appendere **KOMBIX** troverete in categoria **Paralumi ed accessori**.



## CINDY

Lampada a sospensione con base per soffitto centrale e sei cavi di sospensione per lampadine con portalampada E27. Cavi di sospensione forniti con fermacavi da soffitto con possibilità di scegliere la distanza individuale dalla base. La lunghezza totale del cavo è 2m.

### CINDY VI A SOSPENSIONE

230 V E27 6x42 W

**R12054** nero

**€ 238**

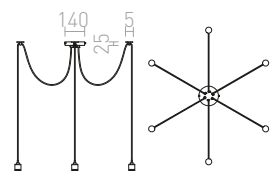



## ASTRAL

Lampada a sospensione di design con paralumi in vetro bicolore. I paralumi possono essere combinati in varie forme. L'anello decorativo viene usato per aggiustare l'inclinazione delle lampade.

### ASTRAL A SOSPENSIONE

230 V/12 V G4 10x20 W

**R10513** vetro cromato/vetro trasparente

€ 560

**R11706** vetro in rame/vetro trasparente

€ 645



G13035

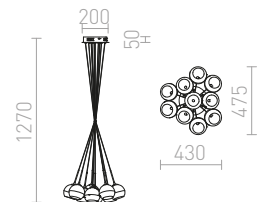

## ASTROMET

Lampada a sospensione costituita da sette sfere cromate connesse ad una base per soffitto con portalampada E27.

### ASTROMET VII A SOSPENSIONE

230 V E27 7x42 W

**R11761** cromo

€ 320



G13014

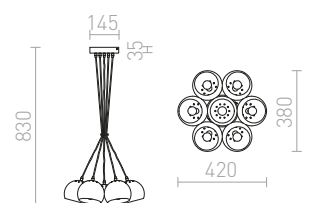







## BEAU MONDE

Apparecchio a sospensione con paralume in vetro soffiato a mano. L'aspetto speculare del paralume è ottenuto con metodo speciale in cui un sottile strato di metallo viene applicato al vetro. Per lampade a risparmio energetico con portalampada E27. Le piccole bolle in vetro sono un risultato del processo di produzione, non si tratta di un difetto.

### BEAU MONDE 25 A SOSPENSIONE

230 V E27 25 W

R10517 vetro in rame

€ 198

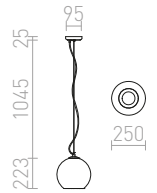

## BEAU MONDE

Apparecchio a sospensione con paralume in vetro soffiato a mano. L'aspetto speculare del paralume è ottenuto con metodo speciale in cui un sottile strato di metallo viene applicato al vetro. Per lampade a risparmio energetico con portalampada E27. Le piccole bolle in vetro sono un risultato del processo di produzione, non si tratta di un difetto.

### BEAU MONDE 30 A SOSPENSIONE

230 V E27 25 W

R10518 vetro cromato

€ 278

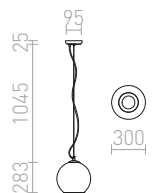

## BEAU MONDE

Apparecchio a sospensione con paralume in vetro soffiato a mano. L'aspetto speculare del paralume è ottenuto con metodo speciale in cui un sottile strato di metallo viene applicato al vetro. Per lampade a risparmio energetico con portalampada E27. Le piccole bolle in vetro sono un risultato del processo di produzione, non si tratta di un difetto.

### BEAU MONDE 35 A SOSPENSIONE

230 V E27 25 W

R10516 vetro cromato/vetro trasparente

€ 320

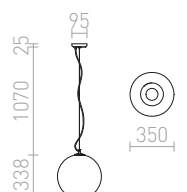



IP44

## BOLLY

Apparecchio a sospensione in vetro opalino e accessori cromati. Adatto per ambienti umidi.

### BOLLY 17 A SOSPENSIONE

230 V LED E27 15 W IP44

R13692 vetro opalino/cromo

€ 178



G13307

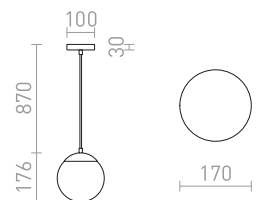



## LUNA

Lampada a sospensione in vetro opalino con finiture cromate e cavo trasparente.

### LUNA 20 A SOSPENSIONE

230 V LED E27 15 W

R13745 vetro opalino/cromo

€ 120

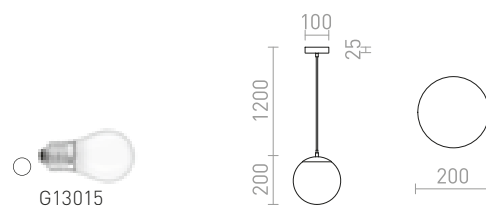

### LUNA 25 A SOSPENSIONE

230 V LED E27 15 W

R13746 vetro opalino/cromo

€ 150

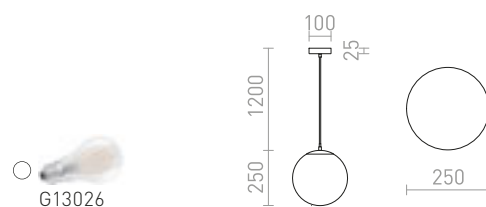

### LUNA 30 A SOSPENSIONE

230 V LED E27 15 W

R13747 vetro opalino/cromo

€ 198

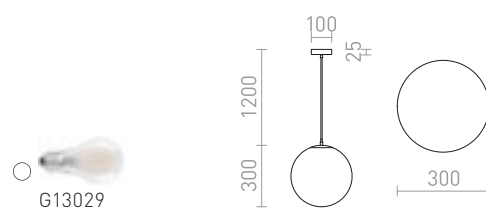



## LUNEA

Lampada a sospensione con paralume in triplice vetro opalino. Sospeso eccentricamente su corda per montaggio al di fuori dell'alimentazione elettrica. Cavo trasparente ed accessori cromati.

### LUNEA 30 A SOSPENSIONE TRIPLEX

230 V E27 70 W

**R10478** vetro opalino

**€ 178**

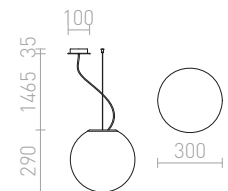

### LUNEA 40 A SOSPENSIONE TRIPLEX

230 V E27 70 W

**R10479** vetro opalino

**€ 320**

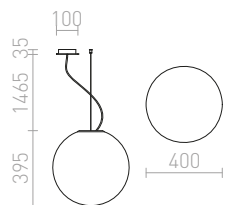

### LUNEA 50 A SOSPENSIONE TRIPLEX

230 V E27 100 W

**R11715** vetro opalino

**€ 450**

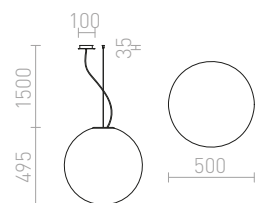









## BABU NEW

Apparecchio a sospensione con paralume in vetro e base per soffitto cromata. Disponibile in due varianti di colore.

### BABU NEW 22 A SOSPENSIONE

230 V E27 53 W

**R13826** vetro trasparente/cromo

€ 178

**R13827** vetro opalino/cromo

€ 178

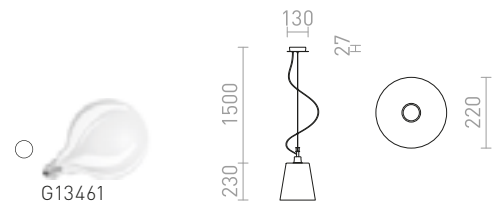

## JULIETTA

Lampada di design a sospensione con vetro cilindrico opalino. Elementi in metallo verniciato, cavo in tessuto nero.

### JULIETTA 16 A SOSPENSIONE

230 V E27 20 W

**R13752** vetro opalino/nero

€ 120

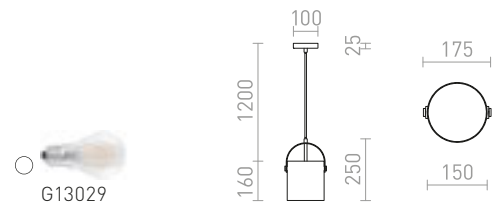

### JULIETTA 31 A SOSPENSIONE

230 V E27 20 W

**R13753** vetro opalino/nero

€ 158

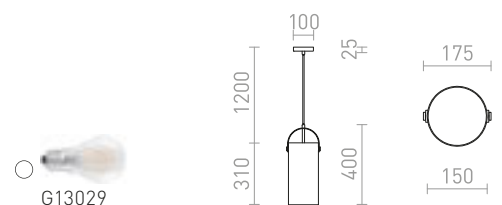



## BELLINI

Lampada a sospensione in vetro con accessori laccati, adatta per sorgente luminosa LED con portalampada E14.

### BELLINI L E14 A SOSPENSIONE

230 V E14 15 W

R13658 bianco/vetro trasparente

€ 178

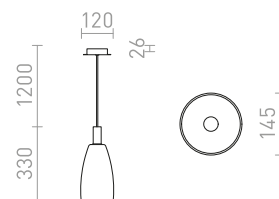

## BELLINI

Apparecchio LED a sospensione in vetro di design. Adatto per posizionare sopra i banconi del bar e le isole della cucina.

### BELLINI M LED A SOSPENSIONE

230 V LED 5 W  $\angle 30^\circ$  3000 K 475 lm Ra 80

R13652 nero/vetro fumé

€ 198

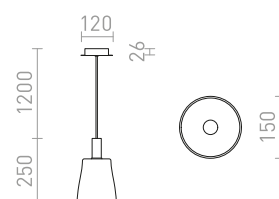





## AZRIA

Lampada a sospensione elegante con vetro strutturato e accessori cromati.

### AZRIA A SOSPENSIONE

230 V G9 25 W

R12056 vetro fumé

€ 78 %

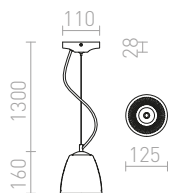

## CORONA

Apparecchio a sospensione con vetro massiccio strutturato. Il vetro è cromato su entrambi i lati. Se acceso, la sorgente luminosa risulta parzialmente visibile.

### CORONA A SOSPENSIONE

230 V E27 42 W

R12055 vetro cromato

€ 215 %

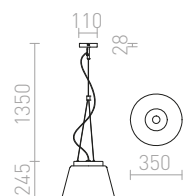



## COROA NEW 28

Apparecchio a sospensione con paralume in due varianti di colore. Base per soffitto cromata.

### COROA NEW 28 A SOSPENSIONE

230 V E27 53 W

**R13824** vetro opalino/cromo

€ 220

**R13825** nero/cromo

€ 258

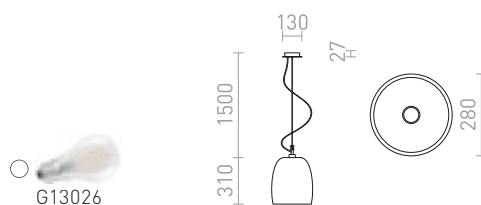

## PULIRE

Lampada retrò a sospensione in vetro bianco latte per lampadina con portalampada E14.

### PULIRE CON A SOSPENSIONE

230 V E14 28 W

**R12663** vetro opalino/legno/cromo

€ 98

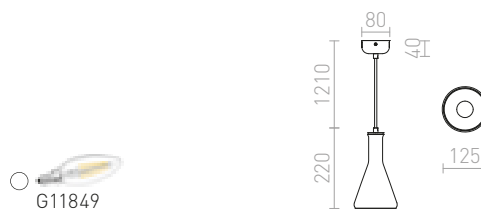

### PULIRE RD A SOSPENSIONE

230 V E14 28 W

**R12664** vetro opalino/legno/cromo

€ 98







## SANSSOUCI

Apparecchio a sospensione con paralume in vetro.  
A luce spenta si ha un effetto speculare, a luce accesa  
sorgenti luminose sono parzialmente visibili.

### SANSSOUCI I A SOSPENSIONE

230 V E27 42 W

**R10511** vetro in rame

€ 98 →

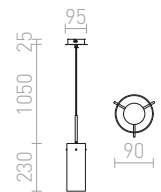

### SANSSOUCI I A SOSPENSIONE

230 V E27 42 W

**R10509** vetro cromato

€ 98 →

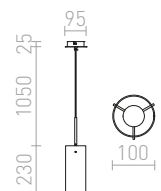



## GARNISH

Lampada a sospensione con base cromata e paralume in vetro trasparente. Il paralume di vetro è chiuso in basso ed è possibile inserire delle decorazioni adatte.

### GARNISH A SOSPENSIONE

230 V GU10 9 W

**R11756** vetro trasparente/cromo

€ 138



G11837

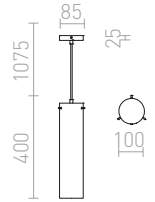

## EIGHT

Lampada a sospensione con paralume in vetro opalino ed accessori cromati.

### EIGHT A SOSPENSIONE

230 V E27 28 W

**R10493** vetro opalino/cromo

€ 129



G13155

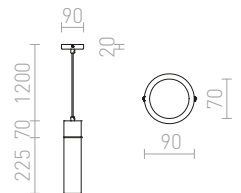

## TOMBA

Lampada a sospensione cilindrica in vetro con accessori cromati per tre tubi fluorescenti lineari.

### TOMBA A SOSPENSIONE

230 V G5 3x21 W

**R10501** vetro opalino/cromo

€ 278

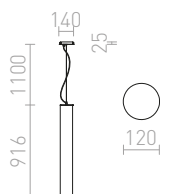
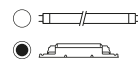







## GIFT

Lampada a sospensione con paralume in vetro strutturato trasparente. Accessori in cromo.

### GIFT I A SOSPENSIONE

230 V E14 42 W

**R10510** vetro trasparente/cromo

€ 88 ➔

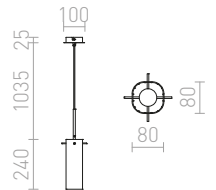

## ESTRA

Lampada a sospensione LED con riflettori dentati in alluminio laccato, coperti con paralume in vetro trasparente.

### ESTRA V A SOSPENSIONE

230 V LED 5x5 W 3000 K 2000 lm Ra 81

**R11678** bianco/vetro trasparente

€ 335 %

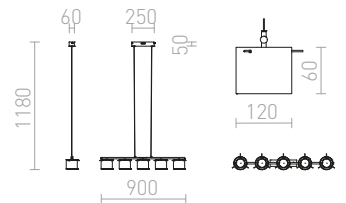
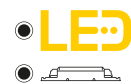

### ESTRA I A SOSPENSIONE

230 V LED 5 W 3000 K 400 lm Ra 81

**R11679** bianco/vetro trasparente

€ 78 %

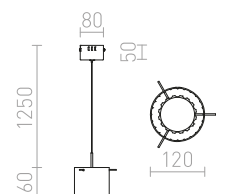



## LIZ NEW

Apparecchio a sospensione con paralume in vetro, disponibile in due varianti di colore.

### LIZ NEW A SOSPENSIONE

230 V E27 28 W

**R13822** vetro opalino/cromo

€ 98

**R13823** nero/cromo

€ 98

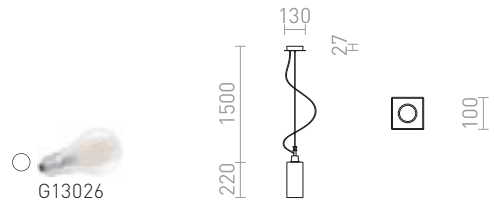

## LIZ NEW

Lampada a sospensione lineare con paralumi in vetro per sorgenti luminose a LED con filettatura E27. Adatta per essere collocata sopra il tavolo da pranzo.

### LIZ III 60 A SOSPENSIONE

230 V LED E27 3x11 W

**R14023** vetro opalino/nichel opaco

€ 150 NEW

**R14024** vetro opalino/cromo

€ 150 NEW

**R14025** nero/vetro/nichel opaco

€ 158 NEW

**R14026** nero/vetro/cromo

€ 158 NEW

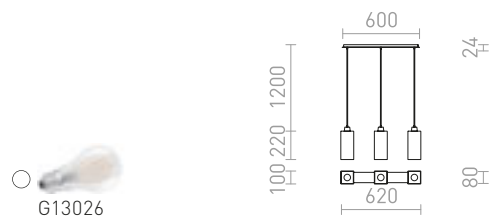

### LIZ III 80 A SOSPENSIONE

230 V LED E27 3x11 W

**R14027** vetro opalino/nichel opaco

€ 178 NEW

**R14028** vetro opalino/cromo

€ 178 NEW

**R14029** nero/vetro/nichel opaco

€ 178 NEW

**R14030** nero/vetro/cromo

€ 178 NEW

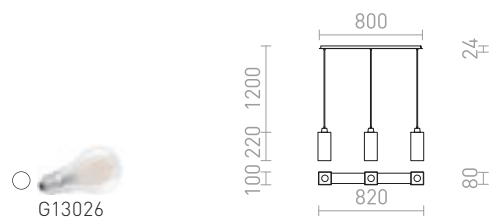





### DADOS NEW

Apparecchio a sospensione con paralume in vetro opalino e base per soffitto cromata.

#### DADOS NEW A SOSPENSIONE

230 V E27 28 W

R13821 vetro opalino/cromo

€ 98

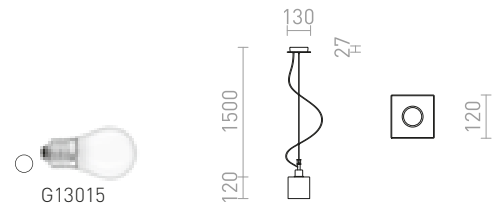

### DADOS NEW

Lampada a sospensione lineare con paralumi in vetro per sorgenti luminose a LED con filettatura E27. Adatta per essere collocata sopra il tavolo da pranzo.

#### DADOS III 60 A SOSPENSIONE

230 V LED E27 3x11 W

R14019 vetro opalino/nichel opaco

€ 150

NEW

R14020 vetro opalino/cromo

€ 150

NEW

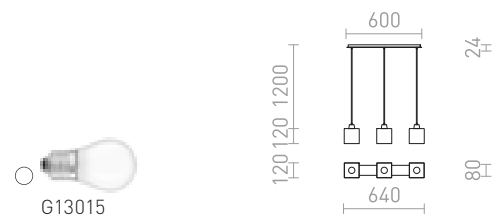

#### DADOS III 80 A SOSPENSIONE

230 V LED E27 3x11 W

R14021 vetro opalino/nichel opaco

€ 178

NEW

R14022 vetro opalino/cromo

€ 178

NEW

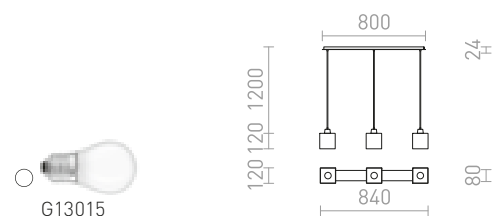



## BROADWAY

Lampada a sospensione con paralume scorrevole sulla corda con altezza regolabile e con cavo per la presa. Adatto per spazi senza alimentazione al soffitto. Paralume è coperto da tessuto strutturato e l'interruttore si trova sul cavo di alimentazione.

### BROADWAY A SOSPENSIONE SCORREVOLE

230 V E27 42 W

R11989 bianco/cromo

€ 178 %

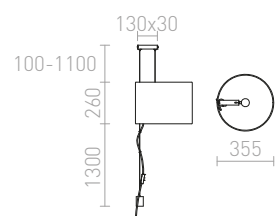



## LEVITA

Lampada a sospensione a saliscendi con paralume in versione nera / bianca.

### LEVITA A SOSPENSIONE REGOLABILE

230 V E27 42 W

**R12477** bianco/cromo

€ 420

**R12478** nero/cromo

€ 420

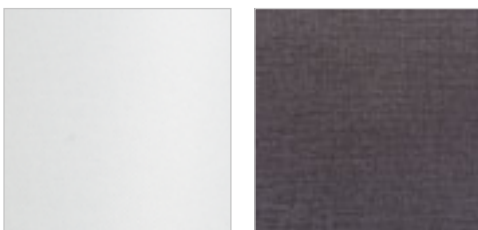

G13029

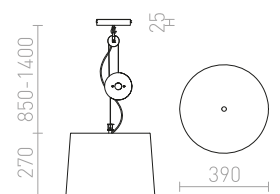



## BROADWAY

Lampada a sospensione con braccio regolabile su asse di soffitto. Fornita con paralume di tessuto strutturato.

### BROADWAY A SOSPENSIONE CON BRACCIO

230 V E27 42 W

R11978 bianco/cromo

€ 720 %

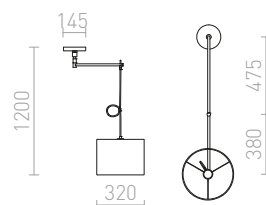
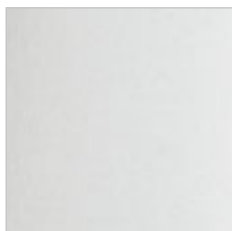
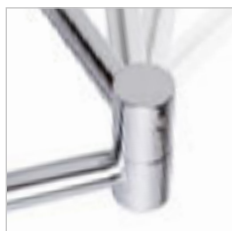

## MADISON

Lampada da soffitto con doppio braccio posizionabile e paralume in tessuto.

### MADISON C DA SOFFITTO

230 V E27 42 W

R12479 bianco/cromo

€ 560 ▶

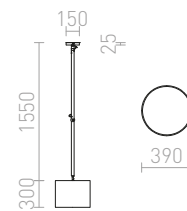







## LOYD LED

Apparecchio da soffitto con LED integrato, flessibile in tutte le direzioni con paralume in tessuto.

### LOYD LED I A SOSPENSIONE

230 V LED 4,5 W 3000 K 280 lm Ra 80

R12932 nero/nichel opaco

€ 88 %

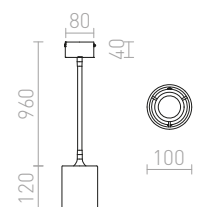



### LOYD E27 I

Apparecchio da soffitto con braccio flessibile rivestito in silicone, regolabile in tutte le direzioni. Da utilizzare con sorgenti luminose decorative o riflettori con portalampada E27.

#### LOYD E27 I A SOSPENSIONE

230 V E27 28 W

**R12933** grigio beige

€ 88

**R12934** nero

€ 88



G13461

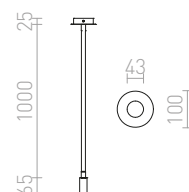

### LOYD E27 III

Apparecchio da soffitto triplo con bracci flessibili rivestiti in silicone, regolabili in tutte le direzioni. Da utilizzare con sorgenti luminose decorative o riflettori con portalampada E27.

#### LOYD E27 III A SOSPENSIONE

230 V E27 3x28 W

**R12935** nero

€ 188



G12246

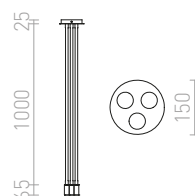







## GIULIA

Lampada a sospensione in metallo verniciato con cavo di tessuto.

### GIULIA 12 A SOSPENSIONE

230 V E27 40 W

**R13908** bianco/cromo

€ 58 NEW

**R13909** nero/marrone dorato/ottone

€ 58 NEW

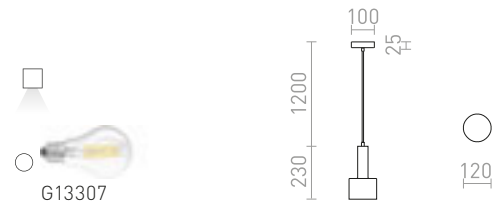

### GIULIA 20 A SOSPENSIONE

230 V E27 40 W

**R13910** bianco/cromo

€ 68 NEW

**R13911** nero/marrone dorato/ottone

€ 68 NEW

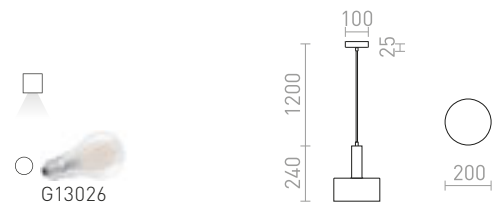

### GIULIA 40 A SOSPENSIONE

230 V E27 40 W

**R13912** bianco/cromo

€ 138 NEW

**R13913** nero/marrone dorato/ottone

€ 138 NEW

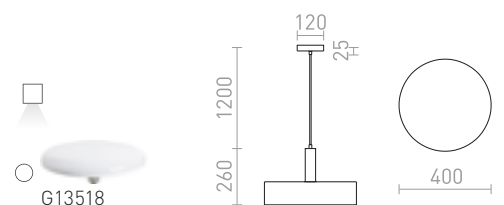



## STIG

Elegante apparecchio LED a sospensione adatto per l'illuminazione di banconi da bar o isole da cucina.

### STIG A SOSPENSIONE

230 V LED 6,8 W  $\angle 34^\circ$  3000 K 466 lm Ra 80

R13940 nero

€ 88

NEW

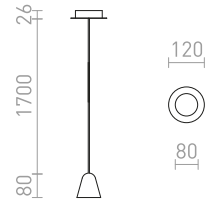
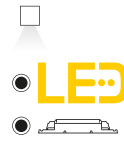

## RIGA

Tubo a sospensione con LED integrato.

### RIGA 28 A SOSPENSIONE

230 V LED 6 W  $\angle 38^\circ$  3000 K 570 lm Ra 80

R12458 bianco

€ 98

R12459 nero

€ 98

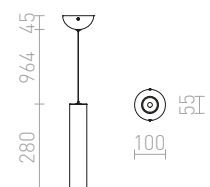
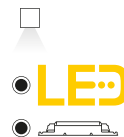

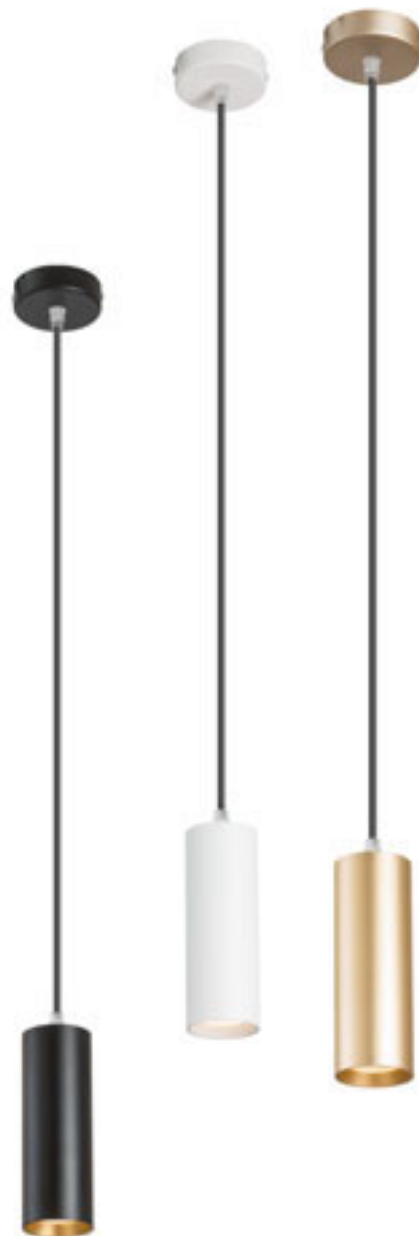

## MAVRO

Faretto a sospensione LED a tubo elegante, adatto per posizionare sopra i banconi del bar e le isole della cucina. Dimmerazione TRIAC.

### MAVRO DIMM A SOSPENSIONE

230 V LED 12 W  $\angle 38^\circ$  3000 K 1020 lm Ra 80

**R13182** bianco

€ 178

**R13183** oro

€ 178

**R13184** nero/oro

€ 178

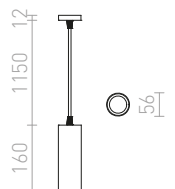

## MAVRO

Faretto a sospensione LED a tubo elegante, adatto per posizionare sopra i banconi del bar e le isole della cucina.

### MAVRO A SOSPENSIONE

230 V LED 12 W  $\angle 38^\circ$  3000 K 1020 lm Ra 80

**R12990** bianco

€ 120

**R12991** oro

€ 120

**R12992** nero/oro

€ 120

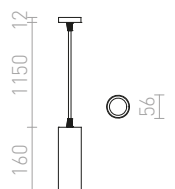
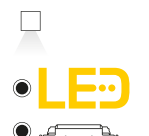



## BOGARD

Faretto a sospensione cilindrico con LED integrato. Paralume può essere otticamente prolungato con estensione R12495 e R12496.

### BOGARD A SOSPENSIONE

230 V LED 5 W  $\angle 40^\circ$  3000 K 350 lm Ra 80

R12493 nero opaco

€ 98

R12494 nichel opaco

€ 78

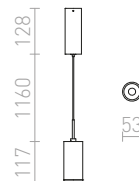
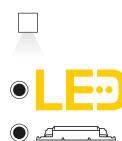

## BOGARD

Estensione per lampade a sospensione BOGARD R12493 e R12494.

### BOGARD ESTENSIONE PER LAMPADA A SOSPENSIONE

R12495 nero opaco

€ 13.50

R12496 nichel opaco

€ 13.50

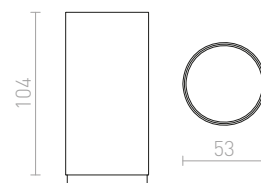

## BELENOS

Faretto cilindrico semplice sospeso, per sorgenti luminose con portalampada GU10. Le molle fissate alla base consentono l'uso di sorgenti luminose di varie lunghezze.

### BELENOS A SOSPENSIONE

230 V LED GU10 9 W

R13365 bianco

€ 58

R13366 nero

€ 58

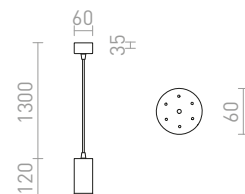





## OPTIMUS

Apparecchio a sospensione cilindrico con la possibilità di regolare il cono di luce tramite il sistema di zoom 10-50°. L'apparecchio è adatto per sorgenti luminose LED con portalampada GU10. Da usare con sorgenti luminose con fascio di luce di 120° per evitare ombre indesiderate.

### OPTIMUS A SOSPENSIONE

230 V LED GU10 9 W  $\angle$ 10-50°

**R13777** bianco

€ 58

**R13778** nero

€ 58

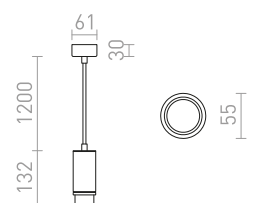



## AGNETA

Lampada a sospensione rotonda in metallo da utilizzare con una lampadina E27.

### AGNETA A SOSPENSIONE

230 V E27 40 W

**R13897** bianco

€ 58 NEW

**R13898** nero

€ 58 NEW

**R13899** ottone spazzolato

€ 88 NEW

**R13900** rame spazzolato

€ 88 NEW

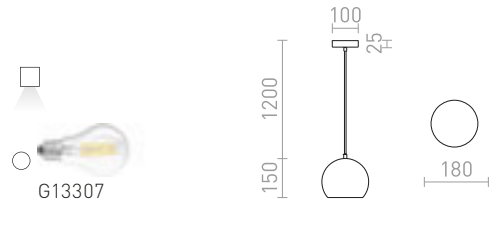

## ARAQ

Apparecchio a sospensione con portalampada in ottone, cavo tessile e base verniciata nera. Adatto per lampadine decorative con attacco E27.

### ARAQ A SOSPENSIONE

230 V E27 42 W

**R13891** ottone spazzolato/nero

€ 35 NEW

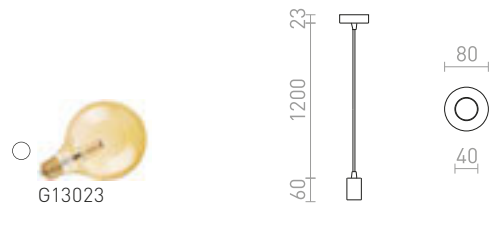

## DESTY

Lampada a sospensione con paralume e base soffitto in cromo o rame. Versione in cromo viene fornita con cavo di tessuto nero e la versione rame con cavo di tessuto rosso.

### DESTY I A SOSPENSIONE

230 V GU10 35 W

**R12085** rosso/rame

€ 78 →

**R12086** nero/cromo

€ 78 →

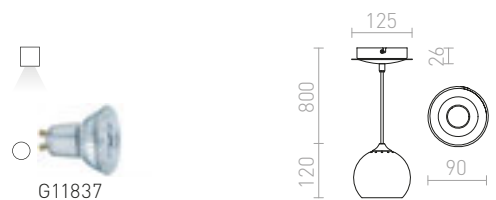



## COPA

Apparecchio a sospensione con paralume in vetro.  
Disponibile in due colori.

### COPA A SOSPENSIONE

230 V E27 28 W

**R11823** vetro opalino

€ 178

**R11824** nero/vetro

€ 178



G13014

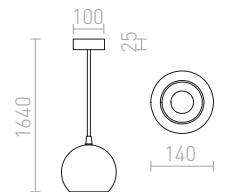



## ASTON

Lampada a sospensione in metallo con cavo trasparente, per sorgenti luminose a base E27.

### ASTON 28 A SOSPENSIONE

230 V E27 42 W

R10515 alluminio spazzolato

€ 68 %

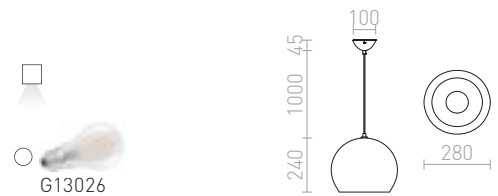

### ASTON 30 A SOSPENSIONE

230 V E27 42 W

R12394 cromo

€ 98 %

R12395 rame

€ 120 %

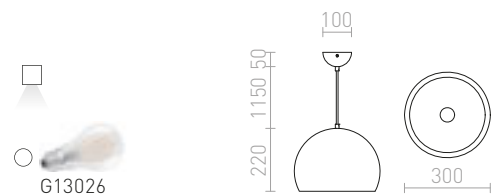



## MARGO

Lampada a sospensione cromata con LED integrato, la luce viene dispersa dal diffusore in acrilico latte. Diffusore con montatura di alluminio.

### MARGO SOSPENSIONE

230 V LED 7 W 3000 K 700 lm Ra 80

R10578 cromo

€ 48 %

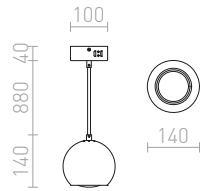

## BLONDIE

Apparecchio a sospensione con paralume in metallo ammassato. L'esterno del paralume è di color rame e l'interno è laccato in bianco. Cavo in PVC nero e copribase per soffitto in color rame fa parte della fornitura.

### BLONDIE 25 A SOSPENSIONE

230 V E27 42 W

R12057 rame

€ 198



G13461

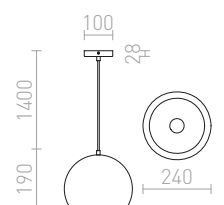







## SINTRA

Lampada a sospensione con paralume in metallo cromato, disponibile in due dimensioni.

### SINTRA 30 A SOSPENSIONE

230 V E27 42 W

R11698 cromo

€ 58 %

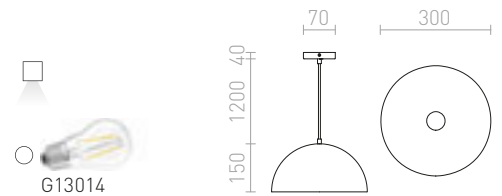

### SINTRA 40 A SOSPENSIONE

230 V E27 42 W

R11699 cromo

€ 120 %

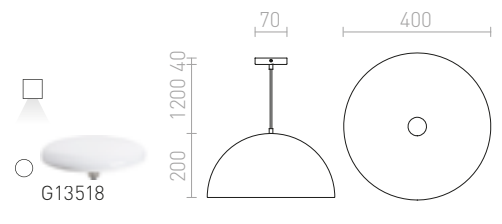

## MONROE

Apparecchio a sospensione con paralume in metallo disponibile in due dimensioni.

### MONROE 30 A SOSPENSIONE

230 V E27 42 W

R11700 nero opaco/bianco

€ 150

R12396 rame

€ 120 %

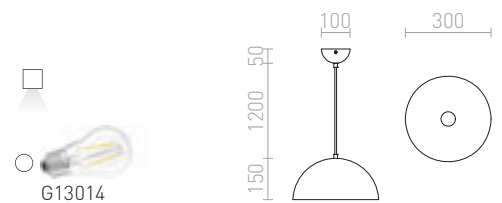

### MONROE 40 A SOSPENSIONE

230 V E27 42 W

R11701 nero opaco/bianco

€ 215

R11707 bianco lucido/bianco

€ 215

R12397 rame

€ 150 %

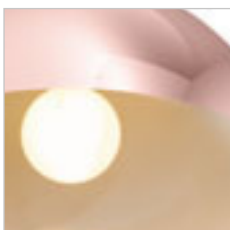
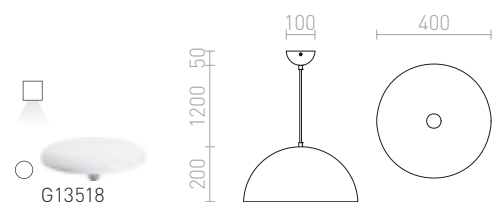



## CARISSIMA

Lampada a sospensione con paralume in metallo laccato o cromato. L'interno del paralume è in colore d'oro o grigio-argento.

### CARISSIMA 25 A SOSPENSIONE

230 V E27 28 W

R11765 cromo

€ 58 %



### CARISSIMA 40 A SOSPENSIONE

230 V E27 42 W

R11766 nero opaco/oro

€ 220

R13048 bianco opaco/grigio argento

€ 220

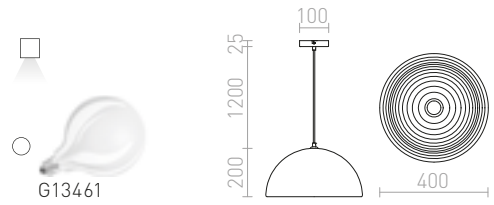

## BABADES

Lampada a sospensione con paralume e base soffitto in cromo o nichel opaco. Fornito con cavo in tessuto nero.

### BABADES IV A SOSPENSIONE

230 V GU10 4x35 W

R12083 cromo

€ 215 ▶

R12084 nichel opaco

€ 215 ▶

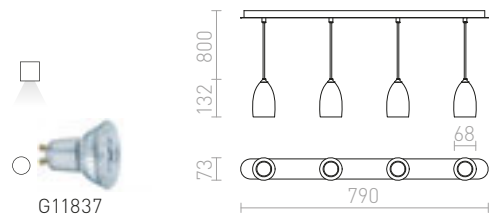

### BABADES I A SOSPENSIONE

230 V GU10 35 W

R12081 cromo

€ 58 ▶

R12082 nichel opaco

€ 58 ▶

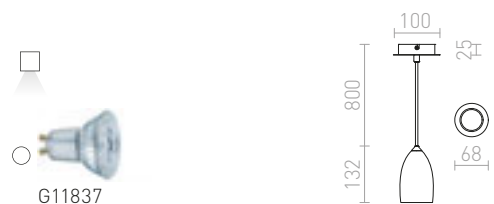









## GOLDIE

Apparecchio a sospensione in metallo disponibile in tre varianti di colore.

### GOLDIE 36 A SOSPENSIONE

230 V E27 42 W

|                             |       |   |
|-----------------------------|-------|---|
| <b>R11687</b> cromo         | € 120 | % |
| <b>R11688</b> nero/bianco   | € 178 |   |
| <b>R11689</b> bianco/bianco | € 88  | % |



### GOLDIE 46 A SOSPENSIONE

230 V E27 42 W

|                             |       |   |
|-----------------------------|-------|---|
| <b>R11690</b> nero/bianco   | € 220 |   |
| <b>R11691</b> bianco/bianco | € 215 |   |
| <b>R11692</b> cromo         | € 158 | % |

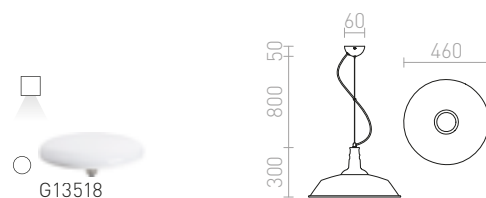

## MERYLYN

Lampada a sospensione conica in metallo per lampadina E27.

### MERYLYN 48 A SOSPENSIONE

230 V E27 42 W

|   |       |   |
|---|-------|---|
| <b>R12446</b> alluminio spazzolato/lacca dorata | € 150 | ➤ |
| <b>R12447</b> nero/bianco                       | € 150 | ➤ |

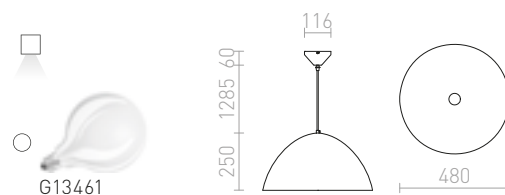



## MEZZO

Plafoniera a diodo LED con cornice in alluminio laccato. Il diffusore della luce è incluso nel policarbonato bianco latte. Possibilità di versione a sospensione con set da sospensione. Dimmerazione TRIAC.

### MEZZO 80 DIMM DA SOFFITTO

230 V LED 100 W 3000 K 6400 lm Ra 80

R13334 bianco

€ 850

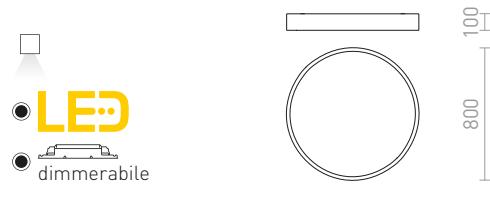

## MEZZO

Set da sospensione adatto per la serie MEZZO.

### MEZZO 80 SET DA SOSPENSIONE

230 V

R13335 bianco

€ 120

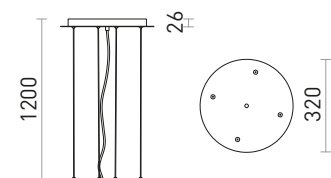



## MEZZO

Plafoniera a diodo LED con cornice in alluminio laccato. Il diffusore della luce è incluso nel policarbonato bianco latte. Possibilità di versione a sospensione con set da sospensione. Dimmerazione TRIAC.

### MEZZO 40 DIMM DA SOFFITTO

230 V LED 30 W 3000 K 1800 lm Ra 80

R13328 bianco

€ 258

R13329 nero

€ 258

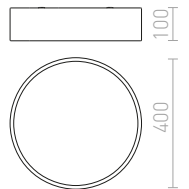

### MEZZO 60 DIMM DA SOFFITTO

230 V LED 60 W 3000 K 3700 lm Ra 80

R13332 bianco

€ 480

R13333 nero

€ 480

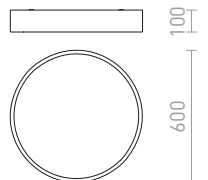

## MEZZO

Set da sospensione adatto per la serie MEZZO.

### MEZZO 40/60 SET DA SOSPENSIONE

230 V

R13330 bianco

€ 58

R13331 nero

€ 58

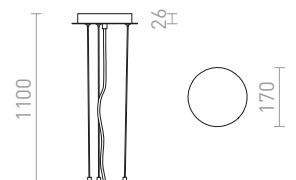



## ASTERI

Lampada a sospensione con paralume in vetro satinato. Vetro di copertura inferiore è fissato da un cerchio cromato piatto.

### ASTERI A SOSPENSIONE

230 V 2GX13 40 W

R10626 vetro satinato/cromo

€ 88 %

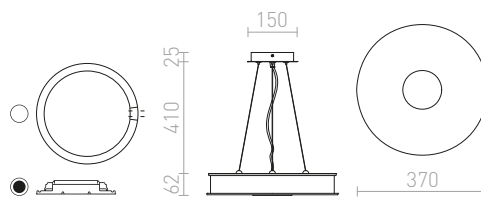

## CASSABLANCA

Apparecchio a sospensione adatto per due tubi fluorescenti circolari T5. La parte inferiore in vetro satinato è fissata con vite con tappo cromato. La parte laterale della lampada è in acrilico lattiginoso.

### CASSABLANCA 40 A SOSPENSIONE

230 V 2GX13 + 2GX13 22 W + 40 W

R10522 cromo

€ 120 %

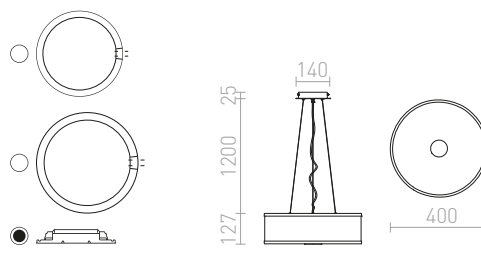

## LARISA

Lampada a sospensione circolare con LED integrato e montatura minimalista.

### LARISA R 30 A SOSPENSIONE

230 V LED 30 W 3000 K 2400 lm Ra 80

R12846 bianco

€ 98 %

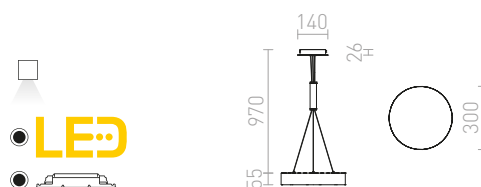



## MONETA

Lampada a sospensione elegante, metallica a LED. Diffusore in acrilico latteo laccato incluso. Dimmerazione TRIAC.

### MONETA DIMM A SOSPENSIONE

230 V LED 36 W 3000 K 2500 lm Ra 80

R10581 bianco

€ 290

%

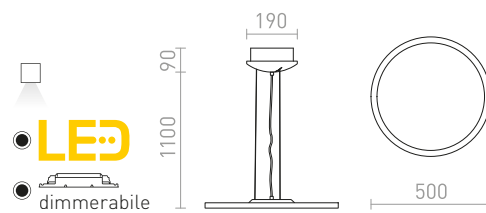





## MESA

Lampada LED a sospensione con montatura in alluminio laccato o spazzolato. Fornita con diffusore in acrilico bianco latte.

### MESA SQ 48 A SOSPENSIONE

230 V LED 56 W 3000 K 3530 lm Ra 80

R11291 bianco

€ 178

%

R11292 alluminio spazzolato

€ 178

%

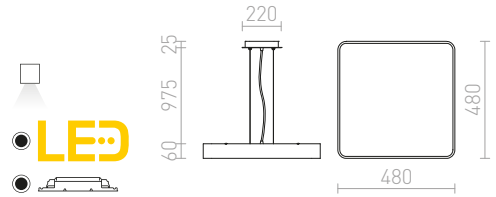



## MENSEA

Lampada a sospensione LED con montatura in alluminio laccato bianco. Fornita con diffusore in acrilico bianco latte.

### MENSEA RC A SOSPENSIONE

230 V LED 36 W 3000 K 2300 lm Ra 80

R10584 bianco

€ 150 %

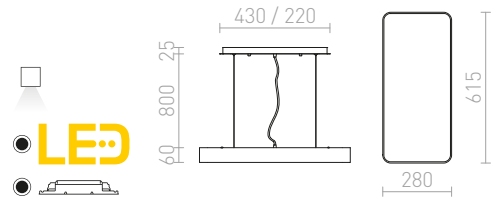

## LARISA

Plafoniera a sospensione quadrata a LED con montatura minimalista.

### LARISA SQ 30 A SOSPENSIONE

230 V LED 30 W 3000 K 2400 lm Ra 80

R12852 bianco

€ 88 %

R12853 nero

€ 88 %

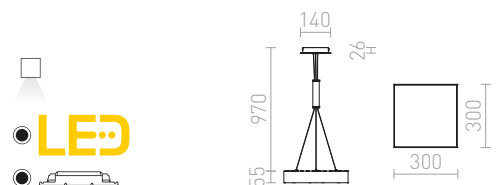





## STRUCTURAL

Apparecchio LED a sospensione da profilo in alluminio, design elegante in alluminio naturale o laccato in bianco, con il diffusore PMMA opalino, illuminazione diretta verso il basso, cavo tripolare trasparente.

### STRUCTURAL LED 20x20 A SOSPENSIONE

230 V LED 12 W 3000 K 900 lm Ra 80

R13709 alluminio spazzolato

€ 158 ➔

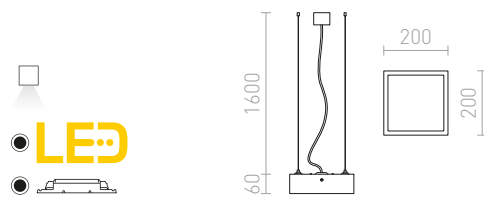

### STRUCTURAL LED 40x40 A SOSPENSIONE

230 V LED 36 W 3000 K 2600 lm Ra 80

R13710 bianco

€ 290 ➔

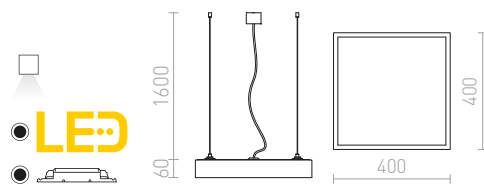

### STRUCTURAL LED 55x55 A SOSPENSIONE

230 V LED 48 W 3000 K 3600 lm Ra 80

R13713 bianco

€ 178 %

R13714 alluminio spazzolato

€ 258 %

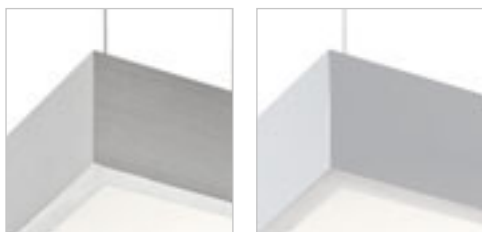
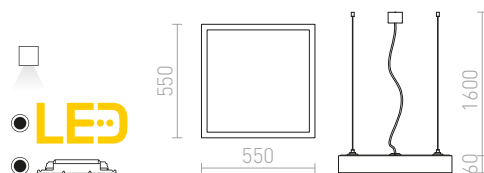









## PESANTE

LED profilo lineare a sospensione, adatto per interni moderni.

### PESANTE 35 A SOSPENSIONE

230 V LED 40 W 3000 K 3340 lm Ra 80

**R12718** alluminio anodizzato

€ 220

**R12719** nero

€ 229

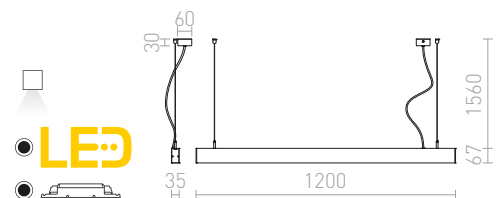

### PESANTE 75 A SOSPENSIONE

230 V LED 40 W 3000 K 4200 lm Ra 80

**R12720** alluminio anodizzato

€ 290

**R12721** nero

€ 320

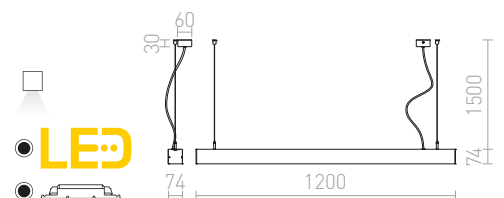



IP65

### TRIDENT PRO

Apparecchio lineare a LED industriale, adatto per montaggio a soffitto o per la sospensione con il set G13672. Potenza alta e la protezione IP65. Fornito senza il set da sospensione e senza cavo di alimentazione. Possibilità di connettere in serie.

#### TRIDENT PRO 120 CORPO

230 V LED 40 W 4000 K 5200 lm Ra 80 IP65

G13670 grigio/acrilato opaco

€ 58

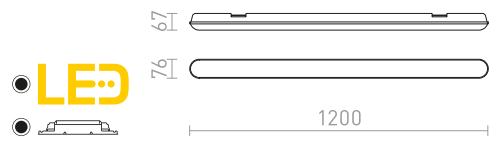

#### TRIDENT PRO 150 CORPO

230 V LED 60 W 4000 K 7800 lm Ra 80 IP65

G13671 grigio/acrilato opaco

€ 88

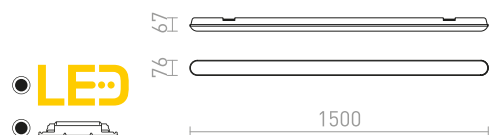



## TRIDENT PRO

Il set da sospensione per apparecchio Trident.

**TRIDENT PRO SET DA SOSPENSIONE 2 PEZZI**

**613672** nero

**€ 3.50**

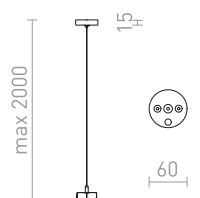

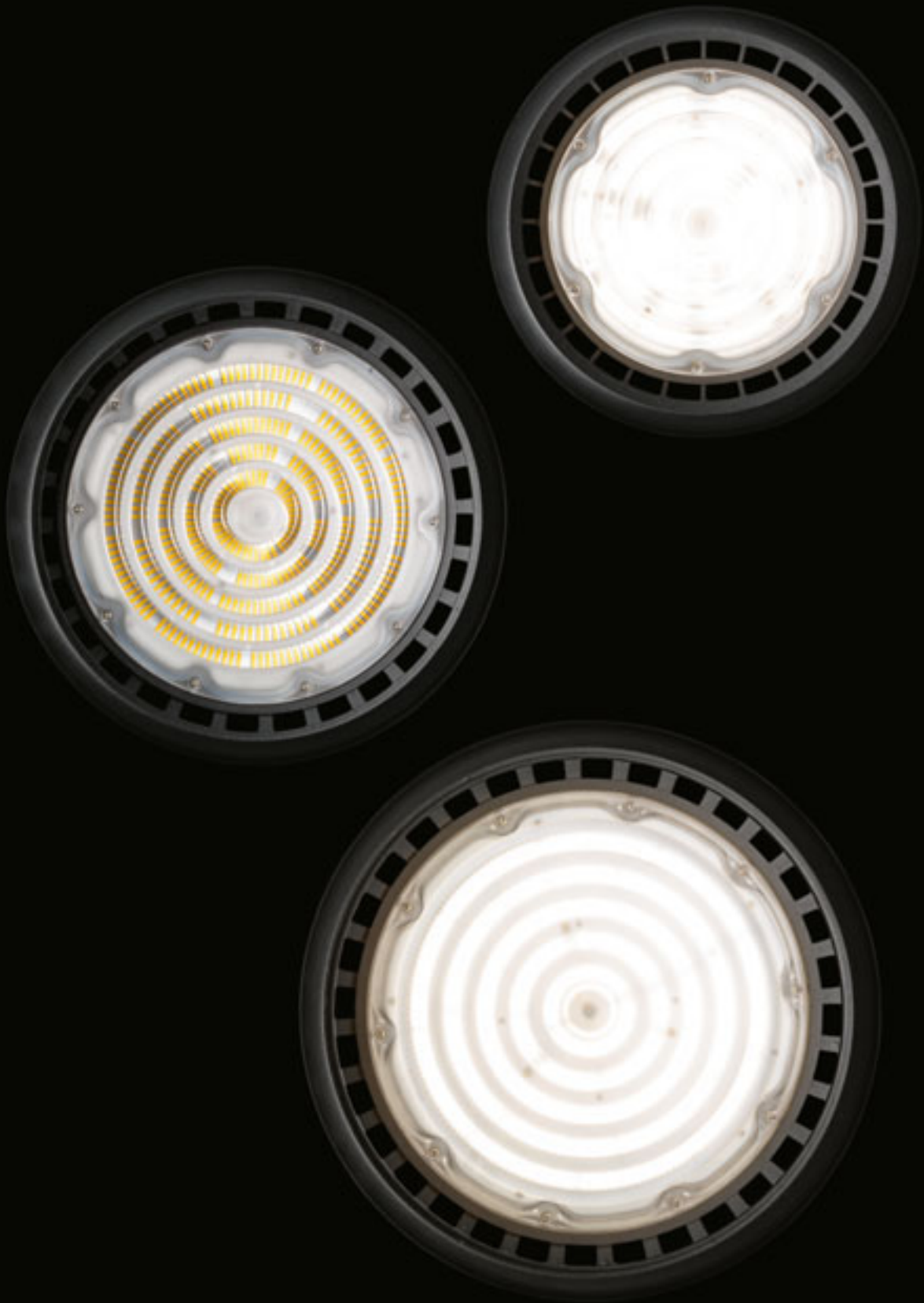





IP65

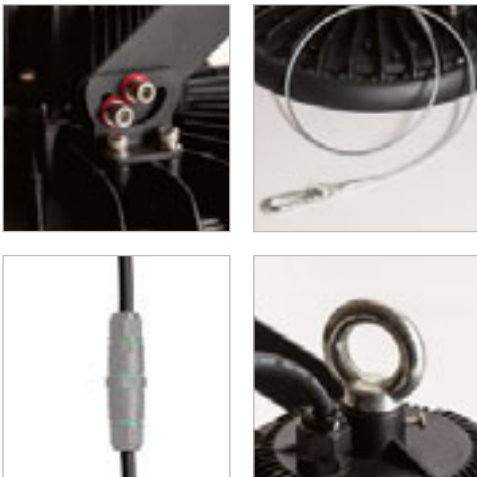

## MEGALOS PRO

Riflettore LED a sospensione in design industriale di potenza alta. Fornito con corda di sicurezza (0,5m), gancio di sospensione e cavo di alimentazione di 0,2m. Si consiglia di utilizzare IP BOX G12984 per collegare il cavo di alimentazione.

### MEGALOS PRO 26 CORPO

230 V LED 100 W  $\angle 90^\circ$  4000 K 16000 lm Ra 80 IP65

G13749 nero

€ 88

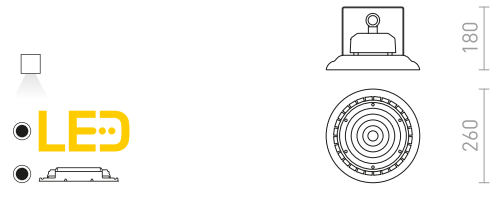

### MEGALOS PRO 30 CORPO

230 V LED 150 W  $\angle 90^\circ$  4000 K 24000 lm Ra 80 IP65

G13750 nero

€ 120

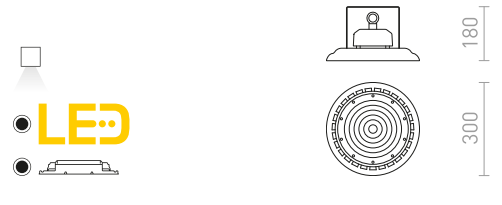

### MEGALOS PRO 35 CORPO

230 V LED 200 W  $\angle 90^\circ$  4000 K 32000 lm Ra 80 IP65

G13751 nero

€ 138







## LAMPADE DA SOFFITTO

|                |         |
|----------------|---------|
| PER BAGNO      | 96-115  |
| DI GESSO       | 116-121 |
| DECORATIVE     | 122-125 |
| DOWNLIGHT      | 126-143 |
| CIRCOLARI      | 144-155 |
| AD ANGOLO      | 156-167 |
| DESIGN TECNICO | 168-173 |
| LONGITUDINALI  | 174-175 |

# DA SOFFITTO PER BAGNO



**GRANDE LED 25**  
96-97



**GRANDE LED 35**  
96-97



**CIRA LED 23**  
98-99

96-115



**CIRA LED 35**  
98-99



**GORRA**  
100-101



**BARRY**  
100-101



**AWE 23**  
100-101



**AWE 33**  
100-101



**ZARA LED 26**  
102-103



**SARA LED 26**  
102-103



**SARA LED 36**  
102-103



**SASSARI**  
102-103



**VENICE 23**  
104-105



**VENICE LED 30**  
104-105



**ARANA R 17**  
104-105



**ARANA R 27**  
104-105



**BOLLY 17**  
106-107



**BOLLY 26**  
106-107



**MERINGUE 11**  
106-107



**MERINGUE 16**  
106-107



**ESICA CYL**  
108-109



**EIGHT**  
108-109



**ESICA SQ**  
108-109



**LOLA 88**  
110-111



**SAMMY**  
110-111



**EILEEN**  
110-111



**KIM**  
110-111



**ORIN R**  
112-113



**MERIDO**  
112-113



**DEZA**  
112-113



**ORIN SQ**  
112-113



**MERANO LED 30**  
114-115



**MERANO LED 35**  
114-115



**SPECTACLE**  
114-115



**BONO**  
114-115

## DA SOFFITTO DI GESSO

116-121



**GINA S 17**  
116-117



**GINA**  
116-117



**GINA III**  
116-117



**COLIN**  
116-117



**JACK SQ**  
118-119



**JACK SQ S 17**  
118-119



**JACK III**  
118-119



**COLES**  
120-121



**COLES SQ**  
120-121



**VOLCA**  
120-121

## DA SOFFITTO DECORATIVE

122-125



**TACO**  
122-123



**OTIS 60**  
122-123



**SOLARIS**  
122-123



**VENICE 23**  
124-125



**VENICE LED 30**  
124-125



**MARA**  
124-125

DA SOFFITTO  
**DOWNLIGHT**

126-143



**BOGARD TWIN**  
126-127



**BELENOS**  
126-127



**BOGARD**  
126-127



**CONDU**  
126-127



**SNAZZY**  
128-129



**PIXIE**  
128-129



**DARIO**  
128-129



**DARIO**  
128-129



**PIXIE**  
128-129



**RIGA 38**  
130-131



**RIGA 18**  
130-131



**CONNOR**  
130-131



**KELLY LED**  
130-131



**VADE R**  
132-133



**TUBA**  
132-133



**CANTO**  
132-133



**MOMA**  
134-135



**MOMA**  
134-135



**MOCCA**  
134-135



**MAYO R**  
134-135



**MEA**  
134-135



**MANTOVA I**  
136-137



**MANTOVA II**  
136-137





**GAYA**  
136-137



**MILANO I**  
136-137



**MILANO II**  
136-137



**ENKI EDG I**  
138-139



**ENKI EDG II**  
138-139



**AGATE I**  
138-139



**AGATE II**  
138-139



**BERIT I**  
140-141



**BERIT II**  
140-141



**MAYO SQ**  
140-141



**JAMES I**  
140-141



**JAMES II**  
140-141



**MARVEL**  
142-143



**MARVEL II**  
142-143



**MARVEL II**  
142-143

## DA SOFFITTO CIRCOLARI



**MEZZO 40**  
144-145



**MEZZO 60**  
144-145



**MEZZO 80**  
144-145

144-155



**LARISA R 12**  
146-147



**LARISA R 22**  
146-147



**LARISA R 30**  
146-147



**LARISA R 40**  
146-147



**LARISA R 12**  
148-149



**LARISA R 22**  
148-149



**LARISA R 30**  
148-149



**HUE R 9**  
150-151



**HUE R 17**  
150-151



**HUE R 22**  
150-151



**HUE R 9**  
152-153



**HUE R 17**  
152-153



**HUE R 22**  
152-153



**MENSA R 80**  
154-155



**ALLEGRO II 43**  
154-155

## DA SOFFITTO AD ANGOLO



**LARISA SQ 17**  
156-157



**LARISA SQ 22**  
156-157



**LARISA SQ 30**  
156-157

156-167



**LARISA SQ 40**  
156-157



**LARISA SQ 17**  
158-159



**LARISA SQ 22**  
158-159



**LARISA SQ 30**  
158-159



**MENSA SQ 40**  
160-161



**MENSA SQ 48**  
160-161



**MENSA SQ 80**  
160-161

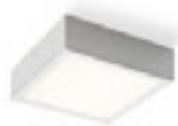

**STRUCTURAL LED 20x20**  
162-163



**STRUCTURAL LED 40x40**  
162-163



**STRUCTURAL LED 55x55**  
162-163



**HUE SQ 9**  
164-165



**HUE SQ 17**  
164-165



**HUE SQ 22**  
164-165



**HUE SQ 9**  
166-167



**HUE SQ 17**  
166-167



**HUE SQ 22**  
166-167

## DA SOFFITTO DESIGN TECNICO

168-173



**SOCORRO R 300**  
168-169



**SLENDER R 12**  
168-169



**SLENDER SQ 12**  
168-169



**SLENDER SQ 22**  
168-169



**SEMPRE SQ 63**  
170-171



**SEMPRE R 55**  
170-171



**MELISA 25**  
170-171



**MELISA 52**  
170-171



**SEMPRE SQ 33**  
172-173



**SEMPRE SQ 43**  
172-173



**SEMPRE SQ 53**  
172-173



**SEMPRE SQ 63**  
172-173

## DA SOFFITTO LONGITUDINALI

174-175



**STRUCTURAL LED 60x15**  
174-175



**TRIDENT PRO 120**  
174-175



**TRIDENT PRO 150**  
174-175



IP44



IP44



## GRANDE

Plafoniera a LED per bagno con vetro piatto opalino in montatura metallica.

### GRANDE LED 25 DA SOFFITTO

230 V LED 12 W 3000 K 900 lm Ra 80 IP44

R13676 vetro opalino/cromo

€ 178

R13677 vetro opalino/nero

€ 158

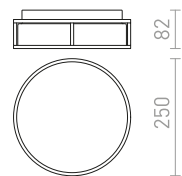

### GRANDE LED 35 DA SOFFITTO

230 V LED 24 W 3000 K 1700 lm Ra 80 IP44

R13678 vetro opalino/cromo

€ 290

R13679 vetro opalino/nero

€ 268

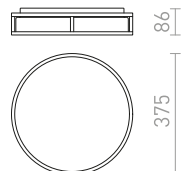







IP44



IP44

## CIRA

Plafoniera a LED con il vetro piatto opalino in montatura metallica. Adatta per ambienti umidi.

### CIRA LED 23 DA SOFFITTO

230 V LED 12 W 3000 K 900 lm Ra 80 IP44

R13680 vetro opalino/nero

€ 120

R13742 vetro opalino/cromo

€ 150

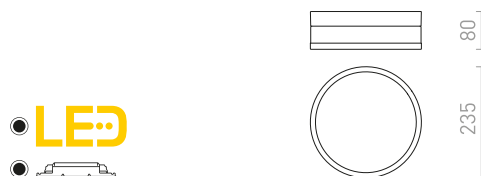

### CIRA LED 35 DA SOFFITTO

230 V LED 24 W 3000 K 1700 lm Ra 80 IP44

R13681 vetro opalino/cromo

€ 258

R13754 vetro opalino/nero

€ 248







IP44

## GORRA

Plafoniera adatta per ambienti umidi. Paralume in vetro opalino con seguenti dimensioni: 24x3 cm (ØxAI).

### GORRA DA SOFFITTO

230 V E14 2x40 W [IP44](#)

**R10500** cromo

€ 88

%

**R12048** nichel opaco

€ 88

%



G11849

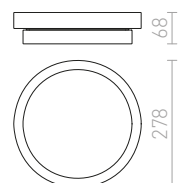



IP44



IP44



IP44



IP44

## BARRY

Plafoniera circolare per bagno con montatura in nichel opaco per lampadine fluorescenti a risparmio energetico.

### BARRY DA SOFFITTO

230 V 2GX13 22 W IP44

R10576 nichel opaco

€ 38

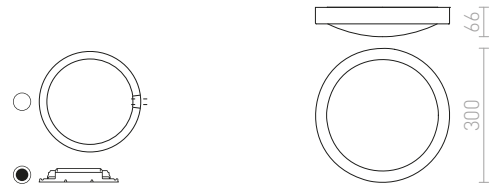

## AWE

Plafoniera con LED integrato e montatura in vetro opalino. Base per soffitto in nichel cromato o opaco. Adatta per ambienti umidi.

### AWE 23 DA SOFFITTO

230 V LED 14 W 3000 K 580 lm Ra 80 IP44

R12196 nichel opaco

€ 129

R12201 cromo

€ 129



### AWE 33 DA SOFFITTO

230 V LED 21 W 3000 K 948 lm Ra 80 IP44

R12197 nichel opaco

€ 215

R12202 cromo

€ 215

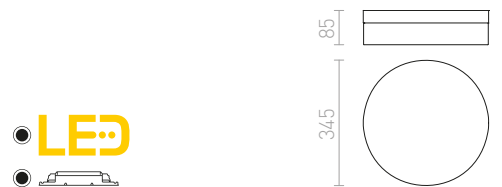



IP44

## ZARA

Plafoniera a LED in vetro opalino su base cromata.  
Adatta per ambienti umidi.

### ZARA LED 26 DA SOFFITTO

230 V LED 12 W 3000 K 900 lm Ra 80 [IP44](#)

R13686 vetro opalino/cromo

€ 129

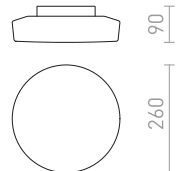

IP65

## SASSARI

Plafoniera LED circolare per bagno.

### SASSARI DA SOFFITTO

230 V LED 24 W 3000 K 1900 lm Ra 80 [IP65](#)

R13642 bianco/polycarbonato/plastica

€ 120

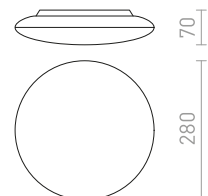





IP44

## SARA

Plafoniera a LED in vetro opalino su base cromata.  
Adatta per ambienti umidi.

### SARA LED 26 DA SOFFITTO

230 V LED 12 W 3000 K 900 lm Ra 80 IP44

R13687 vetro opalino/cromo

€ 129

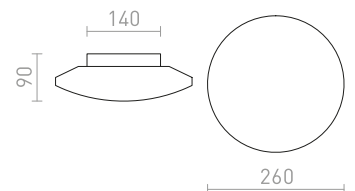

● LED



IP44

### SARA LED 36 DA SOFFITTO

230 V LED 24 W 3000 K 1700 lm Ra 80 IP44

R13688 vetro opalino/cromo

€ 229

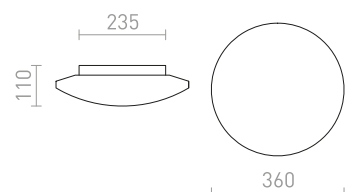

● LED





IP44

## ARANA

Plafoniera cilindrica in vetro opalino su base cromata.  
Adatta per ambienti umidi.

### ARANA R 17 DA SOFFITTO

230 V E27 15 W IP44

R13682 vetro opalino/cromo

€ 120



G13014



160



170



IP44

## ARANA

Plafoniera cilindrica in vetro opalino su base cromata. Adatta per ambienti umidi.

### ARANA R 27 DA SOFFITTO

230 V E27 20 W IP44

R13683 vetro opalino/cromo

€ 178

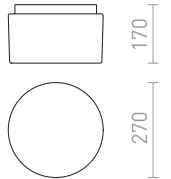

IP44

## VENICE

Plafoniera a LED in combinazione di vetro opalino interno e vetro trasparente esterno su base cromata, compatibile con sorgente luminosa E27. Adatta per ambienti umidi.

### VENICE 23 DA SOFFITTO

230 V E27 20 W IP44

R13684 vetro trasparente/vetro opalino/cromo

€ 198

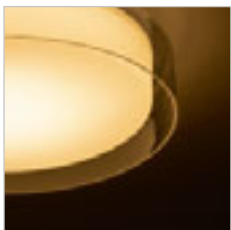
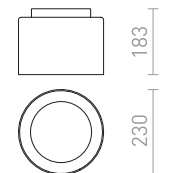

IP44

## VENICE

Plafoniera a LED in combinazione di vetro opalino interno e vetro trasparente esterno su base cromata. Adatta per ambienti umidi.

### VENICE LED 30 DA SOFFITTO

230 V LED 12 W 3000 K 900 lm Ra 80 IP44

R13685 vetro trasparente/vetro opalino/cromo

€ 248

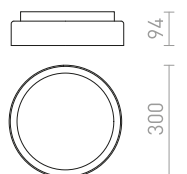





IP44



IP44



IP44

IP44



## BOLLY

Plafoniera in vetro opalino e accessori cromati. Adatta per ambienti umidi.

### BOLLY 17 DA SOFFITTO

230 V E27 15 W IP44

R13693 vetro opalino/cromo

€ 150

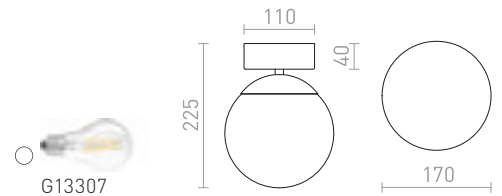

### BOLLY 26 DA SOFFITTO

230 V E27 15 W IP44

R13694 vetro opalino/cromo

€ 178

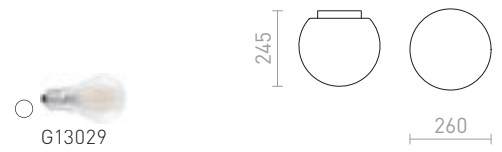

## MERINGUE

Plafoniera ovale in vetro con base cromata. Adatta per ambienti umidi.

### MERINGUE 11 DA SOFFITTO

230 V LED G9 9 W IP44

R13689 vetro opalino/cromo

€ 88 %

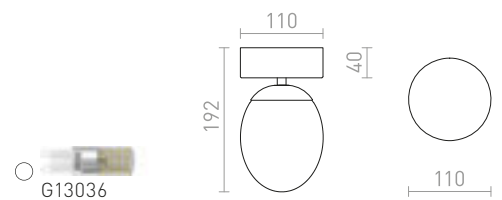

### MERINGUE 16 DA SOFFITTO

230 V E27 15 W IP44

R13690 vetro opalino/cromo

€ 120 %

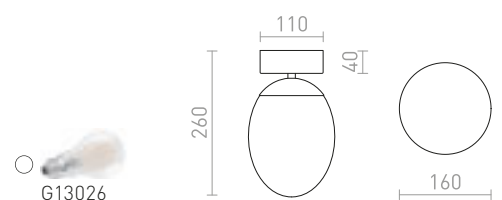





IP44

## ESICA

Plafoniera a LED integrato in vetro opalino. Adatta per ambienti umidi.

### ESICA SQ DA SOFFITTO

230 V LED 6 W 3000 K 435 lm Ra 80 IP44

R12198 cromo

€ 78

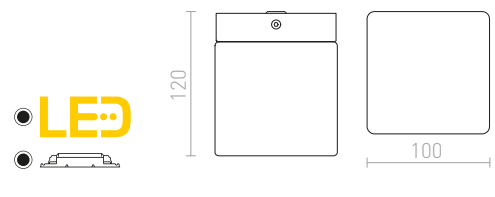

IP44

## ESICA

Plafoniera a LED integrato in vetro opalino. Adatta per ambienti umidi.

### ESICA CYL DA SOFFITTO

230 V LED 6 W 3000 K 369 lm Ra 80 IP44

R12199 cromo

€ 78

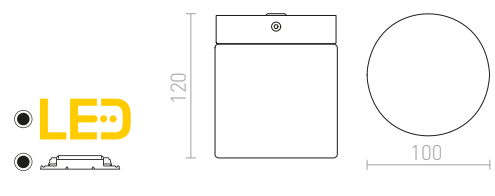

IP44

## EIGHT

Plafoniera con paralume in vetro opalino. Adatta per ambienti umidi.

### EIGHT DA SOFFITTO

230 V E27 28 W IP44

R10492 vetro opalino/cromo

€ 98

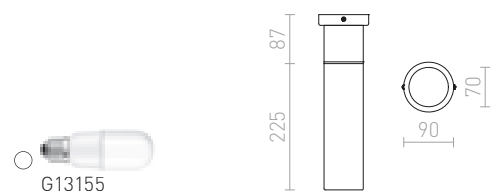





IP65

## EILEEN

Plafoniera cilindrica adatta per uso in bagno, compatibile con lampadine con portalampada GU10.

### EILEEN DA SOFFITTO

230 V GU10 35 W IP65

**R13606** bianco

€ 58

**R13607** nero

€ 58



G11841

117

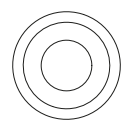
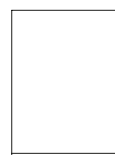

85



IP65

### KIM

Apparecchio da soffitto in forma prisma, adatto per uso in bagno, compatibile con lampadina LED con portalampada GU10.

**KIM DA SOFFITTO**  
230 V GU10 35 W IP65

**R13608** bianco

€ 58

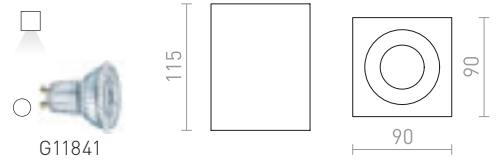

IP54

### LOLA

Faretto cilindrico da soffitto con protezione per ambienti umidi e adatto per il bagno.

**LOLA 88 DA SOFFITTO**  
230 V GU10 15 W IP54

**R13538** bianco

€ 48

**R13539** cromo

€ 48

**R13542** nero

€ 48

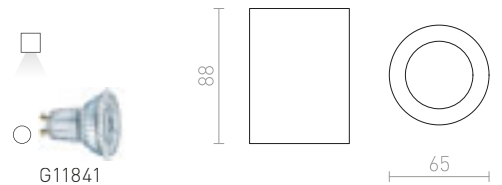

IP54

### SAMMY

Faretto da soffitto per esterno con portalampada GU10. Con copertura inferiore di vetro trasparente.

**SAMMY DA SOFFITTO**  
230 V LED GU10 15 W IP54

**R13450** bianco

€ 58

**R13451** grigio

€ 48

**R13452** grigio antracite

€ 58

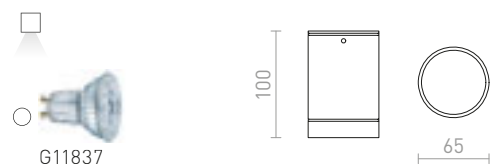



IP54



IP54



## MERIDO

Plafoniera da soffitto o da parete esterna per sorgenti luminose a risparmio energetico GX53.

### MERIDO DA SOFFITTO

230 V GX53 11 W IP54

R10428 bianco

€ 58

R10429 grigio argento

€ 58

R10430 grigio antracite

€ 58

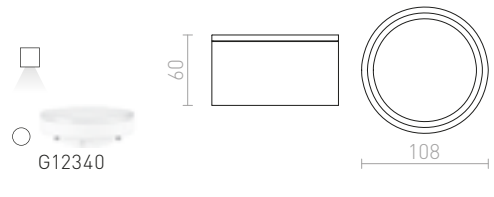

## ORIN

Plafoniera cilindrica a LED da esterno con paralume in vetro satinato.

### ORIN R DA SOFFITTO

230 V LED 10 W 3000 K 650 lm Ra 80 IP54

R13626 bianco/acrilico satinato

€ 78

R13627 grigio antracite/acrilico satinato

€ 78

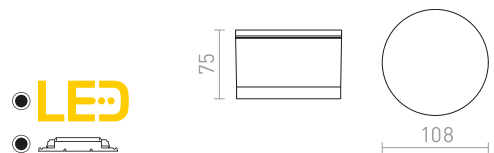





IP54



## ORIN

Plafoniera a LED quadrata da esterno con paralume in vetro satinato.

### ORIN SQ DA SOFFITTO

230 V LED 10 W 3000 K 800 lm Ra 80 IP54

**R13628** bianco/acrilico satinato

€ 78

**R13629** grigio antracite/acrilico satinato

€ 78

LED

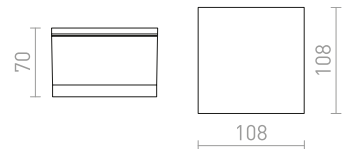

IP54

## DEZA

Plafoniera in alluminio con copertura in vetro satinato.

### DEZA QUADRATO

230 V G9 25 W IP54

**R10166** alluminio/vetro satinato

€ 48



G13036

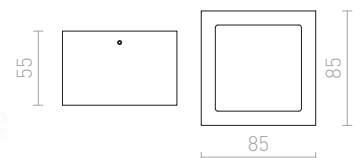

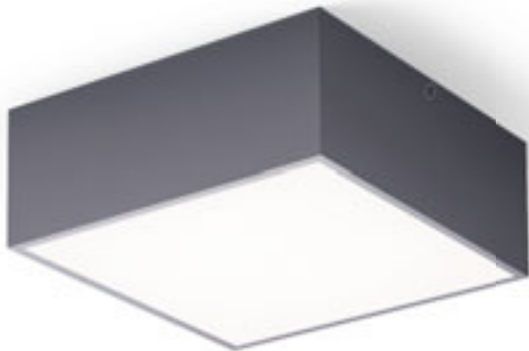

IP65

## BONO

Apparecchio esterno in alluminio pressofuso a LED integrato con diffusore opale. Montaggio da soffitto o da parete.

### BONO PLAFONIERA/APPLIQUE

230 V LED 4 W 3000 K 297 lm Ra 80 IP65

R11967 grigio antracite

€ 150

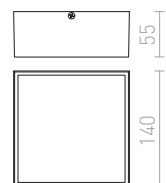
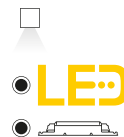



IP54

## SPECTACLE

Apparecchio da esterno a LED in alluminio pressofuso con diffusore opalino. Per montaggio a soffitto o a parete.

**SPECTACLE PLAFONIERA/APPLIQUE**  
230 V LED 5 W 3000 K 350 lm Ra 80 [IP54](#)

**R11968** grigio argento

€ 78

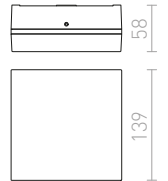
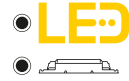

IP44

## MERANO

Plafoniera LED quadrata, adatta per ambienti umidi.

**MERANO LED 30 DA SOFFITTO**  
230 V LED 16 W 3000 K 1300 lm Ra 80 [IP44](#)

**R13697** cromo/acrilato opaco

€ 178

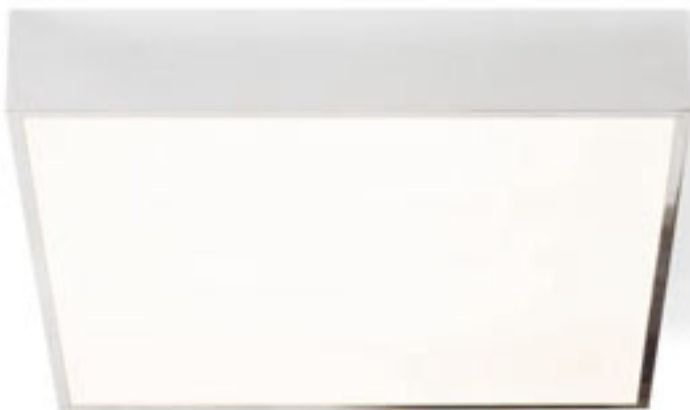
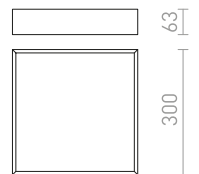

IP44

## MERANO LED 35 DA SOFFITTO

230 V LED 24 W 3000 K 1700 lm Ra 80 [IP44](#)

**R13698** cromo/acrilato opaco

€ 215

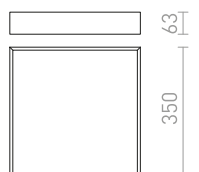



## COLIN

Faretto da soffitto di gesso con portalampada GU10.  
Colorabile con vernice da interni.

**COLIN DA SOFFITTO**

230 V LED GU10 5 W

**R13791** gesso

€ 58

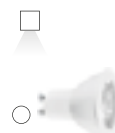

G13466

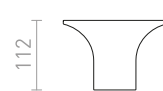

112

68

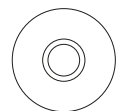

166



## GINA

Apparecchio da soffitto in gesso per sorgente luminosa LED con portalamпада GU10. L'apparecchio può essere colorato con la vernice da interni.

### GINA III DA SOFFITTO

230 V LED GU10 3x5 W

R13789 gesso

€ 120

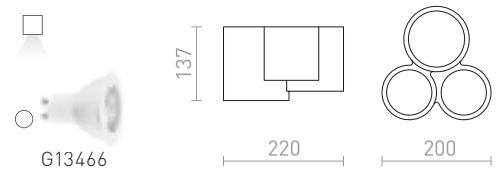

## GINA

Faretto da soffitto di gesso per lampadina con portalamпада GU10. L'apparecchio può essere colorato con la vernice da interni.

### GINA DA SOFFITTO

230 V LED GU10 15 W

R11680 gesso

€ 78

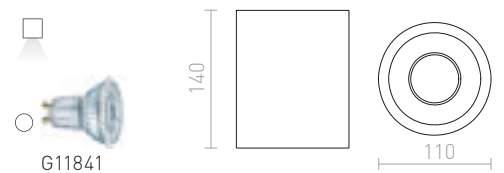

### GINA S 17 DA SOFFITTO

230 V GU10 15 W

R12354 gesso

€ 58

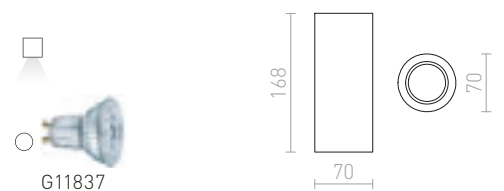







## JACK

Apparecchio da soffitto in gesso per sorgente luminosa LED con portalamпада GU10. L'apparecchio può essere colorato con la vernice da interni.

### JACK III DA SOFFITTO

230 V LED GU10 3x5 W

R13790 gesso

€ 150

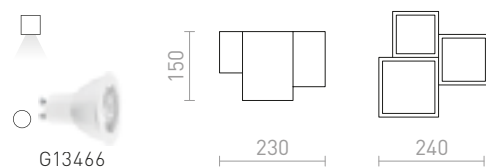

## JACK

Lampada da soffitto quadrata in gesso con portalamпада GU10. La superficie può essere colorata con vernici per interni.

### JACK SQ DA SOFFITTO

230 V LED GU10 15 W

R11957 gesso

€ 78

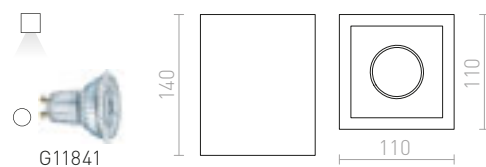

### JACK SQ S 17 DA SOFFITTO

230 V GU10 15 W

R12751 gesso

€ 32

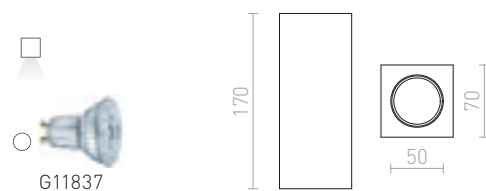



## VOLCA

Apparecchio soffitto di calcestruzzo, per sorgenti luminose a LED con portalampada GU10.

### VOLCA DA SOFFITTO

230 V LED GU10 5 W

R13795 calcestruzzo/granito scuro decor

€ 48

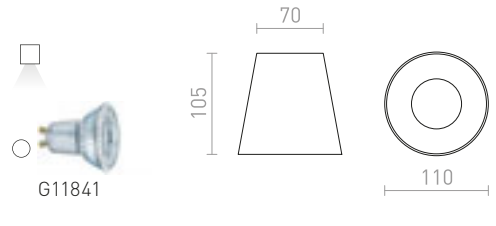

## COLES

Plafoniera con sorgente luminosa inclinabile.

Apparecchio può essere colorato con vernice da interni.

### COLES SQ DA SOFFITTO

230 V LED GU10 15 W

R13438 gesso

€ 58

%

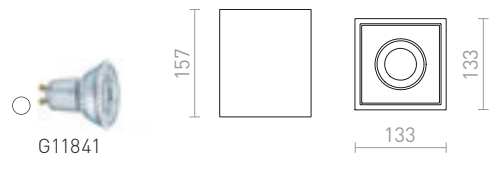

## COLES

Plafoniera con sorgente luminosa inclinabile.

Apparecchio può essere colorato con vernice da interni.

### COLES DA SOFFITTO INCLINABILE

230 V GU10 15 W

R10454 gesso

€ 120

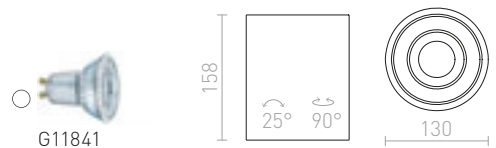







## SOLARIS

Lampada da parete in vetro con base laccata nera.  
Adatta a sorgenti luminose a LED con filettatura E14.

### SOLARIS APPLIQUE/PLAFONIERA

230 V LED E14 7 W

**R13994** vetro trasparente/nero

€ 78

NEW

**R13995** vetro smerigliato/nero

€ 78

NEW

**R13996** vetro fumé/nero

€ 78

NEW

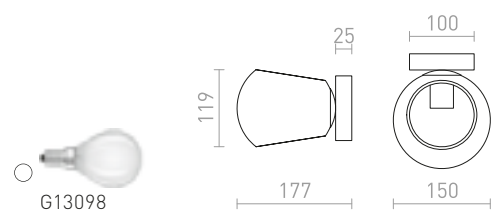





## TACO

Faretto cilindrico da soffitto con paralume in tessuto e portalampada E27. Adatto per sorgenti luminose a risparmio energetico.

### TACO DA SOFFITTO

230 V E27 15 W

R12471 nero/cromo

€ 48 %

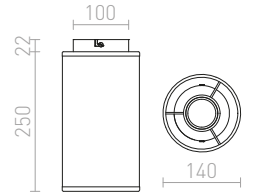

## OTIS

Plafoniera circolare con doppio paralume in tessuto per sorgenti luminose con portalampada E27. Il paralume interno sempre in versione bianca.

### OTIS 60 DA SOFFITTO

230 V E27 4x28 W

R13807 bianco/bianco

€ 420

R13808 nero trasparente/bianco

€ 420

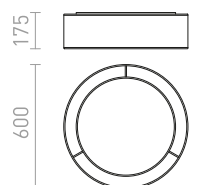



## MARA

Plafoniera con LED integrato, base cromata e diffusore sottilmente convesso.

### MARA DA SOFFITTO

230 V LED 24 W 3000 K 1760 lm Ra 80

R12894 acrilico/cromo

€ 88

%

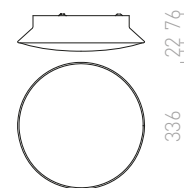

IP44

## VENICE

Plafoniera a LED in combinazione di vetro opalino interno e vetro trasparente esterno su base cromata, compatibile con sorgente luminosa E27. Adatta per ambienti umidi.

### VENICE 23 DA SOFFITTO

230 V E27 20 W IP44

R13684 vetro trasparente/vetro opalino/cromo

€ 198

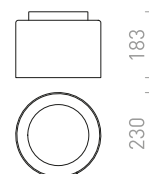

IP44

## VENICE

Plafoniera a LED in combinazione di vetro opalino interno e vetro trasparente esterno su base cromata. Adatta per ambienti umidi.

### VENICE LED 30 DA SOFFITTO

230 V LED 12 W 3000 K 900 lm Ra 80 IP44

R13685 vetro trasparente/vetro opalino/cromo

€ 248

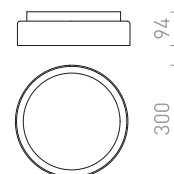





## BOGARD

Plafoniera con due faretti a LED, uno fisso e l'altro orientabile.

### BOGARD TWIN DA SOFFITTO

230 V LED 2x5 W  $\angle 40^\circ$  3000 K 700 lm Ra 80

R12499 nero opaco

€ 120

R12500 nichel opaco

€ 88

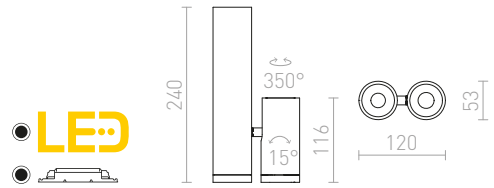

## BOGARD

Faretto a tubo da soffitto orientabile e con LED integrato.

### BOGARD DA SOFFITTO

230 V LED 5 W  $\angle 40^\circ$  3000 K 414 lm Ra 80

R12497 nero opaco

€ 68

R12498 nichel opaco

€ 78

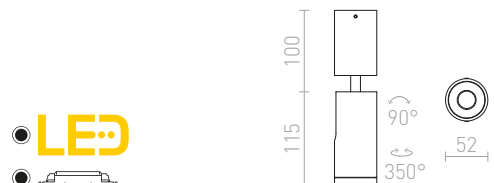

## BELENOS

Faretto cilindrico semplice su base rotonda, per sorgenti luminose con portalampada GU10. Le molle fissate alla base consentono l'uso di sorgenti luminose di varie lunghezze.

### BELENOS DA SOFFITTO

230 V LED GU10 9 W

R13363 bianco

€ 48

R13364 nero

€ 48

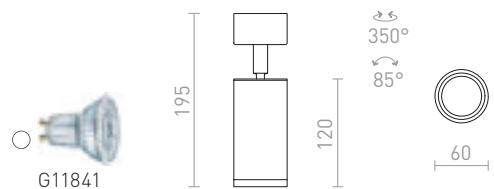





## CONDU

Faretto da soffitto cilindrico massiccio con LED integrato e funzione inclinabile.

### CONDU DA SOFFITTO

230 V LED 20 W  $\angle 24^\circ$  3000 K 1600 lm Ra 80

R12839 bianco

€ 120

R12840 nero

€ 120

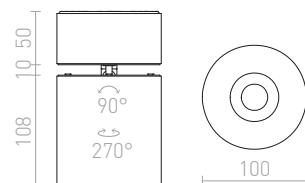



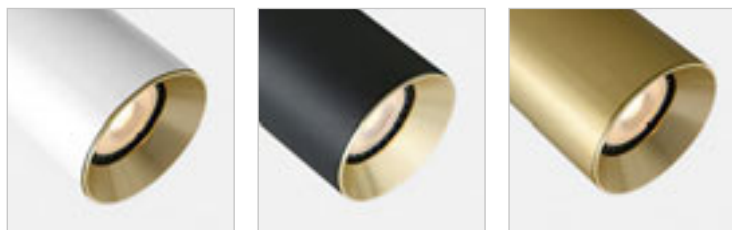

## PIXIE

Plafoniera in alluminio per sorgenti LED a risparmio energetico con portalampada GX53.

### PIXIE DA SOFFITTO

230 V LED GX53 7 W

R11770 bianco/cromo

€ 138

R11771 nero/cromo

€ 138

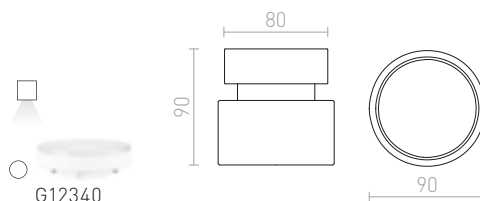

## DARIO

Faretto cilindrico inclinabile a soffitto per lampadina LED con attacco GU10 comprensivo di anello decorativo in metallo in colore ottone spazzolato. Se si vuole cambiare colore è possibile acquistare un anello in bianco o nero.

### DARIO DA SOFFITTO

230 V GU10 9 W

R13867 bianco/ottone spazzolato

€ 68

NEW

R13868 nero/ottone spazzolato

€ 68

NEW

R13869 ottone spazzolato

€ 78

NEW

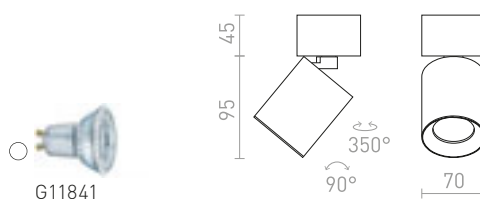

## DARIO

Anello decorativo in alluminio per la possibilità di cambiare il colore delle lampade DARIO.

### DARIO ANELLO DECORATIVO

R13876 bianco

€ 8.50

NEW

R13877 nero

€ 8.50

NEW

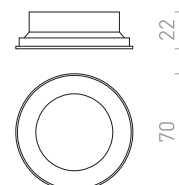



## PIXIE

Apparecchio inclinabile su base, per lampadine LED a risparmio energetico con portalampada GX53.

### PIXIE INCLINABILE

230 V LED GX53 7 W

R11772 bianco/cromo

€ 138

R11773 nero/cromo

€ 138

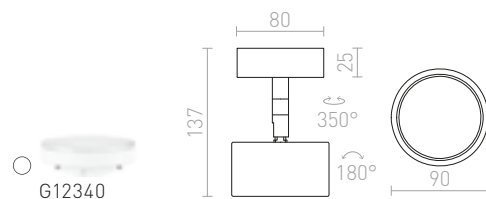

## SNAZZY

Faretto da soffitto cilindrico con funzione inclinabile, per sorgenti luminose GU10.

### SNAZZY

230 V GU10 35 W

R12670 bianco

€ 78

R13552 nero

€ 78

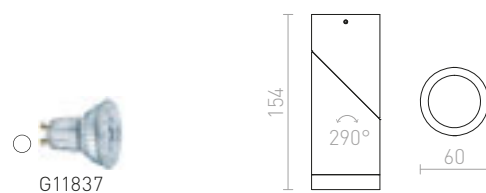



## KELLY LED

Plafoniera dimmerabile non orientabile, con sorgente luminosa a LED integrata. Dimmerazione TRIAC.

### KELLY LED DIMM DA SOFFITTO

230 V LED 15 W  $\angle 45^\circ$  3000 K 750 lm Ra 85

R12633 bianco

€ 120

R12634 nero

€ 120

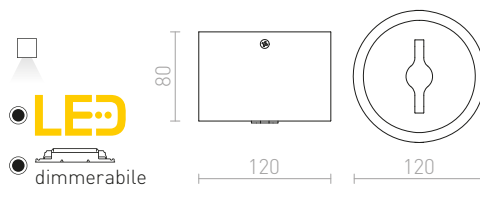

## RIGA

Apparecchio da soffitto con LED integrato, disponibile in quattro colori.

### RIGA 18 DA SOFFITTO

230 V LED 4 W  $\angle 38^\circ$  3000 K 285 lm Ra 80

R12448 cromo

€ 68

%

R12449 rame

€ 68

%

R12450 bianco

€ 78

R12451 nero

€ 78



### RIGA 38 DA SOFFITTO

230 V LED 6 W  $\angle 38^\circ$  3000 K 570 lm Ra 80

R12452 cromo

€ 68

%

R12453 rame

€ 68

%

R12454 bianco

€ 78

R12455 nero

€ 78

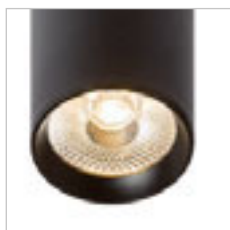



## CONNOR

Faretto da soffitto cilindrico non inclinabile con portalampada GU10 per lampadina a riflettore.

### CONNOR DA SOFFITTO

230 V LED GU10 10 W

R13496 bianco/nero

€ 48

R13501 nero/oro

€ 48



G11841

96

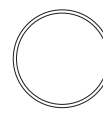
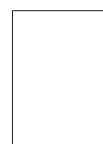

69



## CANTO

Faretto cilindrico adatto per essere completato da anello decorativo Canto.

### CANTO DA SOFFITTO SENZA ANELLO DECORATIVO

230 V LED GU10 8 W

R13471 bianco

€ 48

R13472 nero

€ 48



G11841

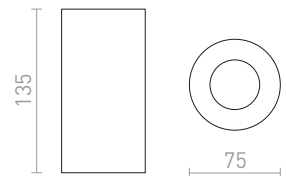

## CANTO

Anello decorativo in quattro opzioni di colore per faretto Canto.

### CANTO ANELLO DECORATIVO

R13473 bianco

€ 6

R13474 oro

€ 6

R13475 lamina di rame

€ 6

R13476 nero

€ 6

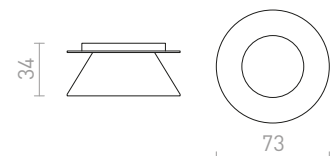





## TUBA

Faretto da soffitto cilindrico per sorgenti luminose con portalampada GU10, non inclinabile.

### TUBA DA SOFFITTO

230 V GU10 35 W

**R12745** bianco opaco/oro

**€ 48**

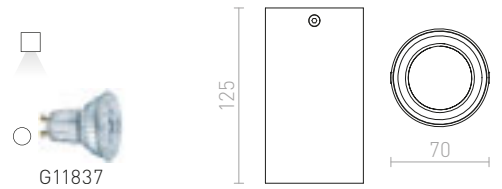

## VADE

Plafoniera per sorgente luminosa con portalampada GU10 non orientabile.

### VADE R

230 V GU10 35 W

**R12669** bianco/nero

**€ 48**

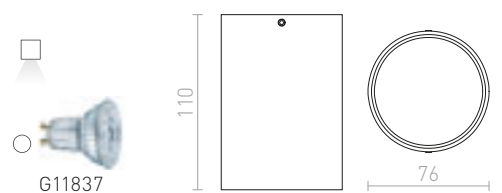



## MAYO

Faretto cilindrico da soffitto con LED integrato reclinabile. Potenza 9W. Driver incluso.

### MAYO R DA SOFFITTO RECLINABILE

230 V LED 9 W  $\angle 36^\circ$  2700 K 400 lm Ra 80

R10374 alluminio spazzolato

€ 78 %

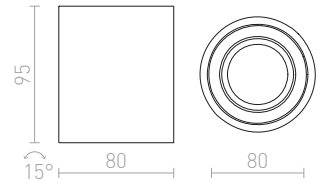

## MEA

Apparecchio da soffitto cilindrico per sorgenti luminose E27 a risparmio energetico con copertura in vetro satinato.

### MEA DA SOFFITTO CILINDRICO

230 V E27 18 W

R10212 alluminio spazzolato

€ 58 %

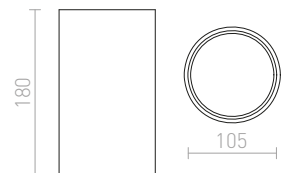

## MOCCA

Faretto cilindrico in alluminio lucidato, con funzione inclinabile.

### MOCCA DA SOFFITTO

230 V GU10 50 W

R10124 alluminio

€ 78 →

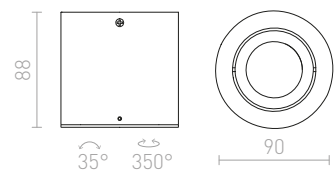



## MOMA

Faretto cilindrico con funzione inclinabile, per sorgente luminosa con portalampada GU10.

### MOMA INCLINABILE

230 V GU10 35 W

**R12044** bianco

€ 58

**R12517** nero

€ 58

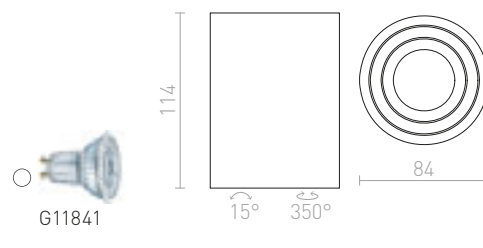

## MOMA

Faretto cilindrico per sorgente luminosa alogena non orientabile con altezza massima di 56 mm.

### MOMA DA SOFFITTO

230 V GU10 35 W

**R12043** bianco

€ 35

**R12047** nichel opaco

€ 26

**R12516** nero

€ 35

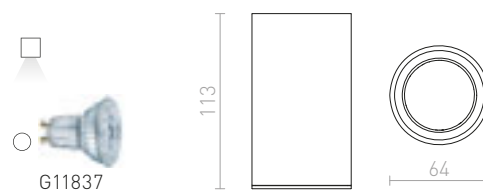



## MANTOVA

Lampada da soffitto con portalampada GU10 non inclinabile.

### MANTOVA I DA SOFFITTO

230 V GU10 35 W

**R12729** bianco opaco € 38

**R12730** alluminio spazzolato € 38

**R12731** nero opaco € 38

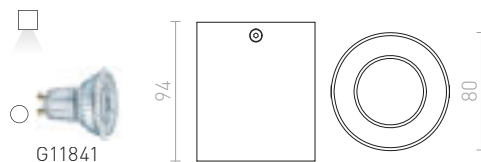

### MANTOVA II DA SOFFITTO

230 V GU10 2x35 W

**R12732** bianco opaco € 68

**R12733** alluminio spazzolato € 48

**R12734** nero opaco € 68



## GAYA

Faretto da soffitto cilindrico per sorgente luminosa non orientabile con portalampada GU10.

### GAYA

230 V GU10 35 W

**R12667** bianco € 35

**R12668** nero € 35

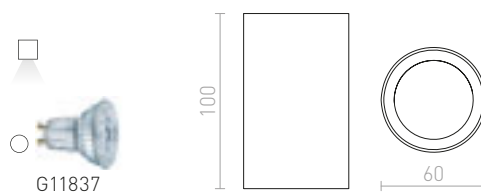



## MILANO

Faretto da soffitto con funzione inclinabile per sorgenti luminose GU10.

### MILANO I DA SOFFITTO

230 V GU10 35 W

**R12681** nero opaco/alluminio spazzolato

€ 48

**R12682** alluminio spazzolato

€ 48

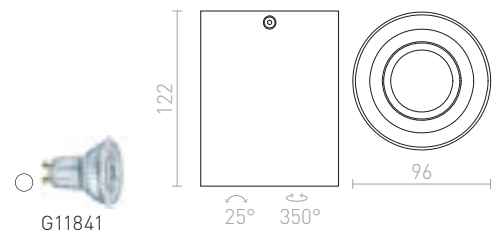

### MILANO II DA SOFFITTO

230 V GU10 2x35 W

**R12684** alluminio spazzolato

€ 68

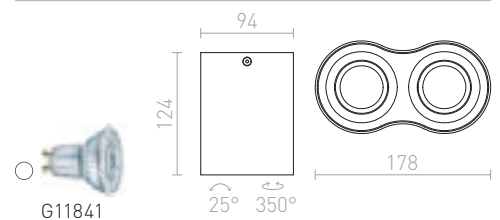







## AGATE

Plafoniera quadrata con portalampada GU10 senza possibilità di inclinazione.

### AGATE I DA SOFFITTO

230 V GU10 35 W

**R12735** bianco opaco

€ 35

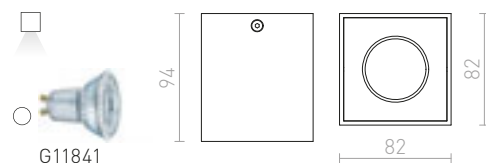

### AGATE II DA SOFFITTO

230 V GU10 2x35 W

**R12737** bianco opaco

€ 58

**R12738** alluminio spazzolato

€ 35

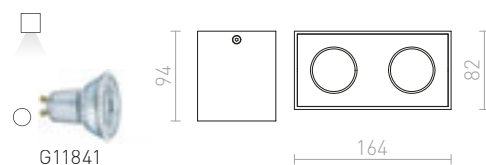

## ENKI

Plafoniera con funzione inclinabile per lampadine a riflettore con portalampada GU10.

### ENKI EDG I

230 V GU10 35 W

**R12672** bianco

€ 58

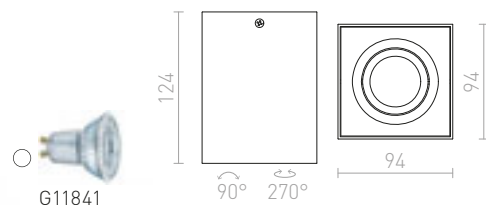

### ENKI EDG II

230 V GU10 2x35 W

**R12673** bianco

€ 98

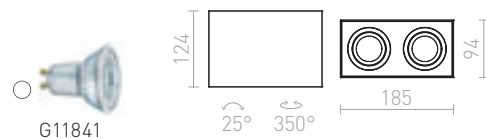



## BERIT

Plafoniera rettangolare in alluminio per sorgenti luminose GU10 inclinabile lungo due assi.

### BERIT I DA SOFFITTO

230 V GU10 50 W

R10119 alluminio

€ 58 %

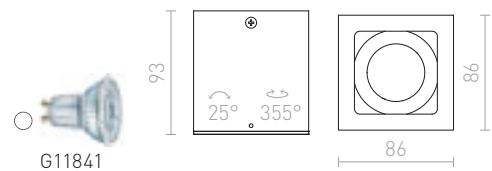

### BERIT II DA SOFFITTO

230 V GU10 2x50 W

R10120 alluminio

€ 68 %





## JAMES

Faretto da soffitto laccato, con LED incorporato che può essere inclinato su due assi. Dimmerazione TRIAC.

### JAMES I DIMM DA SOFFITTO

230 V LED 15 W  $\angle 24^\circ$  3000 K 800 lm Ra 80

R13361 bianco opaco

€ 88

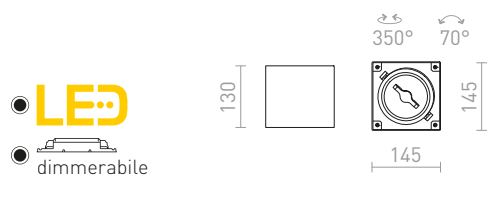

### JAMES II DIMM DA SOFFITTO

230 V LED 2x15 W  $\angle 24^\circ$  3000 K 1600 lm Ra 80

R13362 bianco opaco

€ 158

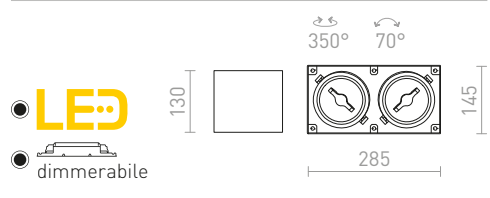

## MAYO

Faretto cubico da parete/da soffitto con LED integrato. Potenza 9W. Driver incluso.

### MAYO SQ DA SOFFITTO RECLINABILE

230 V/700 mA LED 9 W  $\angle 36^\circ$  2700 K 400 lm Ra 80

R10326 bianco

€ 120

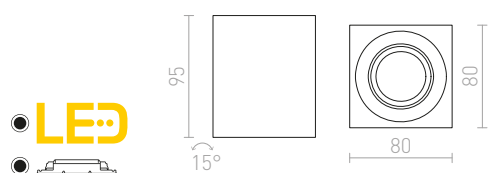









## MARVEL

Lampada quadrata in alluminio, per due lampadine dicroiche con portalampada GU10 che possono essere inclinate individualmente su una base centrale.

### MARVEL II INCLINABILE

230 V GU10 2x50 W

R10171 alluminio

€ 48 %



G11841

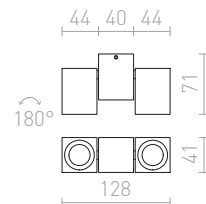

## MARVEL

Lampada quadrata in alluminio, per lampadine dicroiche con portalampada GU10. Senza possibilità di inclinare luci.

### MARVEL DA SOFFITTO

230 V GU10 50 W

R10122 alluminio

€ 14.50 %



G11841

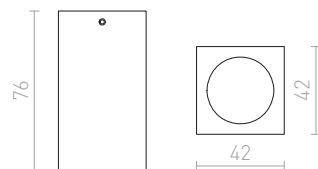

### MARVEL II DA SOFFITTO

230 V GU10 2x50 W

R10123 alluminio

€ 15.50 %



G11841

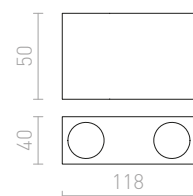



## MEZZO

Plafoniera a diodo LED con cornice in alluminio laccato. Il diffusore della luce è incluso nel policarbonato bianco latte. Possibilità di versione a sospensione con set da sospensione. Dimmerazione TRIAC.

### MEZZO 40 DIMM DA SOFFITTO

230 V LED 30 W 3000 K 1800 lm Ra 80

R13328 bianco

€ 258

R13329 nero

€ 258



LED

dimmerabile

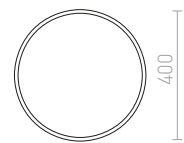

### MEZZO 60 DIMM DA SOFFITTO

230 V LED 60 W 3000 K 3700 lm Ra 80

R13332 bianco

€ 480

R13333 nero

€ 480



LED

dimmerabile

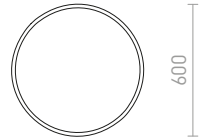
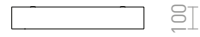

### MEZZO 80 DIMM DA SOFFITTO

230 V LED 100 W 3000 K 6400 lm Ra 80

R13334 bianco

€ 850



LED

dimmerabile

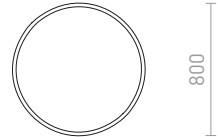
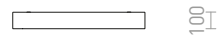









## LARISA

Plafoniera con LED integrato e montatura minimalista.

### LARISA R 12 DA SOFFITTO

230 V LED 10 W 3000 K 800 lm Ra 80

|        |             |      |
|--------|-------------|------|
| R12842 | bianco      | € 58 |
| R12843 | oro perlato | € 58 |
| R13479 | nero        | € 58 |



LED

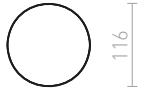

### LARISA R 22 DA SOFFITTO

230 V LED 20 W 3000 K 1600 lm Ra 80

|        |             |      |
|--------|-------------|------|
| R13481 | bianco      | € 98 |
| R13482 | oro perlato | € 98 |
| R13483 | nero        | € 98 |



LED

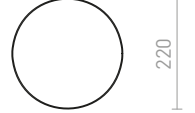

### LARISA R 30 DA SOFFITTO

230 V LED 30 W 3000 K 2400 lm Ra 80

|        |             |       |
|--------|-------------|-------|
| R12844 | bianco      | € 138 |
| R12845 | oro perlato | € 150 |
| R13480 | nero        | € 138 |



LED

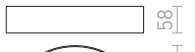

### LARISA R 40 DA SOFFITTO

230 V LED 50 W 3000 K 4000 lm Ra 80

|        |             |       |
|--------|-------------|-------|
| R13484 | bianco      | € 215 |
| R13485 | oro perlato | € 215 |
| R13486 | nero        | € 215 |



LED

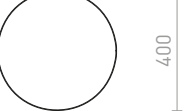
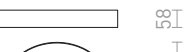





## LARISA

Plafoniera con LED integrato e montatura minimalista.  
Dimmerazione TRIAC.

### LARISA R 12 DIMM DA SOFFITTO

230 V LED 10 W 3000 K 800 lm Ra 80

**R13157** bianco € 88

**R13164** oro perlato € 88

**R13551** nero € 88



LED

dimmerabile

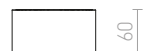

### LARISA R 22 DIMM DA SOFFITTO

230 V LED 20 W 3000 K 1600 lm Ra 80

**R13743** oro perlato € 138

**R13843** nero € 129

**R13844** bianco € 129



LED

dimmerabile

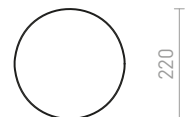

### LARISA R 30 DIMM DA SOFFITTO

230 V LED 30 W 3000 K 2400 lm Ra 80

**R13177** bianco € 178

**R13178** oro perlato € 178

**R13570** nero € 178



LED

dimmerabile

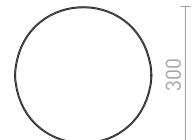
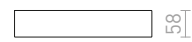







## HUE

Plafoniera/applique molto sottile con diodi LED ad alta luminosità. Montatura in finiture: cromo, cromo nero, nichel opaco, laccata bianco o nell'imitazione del legno.

### HUE R 9 DA SOFFITTO

230 V LED 6 W 3000 K 540 lm Ra 80

|                                    |                |   |
|------------------------------------|----------------|---|
| <b>R12790</b> bianco               | <b>€ 26</b>    | ➔ |
| <b>R12791</b> nero cromato         | <b>€ 19.50</b> | % |
| <b>R12792</b> cromo                | <b>€ 24</b>    | % |
| <b>R12794</b> imitazione di faggio | <b>€ 28</b>    | ➔ |

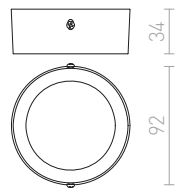

### HUE R 17 DA SOFFITTO

230 V LED 18 W 3000 K 1620 lm Ra 80

|                                     |             |   |
|-------------------------------------|-------------|---|
| <b>R12795</b> bianco                | <b>€ 58</b> | ➔ |
| <b>R12798</b> nichel opaco          | <b>€ 48</b> | % |
| <b>R12799</b> imitazione di faggio  | <b>€ 48</b> | % |
| <b>R13404</b> imitazione noce scuro | <b>€ 48</b> | % |

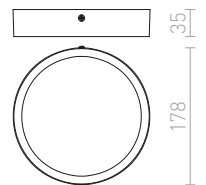

### HUE R 22 DA SOFFITTO

230 V LED 24 W 3000 K 2160 lm Ra 80

|                                     |             |   |
|-------------------------------------|-------------|---|
| <b>R12800</b> bianco                | <b>€ 68</b> | ➔ |
| <b>R12804</b> imitazione di faggio  | <b>€ 68</b> | % |
| <b>R13405</b> imitazione noce scuro | <b>€ 68</b> | % |

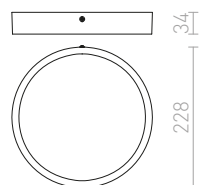





## HUE

Plafoniera/applique molto sottile con diodo LED ad alta luminosità e dimmerabile. Montatura in finiture: cromo, cromo nero, nichel opaco, laccata bianco o nell'imitazione del legno. Dimmerazione TRIAC.

### HUE R 9 DIMM DA SOFFITTO

230 V LED 6 W 3000 K 540 lm Ra 80

|                                    |      |
|------------------------------------|------|
| <b>R13137</b> bianco               | € 58 |
| <b>R13138</b> nero cromato         | € 58 |
| <b>R13139</b> cromo                | € 58 |
| <b>R13141</b> imitazione di faggio | € 58 |

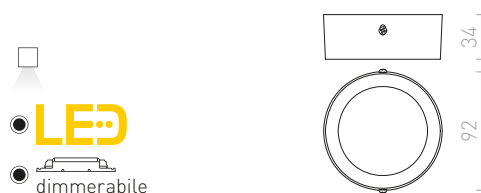

### HUE R 17 DIMM DA SOFFITTO

230 V LED 18 W 3000 K 1620 lm Ra 80

|                                     |       |
|-------------------------------------|-------|
| <b>R13073</b> bianco                | € 120 |
| <b>R13076</b> nichel opaco          | € 120 |
| <b>R13077</b> imitazione di faggio  | € 120 |
| <b>R13444</b> Imitazione noce scuro | € 120 |



### HUE R 22 DIMM DA SOFFITTO

230 V LED 24 W 3000 K 2160 lm Ra 80

|                                     |       |
|-------------------------------------|-------|
| <b>R13078</b> bianco                | € 129 |
| <b>R13082</b> imitazione di faggio  | € 138 |
| <b>R13445</b> Imitazione noce scuro | € 129 |











## MENSA

Plafoniera da soffitto LED con montatura in alluminio spazzolato. Fornita con diffusore in acrilico bianco latte.

### MENSA R 80 DA SOFFITTO

230 V LED 80 W 3000 K 6800 lm Ra 80

R12119 alluminio spazzolato

€ 560 %

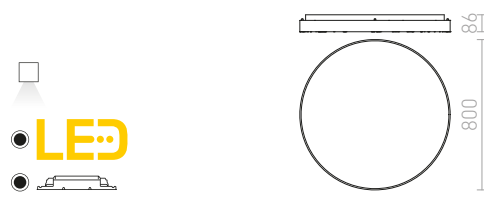

## ALLEGRO

Plafoniera con sorgente luminosa a diodo LED e con montatura in alluminio laccato. Il diffusore incassato in acrilico bianco latte è incluso. Dimmerazione TRIAC.

### ALLEGRO II 43 DIMM DA SOFFITTO

230 V LED 30 W 3000 K 1950 lm Ra 80

R13730 bianco

€ 360

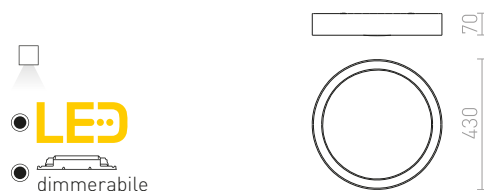



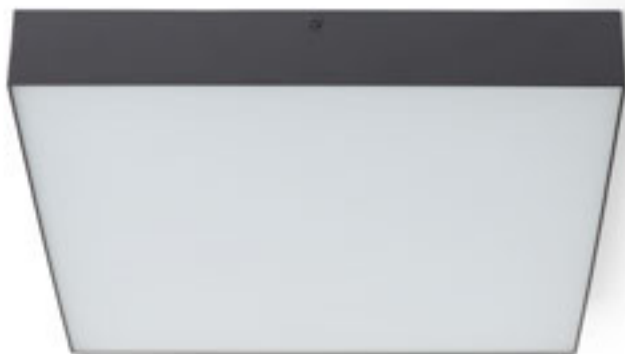
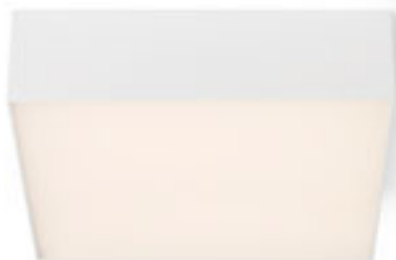

## LARISA

Plafoniera con LED integrato e montatura minimalista.

### LARISA SQ 17 DA SOFFITTO

230 V LED 15 W 3000 K 1200 lm Ra 80

R12848 bianco

€ 78

R12849 nero

€ 78

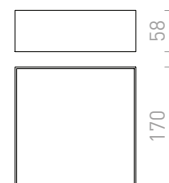
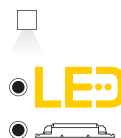

### LARISA SQ 22 DA SOFFITTO

230 V LED 20 W 3000 K 1600 lm Ra 80

R13487 bianco

€ 88

R13488 nero

€ 88

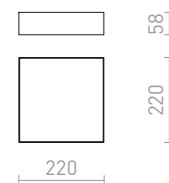
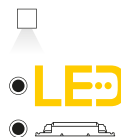

### LARISA SQ 30 DA SOFFITTO

230 V LED 30 W 3000 K 2400 lm Ra 80

R12850 bianco

€ 138

R12851 nero

€ 138

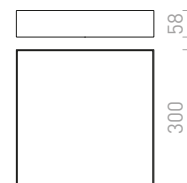
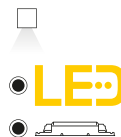

### LARISA SQ 40 DA SOFFITTO

230 V LED 50 W 3000 K 4000 lm Ra 80

R13489 bianco

€ 188

R13490 nero

€ 188

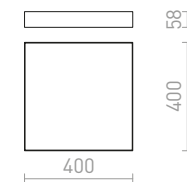
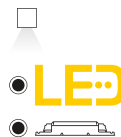









## LARISA

Plafoniera con LED integrato e montatura minimalista. Dimmerazione TRIAC.

**LARISA SQ 17 DIMM DA SOFFITTO**  
230 V LED 15 W 3000 K 1200 lm Ra 80

**R13158** bianco € 98  
**R13938** nero € 98

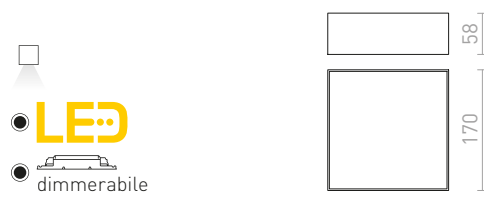

**LARISA SQ 22 DIMM DA SOFFITTO**  
230 V LED 20 W 3000 K 1600 lm Ra 80

**R13851** bianco € 120  
**R13939** nero € 120

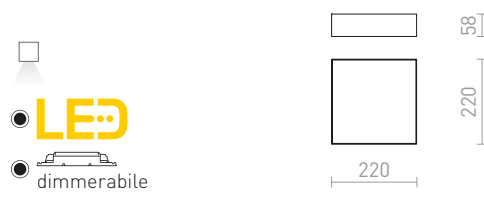

**LARISA SQ 30 DIMM DA SOFFITTO**  
230 V LED 30 W 3000 K 2400 lm Ra 80

**R13267** bianco € 178  
**R13268** nero € 178

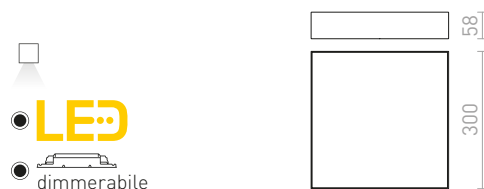

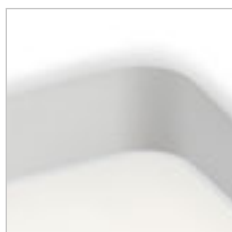
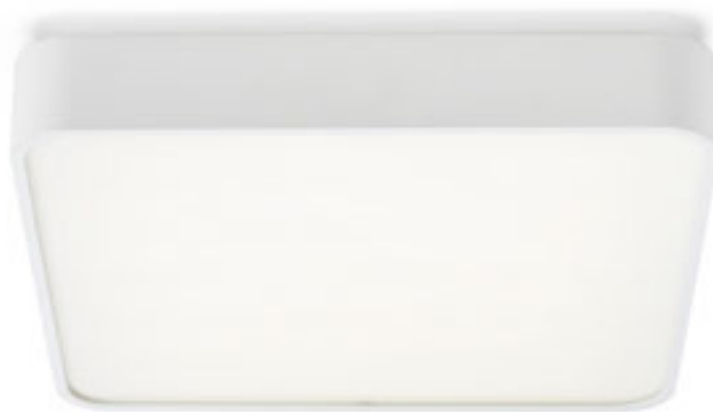

## MESA

Plafoniera da soffitto con LED integrato e montatura in alluminio laccato o spazzolato. Fornita con diffusore in acrilico bianco latte.

### MESA SQ 40 DA SOFFITTO

230 V LED 38 W 3000 K 2470 lm Ra 80

R10582 bianco

€ 198 %

R11290 alluminio spazzolato

€ 220 %

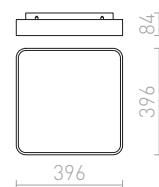
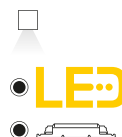

### MESA SQ 48 DA SOFFITTO

230 V LED 56 W 3000 K 3640 lm Ra 80

R11299 alluminio spazzolato

€ 178 %

R12120 bianco

€ 268 →

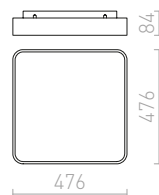
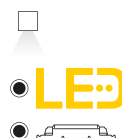

### MESA SQ 80 DA SOFFITTO

230 V LED 138 W 3000 K 8700 lm Ra 80

R12121 alluminio spazzolato

€ 580 %

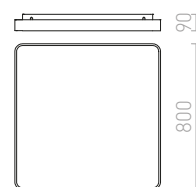
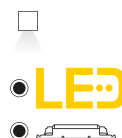





## STRUCTURAL

Plafoniera/applique con LED integrato e montatura in alluminio laccato. Driver incluso.

**STRUCTURAL LED 40x40 PLAFONIERA/APPLIQUE**  
230 V LED 40 W 3000 K 2918 lm Ra 80

**R12063** bianco

**€ 215**

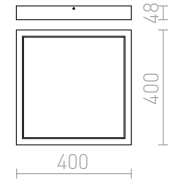

## STRUCTURAL

Plafoniera a LED dal profilo di alluminio, design elegante in alluminio naturale o laccato in bianco, con il diffusore PMMA opalino, illuminazione diretta verso il basso.

**STRUCTURAL LED 20x20 PLAFONIERA/APPLIQUE**  
230 V LED 12 W 3000 K 900 lm Ra 80

**R13707** bianco

**€ 150** →

**R13708** alluminio spazzolato

**€ 150** →

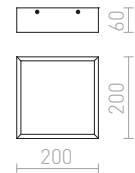

**STRUCTURAL LED 55x55 PLAFONIERA/APPLIQUE**  
230 V LED 48 W 3000 K 3600 lm Ra 80

**R13711** bianco

**€ 229** %

**R13712** alluminio spazzolato

**€ 229** %

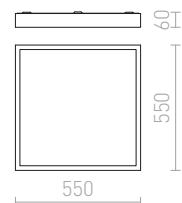







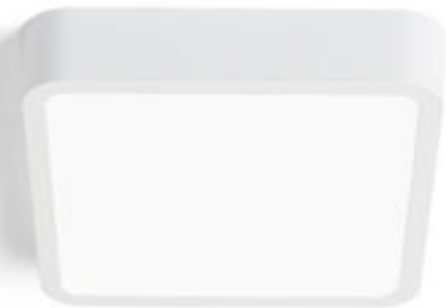

## HUE

Plafoniera/applique molto sottile con diodi LED ad alta luminosità. Montatura in finiture: cromo, cromo nero, nichel opaco, laccata bianco o nell'imitazione del legno.

### HUE SQ 9 DA SOFFITTO

230 V LED 6 W 3000 K 540 lm Ra 80

|                            |      |   |
|----------------------------|------|---|
| <b>R12805</b> bianco       | € 24 | ➔ |
| <b>R12806</b> nero cromato | € 18 | % |
| <b>R12807</b> cromo        | € 17 | % |
| <b>R12808</b> nichel opaco | € 15 | % |

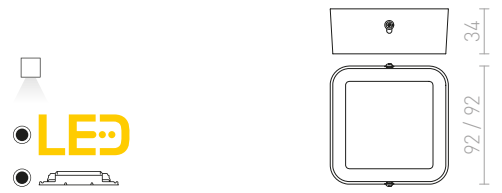

### HUE SQ 17 DA SOFFITTO

230 V LED 18 W 3000 K 1620 lm Ra 80

|                                    |      |   |
|------------------------------------|------|---|
| <b>R12810</b> bianco               | € 58 | ➔ |
| <b>R12811</b> nero cromato         | € 32 | % |
| <b>R12812</b> cromo                | € 35 | % |
| <b>R12813</b> nichel opaco         | € 32 | % |
| <b>R12814</b> imitazione di faggio | € 58 | ➔ |

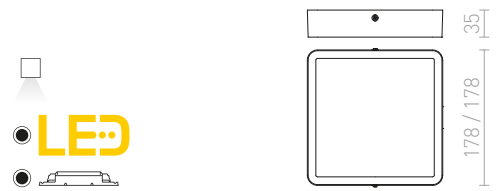

### HUE SQ 22 DA SOFFITTO

230 V LED 24 W 3000 K 2160 lm Ra 80

|                            |      |   |
|----------------------------|------|---|
| <b>R12815</b> bianco       | € 78 | ➔ |
| <b>R12816</b> nero cromato | € 48 | % |
| <b>R12817</b> cromo        | € 48 | % |
| <b>R12818</b> nichel opaco | € 35 | % |

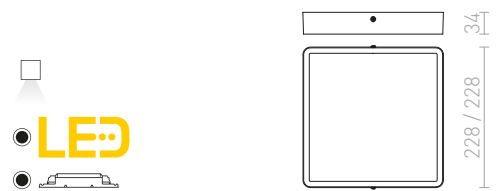





## HUE

Plafoniera/applique quadrata molto sottile con angoli arrotondati e con diodo LED ad alta luminosità e dimmerabile. Montatura in finiture: cromo, cromo nero, nichel opaco, laccata bianco o nell'imitazione del legno. Dimmerazione TRIAC.

### HUE SQ 9 DIMM DA SOFFITTO

230 V LED 6 W 3000 K 540 lm Ra 80

|        |              |      |   |
|--------|--------------|------|---|
| R13142 | bianco       | € 58 | → |
| R13143 | nero cromato | € 58 | → |
| R13144 | cromo        | € 58 | → |
| R13145 | nichel opaco | € 58 | → |

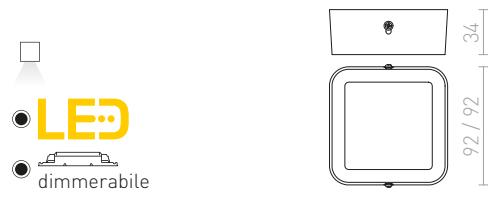

### HUE SQ 17 DIMM DA SOFFITTO

230 V LED 18 W 3000 K 1620 lm Ra 80

|        |                      |       |   |
|--------|----------------------|-------|---|
| R13083 | bianco               | € 120 | → |
| R13084 | nero cromato         | € 120 | → |
| R13085 | cromo                | € 120 | → |
| R13086 | nichel opaco         | € 120 | → |
| R13087 | imitazione di faggio | € 120 | → |

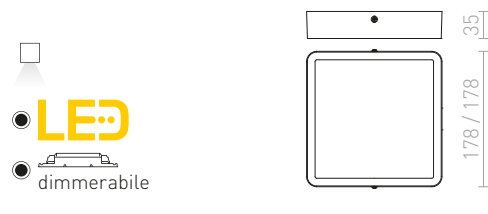

### HUE SQ 22 DIMM DA SOFFITTO

230 V LED 24 W 3000 K 2160 lm Ra 80

|        |              |       |   |
|--------|--------------|-------|---|
| R13088 | bianco       | € 138 | → |
| R13089 | nero cromato | € 129 | → |
| R13090 | cromo        | € 129 | → |
| R13091 | nichel opaco | € 129 | → |

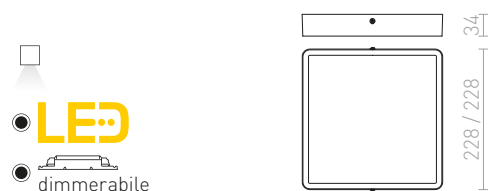







## SOCORRO

Plafoniera/applique piatta con LED integrato.

### SOCORRO R 300 PLAFONIERA/APPLIQUE

230 V LED 24 W 3000 K 1920 lm Ra 80

R12973 bianco

€ 58

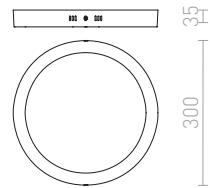

## SLENDER

Plafoniera/applique piatta con diodo LED.

### SLENDER R 12 PLAFONIERA/APPLIQUE

230 V LED 6 W 3000 K 540 lm Ra 80

R11281 nichel opaco

€ 17

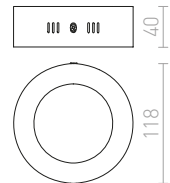
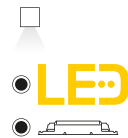

### SLENDER SQ 12 PLAFONIERA/APPLIQUE

230 V LED 6 W 3000 K 540 lm Ra 80

R11284 nichel opaco

€ 17

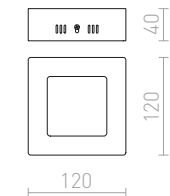
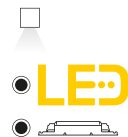

### SLENDER SQ 22 PLAFONIERA/APPLIQUE

230 V LED 18 W 3000 K 1620 lm Ra 80

R11285 nichel opaco

€ 32

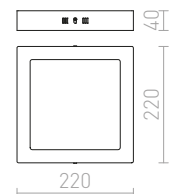
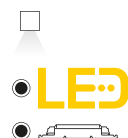







## MELISA

Plafoniera/applique con LED integrato, paralume in acrilico bianco latte e montatura in alluminio spazzolato.

### MELISA 25 DA SOFFITTO

230 V LED 12 W 3000 K 840 lm Ra 80

R11296 alluminio

€ 58

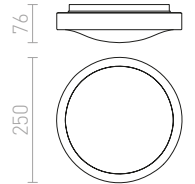

### MELISA 52 DA SOFFITTO

230 V LED 40 W 3000 K 2200 lm Ra 80

R11297 alluminio

€ 120

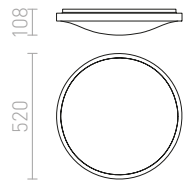

## SEMPRE

Plafoniera con LED integrato e paralume in acrilico bianco latte.

### SEMPRE R 55 DA SOFFITTO

230 V LED 56 W 3000 K 3920 lm Ra 80

R12434 acrilico

€ 178

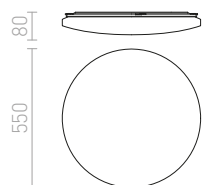

### SEMPRE SQ 63 DA SOFFITTO

230 V LED 76 W 3000 K 5320 lm Ra 80

R12439 acrilico

€ 215

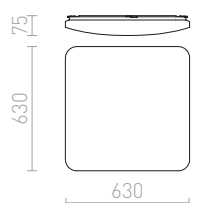









## SEMPRE

Plafoniera con LED integrato, paralume in acrilico bianco latte e sensore di movimento integrato.

### SEMPRE SQ 33 SENSORE DA SOFFITTO

230 V LED 24 W 3000 K 1680 lm Ra 80

R12440 acrilico

€ 120

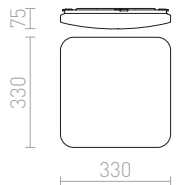

### SEMPRE SQ 43 SENSORE DA SOFFITTO

230 V LED 36 W 3000 K 2520 lm Ra 80

R12441 acrilico

€ 150

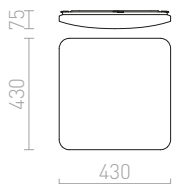

### SEMPRE SQ 53 SENSORE DA SOFFITTO

230 V LED 56 W 3000 K 3920 lm Ra 80

R12442 acrilico

€ 188

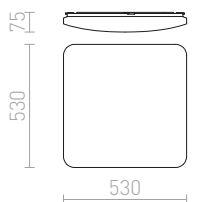

### SEMPRE SQ 63 SENSORE DA SOFFITTO

230 V LED 76 W 3000 K 5320 lm Ra 80

R12443 acrilico

€ 129

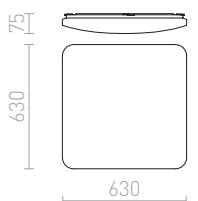

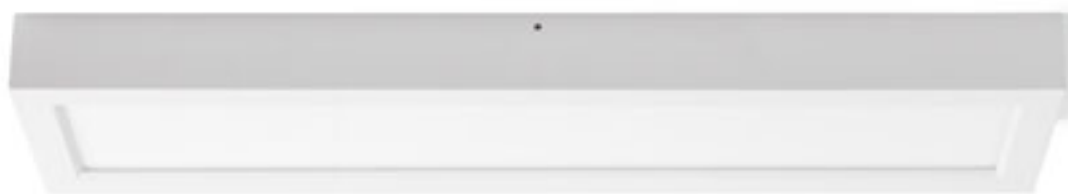

## STRUCTURAL

Plafoniera montata in superficie con LED e struttura in alluminio laccato. Driver integrato compreso.

**STRUCTURAL LED 60x15 PLAFONIERA/APPLIQUE**  
230 V LED 22 W 3000 K 1370 lm Ra 80

R12064 bianco

€ 120

%

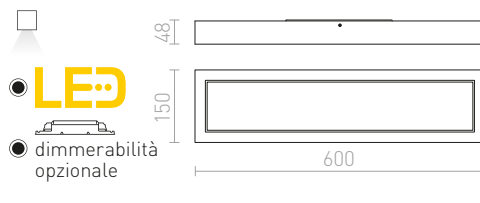

IP65



## TRIDENT PRO

Apparecchio lineare a LED industriale, adatto per montaggio a soffitto o per la sospensione con il set G13672. Potenza alta e la protezione IP65. Fornito senza il set da sospensione e senza cavo di alimentazione. Possibilità di connettere in serie.

**TRIDENT PRO 120 CORPO**

230 V LED 40 W 4000 K 5200 lm Ra 80 IP65

G13670 grigio/acrilato opaco

€ 58

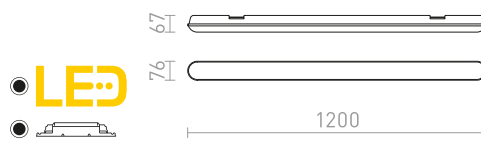

**TRIDENT PRO 150 CORPO**

230 V LED 60 W 4000 K 7800 lm Ra 80 IP65

G13671 grigio/acrilato opaco

€ 88

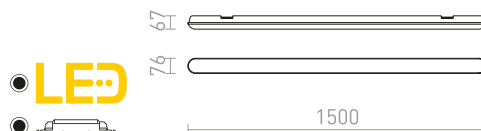







## LAMPADE DA PARETE

|                      |         |
|----------------------|---------|
| PER BAGNO            | 184-209 |
| DECORATIVE           | 210-219 |
| COMBinate            | 220-223 |
| A BRACCIO            | 224-227 |
| DI GESSO             | 228-237 |
| LUCE INDIRETTA       | 238-239 |
| UP-DOWN              | 240-255 |
| DA QUADRO            | 256-259 |
| LAMPADE SOTTOPENSILE | 260-261 |
| LUCI SEGNAPASSO      | 262-265 |



# DA PARETE PER BAGNO



**SWAY**  
184-185



**PANON SHORT**  
184-185



**PANON LONG**  
184-185

184-209



**IMPERISO 60**  
184-185



**MONET 84**  
186-187



**LUISA 60**  
186-187



**CASSAMBA 60**  
186-187



**PALEA 300**  
188-189



**PALEA 500**  
188-189

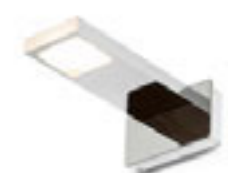

**PARAGNA**  
188-189



**MAREA 60**  
188-189



**YOLO SQ**  
190-191



**PARIS**  
190-191



**SAVOY 24**  
190-191



**BALEA 500**  
190-191



**LEVIA 60**  
192-193



**LEVIA 90**  
192-193



**LEVIA 120**  
192-193



**AMENITY 60**  
194-195



**AMENITY 90**  
194-195



**AMENITY 120**  
194-195



**PERISA 60**  
194-195



**PERISA 90**  
194-195



**IMPERIA 90**  
196-197



**IMPERIA 120**  
196-197



**ADAGIO 60**  
196-197



**MARINA LED 60**  
198-199



**MARINA LED 90**  
198-199



**MARINA LED 120**  
198-199



**CRESCENDO 90**  
200-201



**MIRANDA 60**  
200-201



**MIRANDA 120**  
200-201



**TAMPA 60**  
202-203



**TAMPA**  
202-203



**FLORIO 49**  
202-203



**CORAZON 60**  
204-205



**CORAZON 90**  
204-205



**FAO 90**  
204-205



**LINN I**  
206-207



**LINN III**  
206-207



**BOLLY III**  
206-207



**VALTO I**  
206-207



**VALTO III**  
206-207



**DUBLIN I**  
208-209



**DUBLIN II**  
208-209



**DUBLIN III**  
208-209



**DUBLIN IV**  
208-209

## DA PARETE DECORATIVE

210-219



**CALLUM RR4 250**  
210-211



**CALLUM RL2 250**  
210-211



**CALLUM RD2 250**  
210-211



**GLANS RR2 150**  
212-213



**GLANS RB2 165**  
212-213



**RON W 15/25**  
214-215



**LOPE W 25/14**  
214-215



**SELENA**  
216-217



**SOLARIS**  
216-217



**JERSEY**  
218-219



**SHARP**  
218-219



**HUDSON**  
218-219

## DA PARETE COMBinate

220-223



**VERSA**  
220-221



**VERSINA**  
220-221



**PERTH**  
220-221



**TIARA**  
222-223



**PLAZA**  
222-223



**TAINA**  
222-223

## DA PARETE A BRACCIO

224-227



**MADISON W**  
224-225



**ASHLEY**  
224-225



**MONTANA**  
226-227



**ANTE**  
226-227

## DA PARETE DI GESSO

228-237



**GINA S**  
228-229



**CHIC**  
228-229



**BODIE**  
228-229



**BENITA**  
228-229



**GRANITA II**  
228-229



**GAN**  
230-231



**VERITA**  
230-231



**COWLEY**  
230-231



**CRESCENT**  
232-233



**CRESCENT L**  
232-233



**SID**  
232-233



**JACK SQ**  
234-235



**JACK RC S**  
234-235



**HAY**  
234-235



**KUBIS**  
234-235



**ROLO 36**  
236-237



**ROLO 45**  
236-237



**WIM**  
236-237

## DA PARETE LUCE INDIRETTA

238-239



**FOND**  
238-239



**BRUXEL 12**  
238-239



**VIENNA**  
238-239



**ATHI**  
238-239



**ATLANTA 13**  
238-239

## DA PARETE UP-DOWN

240-255



**TITO R**  
240-241



**TITO SQ**  
240-241



**CARRE**  
240-241



**DAFFY**  
242-243



**BIARITZ**  
242-243



**TUBA W**  
242-243



**MIDZACK**  
242-243



**MOIRE I**  
244-245



**MOIRE II**  
244-245



**MICO I**  
244-245



**MICO II**  
244-245



**MARIO**  
246-247



**REEM**  
246-247



**ROZA**  
246-247



**TAPA**  
246-247



**NAXOS**  
246-247



**TRIP SQ**  
248-249



**ESSEX**  
248-249



**ONYX**  
248-249



**DIDO**  
248-249



**KORSO II**  
248-249



**PEKKO**  
248-249



**AGATE II**  
250-251



**DESMOND II**  
250-251



**NICK II**  
250-251



**UKKO**  
250-251



**CHLOE**  
252-253



**LEA**  
252-253



**TORINO**  
252-253



**NEMAN**  
252-253



**TWIST**  
254-255



**PRIO LED 62**  
254-255

## DA PARETE DA QUADRO



**SWAY**  
256-257



**SWING**  
256-257



**PANON LONG**  
256-257





**LUISA 60**  
258-259



**IMPERISO 60**  
258-259



**MAREA 60**  
258-259

## DA PARETE LAMPADE SOTTOPENSILE

260-261



**FLORIO 49**  
260-261



**CORAZON 60**  
260-261



**CORAZON 90**  
260-261

## DA PARETE LUCI SEGNAPASSO

262-265



**AQILA R**  
262-263



**AQILA RC**  
262-263



**AMBER**  
262-263



**TICO I**  
262-263



**AQILA SQ**  
262-263



**BOBO R**  
264-265



**BOBO RC**  
264-265



**BOBO SQ**  
264-265

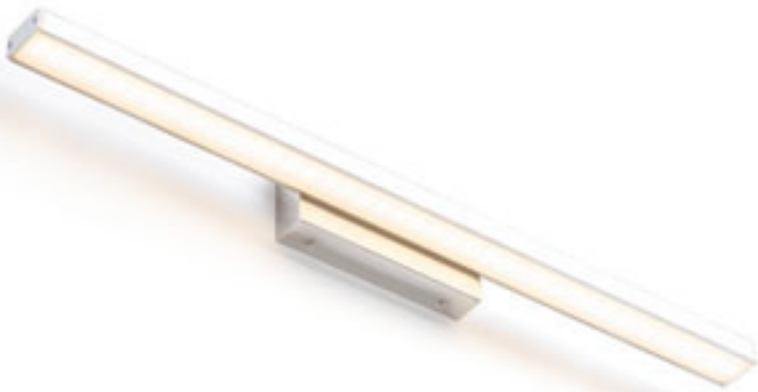

IP44



IP44

## PANON

Applique lineare con LED integrato e con base centrale.  
Adatta per ambienti umidi.

### PANON SHORT DA PARETE

230 V LED 18 W 3000 K 1700 lm Ra 80 IP44

R12949 cromo

€ 138

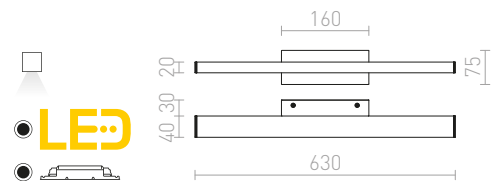

### PANON LONG DA PARETE

230 V LED 12 W 3000 K 900 lm Ra 80 IP44

R12950 cromo

€ 120





IP44

## SWAY

Applique lineare con LED integrato e funzione inclinabile, adatta sopra quadri o specchi.

### SWAY PER BAGNO

230 V LED 12 W 3000 K 1060 lm Ra 80 IP44

R12951 cromo

€ 120

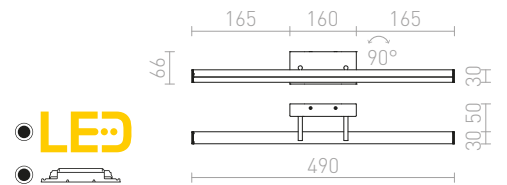

IP44

## IMPERISO

Lampada da specchio lineare a LED con parte anteriore orientabile in asse orizzontale. Adatta per ambienti umidi.

### IMPERISO 60

230 V LED 18 W 3000 K 1769 lm Ra 80 IP44

R13555 bianco

€ 248

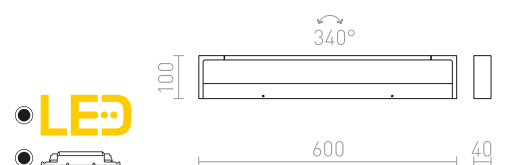



IP44



## MONET

Lampada sopra specchio lineare a LED, adatta per ambienti umidi.

### MONET 84 DA PARETE

230 V LED 29 W 3000 K 1892 lm Ra 80 IP44

R13337 acrilico/cromo

€ 278 



LED

50

250

87

835



IP54

## LUISA

Lampada da specchio lineare a luci LED orientate verso il basso. Adatta per ambienti umidi.

### LUISA 60 DA PARETE

230 V LED 12 W 3000 K 1138 lm Ra 80 IP54

R13735 bianco

€ 150

R13853 nero

€ 150

NEW

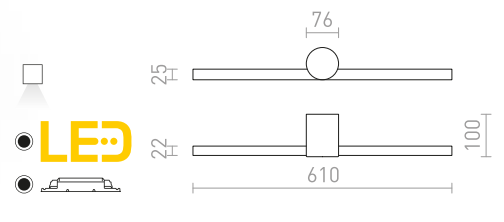

IP44

## CASSAMBA

Tubo LED da bagno a parete su base rettangolare. Utilizzando l'interruttore all'interno della base, è possibile regolare il colore della luce: 3000K o 4000K.

### CASSAMBA 60 DA PARETE

230 V LED 12 W 3000 K 4000 K 700 lm Ra 80 IP44

R13888 nero/acrilico

€ 178

R13889 cromo/acrilico

€ 178

NEW

NEW

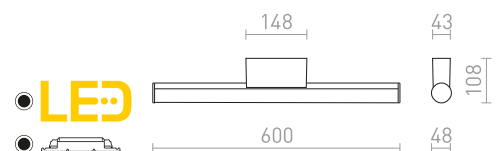





IP44

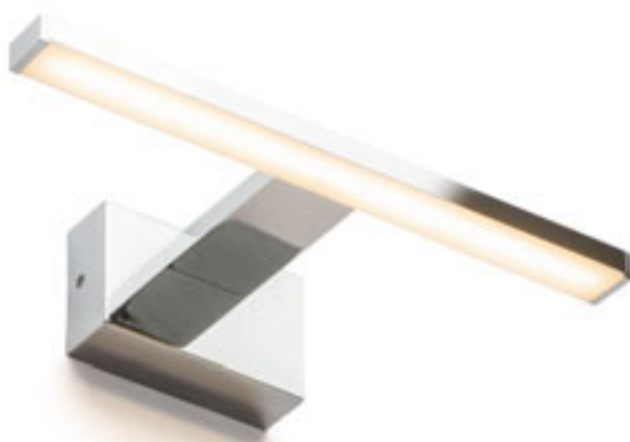

IP44



IP44

## PALEA

Applique per bagno con LED integrato. Adatto per uso in ambienti umidi.

### PALEA 500

230 V LED 7 W 3000 K 308 lm Ra 80 IP44

R10613 cromo

€ 150

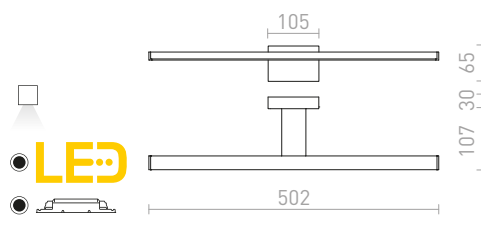

### PALEA 300

230 V LED 4,4 W 3000 K 189 lm Ra 80 IP44

R10614 cromo

€ 120

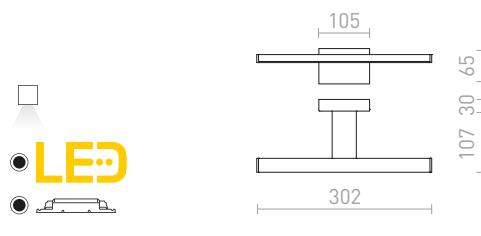

## PARAGNA

Applique per bagno con LED integrato.

### PARAGNA DA PARETE

230 V LED 5,7 W 3000 K 246 lm Ra 80 IP44

R10612 cromo

€ 78

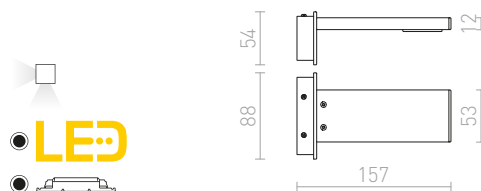



IP44

## MAREA

Lampada da specchio lineare a luci LED orientate verso il basso. Adatta per ambienti umidi.

### MAREA 60 DA PARETE

230 V LED 18 W 3000 K 1954 lm Ra 80 IP44

R13554 bianco

€ 188

R13852 nero

€ 188

NEW

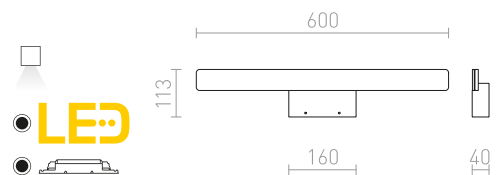

IP44

## PARIS

Lampada per bagno robusto con LED integrato in metallo cromato, adatta per armadi e mensole.

### PARIS PER ARMADIO

230 V LED 3 W  $\angle 120^\circ$  3000 K 210 lm Ra 80 IP44

R12398 cromo

€ 68

%

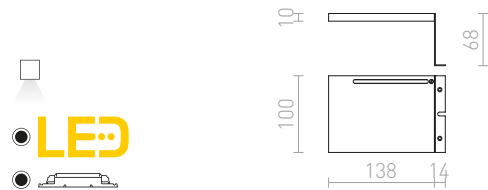

IP44

## SAVOY

Lampada da bagno rettangolare in metallo cromato con LED integrato per illuminazione UP/DOWN. Adatta per armadi e mensole.

### SAVOY 24 PER ARMADIO

230 V LED 8 W  $\angle 120^\circ$  3000 K 300 lm Ra 80 IP44

R12399 cromo

€ 88

%

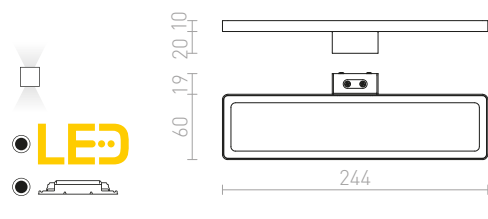

IP44

## BALEA

Luce per bagno lineare con LED integrato e braccio per montaggio su armadi o mensole. Adatta per ambiente umido.

### BALEA 500 PER ARMADIO

230 V LED 7 W  $\angle 120^\circ$  3000 K 370 lm Ra 80 IP44

R12400 cromo

€ 120

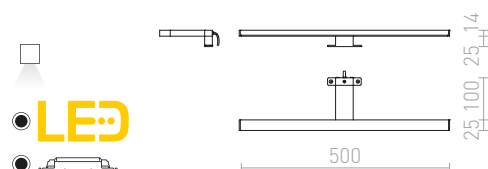



IP44



### YOLO

Luce da bagno con diodo LED integrato, da fissare ad armadio o specchio.

#### YOLO SQ SOPRA SPECCHIO

12 V= LED 4 W 3000 K 215 lm Ra 80 IP44

R10588 cromo

€ 48 %



LED



G14018

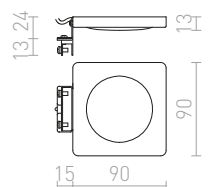





## LEVIA

Applique lineare per bagno con LED integrato adatto per ambienti umidi. Montabile su un armadio o una mensola utilizzando il set di agganci R12581.

### LEVIA 60 DA PARETE

230 V LED 12 W  $\angle 120^\circ$  3000 K 900 lm Ra 80 IP44

R12401 alluminio € 150

R12402 cromo € 150

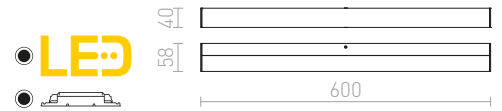

### LEVIA 90 DA PARETE

230 V LED 18 W  $\angle 120^\circ$  3000 K 1300 lm Ra 80 IP44

R12403 alluminio € 198

R12404 cromo € 215



### LEVIA 120 DA PARETE

230 V LED 24 W  $\angle 120^\circ$  3000 K 1700 lm Ra 80 IP44

R12405 alluminio € 248

R12406 cromo € 258

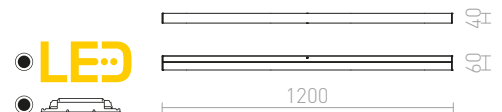

IP44

IP44

IP44

## LEVIA

Agganci cromati per montaggio su armadi, adatte con prodotti: R102401, R12402, R12403, R12404, R12405 a R12406.

### LEVIA KIT DI MANIGLIE PER ARMADI

R12581 cromo € 3.80

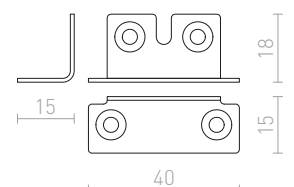



IP44

IP44

## PERISA

Applique lineare per tubi fluorescenti ideale per installazione sopra specchio. Disponibile in alluminio spazzolato o con rifinitura laccata bianca. Adatto per ambienti umidi.

### PERISA 60 DA PARETE

230 V G5 14 W IP44

R10262 bianco

€ 98

%

R10264 alluminio spazzolato

€ 120

%

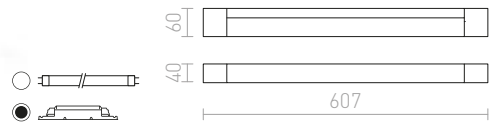

### PERISA 90 DA PARETE

230 V G5 21 W IP44

R10263 bianco

€ 78

%

R10265 alluminio spazzolato

€ 120

%

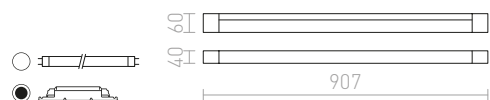



IP44



IP44



IP44



### AMENITY

Applique lineare con LED integrato e rifiniture cromate. Adatta per ambienti umidi.

#### AMENITY 120 DA PARETE

230 V LED 14 W 3000 K 830 lm Ra 80 IP44

R12641 cromo

€ 229



#### AMENITY 90 DA PARETE

230 V LED 11 W 3000 K 580 lm Ra 80 IP44

R12640 cromo

€ 215



#### AMENITY 60 DA PARETE

230 V LED 8 W 3000 K 400 lm Ra 80 IP44

R12639 cromo

€ 178







IP44

**ADAGIO**

Applique quadrato robusto con diffusore in plastica e accessori cromati. Adatto per ambienti umidi.

**ADAGIO 60 DA PARETE**

230 V G5 24 W IP44

R12217 cromo

€ 120 %

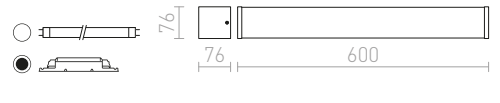

IP44

**IMPERIA**

Applique per bagno rettangolare con copertura in plastica ed accessori cromati. Adatto per ambienti umidi.

**IMPERIA 120 DA PARETE**

230 V G5 28 W IP44

R12219 cromo

€ 158 %



IP44

**IMPERIA 90 DA PARETE**

230 V G5 39 W IP44

R12218 cromo

€ 150 %

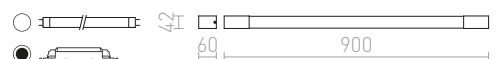



IP44



IP44



IP44

## MARINA

Applique lineare da parete con LED integrato e illuminazione UP/DOWN. Adatta per ambienti umidi.

### MARINA LED 60 DA PARETE

230 V LED 14 W 3000 K 550 lm Ra 80 [IP44](#)

R11993 cromo

€ 178

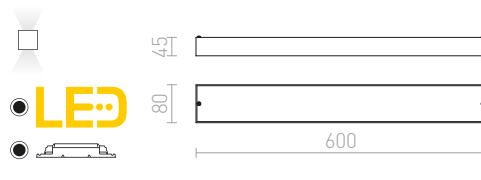

### MARINA LED 90 DA PARETE

230 V LED 19 W 3000 K 800 lm Ra 80 [IP44](#)

R11996 cromo

€ 238

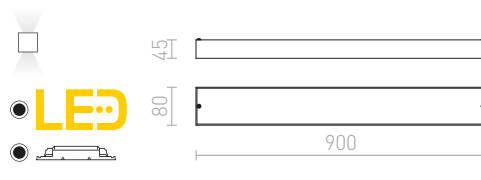

### MARINA LED 120 DA PARETE

230 V LED 25 W 3000 K 950 lm Ra 80 [IP44](#)

R11998 cromo

€ 360

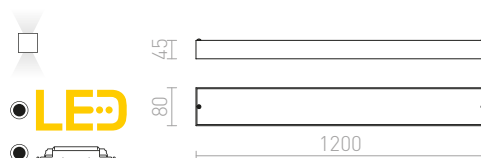







IP44

### MIRANDA

Applique lineare con LED integrato adatta per ambienti umidi.

#### MIRANDA 60 DA PARETE

230 V LED 8 W 3000 K 470 lm Ra 80 IP44

R12407 cromo

€ 150

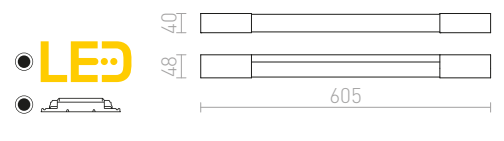

#### MIRANDA 120 DA PARETE

230 V LED 14 W 3000 K 1000 lm Ra 80 IP44

R12409 cromo

€ 220



IP44



IP44

### CRESCENDO

Applique per bagno arrotondato con copertura in plastica e accessori cromati. Adatta per ambienti umidi.

#### CRESCENDO 90 DA PARETE

230 V G5 39 W IP44

R12220 cromo

€ 150





IP44



## FLORIO

Applique per bagno con LED integrato e presa per dispositivi a basso consumo fino a 100W.

### FLORIO 49

230 V LED 8 W 3000 K 640 lm Ra 80 IP44

R12903 bianco

€ 88

R12904 cromo

€ 98



IP44

## TAMPA

Applique lineare per bagno con LED integrato da collocare sopra specchi. Adatta per ambienti umidi e con opzione di acquistare rifiniture in diversi colori (R12906, R12907, R12908).

### TAMPA 60 DA PARETE SENZA COPERTURA

230 V LED 15 W 3000 K 1400 lm Ra 80 IP44

R12905 bianco

€ 68



## TAMPA

Rifiniture separate in tre colori da utilizzare con R12905.

### TAMPA COPERTURE 2 PEZZI

R12906 bianco

€ 2.20

R12907 grigio argento

€ 3.80

R12908 cromo

€ 5.50

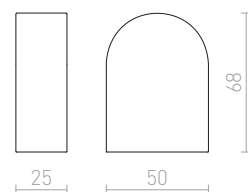









IP44

## FAO

Applique lineare adatta per ambienti umidi. Con struttura in acrilico bianco latte.

### FAO 90 DA PARETE

230 V G5 21 W IP44

R10491 cromo

€ 78 %



IP44

## CORAZON

Applique lineare con LED integrato adatta per ambienti umidi.

### CORAZON 60

230 V LED 15 W 3000 K 1200 lm Ra 80 IP44

R12901 cromo

€ 78

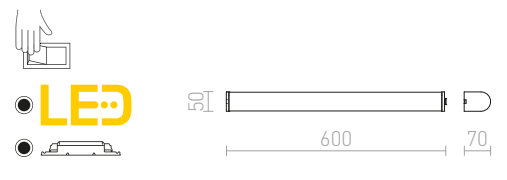

IP44

### CORAZON 90

230 V LED 20 W 3000 K 1600 lm Ra 80 IP44

R12902 cromo

€ 120

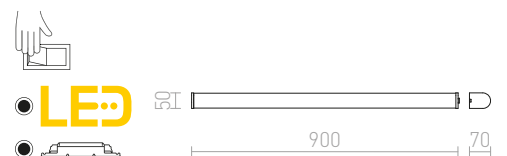



IP44



IP44

## LINN

Plafoniera/applique con vetro opalino e con base cromata. Adatta per ambienti umidi.

### LINN III APPLIQUE/PLAFONIERA

230 V G9 LED 3x3 W IP44

R13703 vetro opalino/cromo

€ 120

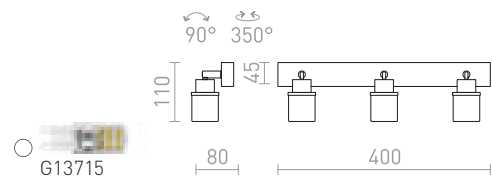

### LINN I DA PARETE

230 V G9 LED 3 W IP44

R13695 vetro opalino/cromo

€ 48

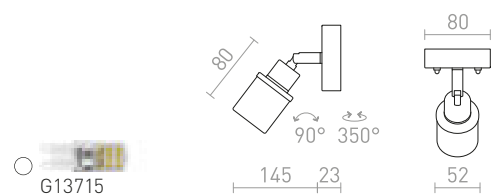



IP44



## BOLLY

Apparecchio con vetri opalini su base cromata. Adatto per ambienti umidi.

### BOLLY III APPLIQUE/PLAFONIERA

230 V G9 LED 3x3 W IP44

R13691 vetro opalino/cromo

€ 129

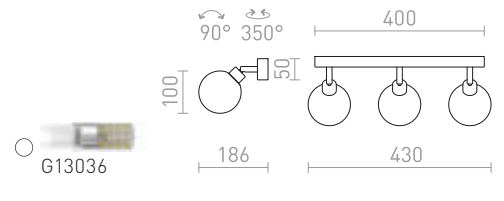

IP44

## VALTO

Applique o plafoniera con riflettori reclinabili per sorgenti luminosi LED con portalampana GU10. Adatta per ambienti umidi.

### VALTO III APPLIQUE/PLAFONIERA

230 V GU10 LED 3x5 W IP44

R13704 cromo

€ 88

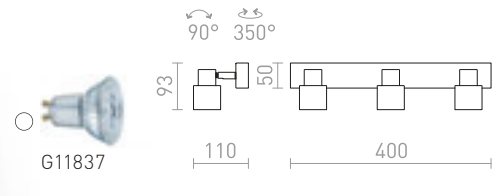

IP44

### VALTO I DA PARETE

230 V GU10 LED 5 W IP44

R13696 cromo

€ 48

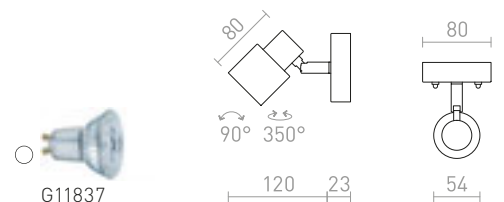







IP44

### DUBLIN

Faretto cromato adatto per ambienti umidi.

#### DUBLIN I APPLIQUE/PLAFONIERA

230 V GU10 9 W IP44

R13377 cromo

€ 48

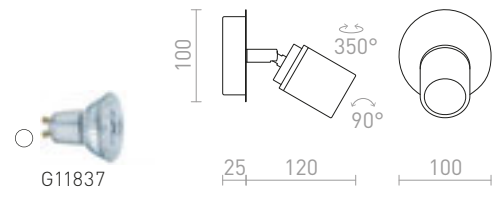

IP44

#### DUBLIN II APPLIQUE/PLAFONIERA

230 V GU10 2x9 W IP44

R13378 cromo

€ 78

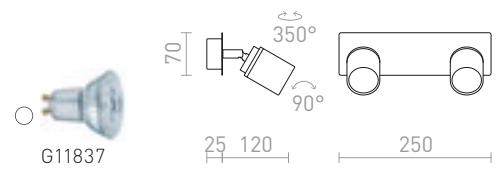

IP44

#### DUBLIN III APPLIQUE/PLAFONIERA

230 V GU10 3x9 W IP44

R13379 cromo

€ 98

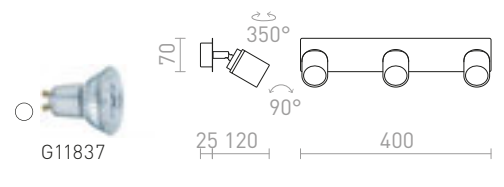

IP44

#### DUBLIN IV APPLIQUE/PLAFONIERA

230 V GU10 4x9 W IP44

R13380 cromo

€ 129

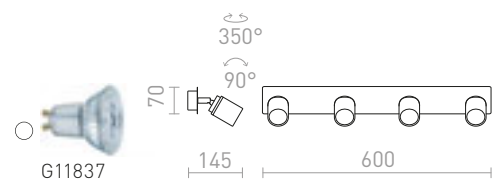





## CALLUM

Lampada da parete realizzata in stampa 3D. Il paralume è realizzato in materiale PLA ecologico, completamente degradabile.

### CALLUM RD2 250 DA PARETE

230 V LED E27 10 W

R13999 bianco/Eco PLA

€ 129

NEW

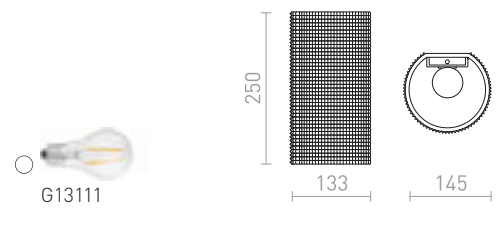

### CALLUM RR4 250 DA PARETE

230 V LED E27 10 W

R13997 bianco/Eco PLA

€ 129

NEW

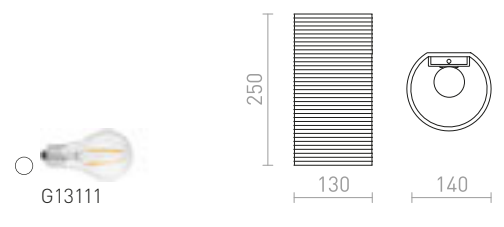

### CALLUM RL2 250 DA PARETE

230 V LED E27 10 W

R13998 bianco/Eco PLA

€ 129

NEW

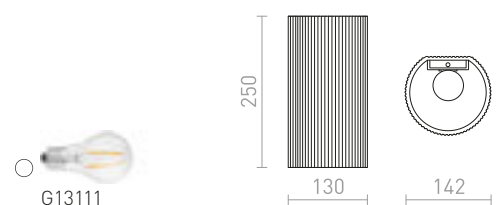



## GLANS

Lampada da parete realizzata in stampa 3D.  
Il paralume è realizzato in materiale PLA ecologico,  
completamente degradabile.

### GLANS RB2 165 DA PARETE

230 V LED G9 5 W

R14001 bianco/Eco PLA

€ 120 **NEW**

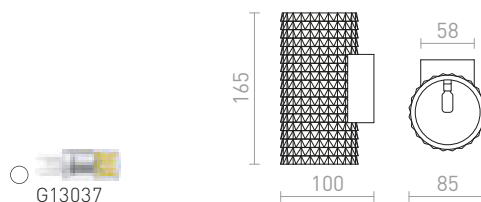

### GLANS RR2 150 DA PARETE

230 V LED G9 5 W

R14000 bianco/Eco PLA

€ 120 **NEW**

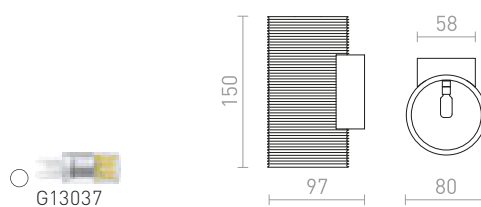













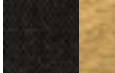

## RON

Lampada da parete con paralume in tessuto.

### RON W 15/25 DA PARETE

230 V E27 28 W

|   |  |       |
|---|--|-------|
|  | <b>R11368</b><br>policotone nero/lamina di rame  | € 158 |
|  | <b>R11464</b><br>policotone nero/lamina d'oro    | € 158 |
|  | <b>R11492</b><br>policotone bianco/PVC bianco    | € 120 |
|  | <b>R11509</b><br>Chintz albicocca/PVC bianco     | € 120 |
|  | <b>R11519</b><br>Chintz arancione/PVC bianco     | € 120 |
|  | <b>R11548</b><br>Chintz menta/lamina d'argento   | € 129 |
|  | <b>R11557</b><br>Chintz grigio chiaro/PVC bianco | € 120 |
|  | <b>R11567</b><br>Chintz limetta/PVC bianco       | € 120 |
|  | <b>R11575</b><br>Monaco benzina/PVC argento      | € 129 |
|  | <b>R11586</b><br>grigio piccione/PVC argento     | € 129 |

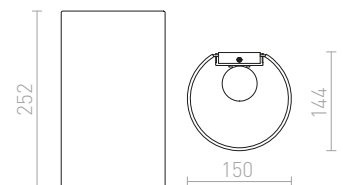



## LOPE

Lampada da parete con paralume in tessuto.

### LOPE W 25/14 DA PARETE

230 V E27 28 W

|  |  |        |
|--|--|--------|
|  | <b>R11365</b><br>policotone nero/lamina d'oro    | € 150  |
|  | <b>R11377</b><br>policotone nero/lamina di rame  | € 150  |
|  | <b>R11381</b><br>Chintz oliva/lamina d'argento   | € 78 % |
|  | <b>R11383</b><br>Chintz menta/lamina d'argento   | € 150  |
|  | <b>R11504</b><br>policotone bianco/PVC bianco    | € 120  |
|  | <b>R11512</b><br>Chintz albicocca/PVC bianco     | € 120  |
|  | <b>R11522</b><br>Chintz arancione/PVC bianco     | € 120  |
|  | <b>R11560</b><br>Chintz grigio chiaro/PVC bianco | € 120  |
|  | <b>R11570</b><br>Chintz limetta/PVC bianco       | € 120  |

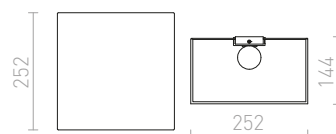



## SELENA

Lampadina applique tessile con interruttore a tirante.  
Il paralume può essere orientato su un asse.

### SELENA DA PARETE

230 V E27 15 W

R13651 nero

€ 120 ➔



G13014

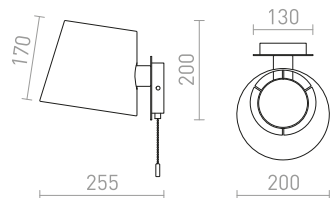



## SOLARIS

Lampada da parete in vetro con base laccata nera.  
Adatta a sorgenti luminose a LED con filettatura E14.

### SOLARIS APPLIQUE/PLAFONIERA

230 V LED E14 7 W

**R13994** vetro trasparente/nero

€ 78 NEW

**R13995** vetro smerigliato/nero

€ 78 NEW

**R13996** vetro fumé/nero

€ 78 NEW



G13098

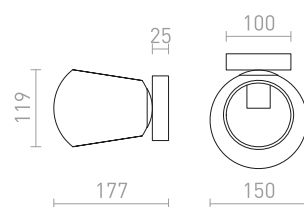





## HUDSON

Lampada da parete con base cromata e cavo verticale, rifinito con un paralume cilindrico di tessuto.

### HUDSON DA PARETE

230 V E27 28 W

R13284 bianco/cromo

€ 138

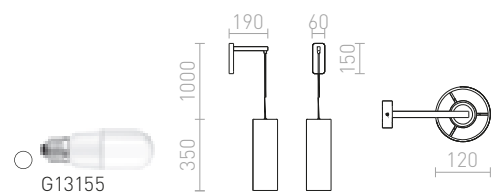



## SHARP

Lampada da parete con paralume in tessuto e interruttore sulla base.

### SHARP DA PARETE

230 V E27 42 W

**R12481** nero/cromo

€ 78



G13026

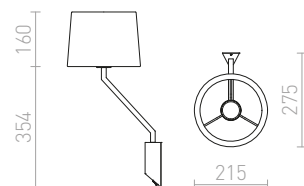

## JERSEY

Lampada da parete elegante con funzione inclinabile. Paralume è ricoperto da tessuto strutturato.

### JERSEY DA PARETE

230 V E27 42 W

**R11976** bianco/cromo

€ 178

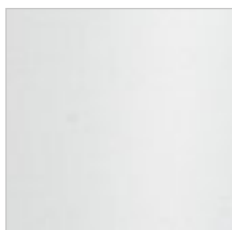

G13026

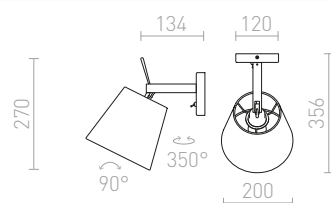



## VERSA

Applique con paralume di tessuto. Collo flessibile  
 addizionale con riflettore a diodi LED. Due sorgenti  
 luminose possono essere controllate separatamente  
 tramite interruttori a levetta posizionati sulla base.

### VERSA DA PARETE CON PARALUME

230 V E27 LED 42 W + 3 W  $\angle 40^\circ$  3000 K 240 lm Ra 80

**R10580** bianco/nichel opaco

**€ 178**



G13026  
**LED**

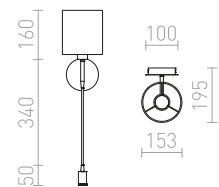

## VERSINA

Lampada da parete con paralume in tessuto,  
 completata da riflettore a diodo LED su collo di cigno.  
 Due sorgenti luminose possono essere controllate  
 separatamente tramite interruttori sulla base  
 dell'apparecchio.

### VERSINA CON PARALUME

230 V E27 LED 28 W + 3 W  $\angle 25^\circ$  3000 K 180 lm Ra 80

**R12955** bianco/cromo

**€ 129**



G13026  
**LED**

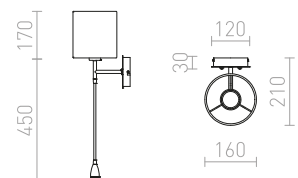

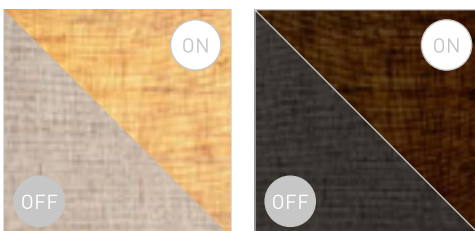

## PERTH

Appliche con paralume quadrato tessile, con collo flessibile e con proiettore a diodo LED. Apparecchio con due sorgenti luminose che possono essere controllati autonomamente dall'interruttore girevole posizionato sulla base quadrata dell'apparecchio.

### PERTH DA PARETE CON FARETTO A LED

230 V E14 LED 15 W + 3 W  $\angle 30^\circ$  3000 K 150 lm Ra 80

**R13661** beige/bianco/cromo

€ 178

**R13662** nero/nero/cromo

€ 178



G13572

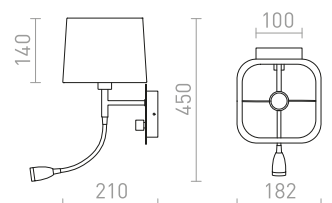





## PLAZA

Lampada da parete con paralume in tessuto strutturato e riflettore da lettura a LED 3W, controllabili entrambi separatamente da interruttori posti sulla base.

**PLAZA DA PARETE CON FARETTO A LED**  
230 V E27 LED 42 W + 3 W 3000 K 140 lm Ra 80

**R11982** bianco/cromo

**€ 188**



G13026

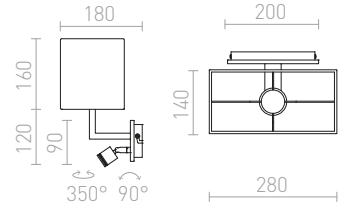

## TIARA

Applique con due sorgenti luminose a LED integrate completato con illuminazione di sopra indiretta. Due sorgenti luminose regolabili separatamente tramite interruttori posti sulla base dell'apparecchio.

**TIARA DA PARETE**  
230 V LED 2x3 W  $\angle 25^\circ$  3000 K 300 lm Ra 80

**R12957** cromo

**€ 68**

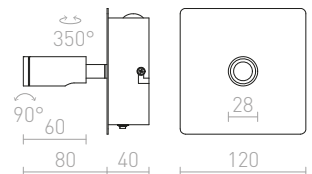



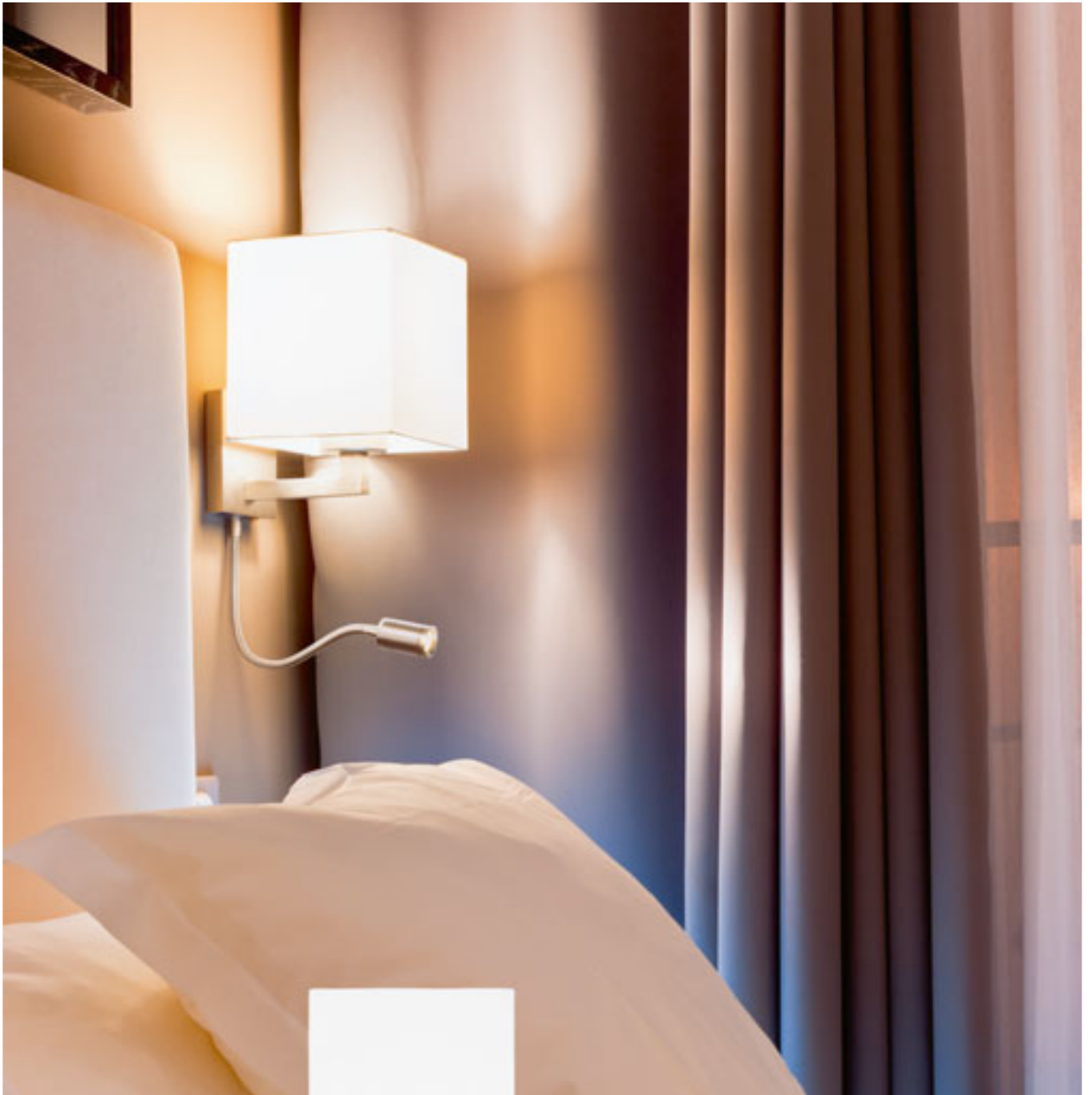

## TAINA

Applique con paralume in tessuto completata da riflettore LED su collo di cigno. Due sorgenti luminose possono essere controllate separatamente dagli interruttori sulla base quadrata dell'apparecchio.

### TAINA CON PARALUME

230 V E27 LED 28 W+3 W  $\angle 25^\circ$  3000 K 180 lm Ra 80

**R12956** bianco/nichel opaco

**€ 138**

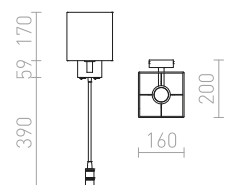



## MADISON

Lampada da parete con doppio braccio regolabile e paralume in tessuto.

### MADISON W DA PARETE

230 V E27 42 W

R12480 bianco/cromo

€ 420

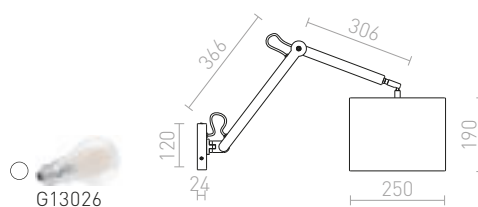
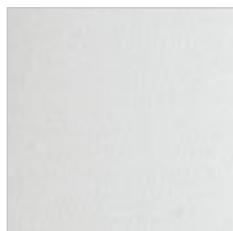

## ASHLEY

Lampada da parete con braccio regolabile, paralume in tessuto e interruttore sulla base.

### ASHLEY DA PARETE

230 V E27 42 W

R12482 bianco/cromo

€ 435

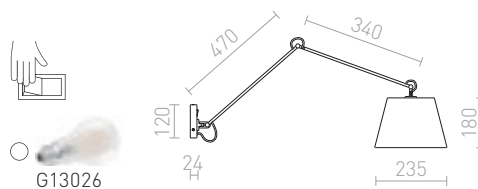
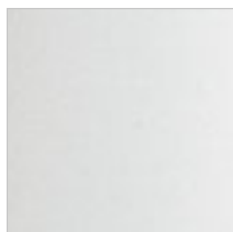









## MONTANA

Lampada da parete di metallo con doppio braccio regolabile e paralume tessile.

### MONTANA DA PARETE

230 V E27 28 W

R13282 bianco/nero/cromo

€ 258



G13014

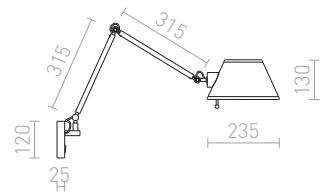

## ANTE

Lampada da lavoro da parete con braccio regolabile e interruttore sulla base.

### ANTE PARETE

230 V E27 28 W

R12651 nero/rame

€ 98

R12652 bianco/nichel opaco

€ 98



G13026

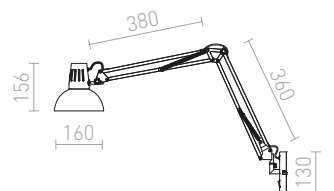





IP65

## GRANITA

Apparecchio da parete da esterno di calcestruzzo, per sorgenti luminose a LED con portalampada GU10.

### GRANITA II DA PARETE

230 V LED GU10 2x5 W IP65

R13792 calcestruzzo/granito chiaro decor

€ 120

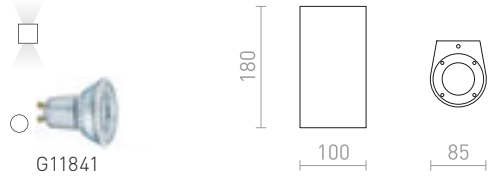

## GINA

Applique in gesso per sorgenti luminose con portalampada G9. L'apparecchio può essere colorato con la vernice da interni.

### GINA S DA PARETE

230 V G9 33 W

R11959 gesso

€ 58

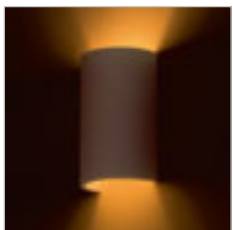
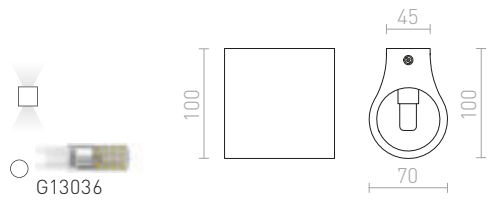

## CHIC

Applique in gesso per illuminazione indiretta. Colorabile con vernici per interni.

### CHIC DA PARETE

230 V G9 25 W

R12999 gesso

€ 58

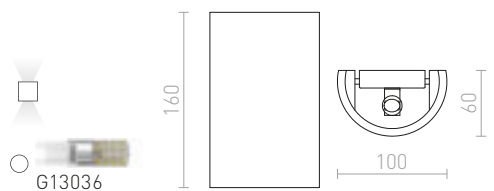

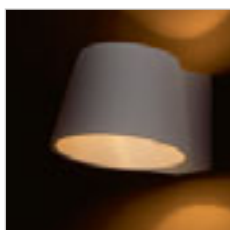

## BENITA

Lampada da parete in gesso per sorgenti luminose con portalampana E14. Può essere colorata con vernici per interni.

### BENITA DA PARETE

230 V E14 25 W

R13520 gesso

€ 88

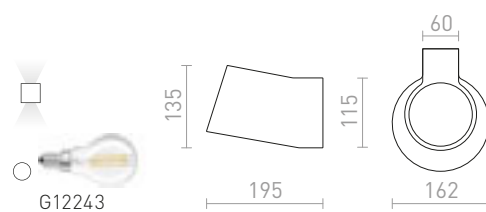

## BODIE

Applique in gesso a LED con illuminazione UP/DOWN. Colorabile con vernici per interni. Compreso un driver integrato.

### BODIE DA PARETE

230 V LED 2x3 W 3000 K 480 lm Ra 80

R13433 gesso

€ 120

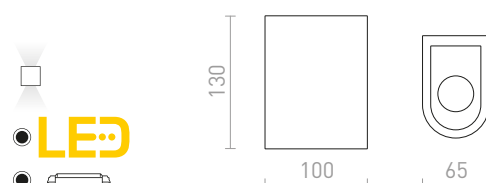



## GAN

Lampada UP/DOWN da parete in gesso. Può essere colorata con vernice da interni.

### GAN DA PARETE

230 V G9 33 W

R12039 gesso

€ 78



## COWLEY

Applique in gesso con illuminazione UP/DOWN.

Parte inferiore ha una copertura in vetro satinato.

La superficie può essere colorata con vernici per interni.

### COWLEY DA PARETE

230 V G9 2x28 W

R13435 gesso

€ 88

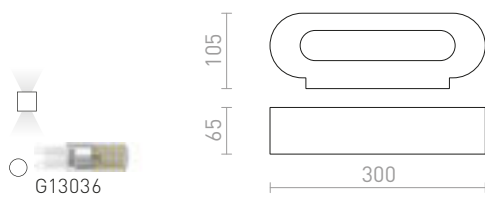

## VERITA

Applique arrotondata in gesso con illuminazione UP/DOWN con portalampada E27. L'apparecchio può essere colorato con la vernice per interni.

### VERITA DA PARETE

230 V E27 33 W

R12365 gesso

€ 120









## CRESCENT

Lampada da parete in gesso con illuminazione UP/DOWN. Base dispone di una copertura in vetro satinato. L'apparecchio può essere colorato con la vernice per interni.

### CRESCENT L DA PARETE

230 V E14 2x28 W

R10451 gesso

€ 129



G11849

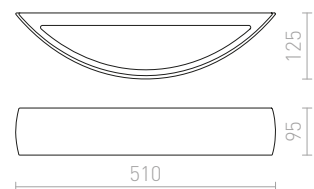



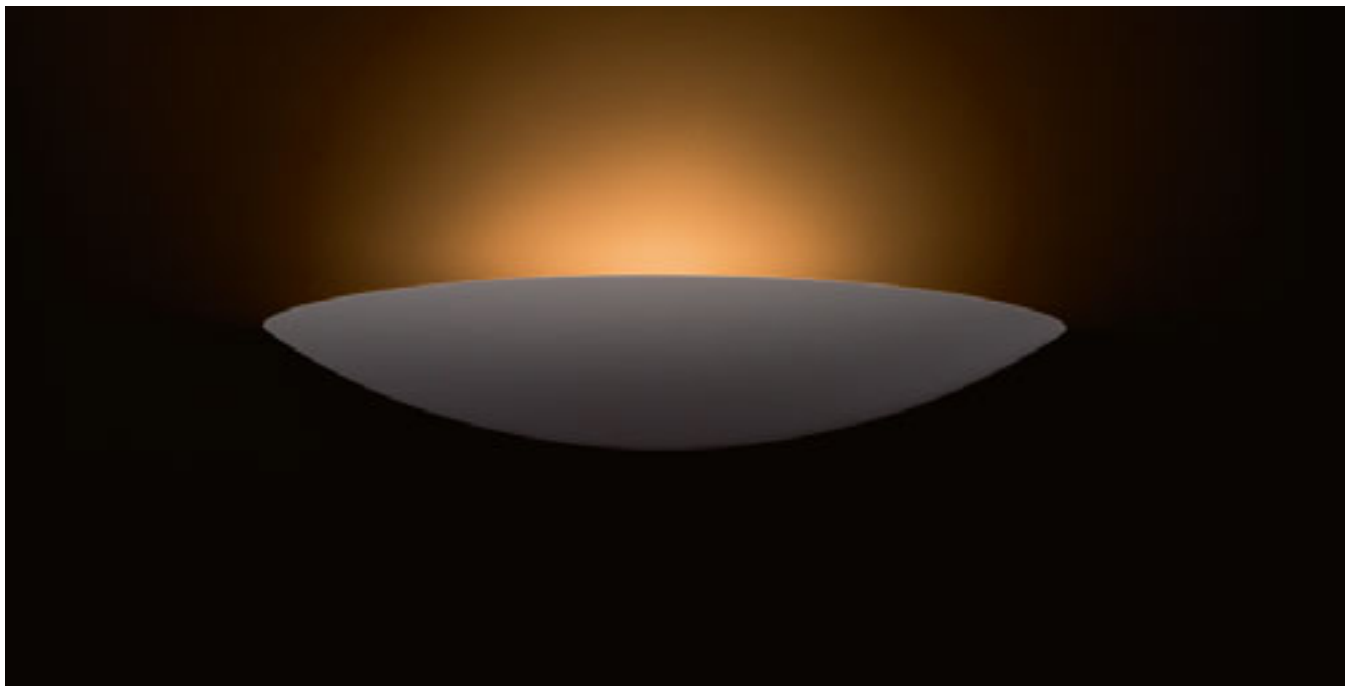

## SID

Apparecchio da parete in gesso per illuminazione indiretta. La superficie può essere colorata con vernici per interni.

### SID DA PARETE

230 V R7s 78mm 48 W

R12998 gesso

€ 88

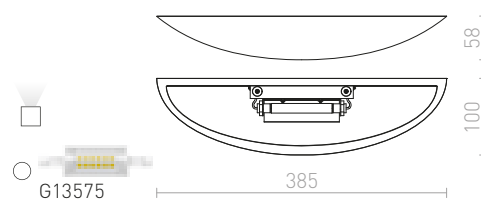

## CRESCENT

Applique in gesso con illuminazione UP/DOWN. Base dispone di una copertura in vetro satinato. Per una sorgente luminosa alogena lineare di 78 mm. L'apparecchio può essere colorato con la vernice per interni.

### CRESCENT DA PARETE

230 V R7s 78mm 80 W

R10266 gesso

€ 88

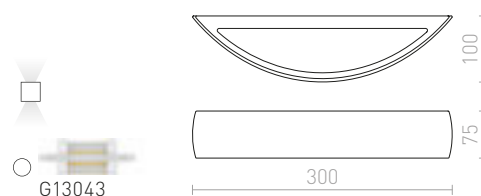



## JACK

Lampada da parete in gesso con illuminazione UP/DOWN. La superficie può essere colorata con vernici per interni.

### JACK SQ DA PARETE

230 V G9 40 W

R10445 gesso

€ 58

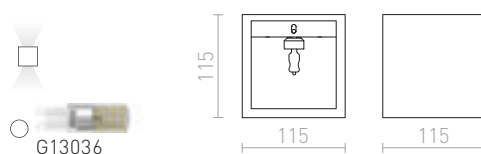

### JACK RC S DA PARETE

230 V G9 33 W

R11960 gesso

€ 48

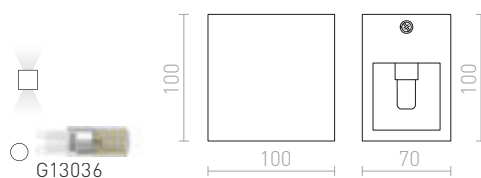

## HAY

Apparecchio da parete in gesso. L'apparecchio può essere colorato con la vernice per interni.

### HAY DA PARETE

230 V G9 40 W

R10448 gesso

€ 48 %

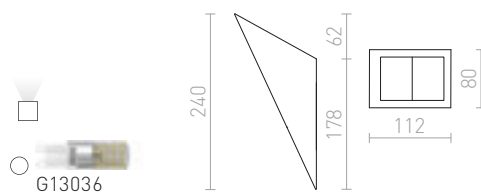



## KUBIS

Applique in gesso con forma asimmetrica. Da installare con apertura più stretta sempre verso alto.

Apparecchio può essere colorato con vernici per interni. Dimensioni base 2x5x10 cm (Lu<sub>x</sub>La<sub>x</sub>Al), dimensioni fori 10x5,5 cm (Lu<sub>1</sub>xLa<sub>1</sub>) 7x8 cm (Lu<sub>2</sub>xLa<sub>2</sub>).

### KUBIS DA PARETE

230 V G9 40 W

R10455 gesso

€ 48 

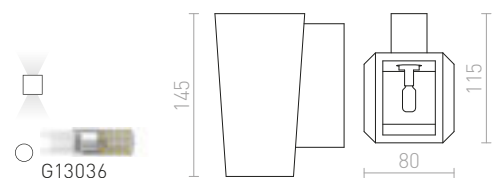



## WIM

Apparecchio da parete in gesso colorabile con vernici per interni.

### WIM DA PARETE

230 V G9 2x40 W

R10465 gesso

€ 68

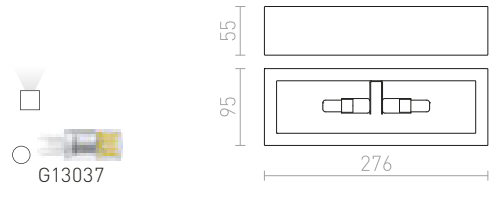

## ROLO

Lampada da parete in gesso con illuminazione UP/DOWN. Parte inferiore dispone di copertura in vetro satinato. La superficie può essere colorata con vernici per interni.

### ROLO 45 DA PARETE

230 V E14 2x11 W

R13436 gesso

€ 120

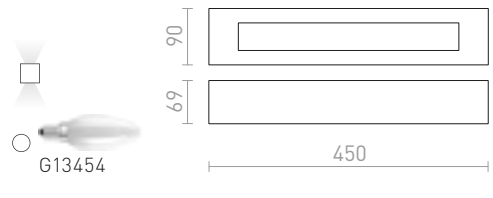

### ROLO 36 DA PARETE

230 V E14 2x30 W

R10446 gesso

€ 68

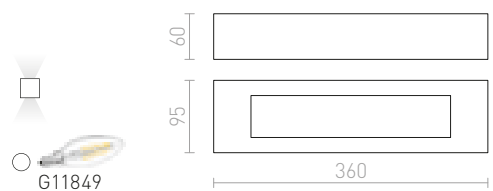







## FOND

Apparecchio rettangolare da parete con LED integrato per illuminazione indiretta.

### FOND DA PARETE

230 V LED 12 W 3000 K 1300 lm Ra 80

R12596 bianco

€ 120

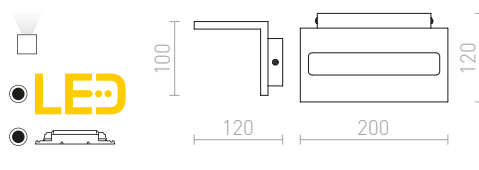

## BRUXEL

Lampada da parete elegante con LED integrato per illuminazione indiretta.

### BRUXEL 12 DA PARETE

230 V LED 6 W 3000 K 650 lm Ra 80

R13842 bianco

€ 88 **NEW**

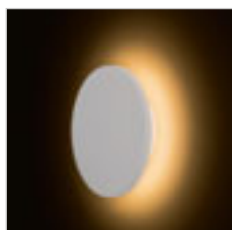
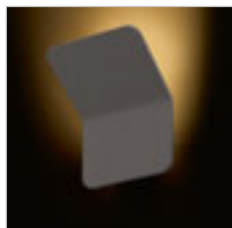
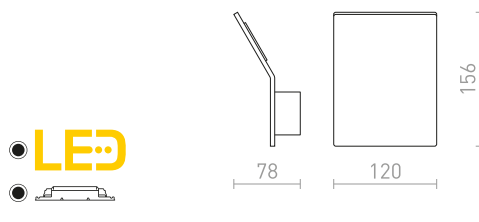

## ATLANTA

Applique circolare a LED per illuminazione indiretta tramite riflessione da parete. Sia per interni che per esterni.

### ATLANTA 13 APPLIQUE/PLAFONIERA

230 V LED 6 W 3000 K 780 lm Ra 80 IP54

R12825 bianco

€ 78





## VIENNA

Apparecchio quadrato con angoli arrotondati da parete con LED integrato per illuminazione indiretta tramite riflessione da parete.

### VIENNA APPLIQUE/PLAFONIERA

230 V LED 9 W 3000 K 1300 lm Ra 80

R12589 bianco

€ 88 %

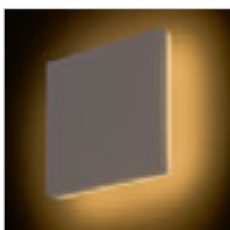
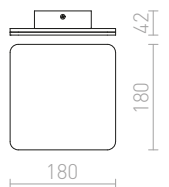

IP54

## ATHI

Applique quadrata con LED integrato per illuminazione indiretta tramite luce riflessa da parete. Sia per interni che per esterni.

### ATHI DA PARETE

230 V LED 9,6 W 3000 K 550 lm Ra 80 IP54

R12551 bianco

€ 120

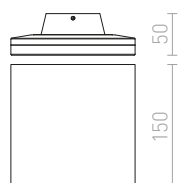

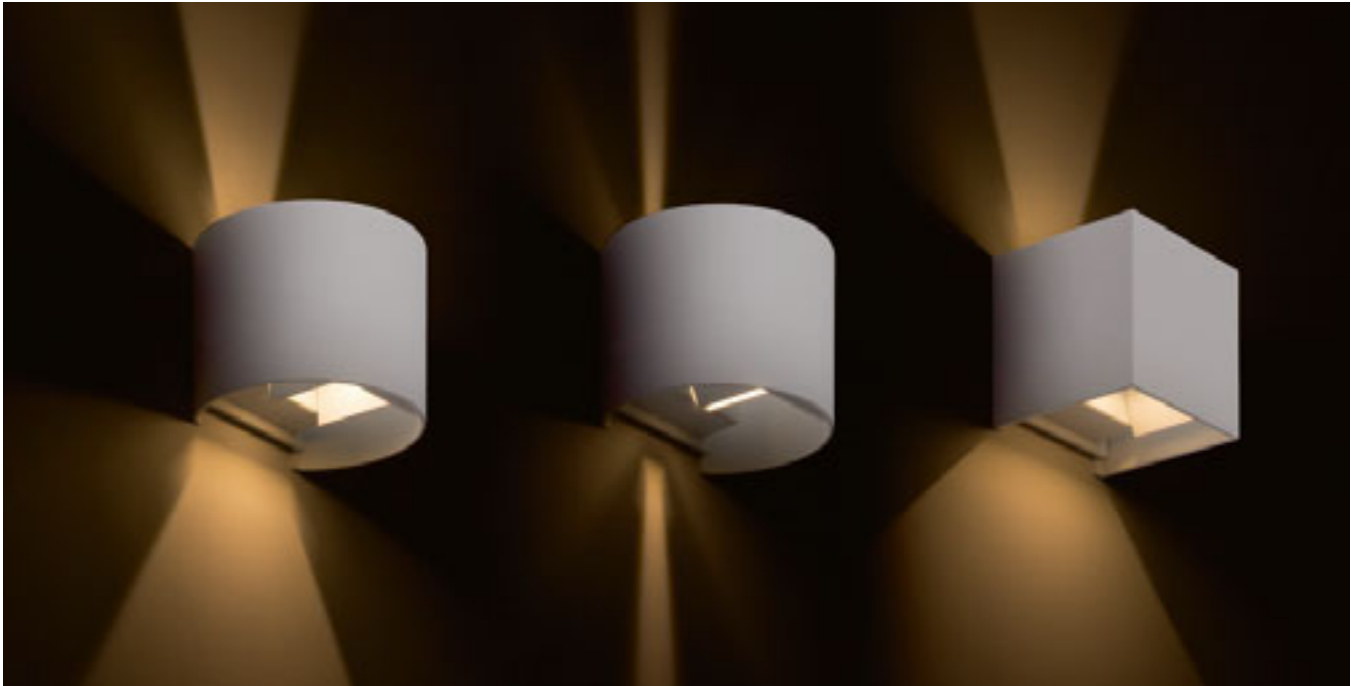

IP65



IP65

## TITO

Applique da parete a LED con illuminazione UP/DOWN, con fascio di luce regolabile. Dimmerazione TRIAC.

### TITO R DIMM DA PARETE

230 V LED 2x3 W 3000 K 500 lm Ra 80 IP65

R13736 bianco

€ 88

R13737 nero

€ 88

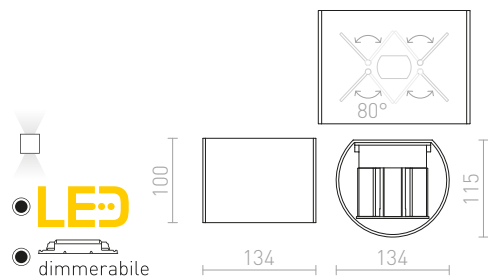

### TITO SQ DIMM DA PARETE

230 V LED 2x3 W 3000 K 500 lm Ra 80 IP65

R13738 bianco

€ 88

R13739 nero

€ 88

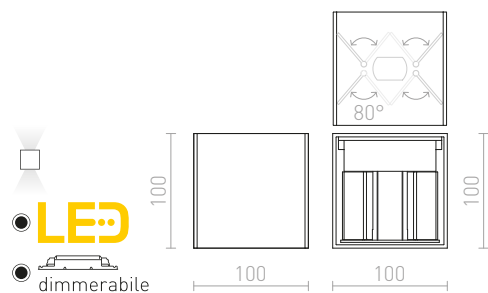



IP54

## CARRE

Appliche quadrata con LED integrato per illuminazione UP/DOWN, con possibilità di regolare il fascio luminoso.

### CARRE DA PARETE

230 V LED 2x3 W 3000 K 200 lm Ra 80 IP54

R12556 bianco

€ 88

R12557 grigio antracite

€ 88

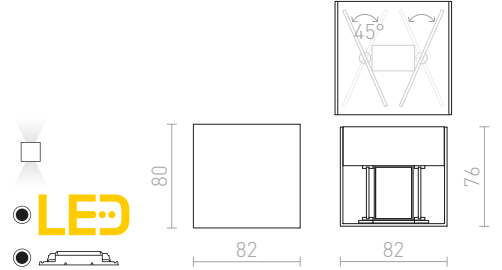

IP54

## TITO

Appliche da parete a LED con illuminazione UP/DOWN, con fascio di luce regolabile.

### TITO SQ DA PARETE

230 V LED 6 W 3000 K 500 lm Ra 80 IP54

R12601 alluminio spazzolato

€ 78

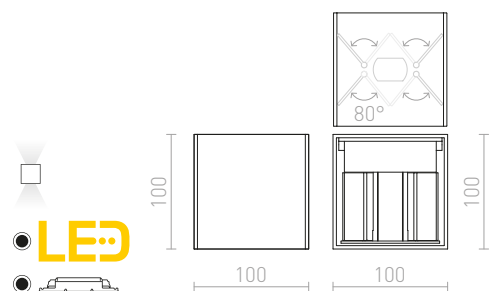



## DAFFY

Apparecchio arrotondato con LED integrato per illuminazione UP/DOWN.

### DAFFY DA PARETE

230 V LED 6 W 3000 K 780 lm Ra 80

R12592 bianco

€ 98

R12593 nero

€ 98

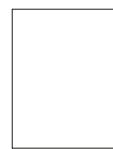

110





IP54



## MIDZACK

Apparecchio da parete arrotondato per illuminazione UP/DOWN con LED integrato.

### MIDZACK DA PARETE

230 V LED 2x3 W 3000 K 480 lm Ra 80 IP54

R12585 bianco

€ 88

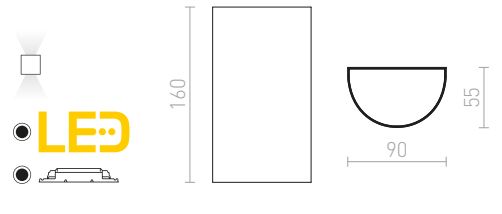

## BIARITZ

Apparecchio da parete circolare con LED integrato per illuminazione UP/DOWN.

### BIARITZ DA PARETE

230 V LED 5 W 3000 K 780 lm Ra 80

R12606 bianco

€ 68

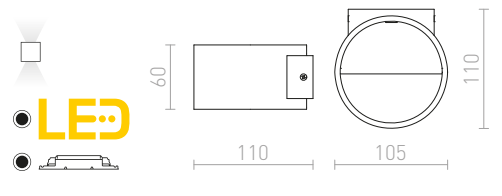

## TUBA

Lampada cilindrica in metallo con portalampada G9, per illuminazione UP/DOWN.

### TUBA W DA PARETE

230 V G9 33 W

R12739 bianco opaco

€ 48

R12740 nero opaco/oro

€ 48

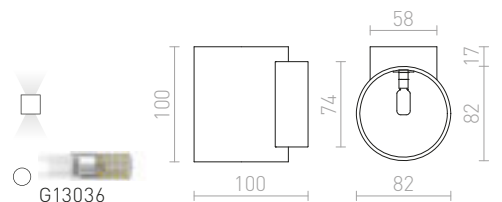



IP54

## MICO

Applique in alluminio pressofuso con riflettore non orientabile, per illuminazione unidirezionale.

**MICO I PARETE**  
230 V GU10 35 W IP54

**R10170** alluminio

€ 58

%



G11837

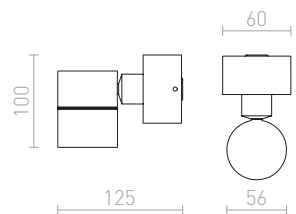



### MICO

Mini applique UP/DOWN in alluminio lucido per sorgenti luminose alogene.

#### MICO II DA PARETE

230 V G9 2x25 W

R10129 alluminio

€ 68 %

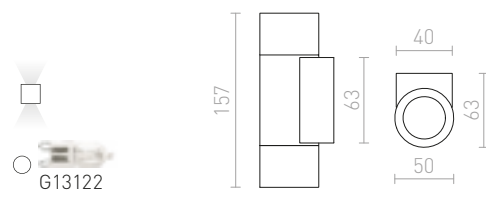

IP54

### MOIRE

Lampada da parete in alluminio naturale con coperture di vetro.

#### MOIRE I PARETE

230 V GU10 35 W IP54

R10133 alluminio

€ 48 %

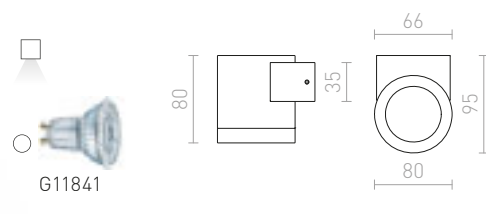

IP54

#### MOIRE II PARETE

230 V G9 25 W IP54

R10132 alluminio

€ 68 %

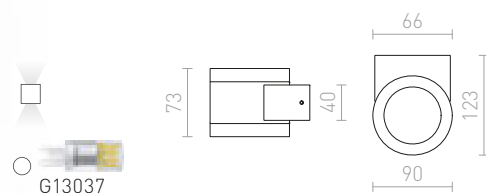

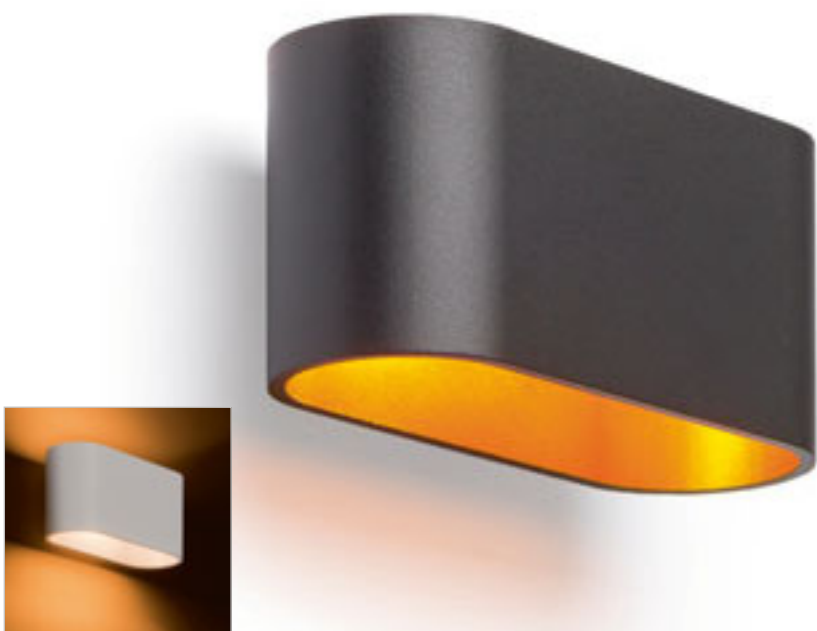

## MARIO

Lampada da parete ovale in metallo con illuminazione UP/DOWN ed portalampada G9.

### MARIO

230 V G9 33 W

**R12743** bianco opaco

€ 58

**R12744** nero opaco/oro

€ 68

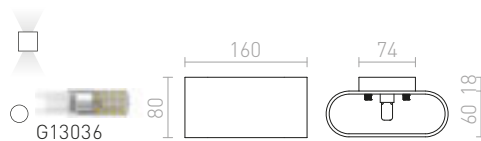

## ROZA

Apparecchio da parete arrotondato con LED integrato e illuminazione UP/DOWN.

### ROZA DA PARETE

230 V LED 6 W 3000 K 315 lm Ra 80

**R12575** bianco

€ 58

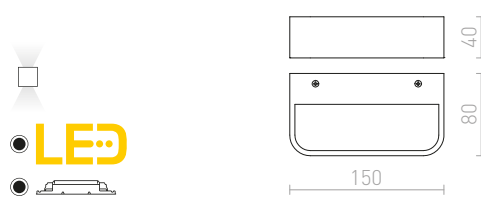

## NAXOS

Apparecchio da parete arcato con LED integrato per illuminazione UP/DOWN.

### NAXOS DA PARETE

230 V LED 6 W 3000 K 780 lm Ra 80

**R12590** bianco

€ 120 %

**R12591** metallo spazzolato

€ 120 %

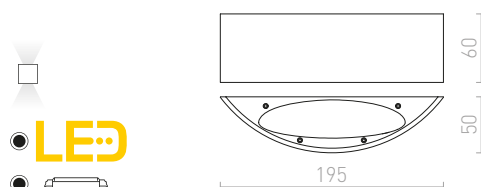



IP54

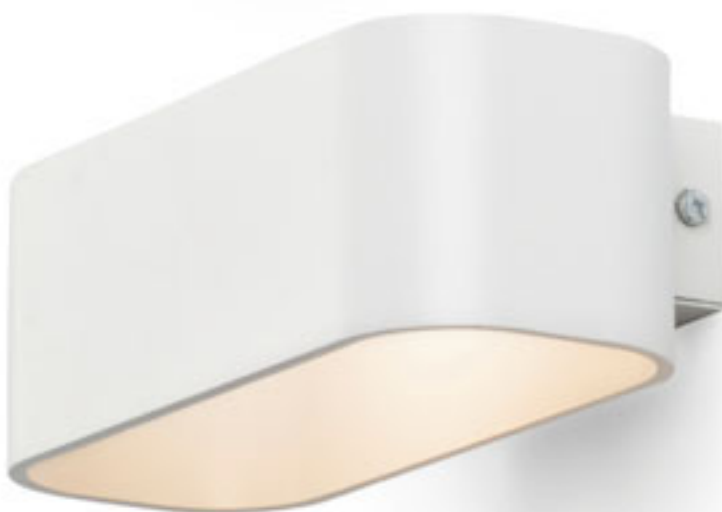

### TAPA

Applicare rettangolare UP/DOWN LED da esterno in metallo laccato.

#### TAPA DA PARETE

230 V LED 6 W 3000 K 277 lm Ra 80 IP54

R13562 bianco

€ 68

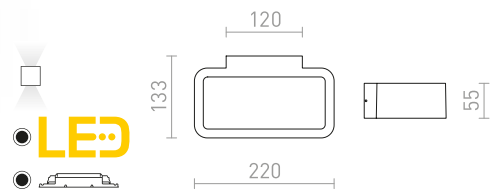

### REEM

Apparecchio da parete con LED integrato di alluminio laccato per illuminazione UP/DOWN.

#### REEM DA PARETE

230 V LED 4,5 W 3000 K 300 lm Ra 80

R10401 bianco

€ 98

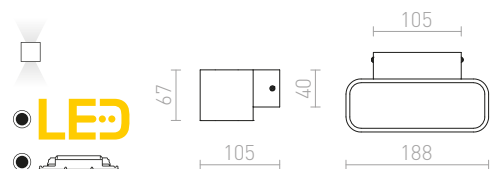





## TRIP

Lampada rettangolare da parete in metallo con illuminazione UP/DOWN ed portalampada G9.

### TRIP SQ DA PARETE

230 V G9 33 W

R12741 bianco opaco

€ 38

R12742 nero opaco/oro

€ 48

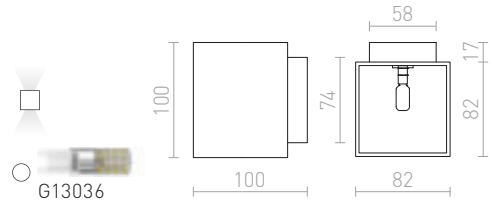

## DIDO

Apparecchio rettangolare di alluminio laccato bianco con potente LED integrato per illuminazione UP/DOWN.

### DIDO DA PARETE

230 V/500 mA LED 4,5 W 3000 K 250 lm Ra 80

R10400 bianco

€ 98

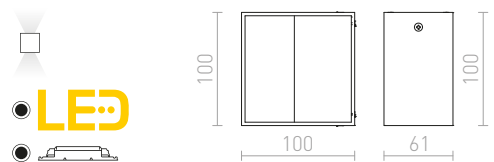

## ESSEX

Lampada da parete quadrata in metallo per illuminazione UP/DOWN con portalampada G9.

### ESSEX DA PARETE

230 V G9 33 W

R12679 bianco opaco

€ 35

R12680 alluminio spazzolato

€ 35

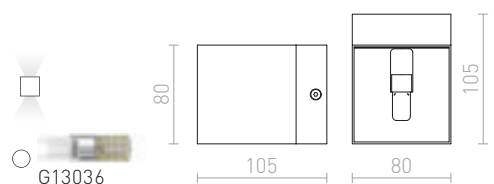



## KORSO

Apparecchio da parete con LED integrato per uso esterno e interno. Realizzato in alluminio spazzolato con finitura naturale o nero anodizzato.

### KORSO II DA PARETE

230 V LED 2x3 W  $\angle 120^\circ$  3000 K 780 lm Ra 80 IP54

R12831 alluminio spazzolato

€ 68 %

R12832 nero anodizzato

€ 68 %

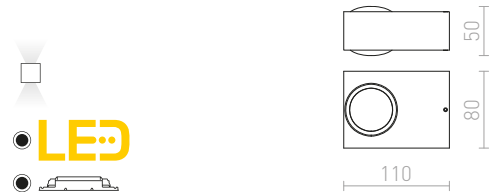

## PEKKO

Applique quadrata da esterno con LED integrato per illuminazione unidirezionale.

### PEKKO DA PARETE

230 V LED 3 W  $\angle 67^\circ$  3000 K 86 lm Ra 80 IP54

R12552 bianco

€ 78

R12553 nero

€ 78

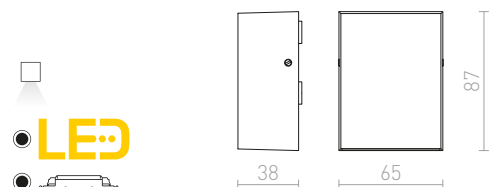

IP54



## ONYX

Apparecchio cubico da parete con LED integrato, angoli arrotondati e superficie di riflessione strutturata per illuminazione UP/DOWN.

### ONYX DA PARETE

230 V LED 5 W 3000 K 500 lm Ra 80

R12598 bianco

€ 68

R12599 nero

€ 68

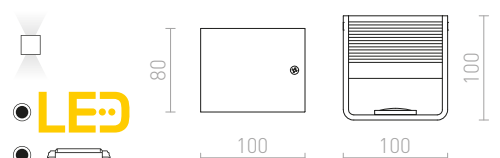

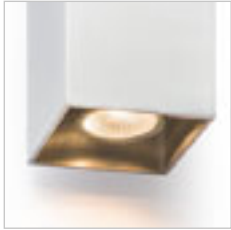

## AGATE

Applique quadrata in metallo, con illuminazione UP/DOWN per due sorgenti luminose di riflettore con portalampana GU10.

### AGATE II DA PARETE

230 V GU10 2x35 W

R12677 bianco opaco

€ 68

R12678 alluminio spazzolato

€ 48

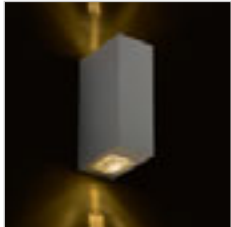
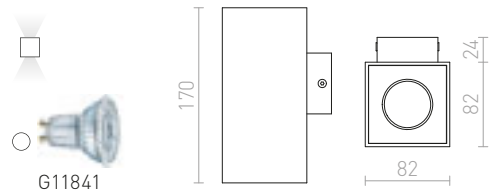

IP54

## NICK

Applique a LED con illuminazione UP/DOWN per uso esterno ed interno.

### NICK II DA PARETE

230 V LED 2x3 W  $\angle 10^\circ$  3000 K 780 lm Ra 80 IP54

R12827 alluminio spazzolato

€ 68

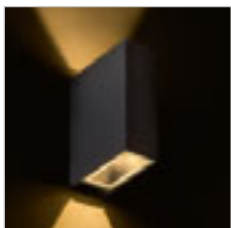
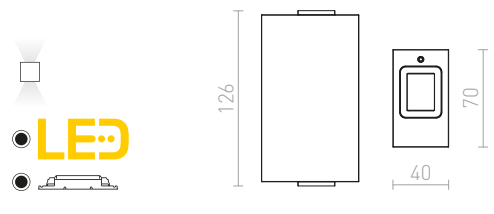

IP54

## UKKO

Applique quadrata da esterno con LED integrato per illuminazione UP/DOWN.

### UKKO DA PARETE

230 V LED 2x3 W  $\angle 55^\circ$  3000 K 180 lm Ra 80 IP54

R12555 nero

€ 120

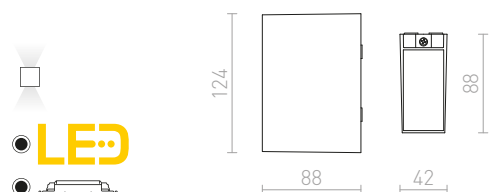



## DESMOND

Appliche da esterno in alluminio, con illuminazione UP/DOWN, compatibile con due lampadine LED con portalampada GU10.

### DESMOND II DA PARETE

230 V GU10 2x35 W IP44

**R13609** bianco

€ 68

**R13610** grigio argento

€ 68

**R13611** grigio antracite

€ 68

IP44



G11841



205



92



83

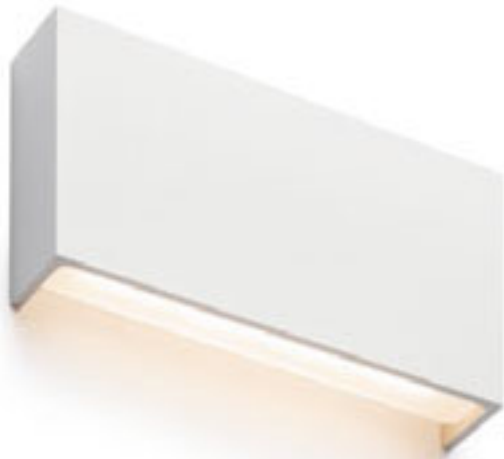

IP54

## TORINO

Applique rettangolare con LED integrato con illuminazione UP/DOWN.

### TORINO DA PARETE

230 V LED 2x5 W 3000 K 550 lm Ra 80 IP54

R12573 bianco

€ 129

R12574 nero

€ 129



LED

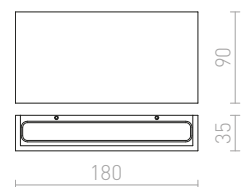





## LEA

Apparecchio rettangolare da parete con LED integrato per illuminazione UP/DOWN.

### LEA DA PARETE

230 V LED 6 W 3000 K 650 lm Ra 80

R12587 bianco

€ 68 %

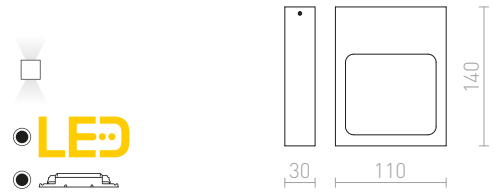

## NEMAN

Apparecchio rettangolare da parete con LED integrato per illuminazione UP/DOWN.

### NEMAN DA PARETE

230 V LED 10 W 3000 K 1300 lm Ra 80

R12595 nero

€ 120

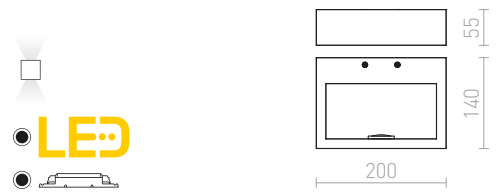

## CHLOE

Applique rettangolare a LED in acciaio inossidabile, per illuminazione indiretta. Adatta sia per esterni che per interni.

### CHLOE DA PARETE

230 V LED 9 W 3000 K 800 lm Ra 80 IP65

R11752 acciaio inossidabile

€ 120

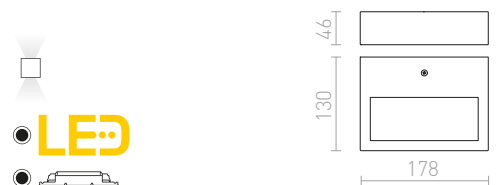

IP65

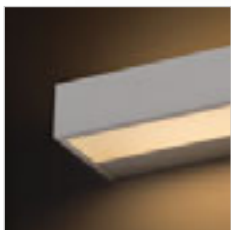

## PRIO LED

Apparecchio da parete in alluminio a LED integrato, per illuminazione UP/DOWN. Disponibile in due colori. Non usabile come mensola!

### PRIO LED 62 DA PARETE

230 V LED 33 W 3000 K 720 lm Ra 80

R12091 bianco

€ 178

%

R12092 alluminio spazzolato

€ 178

%



LED





IP65

## TWIST

Applique da esterno a LED in alluminio, con possibilità di regolare l'illuminazione in basso o in direzione opposta come illuminazione indiretta.

### TWIST DA PARETE

230 V LED 12 W 3000 K 980 lm Ra 80 IP65

R13615 bianco

€ 98

R13616 grigio antracite

€ 98

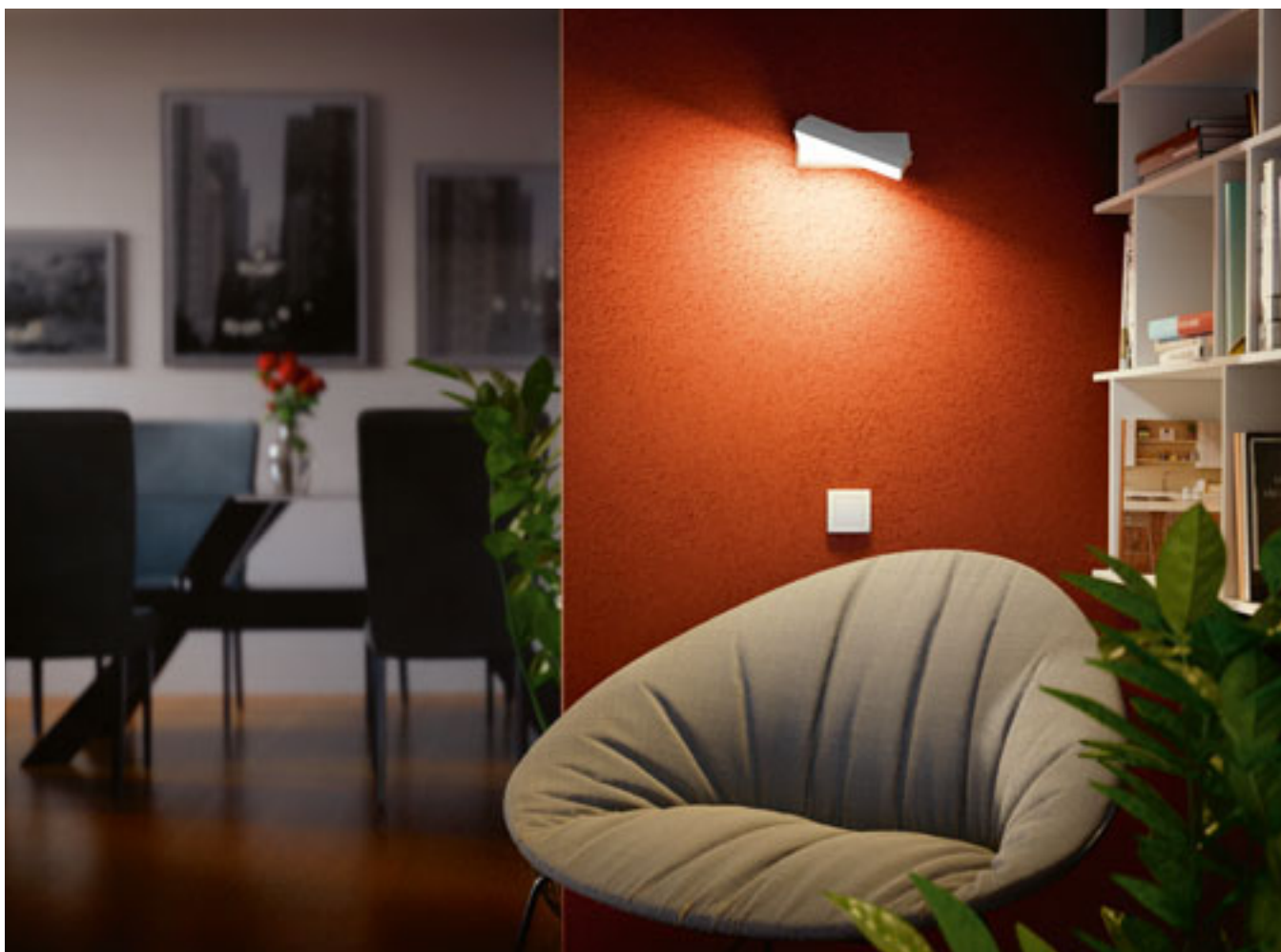
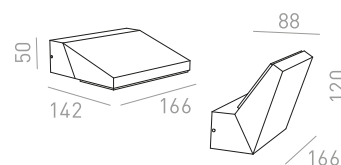



## SWING

Apparecchio lineare con LED integrato adatto per illuminare quadri.

### SWING SOPRA QUADRO

230 V LED 8W 3000 K 750 lm Ra 80

R12954 cromo

€ 138

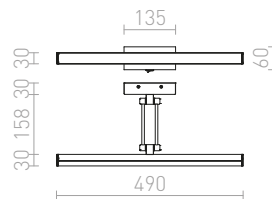

IP44

## SWAY

Applique lineare con LED integrato e funzione inclinabile, adatta sopra quadri o specchi.

### SWAY PER BAGNO

230 V LED 12W 3000 K 1060 lm Ra 80 IP44

R12951 cromo

€ 120

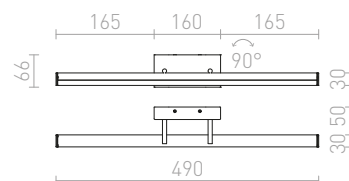

IP44

## PANON

Applique lineare su braccio fisso con LED integrato per illuminazione verso il basso. Adatta per ambienti umidi.

### PANON LONG DA PARETE

230 V LED 12W 3000 K 900 lm Ra 80 IP44

R12950 cromo

€ 120

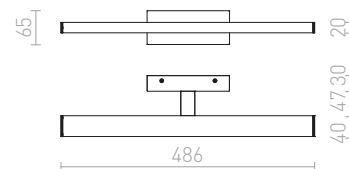
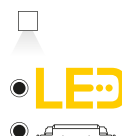







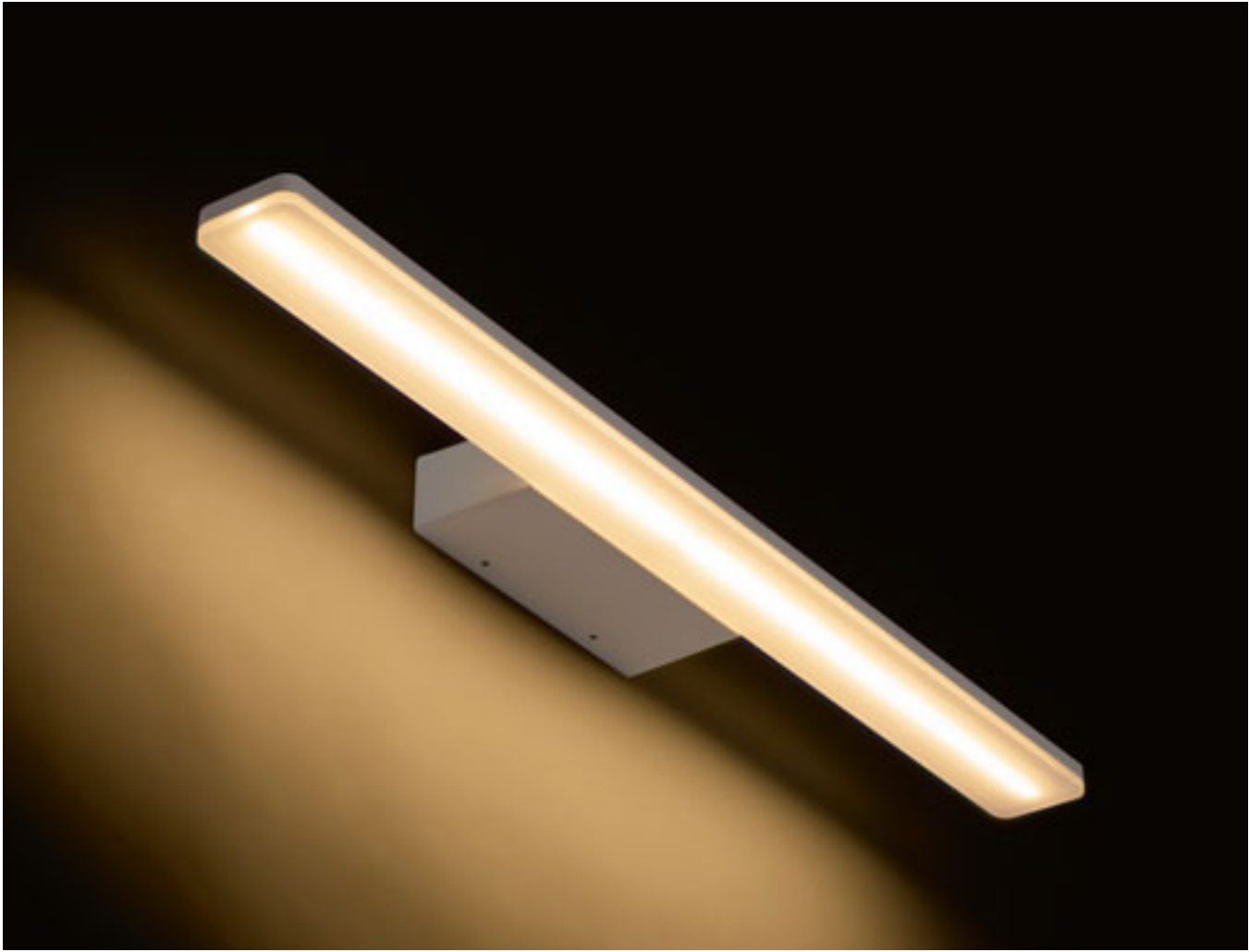

IP44



## MAREA

Lampada da specchio lineare a luci LED orientate verso il basso. Adatta per ambienti umidi.

### MAREA 60 DA PARETE

230 V LED 18 W 3000 K 1954 lm Ra 80 IP44

R13554 bianco

€ 188

R13852 nero

€ 188

NEW

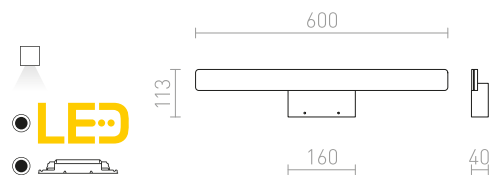

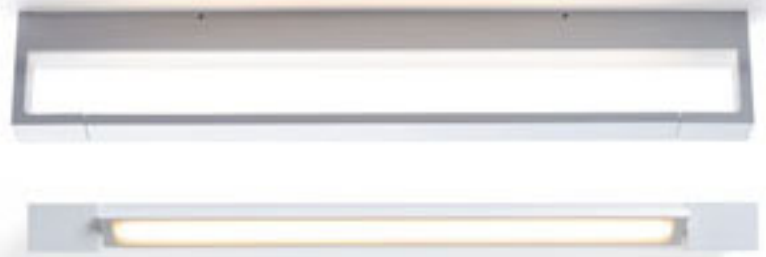

IP44

### IMPERISO

Lampada da specchio lineare a LED con parte anteriore orientabile in asse orizzontale. Adatta per ambienti umidi.

#### IMPERISO 60

230 V LED 18 W 3000 K 1769 lm Ra 80 IP44

R13555 bianco

€ 248

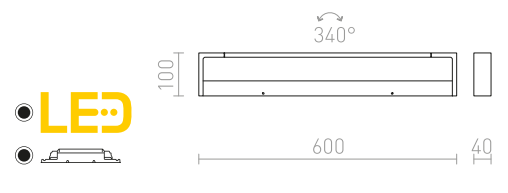

IP54

### LUISA

Lampada da specchio lineare a luci LED orientate verso il basso. Adatta per ambienti umidi.

#### LUISA 60 DA PARETE

230 V LED 12 W 3000 K 1138 lm Ra 80 IP54

R13735 bianco

€ 150

R13853 nero

€ 150

NEW

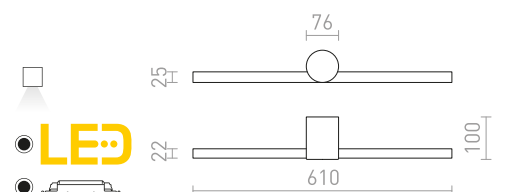



IP44



IP44



### FLORIO

Applique per bagno con LED integrato e presa per dispositivi a basso consumo fino a 100W.

#### FLORIO 49

230 V LED 8 W 3000 K 640 lm Ra 80 IP44

R12903 bianco

€ 88

R12904 cromo

€ 98



LED

55



480

65



IP44



IP44



### CORAZON

Applique lineare con LED integrato adatta per ambienti umidi.

#### CORAZON 60

230 V LED 15 W 3000 K 1200 lm Ra 80 IP44

R12901 cromo

€ 78



LED

51



600

70

#### CORAZON 90

230 V LED 20 W 3000 K 1600 lm Ra 80 IP44

R12902 cromo

€ 120



LED

51



900

70





## TICO

Apparecchio unidirezionale da parete in alluminio robusto. Fascio unico.

### TICO I DA PARETE

230 V LED 3W 3000 K 190lm Ra 80

R10178 alluminio

€ 38 %

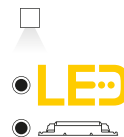

60

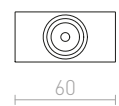

30

60





IP54

## AMBER

Applique circolare con LED integrato utilizzabile come luce segnapasso. L'incasso non è necessario.

### AMBER DA PARETE

230 V LED 3 W 3000 K 130 lm Ra 80

R12610 grigio

€ 48

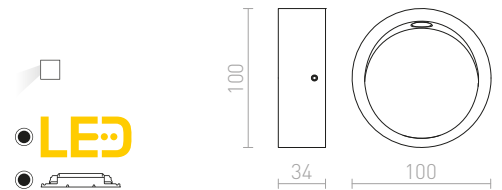

## AQUILA

Applique con LED integrato per illuminazione di orientamento (illuminazione segnapasso) di marciapiedi, scale o terrazze. Per uso esterno e interno senza necessità d'incasso. Solo luce verso il basso.

### AQUILA SQ DA PARETE

230 V LED 6 W 3000 K 200 lm Ra 80 IP54

R12542 bianco

€ 88

R12544 grigio antracite

€ 88

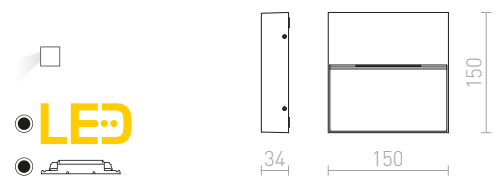

IP54

### AQUILA RC DA PARETE

230 V LED 6 W 3000 K 200 lm Ra 80 IP54

R12545 bianco

€ 88

R12547 grigio antracite

€ 98

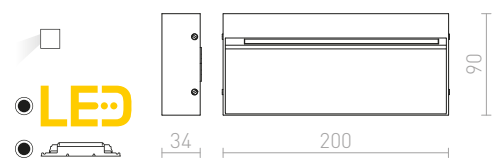

IP54

### AQUILA R DA PARETE

230 V LED 6 W 3000 K 200 lm Ra 80 IP54

R12539 bianco

€ 88

R12540 grigio

€ 78

R12541 grigio antracite

€ 88

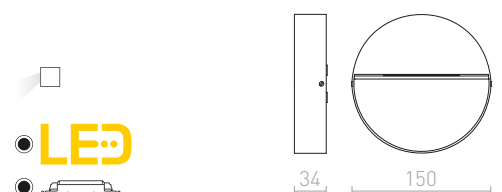

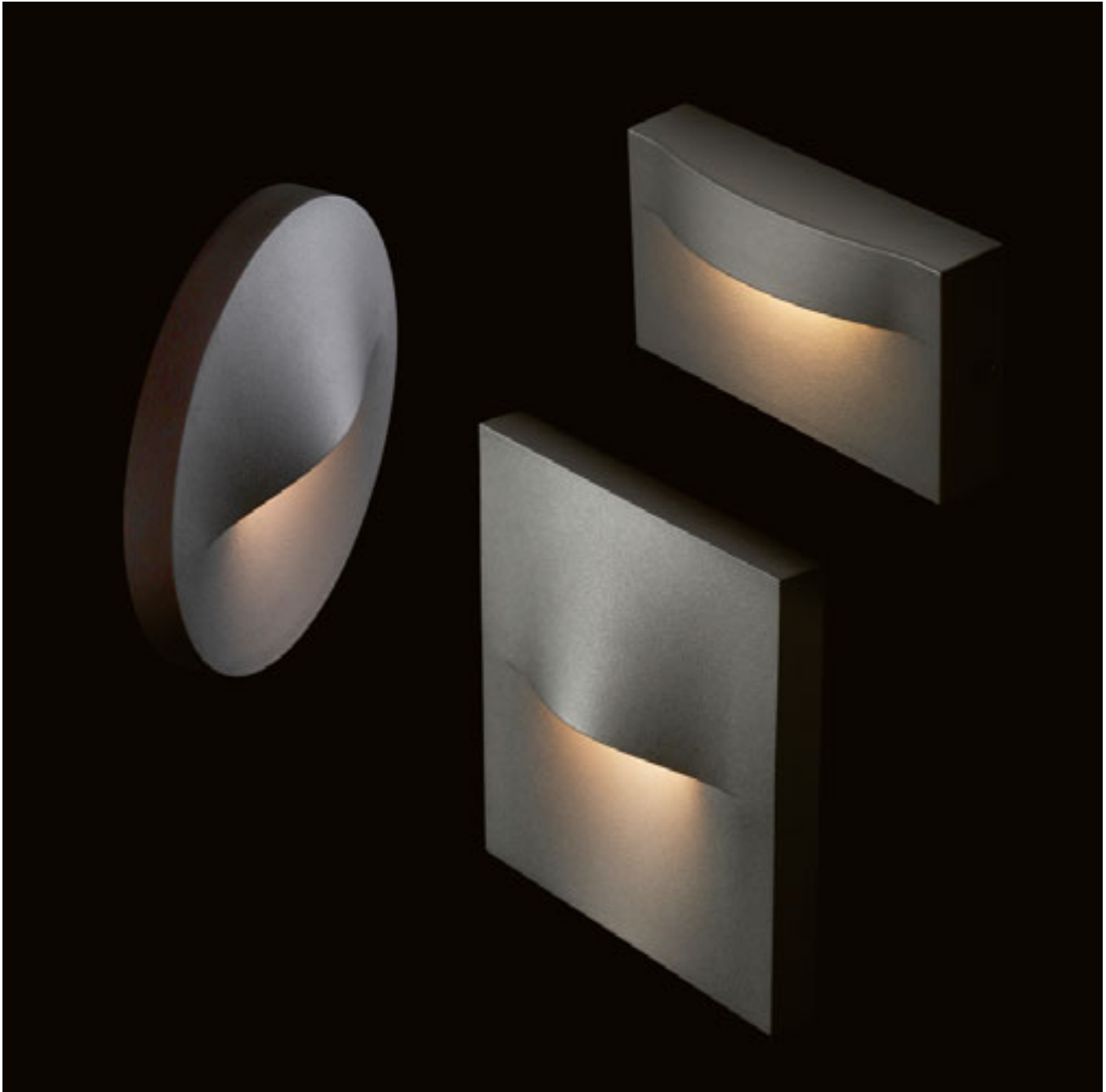

IP65



## BOBO

Luce a LED da esterno in alluminio a plafone per l'illuminazione di orientamento di camminamenti e scale senza necessità d'incasso.

### BOBO R DA PARETE

230 V LED 3 W 3000 K 212 lm Ra 80 IP65

R13933 grigio antracite

€ 48 **NEW**

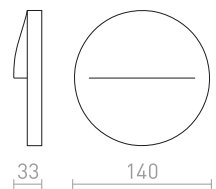
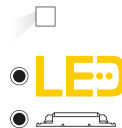

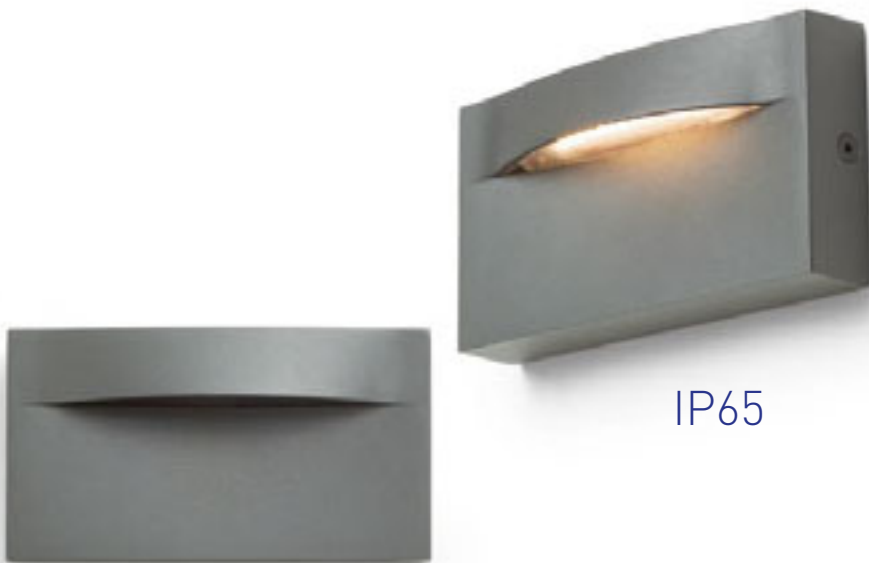

IP65

### BOBO

Luce a LED da esterno in alluminio a plafone per l'illuminazione di orientamento di camminamenti e scale senza necessità d'incasso.

#### BOBO RC DA PARETE

230V LED 8W 3000K 640lm Ra80 IP65

R13934 grigio antracite

€ 58 **NEW**

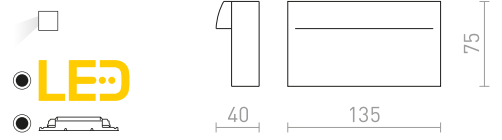

IP65

### BOBO

Luce a LED da esterno in alluminio a plafone per l'illuminazione di orientamento di camminamenti e scale senza necessità d'incasso.

#### BOBO SQ DA PARETE

230V LED 3W 3000K 135lm Ra80 IP65

R13935 grigio antracite

€ 48 **NEW**

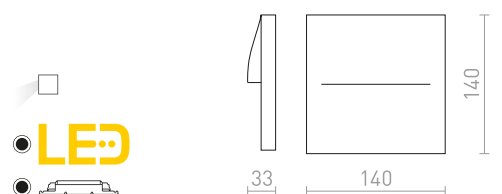



## FARETTI

|                     |         |
|---------------------|---------|
| PER BAGNO           | 272-275 |
| PER CAMERA DA LETTO | 276-285 |
| SET                 | 286-303 |
| A COLLO DI CIGNO    | 304-309 |
| INCLINABILI         | 310-317 |



## FARETTO PER BAGNO



**LINN I**  
272-273



**LINN III**  
272-273



**VALTO I**  
272-273

272-275



**VALTO III**  
272-273



**BOLLY III**  
272-273



**DUBLIN I**  
274-275



**DUBLIN II**  
274-275



**DUBLIN III**  
274-275



**DUBLIN IV**  
274-275

## FARETTO PER CAMERA DA LETTO



**VERSA**  
276-277



**VERSINA**  
276-277



**TAINA**  
276-277

276-285



**PERTH**  
276-277



**CHOUPETTE**  
278-279



**ARAQ**  
278-279



**HAREN**  
278-279



**ROSTAM**  
278-279



**VIPER WL**  
280-281



**TIARA**  
280-281



**FADO I**  
280-281



**MIG**  
280-281



**TAPIRO I SQ**  
280-281



**AMADEUS I**  
282-283



**STIG**  
282-283



**THALIA**  
282-283



**VOLTERA USB**  
284-285



**SIENA**  
284-285



**ELISEO**  
284-285

**FARETTO SET**



**BOGARD I**  
286-287



**BOGARD II**  
286-287



**BOGARD III**  
286-287

286-303



**KENNY I**  
288-289



**KENNY II**  
288-289



**KENNY III**  
288-289



**KENNY IV**  
288-289



**KENNY**  
288-289



**DUDE R**  
290-291



**DUDE SQ**  
290-291



**DUDE**  
290-291



**DUDE II**  
290-291



**DUGME I**  
292-293



**DUGME II**  
292-293



**DUGME III**  
292-293



**TRICA I**  
294-295



**TRICA II**  
294-295



**TRICA III**  
294-295



**KELLY LED I**  
296-297



**KELLY LED II**  
296-297



**KELLY LED III**  
296-297



**KELLY LED**  
296-297



**KELLY LED I**  
298-299



**KELLY LED II**  
298-299



**KELLY LED III**  
298-299



**ELISEO**  
300-301



**ELISEO II**  
300-301



**GLOSSY**  
302-303



**GLOSSY I**  
302-303



**GLOSSY III**  
302-303



**ROSITA I**  
302-303



**ROSITA II**  
302-303

## FARETTO A COLLO DI CIGNO

304-309



**AIM**  
304-305



**FRISCO W**  
304-305



**EKE**  
304-305



**POINT**  
306-307



**VERSA**  
306-307



**SHOW**  
306-307



**BOB**  
306-307



**KAYA**  
308-309



**FLAP**  
308-309



**VALE**  
308-309

## FARETTO INCLINABILI



**CELEIA**  
310-311



**AGNETA**  
310-311



**BAROQUE**  
310-311

310-317



**JOLI I**  
310-311



**BELENOS**  
312-313



**BOGARD**  
312-313



**BOGARD TWIN**  
312-313



**OPTIMUS**  
312-313



**DARIO**  
314-315



**DARIO**  
314-315



**PIXIE**  
314-315



**ORIT**  
314-315



**CASSIE**  
316-317



**BUGSY I**  
316-317



**REDO**  
316-317



**MARVEL II**  
316-317



IP44

## BOLLY

Apparecchio con vetri opalini su base cromata. Adatto per ambienti umidi.

### BOLLY III APPLIQUE/PLAFONIERA

230 V G9 LED 3x3 W IP44

R13691 vetro opalino/cromo

€ 129

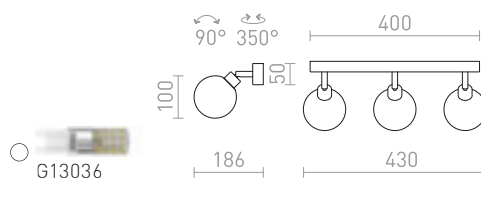

IP44

## LINN

Plafoniera/applique con vetro opalino e con base cromata. Adatta per ambienti umidi.

### LINN I DA PARETE

230 V G9 LED 3 W IP44

R13695 vetro opalino/cromo

€ 48

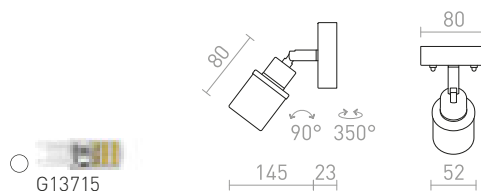

### LINN III APPLIQUE/PLAFONIERA

230 V G9 LED 3x3 W IP44

R13703 vetro opalino/cromo

€ 120

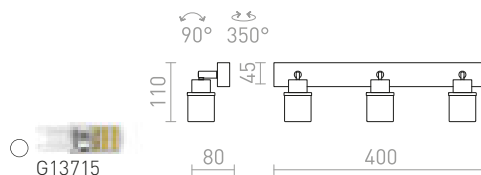





### VALTO

Appliche o plafoniera con riflettori reclinabili per sorgenti luminosi LED con portalampana GU10. Adatta per ambienti umidi.

#### VALTO I DA PARETE

230 V GU10 LED 5 W IP44

R13696 cromo

€ 48



G11837

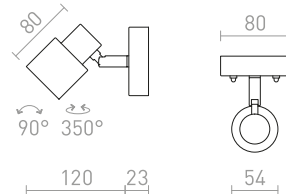

#### VALTO III APPLIQUE/PLAFONIERA

230 V GU10 LED 3x5 W IP44

R13704 cromo

€ 88



G11837

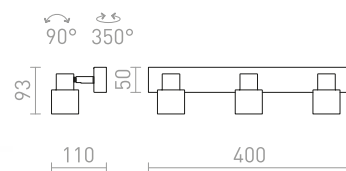





IP44



IP44



IP44



IP44

## DUBLIN

Faretto cromato adatto per ambienti umidi.

### DUBLIN I APPLIQUE/PLAFONIERA

230 V GU10 9 W IP44

R13377 cromo

€ 48

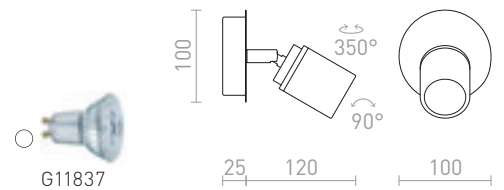

### DUBLIN II APPLIQUE/PLAFONIERA

230 V GU10 2x9 W IP44

R13378 cromo

€ 78

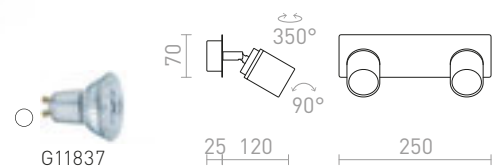

### DUBLIN III APPLIQUE/PLAFONIERA

230 V GU10 3x9 W IP44

R13379 cromo

€ 98

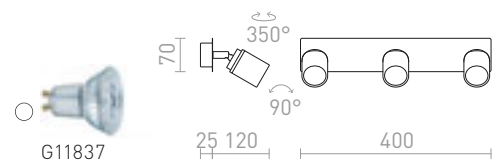

### DUBLIN IV APPLIQUE/PLAFONIERA

230 V GU10 4x9 W IP44

R13380 cromo

€ 129

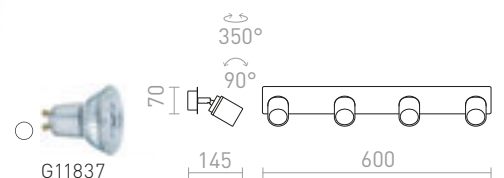



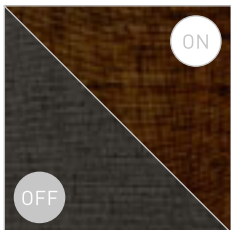
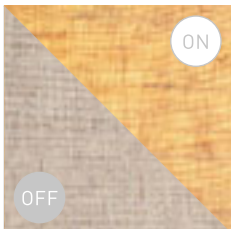

## PERTH

Applique con paralume quadrato tessile, con collo flessibile e con proiettore a diodo LED. Apparecchio con due sorgenti luminose che possono essere controllati autonomamente dall'interruttore girevole posizionato sulla base quadrata dell'apparecchio.

### PERTH DA PARETE CON FARETTO A LED

230 V E14 LED 15 W+3 W  $\angle 30^\circ$  3000 K 150 lm Ra 80

**R13661** beige/bianco/cromo

€ 178

**R13662** nero/nero/cromo

€ 178



G13572

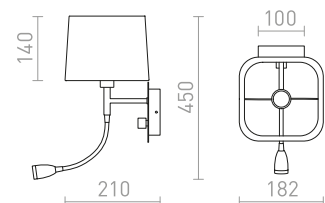



## VERSA

Applique con paralume di tessuto. Collo flessibile  
addizionale con riflettore a diodi LED. Due sorgenti  
luminose possono essere controllate separatamente  
tramite interruttori a levetta posizionati sulla base.

### VERSA DA PARETE CON PARALUME

230 V E27 LED 42 W+3 W  $\angle 40^\circ$  3000 K 240 lm Ra 80

**R10580** bianco/nichel opaco

€ 178

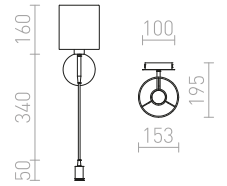
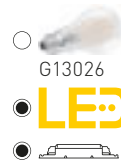

## VERSINA

Lampada da parete con paralume in tessuto,  
completata da riflettore a diodo LED su collo di cigno.  
Due sorgenti luminose possono essere controllate  
separatamente tramite interruttori sulla base rotonda  
dell'apparecchio.

### VERSINA CON PARALUME

230 V E27 LED 28 W+3 W  $\angle 25^\circ$  3000 K 180 lm Ra 80

**R12955** bianco/cromo

€ 129

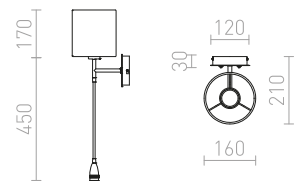

## TAINA

Applique con paralume in tessuto completata  
da riflettore LED su collo di cigno. Due sorgenti  
luminose possono essere controllate separatamente  
dagli interruttori sulla base quadrata dell'apparecchio.

### TAINA CON PARALUME

230 V E27 LED 28 W+3 W  $\angle 25^\circ$  3000 K 180 lm Ra 80

**R12956** bianco/nichel opaco

€ 138

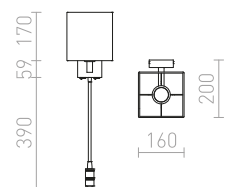





## CHOUPETTE

Lampada da parete in tessuto con possibilità di spostamento su consolle di legno. Il cavo di alimentazione termina con la spina per la presa.

### CHOUPETTE SCORREVOLE DA PARETE

230 V E27 15 W

R13649 grigio nerastro/tessuto/legno

€ 215

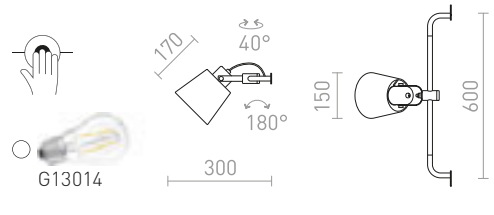

## ROSTAM

Applique a LED da parete con mensole per cellulare e porta USB integrata. Faretto LED su collo flessibile e luce indiretta sono regolabili autonomamente da due interruttori.

### ROSTAM DA PARETE CON USB

230 V LED 2x3W 3000 K 350 lm Ra 80

R13571 nero

€ 150

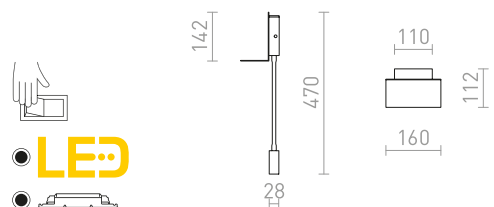



## ARAQ

Lampada da parete con portalampana e braccio in ottone su base laccata nera. Adatto per lampadina decorativa con attacco E27.

### ARAQ DA PARETE

230 V E27 42 W

R13890 ottone spazzolato/nero

€ 32

NEW

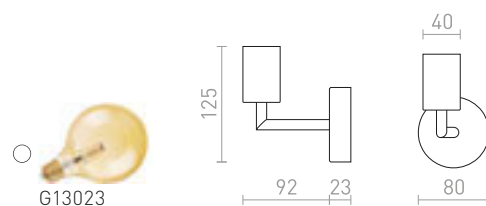

## HAREN

Riflettore robusto con portalampana E27, adatto per uso con sorgente luminosa faretto.

### HAREN APPLIQUE/PLAFONIERA

230 V E27 15 W

R13612 rame/nero

€ 58

R13613 nero

€ 48

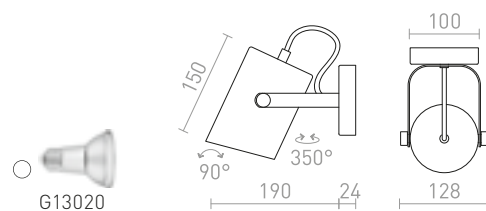



## VIPER

Applique di design con particolari in cromo. Riflettore LED nero e cavo in tessuto rosso.

### VIPER WL

230 V LED 3 W  $\angle 60^\circ$  3000 K 100 lm Ra 80

R12461 nero/cromo

€ 88 %

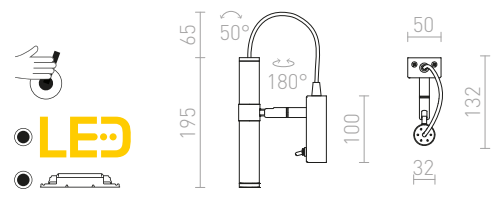

## FADO

Applique con design quadrato e riflettore LED orientabile.

### FADO I DA PARETE

230 V LED 3 W  $\angle 45^\circ$  4000 K 110 lm Ra 80

R12473 nero

€ 129

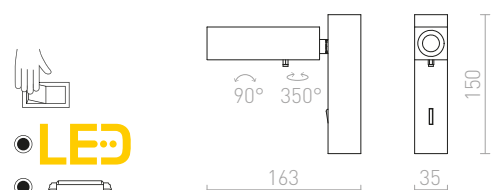

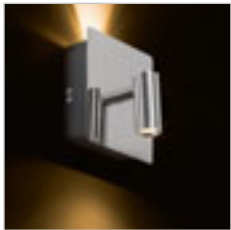

## TIARA

Applique con due sorgenti luminose a LED integrate completato con illuminazione di sopra indiretta. Due sorgenti luminose regolabili separatamente tramite interruttori posti sulla base dell'apparecchio.

### TIARA DA PARETE

230 V LED 2x3 W  $\angle 25^\circ$  3000 K 300 lm Ra 80

R12957 cromo

€ 68

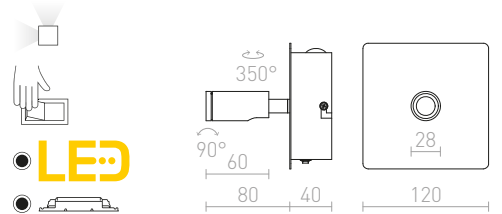

## TAPIO

Applique a LED su base rettangolare.

### TAPIO I SQ DA PARETE

230 V LED 4,5 W 3000 K 350 lm Ra 80

R13423 nero

€ 88

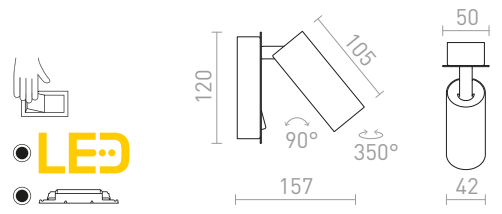

## MIG

Applique faretto a LED elegante con interruttore, adatta per uso in camera da letto. Con l'aiuto di un manicotto posizionato sulla base è possibile attaccare il cavo nella presa. Il cavo non fa parte della confezione.

### MIG DA PARETE

230 V LED 3 W  $\angle 30^\circ$  3000 K 150 lm Ra 80

R13644 bianco

€ 78

R13645 nero

€ 78

R13646 nichel opaco

€ 68

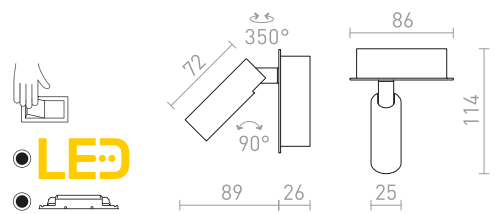



## AMADEUS

Applique a LED integrato e interruttore su base.  
Apparecchio orientabile su asse orizzontale di lato.

### AMADEUS I DA PARETE

230 V LED 6 W 3000 K 530 lm Ra 80

R12476 bianco

€ 120

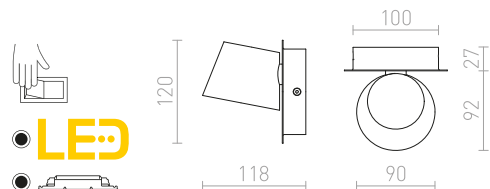





## THALIA

Appliche a LED con riflettore completato da un'illuminazione indiretta. L'apparecchio ha due sorgenti luminose che possono essere regolate separatamente da interruttori situati sulla base dell'apparecchio.

### THALIA DA PARETE

230 V LED 6 W + 3 W 3000 K 480 lm Ra 80

R13765 nero/acrilico satinato

€ 138 **NEW**

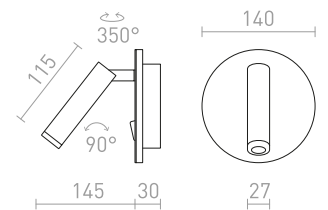
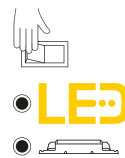

## STIG

Elegante applique a LED con interruttore a levetta.

### STIG DA PARETE

230 V LED 5,6 W  $\angle 34^\circ$  3000 K 404 lm Ra 80

R13941 nero

€ 98 **NEW**

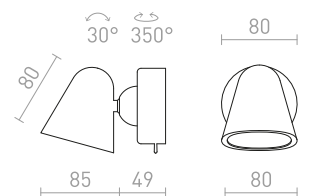



## VOLTERA

Applique laccata con riflettore inclinabile, adatto per sorgenti luminose con portalampada GU10. L'apparecchio è dotato di una porta USB integrata nella base, adatta a ricaricare, ad esempio, un telefono.

### VOLTERA USB DA PARETE

230 V GU10 50 W

**R13763** bianco

€ 129 **NEW**

**R13764** nero

€ 129 **NEW**

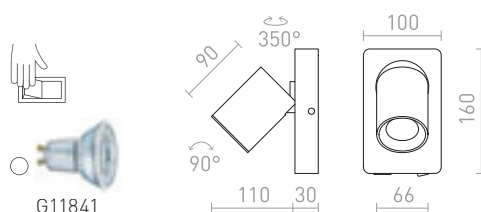

## ELISEO

Lampada da parete a LED con riflettore a ciotola rotante e diffusore bianco latte.

### ELISEO DA PARETE

230 V LED 5 W 3000 K 320 lm Ra 80

**R13914** bianco

€ 88 **NEW**

**R13915** nero

€ 88 **NEW**

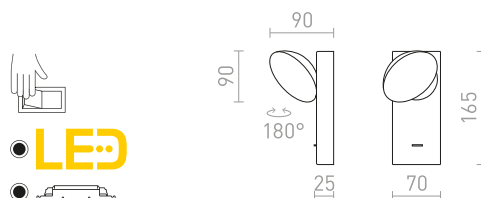



## SIENA

Apparecchio da parete laccato con riflettore inclinabile per sorgenti luminose con portalampana GU10. L'interruttore è posizionato sulla base dell'apparecchio.

### SIENA DA PARETE

230 V GU10 50 W

**R13761** bianco

€ 88 NEW

**R13762** nero

€ 88 NEW



G11841

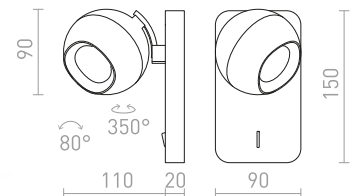



## BOGARD

Faretti da parete orientabili con LED integrato.

### BOGARD I DA PARETE

230 V LED 5W  $\angle 40^\circ$  3000 K 496 lm Ra 80

R12502 nichel opaco

€ 58 %

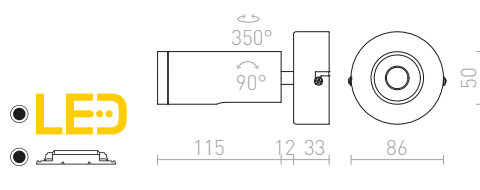

### BOGARD II DA PARETE

230 V LED 2x5 W  $\angle 40^\circ$  3000 K 700 lm Ra 80

R12503 nero opaco

€ 98 %

R12504 nichel opaco

€ 48 %

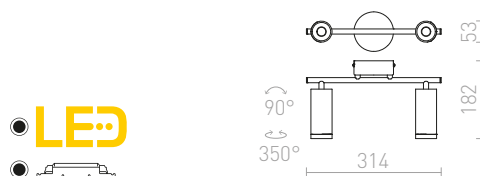

### BOGARD III DA PARETE

230 V LED 3x5 W  $\angle 40^\circ$  3000 K 1050 lm Ra 80

R12505 nero opaco

€ 120 %

R12506 nichel opaco

€ 68 %

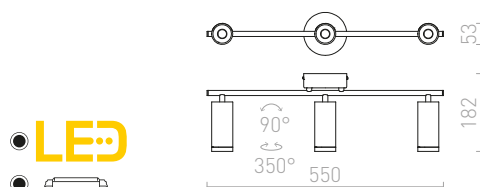









## KENNY

Serie elegante di faretti per sorgenti luminose con portalamпада GU10. Possibilità di modificare aspetto con anelli colorati intercambiabili (opzionale).

### KENNY I APPLIQUE/PLAFONIERA

230 V GU10 35 W

**R12912** bianco/nero € 58

**R12913** alluminio spazzolato/nero € 58

**R12914** nero/oro € 58

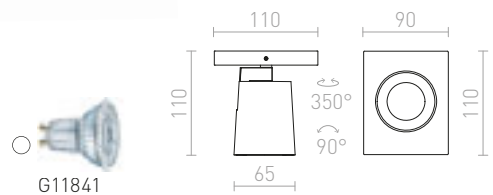

### KENNY II APPLIQUE/PLAFONIERA

230 V GU10 2x35 W

**R12915** bianco/nero € 120

**R12916** alluminio spazzolato/nero € 120

**R12917** nero/oro € 120

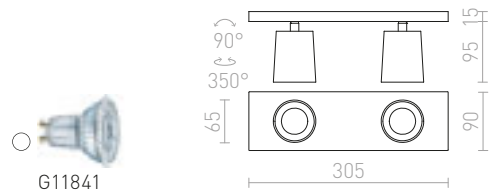

### KENNY III APPLIQUE/PLAFONIERA

230 V GU10 3x35 W

**R12918** bianco/nero € 158

**R12919** alluminio spazzolato/nero € 150

**R12920** nero/oro € 158

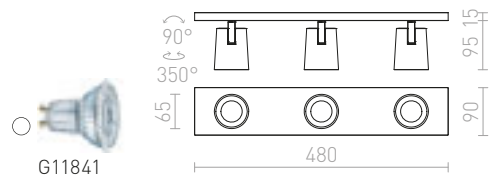

### KENNY IV DA SOFFITTO

230 V GU10 4x35 W

**R12921** bianco/nero € 188

**R12922** alluminio spazzolato/nero € 178

**R12923** nero/oro € 188

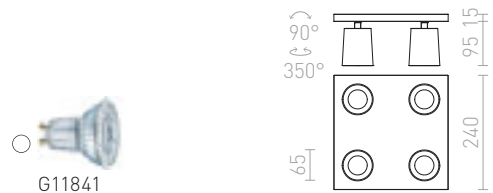



## KENNY

Anello di ricambio opzionale per serie faretto Kenny.  
Cambio di colore semplice.

### KENNY ANELLO DECORATIVO

|               |        |
|---------------|--------|
| R12924 bianco | € 3.60 |
| R12925 oro    | € 3.60 |
| R12926 nero   | € 3.60 |

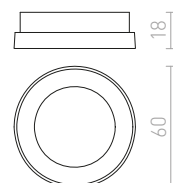



## DUDE

Plafoniera/applique per sorgente luminosa a LED con attacco GU10.

### DUDE SQ APPLIQUE/PLAFONIERA

230 V LED GU10 9 W

R13920 bianco

€ 48 NEW

R13921 nero

€ 48 NEW

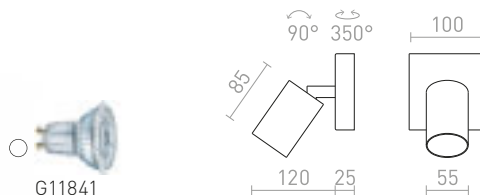

## DUDE

Plafoniera/applique per sorgente luminosa a LED con attacco GU10.

### DUDE R APPLIQUE/PLAFONIERA

230 V LED GU10 9 W

R13918 bianco

€ 48 NEW

R13919 nero

€ 48 NEW

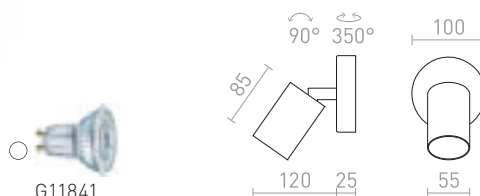

## DUDE

Plafoniera/applique a due riflettori per sorgenti LED con attacco GU10.

### DUDE II APPLIQUE/PLAFONIERA

230 V LED GU10 2x9 W

R13922 bianco

€ 98 NEW

R13923 nero

€ 98 NEW

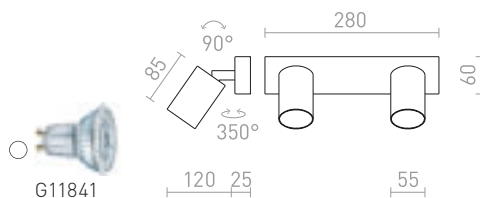



## DUDE

Lampada da parete con interruttore per sorgente luminosa a LED con attacco GU10.

**DUDE DA PARETE**  
230 V LED GU10 9 W

**R13924** bianco

€ 58 NEW

**R13925** nero

€ 58 NEW



G11841

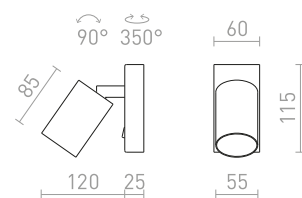









## DUGME

Faretto in metallo laccato in bianco con dettagli in antracite.

### DUGME I

230 V GU10 35 W

**R12076** bianco/grigio antracite

€ 58

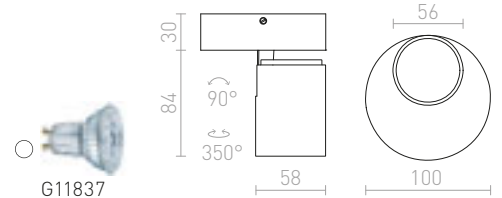

### DUGME II

230 V GU10 2x35 W

**R12077** bianco/grigio antracite

€ 120

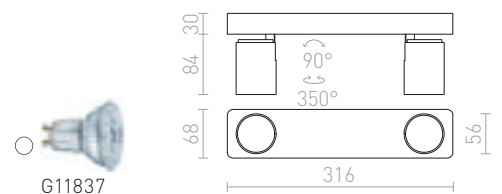

### DUGME III

230 V GU10 3x35 W

**R12078** bianco/grigio antracite

€ 129

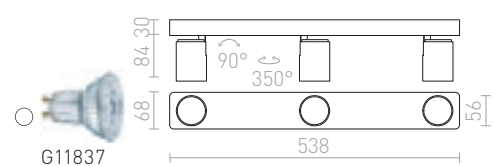



## TRICA

Faretto semplice in metallo, adatto per l'installazione a parete o soffitto, utilizzabile con le lampadine di design riflettenti con portalampana GU10.

### TRICA I DA PARETE

230 V GU10 25 W

**R13371** bianco

€ 22

%

**R13372** nero

€ 22

%



G11841

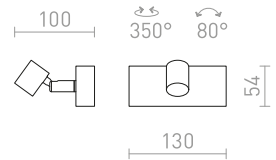

### TRICA II DA PARETE

230 V GU10 2x25 W

**R13373** bianco

€ 38

%

**R13374** nero

€ 38

%



G11841

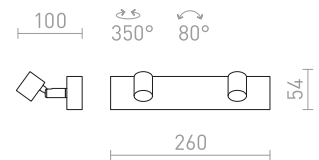

### TRICA III DA PARETE

230 V GU10 3x25 W

**R13375** bianco

€ 48

%

**R13376** nero

€ 48

%



G11841

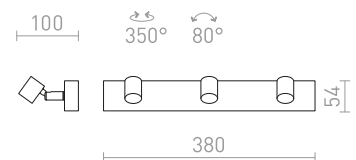





## KELLY LED

Applique o plafoniera con riflettori inclinabile. Fornito con sorgente luminoso LED integrato.

### KELLY LED I DA PARETE

230 V LED 12 W  $\angle 24^\circ$  3000 K 600 lm Ra 80

R12332 bianco

€ 120 ➔

R12333 nero

€ 120 ➔

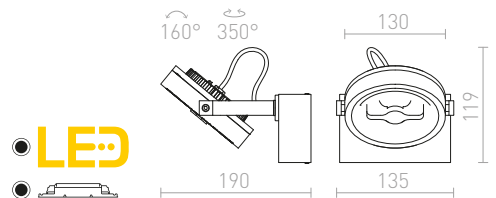

### KELLY LED II DA PARETE

230 V LED 2x12 W  $\angle 24^\circ$  3000 K 1200 lm Ra 80

R12334 bianco

€ 198 ➔

R12335 nero

€ 198 ➔

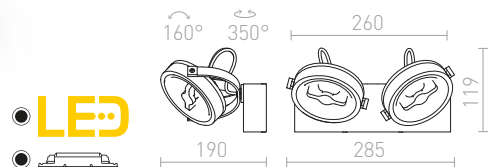

### KELLY LED III DA PARETE

230 V LED 3x12 W  $\angle 24^\circ$  3000 K 1800 lm Ra 80

R12336 bianco

€ 290 ➔

R12337 nero

€ 290 ➔

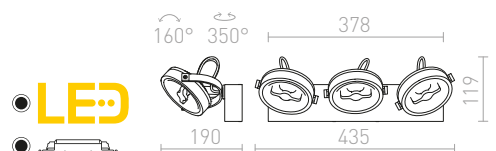





## KELLY LED

Faretto semi-incassato e dimmerabile con riflettore inclinabile a LED integrato. Per l'installazione nel soffitto di cartongesso. Dimmerazione TRIAC.

### KELLY LED DIMM SEMI-INCASSO

230 V LED 12 W  $\angle 24^\circ$  3000 K 600 lm Ra 80

R12637 bianco

€ 98

R12638 nero

€ 98

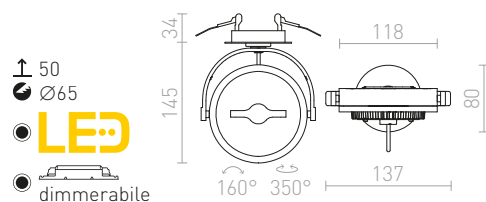







## KELLY LED

Applique o plafoniera con riflettore inclinabile e dimmerazione TRIAC. Fornito con sorgente luminoso LED integrato.

### KELLY LED I DIMM DA PARETE

230 V LED 12 W  $\angle 24^\circ$  3000 K 600 lm Ra 90

R13104 bianco

€ 129

R13105 nero

€ 129

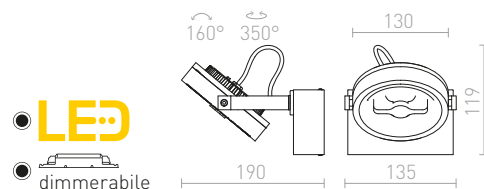

### KELLY LED II DIMM DA PARETE

230 V LED 2x12 W  $\angle 24^\circ$  3000 K 1200 lm Ra 90

R13106 bianco

€ 238

R13107 nero

€ 238

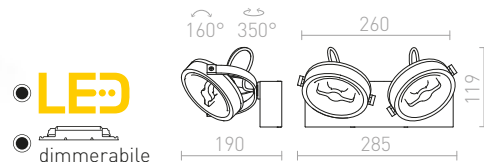

### KELLY LED III DIMM DA PARETE

230 V LED 3x12 W  $\angle 24^\circ$  3000 K 1800 lm Ra 80

R13108 bianco

€ 360

R13109 nero

€ 360

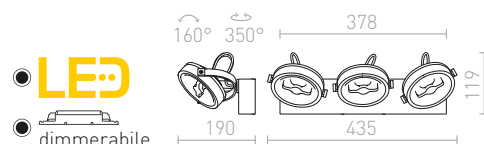





## ELISEO

Plafoniera/applique a LED con riflettori a ciotola rotante e diffusore bianco latte.

### ELISEO II APPLIQUE/PLAFONIERA

230 V LED 2x5 W 3000 K 760 lm Ra 80

R13916 bianco

€ 138

NEW

R13917 nero

€ 138

NEW

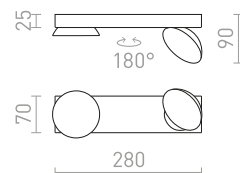

## ELISEO

Lampada da parete a LED con riflettore a ciotola rotante e diffusore bianco latte.

### ELISEO DA PARETE

230 V LED 5 W 3000 K 320 lm Ra 80

R13914 bianco

€ 88

NEW

R13915 nero

€ 88

NEW

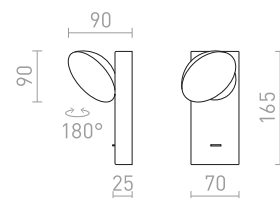
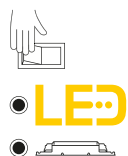





## GLOSSY

Applique con tre farettili inclinabili su due assi.

### GLOSSY I

230 V LED GU10 8 W

R10542 cromo

€ 48 %

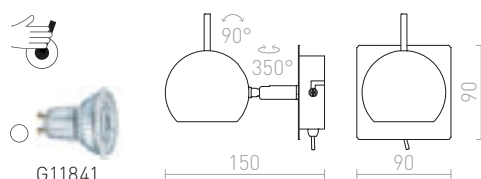

### GLOSSY III

230 V LED GU10 3x8 W

R10604 cromo

€ 78 %

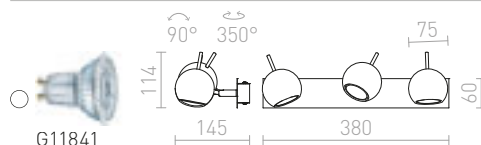

## GLOSSY

Applique con riflettore su collo di cigno. Interruttore a leva è situato sul lato inferiore dell'apparecchio.

### GLOSSY A COLLO DI CIGNO

230 V LED GU10 8 W

R10543 cromo

€ 58 %

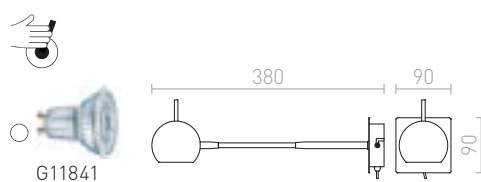





## ROSITA

Applique in stile retrò per sorgenti luminose a risparmio energetico GU10.

### ROSITA I DA PARETE

230 V LED GU10 9 W

R12507 bianco/grigio argento

€ 58

R12508 nero/oro

€ 58

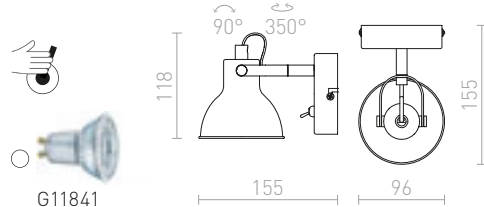

### ROSITA II DA PARETE

230 V LED GU10 2x9 W

R12509 bianco/grigio argento

€ 88

R12510 nero/oro

€ 120

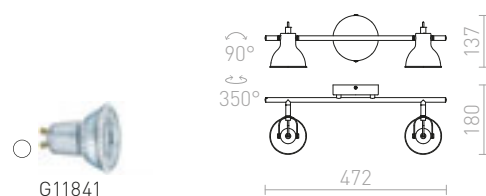



## EKE

Applique piccolo da parete con LED integrato su collo di cigno e interruttore posizionato sulla base.

### EKE DA PARETE

230 V LED 3 W  $\angle 60^\circ$  3000 K 100 lm Ra 80

R12944 bianco

€ 58

R12945 nero

€ 58

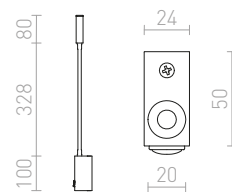

## FRISCO

Applique piccola con LED integrato su collo di cigno e interruttore posizionato sulla base. Il riflettore rettangolare offre un'ampia diffusione di luce.

### FRISCO W DA PARETE

230 V LED 4,2 W  $\angle 120^\circ$  3000 K 300 lm Ra 80

R12942 nero

€ 98 %

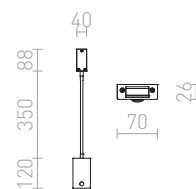



## AIM

Appliche a LED da parete su collo di cigno.  
L'interruttore tattile si trova sulla base.

### AIM A COLLO DI CIGNO

230 V LED 3 W  $\angle 45^\circ$  3000 K 180 lm Ra 80

R10541 nero

€ 150

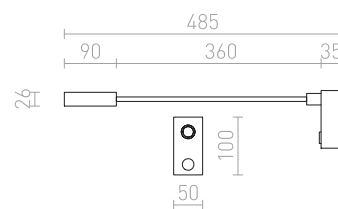





## POINT

Faretto a LED con collo di cigno. Interruttore a levetta si trova sulla parte inferiore della base.

### POINT DA PARETE

230 V LED 3 W  $\angle 40^\circ$  3000 K 240 lm Ra 80

R11758 nichel opaco

€ 68 %

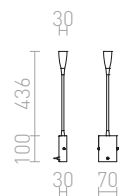



## VERSA

Faretto a diodo LED su collo di cigno. Interruttore a levetta si trova sul fondo di base.

### VERSA PARETE

230 V LED 3 W  $\angle 40^\circ$  3000 K 240 lm Ra 80

**R10602** nichel opaco

€ 88

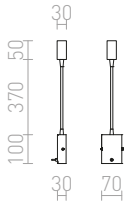

## SHOW

Faretto con LED integrato su collo di cigno per montaggio a parete.

### SHOW DA PARETE

230 V LED 3 W 3000 K 240 lm Ra 80

**R12896** bianco/cromo

€ 78

**R12897** nero/cromo

€ 78

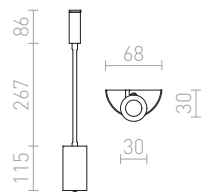

## BOB

Applique con LED integrato su collo di cigno. Apparecchio può essere comandato dall'interruttore a leva che si trova sulla base dell'apparecchio.

### BOB A COLLO DI CIGNO

230 V/500 mA LED 3 W  $\angle 45^\circ$  3000 K 180 lm Ra 80

**R10538** cromo

€ 120







## KAYA

Applique da parete in metallo su collo di cigno e interruttore posizionato sulla base, per sorgenti luminose con portalampada E27.

### KAYA DA PARETE

230 V E27 28 W

R12898 bianco/nichel opaco

€ 48



G13026

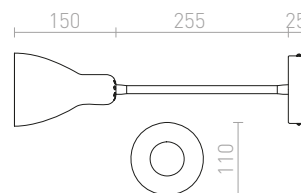

## FLAP

Applique piccola con LED integrato su collo di cigno, con riflettore circolare e interruttore posizionato sulla base.

### FLAP DA PARETE

230 V LED 4,2W  $\angle 120^\circ$  3000 K 100lm Ra 80

R12943 cromo

€ 68

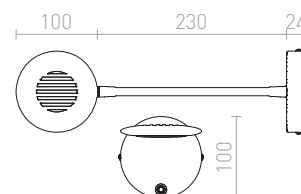



## VALE

Lampada applique a LED su collo flessibile con interruttore sulla base. Con l'aiuto di un manicotto posizionato sulla base è possibile attaccare il cavo di alimentazione per la presa. Il cavo non fa parte della confezione.

### VALE DA PARETE

230 V LED 3 W  $\angle 30^\circ$  3000 K 150 lm Ra 80

**R13647** bianco

€ 98

**R13648** nero

€ 98

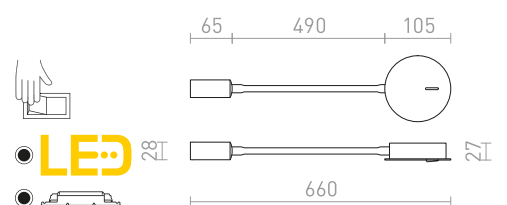



## CELEIA

Riflettore cilindrico girevole in metallo su base per utilizzo con lampadina E27.

### CELEIA APPLIQUE/PLAFONIERA

230 V E27 40 W

**R13901** bianco opaco/nichel opaco

€ 48

NEW

**R13902** nero opaco/rame spazzolato

€ 48

NEW

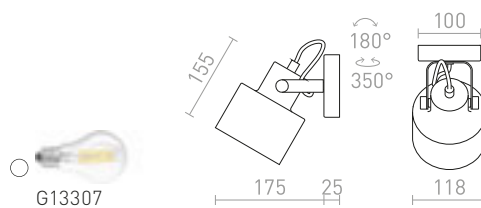

## BAROQUE

Piccola applique con riflettore ampio e interruttore posizionato sulla base, per sorgente luminosa con portalamпада E27.

### BAROQUE DA PARETE

230 V E27 28 W

**R12986** nero/cromo

€ 58

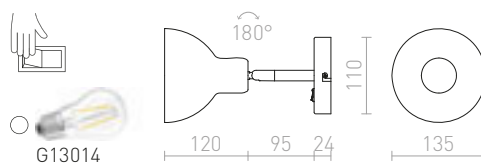



## AGNETA

Riflettore rotondo in metallo girevole sulla base per utilizzo con lampadina E27.

### AGNETA APPLIQUE/PLAFONIERA

230 V E27 40 W

**R13893** bianco

€ 48 NEW

**R13894** nero

€ 48 NEW

**R13895** ottone spazzolato/nero

€ 78 NEW

**R13896** rame spazzolato/nero

€ 78 NEW

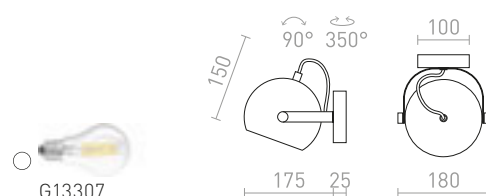

## JOLI

Faretto inclinabile in plastica a LED con portalampada GU10.

### JOLI I DA PARETE

230 V LED GU10 10 W

**R13556** nero

€ 38

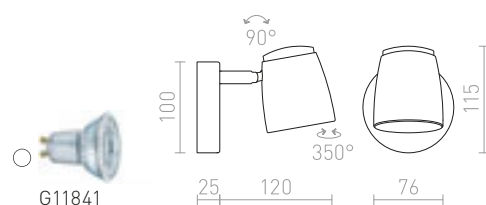



## BELENOS

Faretto cilindrico semplice su base rotonda, per sorgenti luminose con portalampada GU10. Le molle fissate alla base consentono l'uso di sorgenti luminose di varie lunghezze.

### BELENOS DA SOFFITTO

230 V LED GU10 9 W

**R13363** bianco

€ 48

**R13364** nero

€ 48

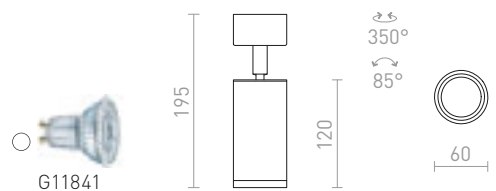



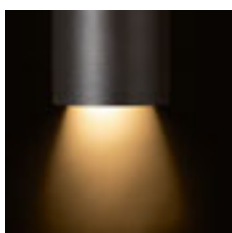

## OPTIMUS

Apparecchio cilindrico con la possibilità di regolare il cono di luce tramite il sistema di zoom 10-50°. L'apparecchio è adatto per sorgenti luminose LED con portalamada GU10. Da usare con sorgenti luminose con fascio di luce di 120° per evitare ombre indesiderate.

### OPTIMUS DA SOFFITTO

230 V LED GU10 9 W  $\angle$ 10-50°

R13779 bianco

€ 58

R13780 nero

€ 58

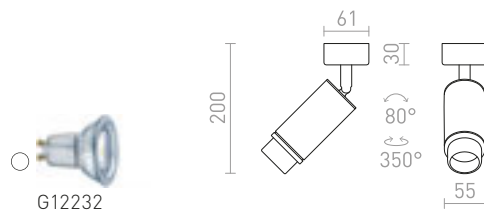

## BOGARD

Faretto a tubo da soffitto orientabile e con LED integrato.

### BOGARD DA SOFFITTO

230 V LED 5 W  $\angle$ 40° 3000 K 414 lm Ra 80

R12497 nero opaco

€ 68

R12498 nichel opaco

€ 78

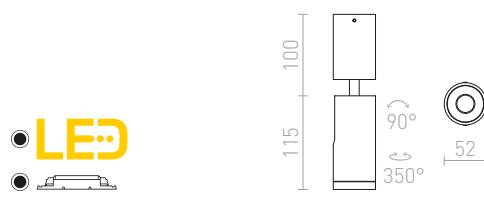

## BOGARD

Plafoniera con due faretto a LED, uno fisso e l'altro orientabile.

### BOGARD TWIN DA SOFFITTO

230 V LED 2x5 W  $\angle$ 40° 3000 K 700 lm Ra 80

R12499 nero opaco

€ 120

R12500 nichel opaco

€ 88

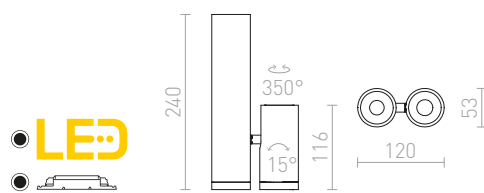



## DARIO

Faretto cilindrico inclinabile a soffitto per lampadina LED con attacco GU10 comprensivo di anello decorativo in metallo in colore ottone spazzolato. Se si vuole cambiare colore è possibile acquistare un anello in bianco o nero.

### DARIO DA SOFFITTO

230 V GU10 9 W

**R13867** bianco/ottone spazzolato

€ 68

NEW

**R13868** nero/ottone spazzolato

€ 68

NEW

**R13869** ottone spazzolato

€ 78

NEW



G11841

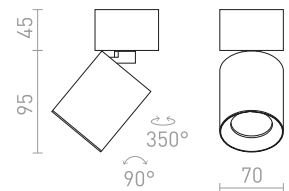

## DARIO

Anello decorativo in alluminio per la possibilità di cambiare il colore delle lampade DARIO.

### DARIO ANELLO DECORATIVO

**R13876** bianco

€ 8.50

NEW

**R13877** nero

€ 8.50

NEW

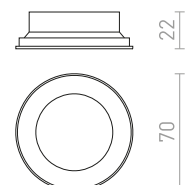
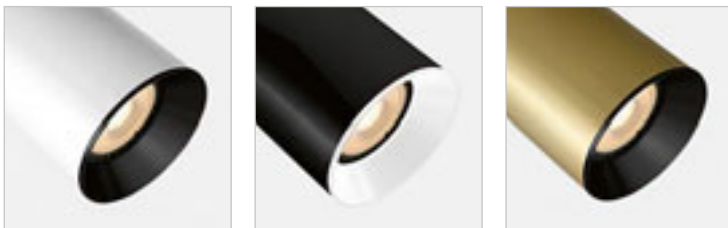

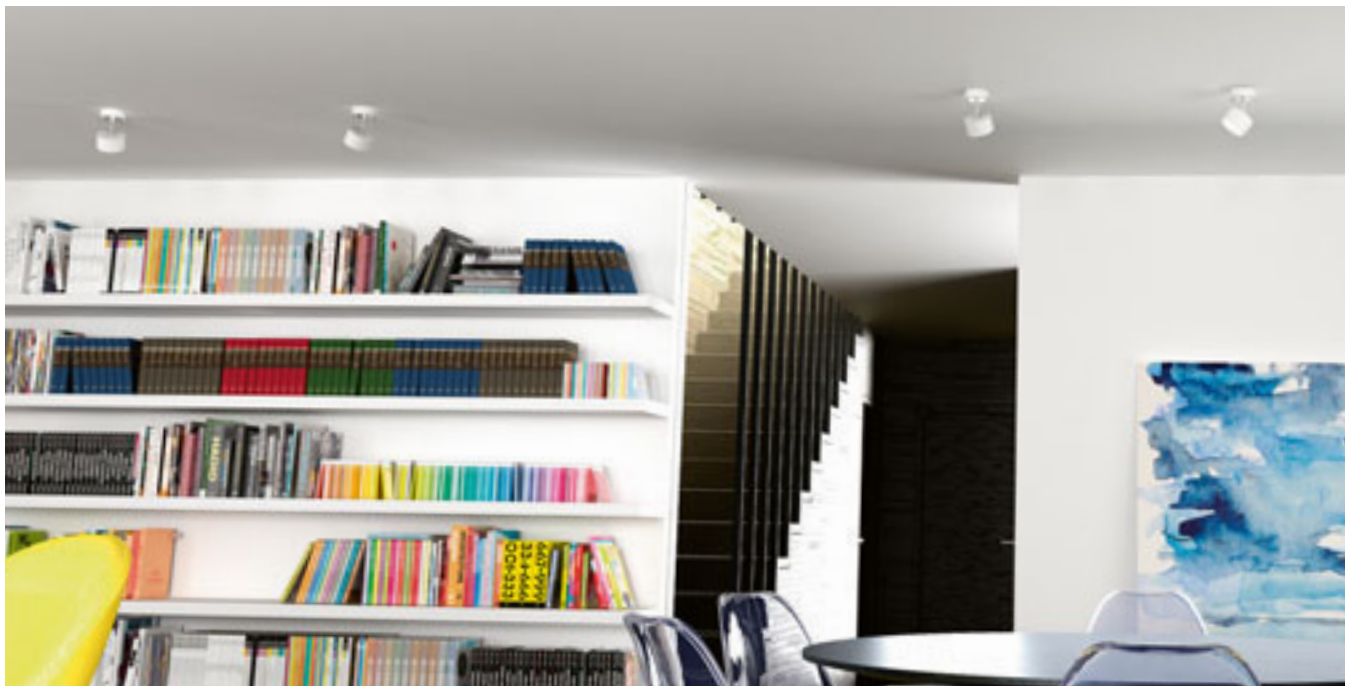

## PIXIE

Apparecchio inclinabile su base, per lampadine LED a risparmio energetico con portalampada GX53.

### PIXIE INCLINABILE

230 V LED GX53 7 W

**R11772** bianco/cromo

€ 138

**R11773** nero/cromo

€ 138

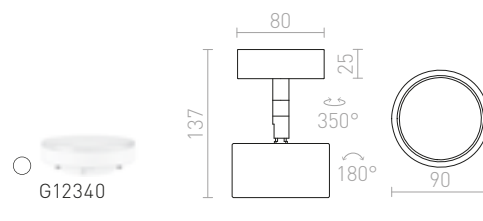

IP44



## ORIT

Faretto da esterno inclinabile in alluminio robusto con LED 6W integrato. Inclinabile solo su un asse.

### ORIT DA PARETE

230 V LED 6 W  $\angle 80^\circ$  3000 K 315 lm Ra 80 IP44

**R12033** alluminio

€ 78

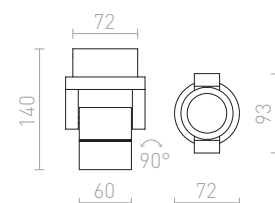



## REDO

Riflettore inclinabile di alluminio robusto.

### REDO INCLINABILE

230 V GU10 50 W

R10173 alluminio

€ 35 →

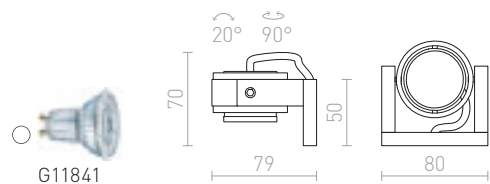

G11841



## MARVEL

Lampada quadrata in alluminio, per due lampadine dicroiche con portalampada GU10 che possono essere inclinate individualmente su una base centrale.

### MARVEL II INCLINABILE

230 V GU10 2x50 W

R10171 alluminio

€ 48 %



G11841

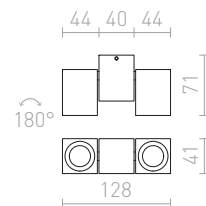

## CASSIE

Applique o plafoniera con riflettore orientabile.

### CASSIE DA PARETE

230 V/12 V G53 50 W

R10591 nichel opaco

€ 58 %



G13656

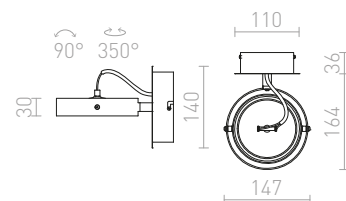

## BUGSY

Applique da parete con paralume in vetro a specchio su base cromata.

### BUGSY I DA PARETE

230 V GU10 50 W

R10521 vetro cromato

€ 48 %



G11841

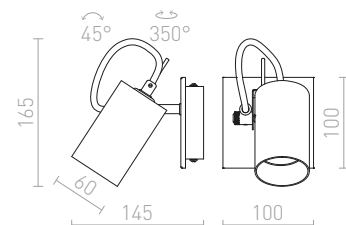



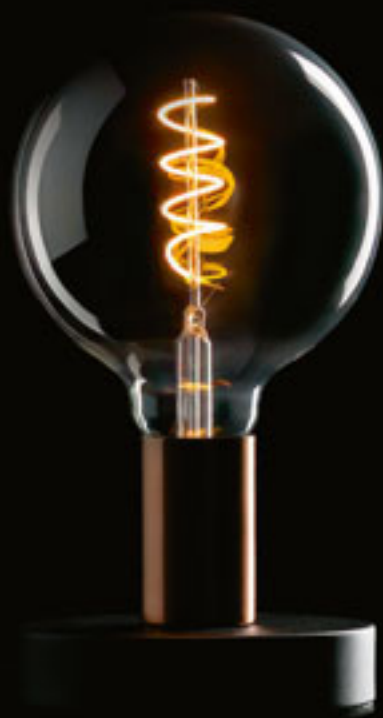

## LAMPADE DA TAVOLO

DECORATIVE 322-339

DA LAVORO 340-347

# DA TAVOLO DECORATIVE

322-339



**AMBITUS/ALVIS 24**  
322-323



**ALVIS/AMBITUS 30**  
322-323



**EL PASO**  
324-325



**GARDETTE**  
324-325



**ALVIS/RON 40**  
324-325



**KEITH/ALVIS 24**  
326-327



**KEITH/DELISA**  
326-327



**MAUI/ALVIS 24**  
326-327



**BROADWAY**  
326-327



**KEITH/AMBITUS 30**  
328-329



**MAUI/AMBITUS 30**  
328-329



**PERTH**  
328-329



**ESPLANADE**  
330-331



**EDIKA**  
330-331



**LAURA**  
330-331



**LULU**  
332-333



**MAUI/CONNY 15/30**  
332-333



**NYC/CONNY 15/15**  
332-333



**NYC/CONNY 15/30**  
332-333



**KEITH/RON 15/20**  
334-335



**NYC/RON 15/20**  
334-335



**ZUMBA**  
334-335



**NYC/TEMPO 15/30**  
336-337



**MONACO**  
336-337



**PLAZA S**  
336-337



**PLAZA M**  
336-337



**CAMINO**  
338-339



**CAMINO**  
338-339



**HEIDI**  
338-339



**ALGOT**  
338-339

## DA TAVOLO DA LAVORO

340-347



**MONTANA**  
340-341



**RITZY**  
340-341



**NIZZA**  
340-341



**GARBO**  
342-343



**ANIKA**  
342-343



**CELEIA**  
342-343



**BUGSY**  
344-345



**JOLI**  
344-345



**ROSITA**  
344-345



**FRISCO T**  
344-345



**FADO**  
346-347



**VIPER TL**  
346-347



**COZY**  
346-347



**TAPIO**  
346-347







### AMBITUS/ALVIS

Lampada da tavolo con paralume in tessuto ed un'elegante base in bambù. Adatta per sorgenti luminose a LED con filettatura E27.

#### AMBITUS/ALVIS 24 DA TAVOLO

230 V LED E27 7 W

R14040 bianco crema/bambù

€ 150 **NEW**



G13015

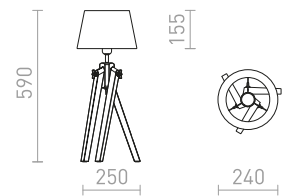

### ALVIS/AMBITUS

Lampada da tavolo con paralume in tessuto ed un'elegante base in bambù. Adatta per sorgenti luminose a LED con filettatura E27.

#### ALVIS/AMBITUS 30 DA TAVOLO

230 V LED E27 11 W

R14041 policotone bianco/bambù

€ 178 **NEW**



G13026

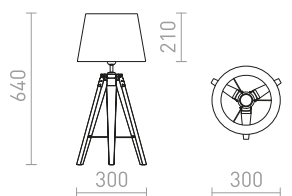



## ALVIS/RON

Lampada da tavolo con paralume in tessuto ed un'elegante base in bambù. Adatta per sorgenti luminose a LED con filettatura E27.

### ALVIS/RON 40 DA TAVOLO

230 V LED E27 11 W

R14042 policotone bianco/bambù

€ 188 **NEW**

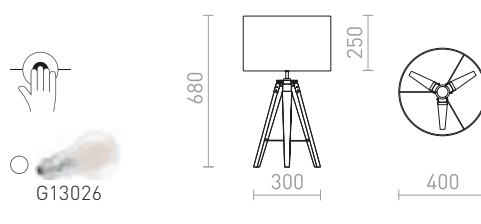

## GARDETTE

Lampada da tavolo su treppiede con sistema regolabile in altezza, con paralume in tessuto e portalampada E27.

### GARDETTE DA TAVOLO

230 V E27 42 W

R12488 nero/alluminio

€ 150 **%**

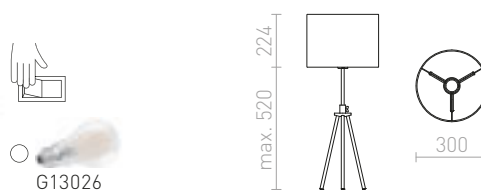



## EL PASO

Lampada da tavolo con piedistallo in bambù e con paralume in tessuto. Fornita non assemblata, è necessario completarla.

### EL PASO DA TAVOLO

230 V E14 11 W

R13338 grigio/bambù

€ 68 %



G12243

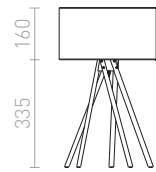



## KEITH/ALVIS

Lampada da tavolo con paralume in tessuto e porta USB integrata nella base. La base è in finto faggio con dettagli laccati in bianco. Adatta per sorgenti luminose a LED con filettatura E27.

### KEITH/ALVIS 24 DA TAVOLO CON USB

230 V LED E27 7 W

R14038 bianco crema/faggio

€ 138 **NEW**

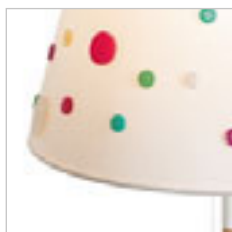
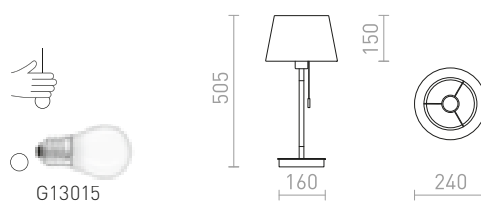

## KEITH/DELISA

Lampada da tavolo con paralume decorato con bottoni colorati e porta USB integrata nella base. La base è in finto faggio con dettagli laccati in bianco. Adatta per sorgenti luminose a LED con filettatura E27.

### KEITH/DELISA DA TAVOLO CON USB

230 V LED E27 7 W

R14037 bianco/bottoni/faggio

€ 129 **NEW**





## MAUI/ALVIS

Lampada da tavolo con base in legno e paralume in tessuto. Adatta a sorgenti luminose a LED con filettatura E27.

### MAUI/ALVIS 24 DA TAVOLO

230 V LED E27 7 W

R14033 bianco crema/legno

€ 98 **NEW**



G13015

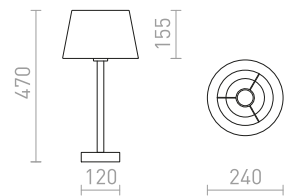

## BROADWAY

Lampada da tavolo con paralume in tessuto strutturato bianco e base cromata.

### BROADWAY DA TAVOLO

230 V E27 42 W

R11986 bianco/cromo

€ 178 **➔**



G13026

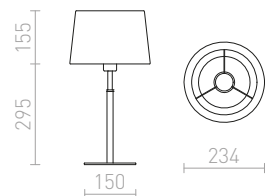





## KEITH/AMBITUS

Lampada da tavolo con paralume in tessuto e porta USB integrata nella base. La base è in finto faggio con dettagli laccati in bianco. Adatta per sorgenti luminose a LED con filettatura E27.

### KEITH/AMBITUS 30 DA TAVOLO CON USB

230 V LED E27 11 W

R14039 policotone bianco/faggio

€ 178 **NEW**



G13026

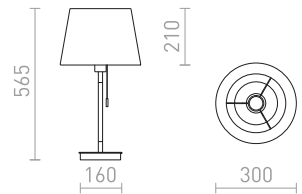

## MAUI/AMBITUS

Lampada da tavolo con base in legno e paralume in tessuto. Adatta per sorgenti luminose a LED con filettatura E27.

### MAUI/AMBITUS 30 DA TAVOLO

230 V LED E27 11 W

R14035 policotone bianco/legno

€ 120 **NEW**



G13026

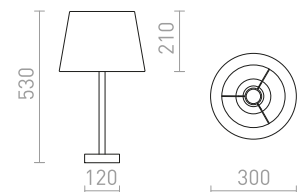

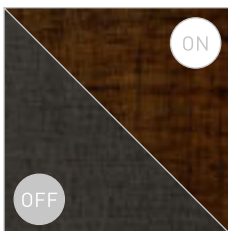
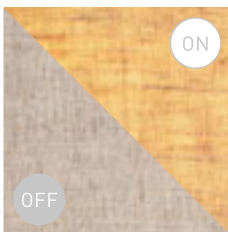

## PERTH

Lampada da tavolo con paralume tessile quadrato e con piedistallo metallico.

### PERTH DA TAVOLO

230 V E27 15 W

**R13663** beige/bianco

€ 150

**R13664** nero/nero

€ 150



G13307

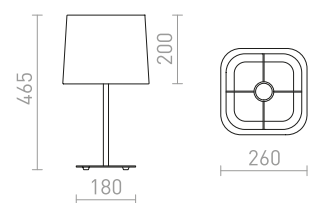



## EDIKA

Lampada da tavolo in nichel con piede telescopico e paralume in tessuto, con portalampana E27.

### EDIKA DA TAVOLO

230 V E27 42 W

**R12665** marrone/nichel opaco

**€ 138** ➔



G13026

max. 59%

200



300

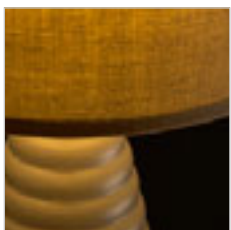

## LAURA

Lampada da tavolo decorativa con paralume in tessuto.

### LAURA DA TAVOLO

230 V E27 28 W

**R13324** grigio beige

**€ 48** ➔

**R13325** nero

**€ 58** ➔



G13026

300

200

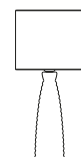

230



## ESPLANADE

Lampada da tavolo con doppio paralume in tessuto, con piede telescopico e con portalampada E27.

### ESPLANADE DA TAVOLO

230 V E27 42 W

R12484 nero trasparente/bianco/cromo

€ 268



G13026

max. 525  
218

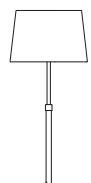

327





## NYC/CONNY

Lampada da tavolo con paralume in tessuto e base in metallo.  
Adatta per sorgenti luminose a LED con filettatura E27.

### NYC/CONNY 15/15 DA TAVOLO

230 V LED E27 7 W

|   |   |       |     |
|---|---|-------|-----|
|   | <b>R14047</b><br>policotone bianco/cromo  | € 120 | NEW |
|  | <b>R14048</b><br>policotone bianco/nichel | € 120 | NEW |

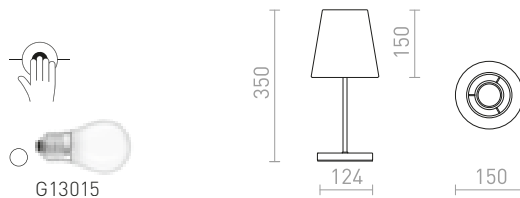

### NYC/CONNY 15/30 DA TAVOLO

230 V LED E27 7 W

|   |   |       |     |
|---|---|-------|-----|
|  | <b>R14049</b><br>policotone bianco/cromo            | € 120 | NEW |
|  | <b>R14050</b><br>policotone bianco/nichel           | € 120 | NEW |
|  | <b>R14051</b><br>grigio piccione/PVC argento/cromo  | € 150 | NEW |
|  | <b>R14052</b><br>grigio piccione/PVC argento/nichel | € 150 | NEW |
|  | <b>R14053</b><br>Monaco benzina/PVC argento/cromo   | € 150 | NEW |
|  | <b>R14054</b><br>Monaco benzina/PVC argento/nichel  | € 150 | NEW |

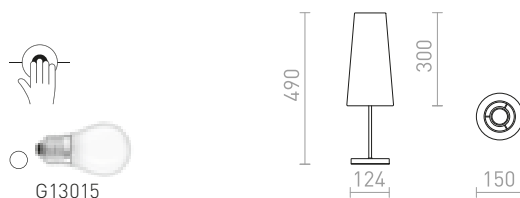





### MAUI/CONNY

Lampada da tavolo con base in legno e paralume in tessuto. Adatta per sorgenti luminose a LED con filettatura E27.

#### MAUI/CONNY 15/30 DA TAVOLO

230 V LED E27 7 W

R14034 policotone bianco/legno

€ 120

NEW

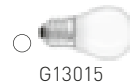

G13015

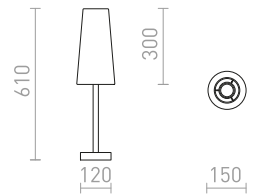

### LULU

Lampada da tavolo con paralume conico di tessuto e con portalampada E27. La base è una combinazione elegante di parte cromata e colore nero.

#### LULU DA TAVOLO

230 V E27 28 W

R12464 bianco/nero/cromo

€ 129

R12465 nero/cromo

€ 129



G13026

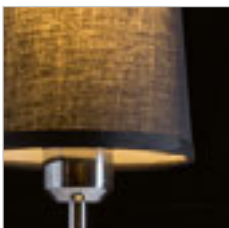
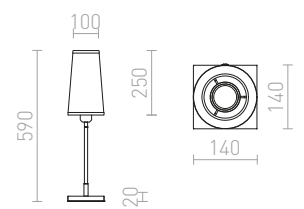



## NYC/RON

Lampada da tavolo con paralume in tessuto e base in metallo.  
Adatta per sorgenti luminose a LED con filettatura E27.

### NYC/RON 15/20 DA TAVOLO

230 V LED E27 7 W

|  |   |       |     |
|--|---|-------|-----|
|  | <b>R14055</b><br>policotone bianco/cromo            | € 120 | NEW |
|  | <b>R14056</b><br>policotone bianco/nichel           | € 120 | NEW |
|  | <b>R14057</b><br>grigio piccione/PVC argento/cromo  | € 150 | NEW |
|  | <b>R14058</b><br>grigio piccione/PVC argento/nichel | € 150 | NEW |
|  | <b>R14059</b><br>Monaco benzina/PVC argento/cromo   | € 150 | NEW |
|  | <b>R14060</b><br>Monaco benzina/PVC argento/nichel  | € 150 | NEW |
|  | <b>R14061</b><br>policotone nero/cromo              | € 120 | NEW |
|  | <b>R14062</b><br>policotone nero/nichel             | € 120 | NEW |



G13026

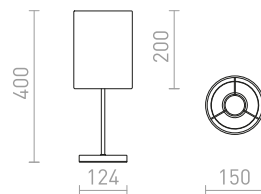



## KEITH/RON

Lampada da tavolo con paralume in tessuto e porta USB integrata nella base. La base è in finto faggio con dettagli laccati in bianco. Adatta per sorgenti luminose a LED con filettatura E27.

### KEITH/RON 15/20 DA TAVOLO CON USB

230V LED E27 7W

R14036 policotone bianco/faggio

€ 158

NEW



G13026

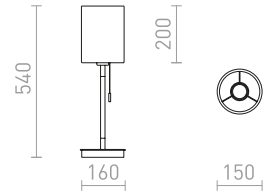

## ZUMBA

Lampada da tavolo con piedistallo in legno e paralume in plastica. Fornito smontato, montaggio richiesto.

### ZUMBA DA TAVOLO

230V E14 11W

R13320 PVC bianco/legno/cromo

€ 48

%



G11849

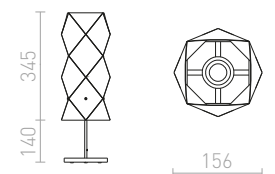



## MONACO

Lampada da scrivania compatta con paralume in tessuto nero e base cromata.

### MONACO DA TAVOLO

230 V E27 28 W

R12040 nero/cromo

€ 32 



G13026

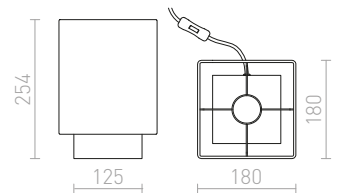



## PLAZA

Lampada da tavolo con paralume in tessuto strutturato.

### PLAZA S DA TAVOLO

230 V E27 42 W

R11973 bianco/cromo

€ 158

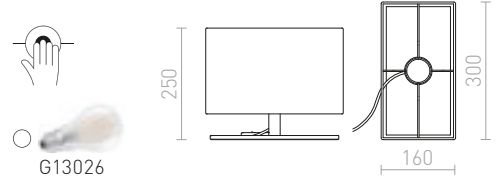

### PLAZA M DA TAVOLO

230 V E27 42 W

R11983 bianco/cromo

€ 215

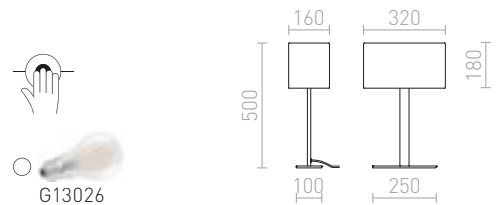

## NYC/TEMPO

Lampada da tavolo con paralume in tessuto e base in metallo. Adatta per sorgenti luminose a LED con filettatura E27.

### NYC/TEMPO 15/30 DA TAVOLO

230 V LED E27 7 W

R14063 policotone bianco/cromo

€ 129

NEW

R14064 policotone bianco/nichel

€ 129

NEW

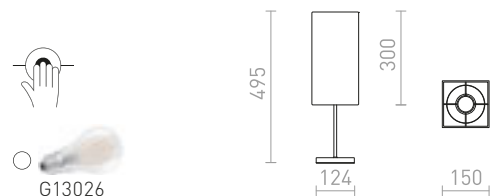





## ALGOT

Lampada da tavolo da utilizzare con una lampadina decorativa con attacco E27.

### ALGOT DA TAVOLO

230 V E27 40 W

R13907 nero/rame spazzolato

€ 25 **NEW**



G13459

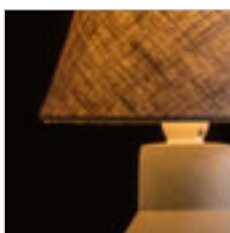
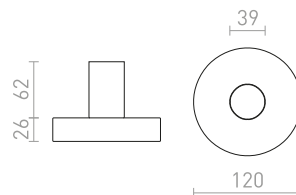

## HEIDI

Lampada da tavolo decorativa in calcestruzzo con paralume in tessuto e portalampana E14.

### HEIDI DA TAVOLO

230 V E14 12 W

R12379 naturale/calcestruzzo

€ 48



G12243

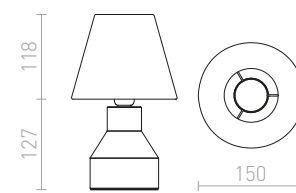



## CAMINO

Lampada da tavolo cilindrica semplice con paralume in tessuto. Il decoro di ogni apparecchio è originale.

### CAMINO DA TAVOLO CON PARALUME

230 V E27 28 W

**R13294** bianco/terrazzo decor

€ 78

**R13295** bianco/cemento

€ 78



G13026

200  
135

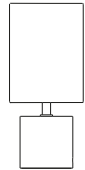

150



## CAMINO

Lampada da tavolo semplice dalla forma cilindrica, per sorgenti luminose decorative. Il decoro di ogni apparecchio è originale.

### CAMINO DA TAVOLO

230 V E27 28 W

**R13293** terrazzo decor

€ 48



G13311

110

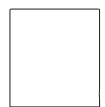

100



## RITZY

Lampada da tavolo in colore nero e cromo con paralume in tessuto e con sistema di regolazione telescopica dell'altezza della lampada. Adatto per le lampadine con portalampada E27.

### RITZY DA TAVOLO

230 V E27 42 W

R12486 nero/cromo

€ 178 %



G13026

max. 550  
150

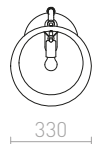
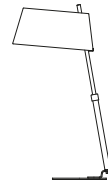



## NIZZA

Lampada da tavolo con braccio regolabile in legno e base in metallo laccato, compreso il paralume in tessuto. Cavo di alimentazione in tessuto nero.

### NIZZA DA TAVOLO

230 V LED E14 7 W

**R14031** policotone bianco/legno

€ 178 **NEW**

**R14032** policotone nero/legno

€ 188 **NEW**



G12243

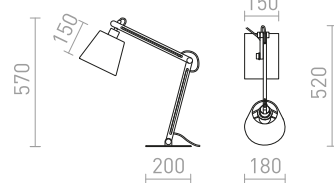

## MONTANA

Lampada da tavolo di metallo con doppio braccio regolabile e paralume in tessuto.

### MONTANA DA TAVOLO

230 V E27 28 W

**R13283** bianco/nero/cromo

€ 320 **➔**



G13014

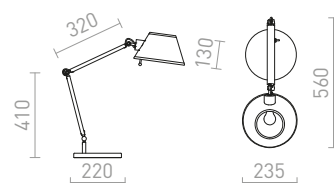



## ANIKA

Lampada da tavolo in metallo con collo flessibile da utilizzare con una lampadina E27.

### ANIKA DA TAVOLO

230 V E27 40 W

**R13905** bianco opaco/nichel opaco

€ 68

NEW

**R13906** nero opaco/nichel opaco

€ 68

NEW

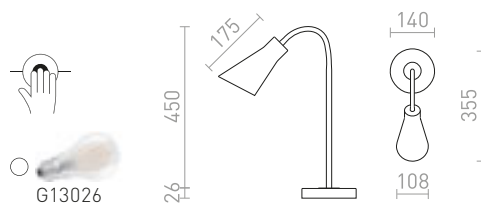

## CELEIA

Lampada da tavolo in metallo con riflettore cilindrico da utilizzare con una lampadina E27.

### CELEIA DA TAVOLO

230 V E27 40 W

**R13903** bianco opaco/nichel opaco

€ 98

NEW

**R13904** nero opaco/rame spazzolato

€ 98

NEW

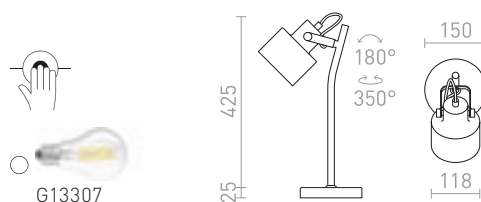





## GARBO

Lampada da tavolo in metallo con snodo e con portalampada E27.

### GARBO DA TAVOLO

230 V E27 28 W

R12675 nero/cromo

€ 58



G13026

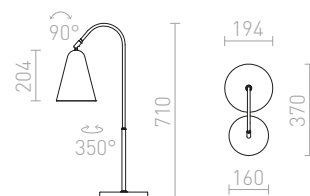



## BUGSY

Lampada da tavolo con paralume in vetro a specchio, inclinabile su un asse.

### BUGSY DA TAVOLO

230 V GU10 50 W

R10519 vetro cromato

€ 120 %



G11841

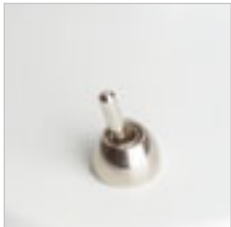
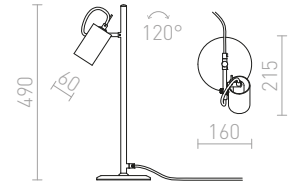

## ROSITA

Lampada da tavolo in stile retrò per sorgenti luminose GU10 a risparmio energetico.

### ROSITA DA TAVOLO

230 V LED GU10 9 W

R12512 nero/oro

€ 120



G11841

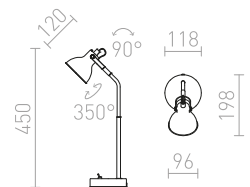

## FRISCO

Lampada da tavolo a LED su collo di cigno e interruttore sulla base. Il riflettore rettangolare offre un'ampia diffusione di luce.

### FRISCO T DA TAVOLO

230 V LED 4,2 W  $\angle 120^\circ$  3000 K 300 lm Ra 80

R12940 nero

€ 120 %

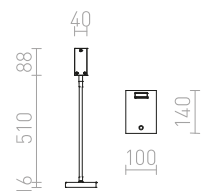



## JOLI

Lampada da tavolo in plastica a LED con portalampada GU10.

**JOLI DA TAVOLO**  
230V LED GU10 10W

**R13558** nero

€ 58



G11841

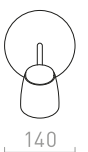
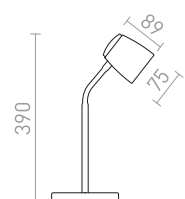



## TAPIO

Lampada da tavolo con riflettore LED cilindrico direzionale tramite snodo.

### TAPIO DA TAVOLO

230 V LED 4,5 W 3000 K 350 lm Ra 80

R13429 nero

€ 98

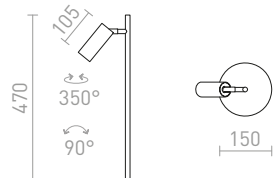
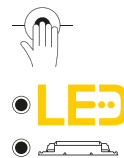



## FADO

Lampada da tavolo con design quadrato e riflettore LED orientabile.

### FADO DA TAVOLO

230 V LED 3 W  $\angle 45^\circ$  3000 K 110 lm Ra 80

R12474 nero

€ 120

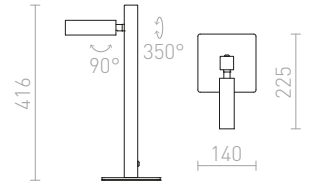

## VIPER

Lampada da tavolo di design con LED. Riflettore scorrevole nero, cavo in tessuto rosso e particolari cromati.

### VIPER TL

230 V LED 3 W  $\angle 60^\circ$  3000 K 100 lm Ra 80

R12462 nero/cromo

€ 150

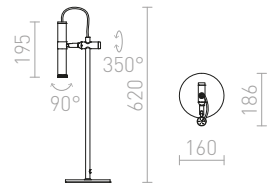

## COZY

Lampada da tavolo a LED elegante, posizionata su treppiede in metallo opaco. Il trasformatore fa parte dell'adattatore della presa.

### COZY DA TAVOLO

230 V LED 3,5 W 3000 K 240 lm Ra 80

R11759 nichel opaco

€ 58

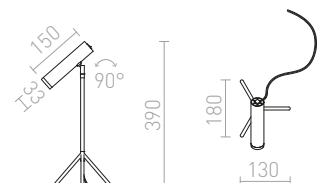





## LAMPADE DA TERRA

|            |         |
|------------|---------|
| DECORATIVE | 352-367 |
| DA LETTURA | 368-371 |

# DA TERRA DECORATIVE

352-367



**ALVIS/AMBITUS 46**  
352-353



**ALVIS/ILUSION**  
352-353



**AMBITUS 46**  
352-353



**ALVIS/RIDICK**  
352-353



**LUTON/ILUSION**  
354-355



**LUTON/RIDICK**  
354-355



**BOULOGNE**  
354-355



**GARDETTE**  
356-357



**LUTON/RON 55**  
356-357



**NAUTIC**  
356-357



**DANTE**  
358-359



**RITZY**  
358-359



**ESPLANADE**  
358-359



**EDIKA**  
360-361



**ETESIAN**  
360-361



**NYC/ILUSION**  
360-361



**NYC/RON 40/25**  
362-363



**CORTINA/JAKARANDA**  
362-363



**LULU**  
364-365



**NYC/CONNY 25**  
364-365



**NYC/CONNY 35**  
364-365



**PLAZA**  
366-367



**NYC/TEMPO 30/19**  
366-367



**PERTH**  
366-367

# DA TERRA DA LETTURA

368-371



**PRAGMA**  
368-369



**VARIA**  
368-369



**ROSITA**  
368-369



**STIG**  
368-369



**VIPER FL**  
370-371



**BUGSY**  
370-371



**FADO**  
370-371



## ALVIS/AMBITUS

Lampada da terra con paralume in tessuto. La base in bambù ad altezza regolabile. Adatta per sorgenti luminose a LED con filettatura E27.

### ALVIS/AMBITUS 46 DA TERRA

230 V LED E27 11 W

R14044 bianco crema/bambù

€ 320 **NEW**



G13461

1000 - 1460



620

240



460



## ALVIS/ILUSION

Lampada da terra con paralume in lamina cromata. La base in bambù ad altezza regolabile. Adatta per sorgenti luminose a LED con filettatura E27.

### ALVIS/ILUSION DA TERRA

230 V LED E27 11 W

R14045 pellicola cromata/bambù

€ 320 **NEW**



G13461

1090 - 1500



620

330



450





## ALVIS/RIDICK

Lampada da terra con paralume in lamina nera lucida con interno dorato. La base è in bambù con altezza regolabile. Adatta per sorgenti luminose LED con filettatura E27.

### ALVIS/RIDICK DA TERRA

230 V LED E27 11 W

**R14046** nero lucido/lamina d'oro/bambù

€ 278 **NEW**

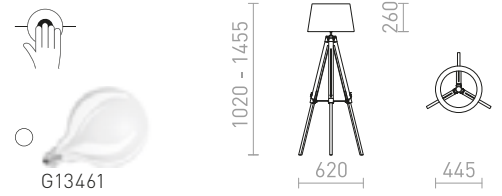

## AMBITUS

Lampada da tavolo con paralume in tessuto ed un'elegante base in bambù. Adatta per sorgenti luminose a LED con filettatura E27.

### AMBITUS 46 DA TERRA

230 V LED E27 11 W

**R14043** bianco crema/bambù

€ 380 **NEW**

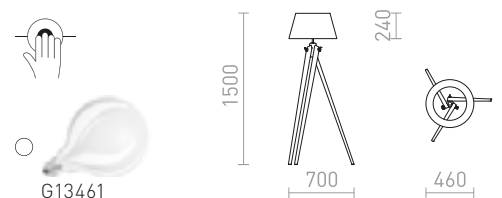



## LUTON/ILUSION

Elegante lampada da terra con paralume in lamina PVC cromata. Base in metallo laccato ad altezza regolabile con accessori in ottone. Adatta per sorgenti luminose a LED con filettatura E27.

### LUTON/ILUSION DA TERRA

230 V LED E27 11 W

**R14065** pellicola cromata/nero/metallo

€ 248 **NEW**



G13026

1280 - 1840



330



450

600



## LUTON/RIDICK

Elegante lampada da terra con paralume in lamina nera lucida con interno dorato. Base in metallo laccato ad altezza regolabile con accessori in ottone. Adatta per sorgenti luminose a LED con filettatura E27.

### LUTON/RIDICK DA TERRA

230 V LED E27 11 W

**R14066** nero lucido/lamina d'oro/nero/metallo

€ 215 **NEW**



G13026

1210 - 1770



260



445

600

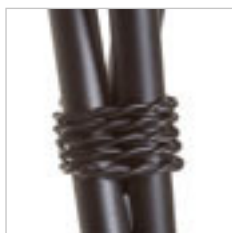

## BOULOGNE

Lampada da terra su treppiede con paralume rivestito da doppia fascia in tessuto nero.

### BOULOGNE DA TERRA

230 V E27 28 W

R12674 nero

€ 290 



G13461

1500  
285

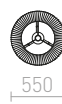

550



## GARDETTE

Lampada da terra su treppiede con sistema regolabile in altezza, con paralume in tessuto e portalampada E27.

**GARDETTE DA TERRA**

230 V E27 42 W

**R12489** nero/alluminio

€ 360 %



G13029

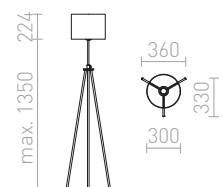



## LUTON/RON

Elegante lampada da terra con paralume in tessuto. Base in metallo laccato ad altezza regolabile con accessori in ottone. Adatta per sorgenti luminose a LED con filettatura E27.

### LUTON/RON 55 DA TERRA

230 V LED E27 11 W

**R14067** policotone bianco/nero/metallo

€ 268 **NEW**

**R14068** policotone nero/nero/metallo

€ 268 **NEW**

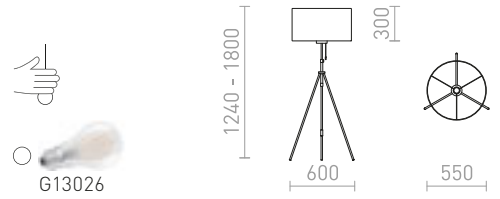

## NAUTIC

Lampada da terra in stile retrò su treppiede di legno e riflettore orientabile. Per sorgenti luminose con portalampana E27.

### NAUTIC DA TERRA

230 V E27 20 W

**R13394** nero/cromo

€ 178 **➔**

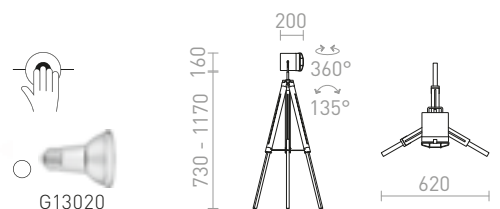





## RITZY

Lampada da terra in colore nero e cromo con paralume in tessuto e con sistema di regolazione telescopica dell'altezza della lampada. Adatto per le lampadine con portalampada E27.

### RITZY DA TERRA

230 V E27 42 W

R12487 nero/cromo

€ 560 %



max. 1495 210

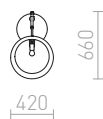



## DANTE

Lampada da terra robusta di design moderno adatta per interni spaziosi. Combinazione di legno, metallo e paralume di tessuto.

### DANTE DA TERRA

230 V E27 25 W

**R13653** nero/legno

€ 620

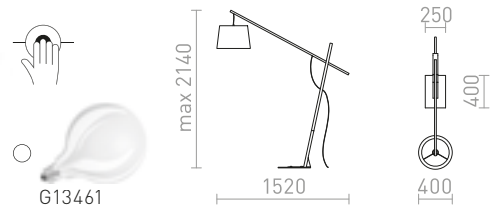

## ESPLANADE

Lampada da terra con altezza regolabile e doppio paralume in tessuto.

### ESPLANADE DA TERRA

230 V E27 42 W

**R12485** nero trasparente/bianco/cromo

€ 520

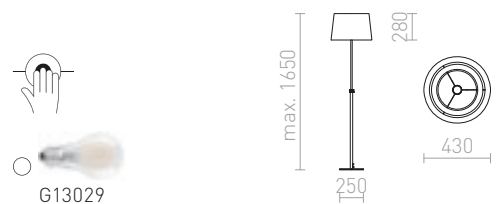



## EDIKA

Lampada da terra in nichel con piede telescopico e paralume in tessuto, con portalampada E27.

### EDIKA DA TERRA

230 V E27 42 W

R12666 marrone/nichel opaco

€ 198 ➔



G13026

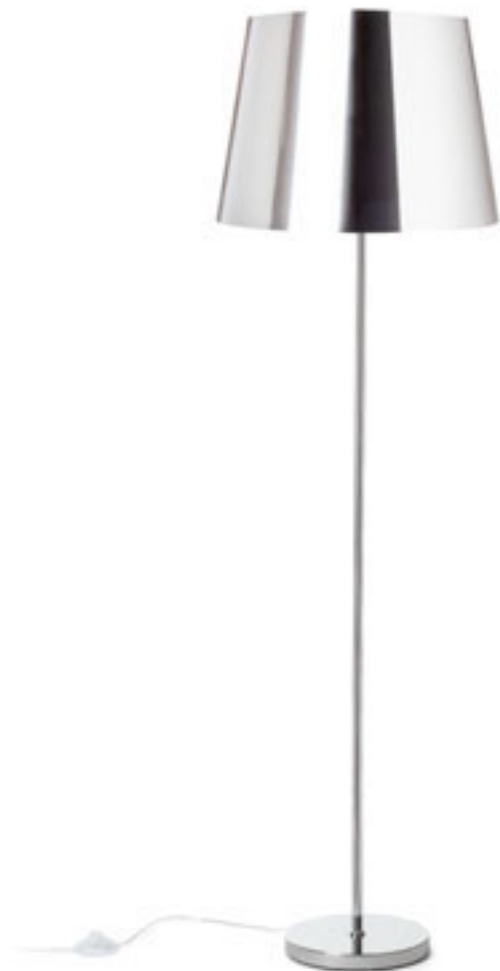
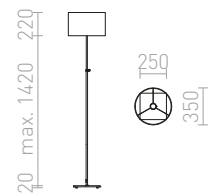

## NYC/ILUSION

Lampada da terra con base cromata e paralume in lamina cromata. Adatta per sorgenti luminose a LED con filettatura E27.

### NYC/ILUSION DA TERRA

230 V LED E27 11 W

R14073 pellicola cromata/cromo

€ 198 NEW



G13026

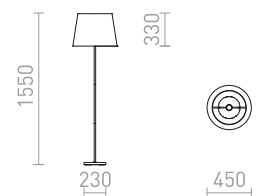



## ETESIAN

Lampada da terra sottile con paralume in tessuto e con portalampana E27.

### ETESIAN DA TERRA

230 V E27 28 W

R12470 nero

€ 178



G13026

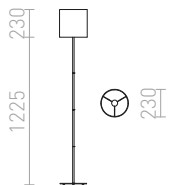



## CORTINA/JAKARANDA

Lampada da terra con paralume in tessuto con superficie geometrica 3D e base in metallo laccato. Adatta per sorgenti luminose a LED con filettatura E27.

### CORTINA/JAKARANDA DA TERRA

230 V LED E27 11 W

**R14069** bianco/bianco/tessuto/metallo

€ 188 NEW

**R14070** nero/bianco/tessuto/metallo

€ 188 NEW

**R14071** bianco/nero/tessuto/metallo

€ 188 NEW

**R14072** nero/nero/tessuto/metallo

€ 188 NEW

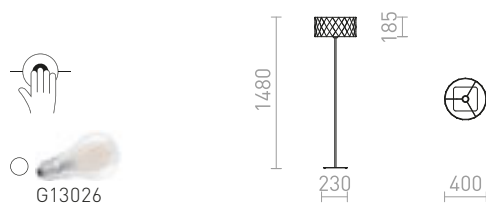





## NYC/RON

Lampada da terra con base cromata e paralume in tessuto.  
Adatta per sorgenti luminose a LED con filettatura E27.

### NYC/RON 40/25 DA TERRA

230 V LED E27 11 W

|  |  |                  |
|--|--|------------------|
|  | <b>R14079</b><br>policotone bianco/cromo           | € 188 <b>NEW</b> |
|  | <b>R14080</b><br>Chintz albicocca/cromo            | € 188 <b>NEW</b> |
|  | <b>R14081</b><br>Chintz grigio chiaro/cromo        | € 188 <b>NEW</b> |
|  | <b>R14082</b><br>grigio piccione/PVC argento/cromo | € 248 <b>NEW</b> |
|  | <b>R14083</b><br>Monaco benzina/PVC argento/cromo  | € 248 <b>NEW</b> |
|  | <b>R14084</b><br>policotone nero/cromo             | € 188 <b>NEW</b> |

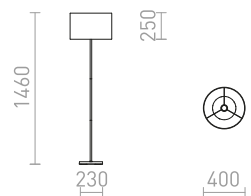



## LULU

Lampada da terra con paralume conico in tessuto e con portalampana E27. La base è una combinazione elegante di parte cromata e colore nero.

### LULU DA TERRA

230 V E27 28 W

**R12466** bianco/nero/cromo

€ 238

**R12467** nero/cromo

€ 238



G13029

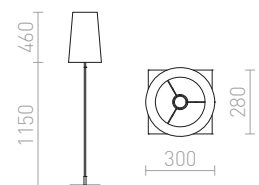



## NYC/CONNY

Lampada da terra con base cromata e paralume in tessuto.  
Adatta per sorgenti luminose a LED con filettatura E27.

### NYC/CONNY 25 DA TERRA

230 V LED E27 7 W

|  |   |       |     |
|--|---|-------|-----|
|  | <b>R14074</b><br>policotone bianco/cromo          | € 178 | NEW |
|  | <b>R14075</b><br>Monaco benzina/PVC argento/cromo | € 229 | NEW |

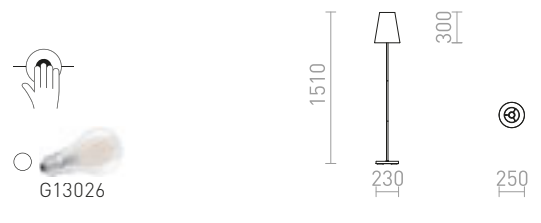

## NYC/CONNY

Lampada da terra con base cromata e paralume in tessuto.  
Adatta per sorgenti luminose a LED con filettatura E27.

### NYC/CONNY 35 DA TERRA

230 V LED E27 11 W

|  |  |       |     |
|--|--|-------|-----|
|  | <b>R14076</b><br>policotone bianco/cromo           | € 198 | NEW |
|  | <b>R14077</b><br>grigio piccione/PVC argento/cromo | € 278 | NEW |
|  | <b>R14078</b><br>Monaco benzina/PVC argento/cromo  | € 278 | NEW |

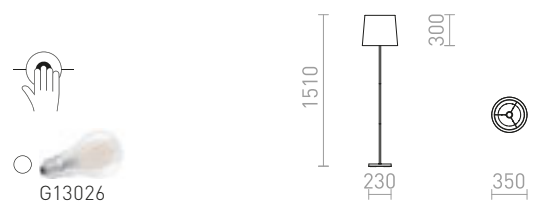



## NYC/TEMPO

Lampada da terra con base cromata e paralume in tessuto. Adatta per sorgenti luminose a LED con filettatura E27.

### NYC/TEMPO 30/19 DA TERRA

230 V LED E27 11 W

R14085 policotone bianco/cromo

€ 188 **NEW**



G13026

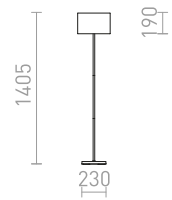

300



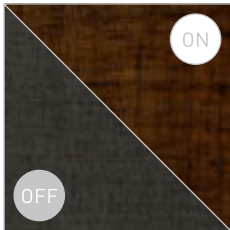
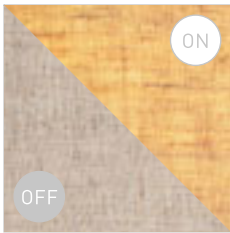

## PERTH

Lampada da terra con paralume tessile quadrato e con piedistallo metallico.

### PERTH DA TERRA

230 V E27 20 W

R13665 beige/bianco

€ 268

R13666 nero/nero

€ 268



G13029

1550



270

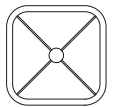

370

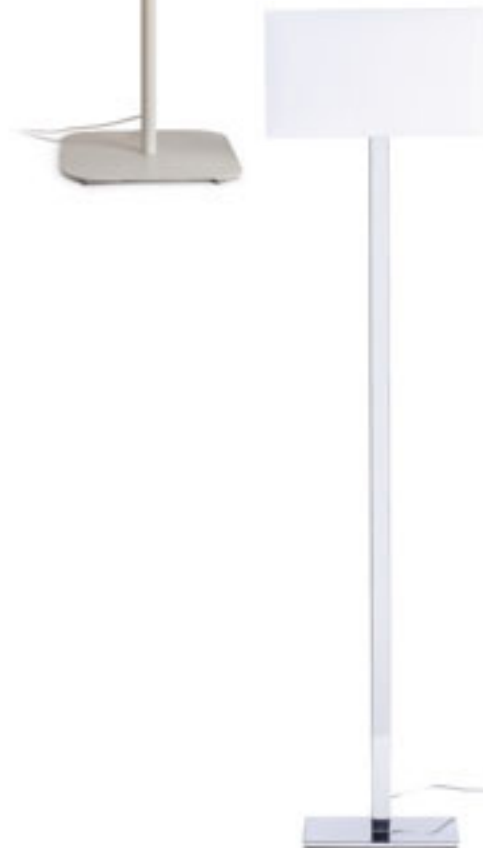

## PLAZA

Lampada da terra con paralume in tessuto strutturato.

### PLAZA DA TERRA

230 V E27 42 W

R11984 bianco/cromo

€ 620



G13026

1400



230

220

400

300x150





## STIG

Elegante lampada a terra a LED di colore nero con snodo in ottone. Tramite l'interruttore sul cavo è possibile impostare tre diverse intensità luminose: 10%, 40% or 100%.

### STIG DA TERRA

230 V LED 8,4 W  $\angle 34^\circ$  3000 K 447 lm Ra 80

R13942 nero

€ 238 **NEW**



LED  
dimmerabile

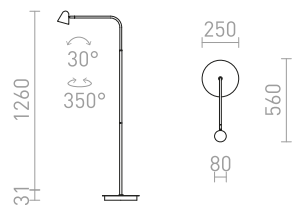

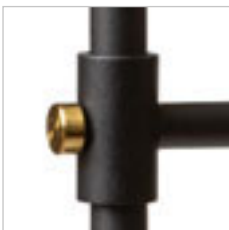

## ROSITA

Lampada da terra in stile retrò per sorgenti luminose di risparmio energetico con portalampada E27.

### ROSITA DA TERRA

230 V E27 12 W

R12514 nero/oro

€ 158 %



G13014

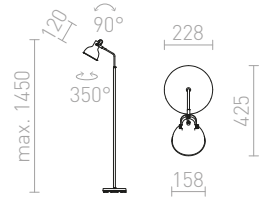

## PRAGMA

Lampada da terra con portalampada E27.

### PRAGMA DA TERRA

230 V E27 28 W

R12989 nero/cromo

€ 150 ▶



G13014

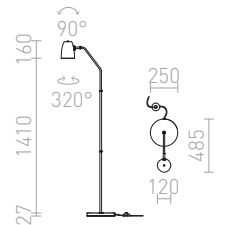

## VARIA

Lampada da terra elegante con riflettore cilindrico per la lampadina LED con portalampada GU10. L'interruttore è posizionato su retro del riflettore.

### VARIA DA TERRA

230 V LED GU10 9 W

R13660 nero/ottone

€ 198



G11841

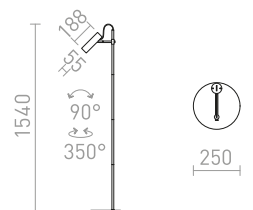



## VIPER

Lampada da terra cromata di design con due riflettori LED neri e scorrevoli, gestiti autonomamente da interruttori posizionati sui cavi di tessuto rosso. Entrambi i cavi hanno il terminale con l'adattatore per la presa.

### VIPER FL

230 V LED 2x3 W  $\angle 60^\circ$  3000 K 200 lm Ra 80

R12463 nero/cromo

€ 248 %

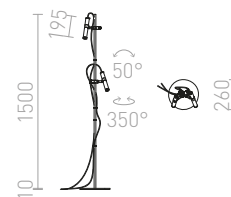

## FADO

Lampada da terra con design quadrato e due riflettori LED orientabili.

### FADO TERRA

230 V LED 2x3 W  $\angle 45^\circ$  3000 K 220 lm Ra 80

R12475 nero

€ 278 %

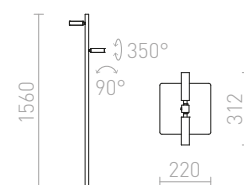

## BUGSY

Lampada da terra con paralumi in vetro a specchio. Ciascun paralume può essere inclinabile su un asse.

### BUGSY DA TERRA

230 V GU10 3x50 W

R10520 vetro cromato

€ 178 %

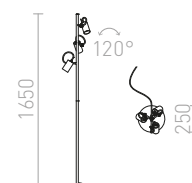

G11841







## LAMPADE DA INCASSO

|                |         |
|----------------|---------|
| COMBINABILI    | 384-389 |
| LED PER BAGNO  | 390-397 |
| PER BAGNO      | 398-405 |
| DECORATIVE     | 406-417 |
| DI GESSO       | 418-427 |
| SENZA CORNICE  | 428-431 |
| SET            | 432-441 |
| CIRCOLARI      | 442-443 |
| QUADRATE       | 444-447 |
| DESIGN SOTTILE | 448-463 |
| DA PARETE      | 464-481 |



## DA INCASSO COMBINABILI



**SHARM BASE**  
384-385



**SHARM PLUS**  
384-385



**SHARM R I**  
386-387

384-389



**SHARM R II**  
386-387



**SHARM R III**  
386-387



**SHARM SQ I**  
388-389



**SHARM SQ II**  
388-389



**SHARM SQ III**  
388-389

## DA INCASSO LED PER BAGNO



**RINO**  
390-391



**WATERBOY R**  
390-391



**WATERBOY SQ**  
390-391

390-397



**NAVY**  
390-391



**INEZ R**  
392-393



**INEZ SQ**  
392-393



**MERGO R**  
392-393



**BELLA LED**  
392-393



**AMIGA R**  
394-395



**AMIGA SQ**  
394-395



**TOLEDO R**  
394-395



**TOLEDO SQ**  
394-395



**OWEN**  
394-395



**BELI R 10**  
396-397



**BELI R 21**  
396-397



**BELI SQ 10**  
396-397



**BELI SQ 21**  
396-397

## DA INCASSO PER BAGNO

398-405



**MAJESTIC**  
398-399



**EQUA**  
398-399



**APRIORI**  
398-399



**BERMUDA**  
398-399



**ACUA**  
400-401



**BELLA GU10**  
400-401



**VERO**  
400-401



**ASTOR SQ**  
402-403



**SPLASH R**  
402-403



**SPLASH SQ**  
402-403



**LEROY R**  
404-405



**LEROY SQ**  
404-405



**INCA R**  
404-405



**ISLA**  
404-405



**BRAN**  
404-405

## DA INCASSO DECORATIVE

406-417



**MARENGA RB1 40**  
406-407



**MARENGA SQB1 40**  
406-407



**MARENGA RR1 40**  
408-409



**MARENGA RR3 60**  
408-409



**MARENGA RR4 90**  
408-409



**MARENGA SQR3 60**  
408-409



**MARENGA RD4 52**  
410-411



**MARENGA RD3 60**  
410-411



**MARENGA RD1 73**  
410-411



**MARENGA RW1 30**  
412-413



**MARENGA RT1 40**  
412-413



**MARENGA RL1 40**  
412-413



**MARENGA RD5 28**  
414-415



**MARENGA RD6 96**  
414-415



**MARENGA RC1 98**  
414-415



**MARENGA RW2 60**  
414-415



**KAY SQ**  
416-417



**KAY R**  
416-417



**BIANCA SQ**  
416-417

## DA INCASSO DI GESSO



**DAG R 83**  
418-419



**DANDY R**  
418-419



**QUO R**  
418-419



**QUO R II**  
418-419



**DANDY SQ**  
420-421



**QUO SQ I**  
420-421



**QUO SQ II**  
420-421



**DINGO S**  
422-423



**DINGO GU10 II**  
422-423



**DINGO R**  
424-425



**DINGO II**  
424-425



**DINGO TUB**  
426-427



**DINO SQ G53**  
426-427



**DINO SQ GU10**  
426-427



**DAN SQ 80**  
426-427



**MIA R**  
426-427



## DA INCASSO SENZA CORNICE



**IPSO SQ frameless**  
428-429



**IPSO R frameless**  
428-429



**IPSO R**  
428-429

428-431



**COIMBRA**  
428-429



**ELECTRA I**  
430-431



**ELECTRA I**  
430-431



**ELECTRA II**  
430-431

## DA INCASSO SET

432-441



**ZIZI I**  
432-433



**ZIZI II**  
432-433



**KELLY LED**  
432-433



**KELLY LED**  
432-433



**SPRAY 9**  
434-435



**SPRAY 11**  
434-435



**GRANADA SQ**  
434-435



**PASADENA G53 R I**  
436-437



**PASADENA G53 SQ I**  
436-437



**PASADENA G53 SQ II**  
436-437



**PASADENA GU10 SQ I**  
436-437



**PASADENA GU10 SQ II**  
436-437



**LIZARD I**  
438-439



**BONDY I**  
438-439



**BONDY II**  
438-439



**BONDY III**  
438-439



**FIZZ III**  
440-441



**MONE I**  
440-441



**MONE II**  
440-441



**MONE III**  
440-441

## DA INCASSO CIRCOLARI

442-443



**VIP**  
442-443



**SOBER**  
442-443



**TOPIC R**  
442-443



**MIRO**  
442-443



**REWA**  
442-443

## DA INCASSO QUADRATE

444-447



**TECH I**  
444-445



**LEDA**  
444-445



**TIM**  
444-445



**MERIKO GU10**  
446-447



**TOPIC SQ**  
446-447



**ACASA**  
446-447



**ZURI SQ**  
446-447



**MURO SQ**  
446-447

## DA INCASSO DESIGN SOTTILE

448-463



**BJORK R 9**  
448-449



**BJORK R 16**  
448-449



**BJORK R 20**  
448-449



**BJORK SQ 9**  
448-449



**BJORK SQ 20**  
448-449



**DADA 9**  
450-451



**DADA 12**  
450-451



**DADA 17**  
450-451



**DADA 23**  
450-451



**DADA 30**  
450-451



**HUE R 9**  
452-453



**HUE R 17**  
452-453



**HUE R 22**  
452-453



**HUE R 9**  
454-455



**HUE R 17**  
454-455



**HUE R 22**  
454-455



**HUE SQ 9**  
456-457



**HUE SQ 17**  
456-457



**HUE SQ 22**  
456-457



**HUE SQ 9**  
458-459

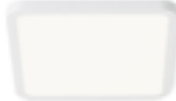

**HUE SQ 17**  
458-459



**HUE SQ 22**  
458-459



**SOCORRO R 85**  
460-461



**SOCORRO R 225**  
460-461



**SLENDER SQ 8**  
460-461



**PESANTE 90**  
462-463



**STRUCTURAL LED 40x40**  
462-463

## DA INCASSO DA PARETE



**IRIA R**  
464-465



**IRIA SQ**  
464-465



**SEGNO**  
464-465

464-481



**ELICA R**  
466-467



**ELICA SQ**  
466-467



**MEMPHIS R**  
466-467



**MEMPHIS SQ**  
466-467



**RIO SQ 0**  
468-469



**RIO R**  
468-469



**RIO SQ**  
468-469



**CLUB IND**  
470-471



**CLUB**  
470-471



**MARCO**  
470-471



**ASTERIA**  
470-471



**KICK I**  
472-473



**KICK II**  
472-473



**KICK III**  
472-473



**AMARO**  
474-475



**TESS SQ**  
474-475



**PER**  
474-475



**INTRO L**  
476-477



**RAGG**  
476-477



**RASQ**  
476-477



**GORDIQ S**  
478-479



**GORDIQ M**  
478-479



**GORDIQ L**  
478-479



**DEJAVU SQ 9**  
480-481



**DEJAVU SQ 14**  
480-481

## SHARM

LED SHARM Sistema Modulare Professionale da incasso - fino a 2500 combinazioni per versioni modulari singole, doppie o triple. Moduli con 5 o 10W. Temperature colore 3000 o 4000K. Lenti con angolo di irradiazione di 12° o 24°. Due tipi di diffusore in 5 colori diversi. Anello ornamentale curvo o piatto in 7 colori e basi circolari o dritte in 3 colori.

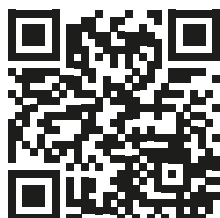

Con questo codice QR potete visitare il nostro sito web, dove potete facilmente e chiaramente impostare il vostro apparecchio a vostro piacimento. Qui potete creare più di 2500 combinazioni di questo apparecchio.









## SHARM

Faretto da incasso non inclinabile con modulo LED di 10W in vari colori.

### SHARM BASE DA INCASSO

230 V LED 10 W  $\angle 24^\circ$  3000 K 900lm Ra 80

|        |              |      |
|--------|--------------|------|
| R13221 | bianco       | € 48 |
| R13222 | oro perlato  | € 48 |
| R13223 | marrone      | € 48 |
| R13224 | nero         | € 48 |
| R13225 | cromo        | € 48 |
| R13226 | rame         | € 48 |
| R13227 | nero cromato | € 48 |

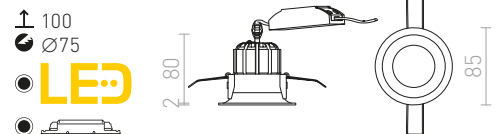

## SHARM

Faretto da incasso non inclinabile con modulo LED di 10W in vari colori.

### SHARM PLUS DA INCASSO

230 V LED 10 W  $\angle 24^\circ$  3000 K 900lm Ra 80

|        |              |      |
|--------|--------------|------|
| R13228 | bianco       | € 48 |
| R13229 | oro perlato  | € 48 |
| R13230 | marrone      | € 48 |
| R13231 | nero         | € 48 |
| R13232 | cromo        | € 48 |
| R13233 | rame         | € 48 |
| R13234 | nero cromato | € 48 |

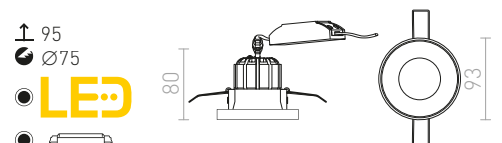





## SHARM

Faretto da incasso non inclinabile con modulo LED di 10W. Con questo codice QR potete visitare il nostro sito web, dove potete facilmente e chiaramente impostare il vostro apparecchio a vostro piacimento. Qui potete creare più di 2500 combinazioni di questo apparecchio.

### SHARM R I DA INCASSO

230 V LED 10 W  $\angle 24^\circ$  3000 K 900 lm Ra 80

|                                   |      |
|-----------------------------------|------|
| <b>R13235</b> bianco/rame         | € 58 |
| <b>R13236</b> oro perlato/marrone | € 58 |
| <b>R13237</b> marrone/oro perlato | € 58 |
| <b>R13238</b> nero/rame/rame      | € 58 |
| <b>R13239</b> nero/nero/rame      | € 58 |

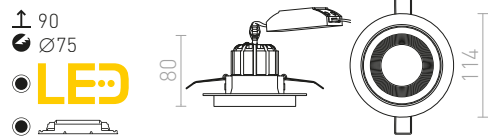

### SHARM R II DA INCASSO

230 V LED 2x10 W  $\angle 24^\circ$  3000 K 1800 lm Ra 80

|                                   |      |
|-----------------------------------|------|
| <b>R13240</b> bianco/rame         | € 98 |
| <b>R13241</b> oro perlato/marrone | € 98 |
| <b>R13242</b> marrone/oro perlato | € 98 |
| <b>R13243</b> nero/rame/rame      | € 98 |
| <b>R13244</b> nero/nero/rame      | € 98 |

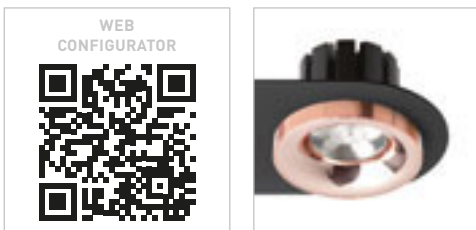
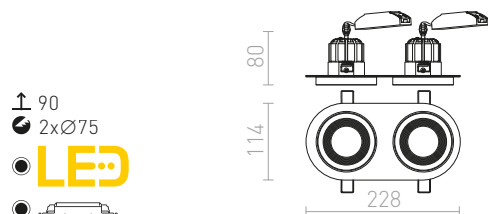



## SHARM

Faretto da incasso non inclinabile con modulo LED di 10W. Con questo codice QR potete visitare il nostro sito web, dove potete facilmente e chiaramente impostare il vostro apparecchio a vostro piacimento. Qui potete creare più di 2500 combinazioni di questo apparecchio.

### SHARM R III DA INCASSO

230 V LED 3x10 W  $\angle 24^\circ$  3000 K 2700 lm Ra 80

**R13245** bianco/rame € 138

**R13246** oro perlato/marrone € 138

**R13247** marrone/oro perlato € 138

**R13248** nero/rame/rame € 138

**R13249** nero/nero/rame € 138

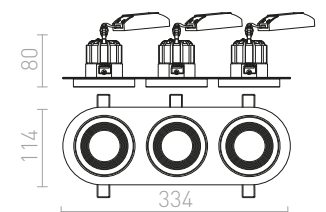
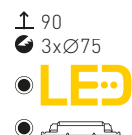
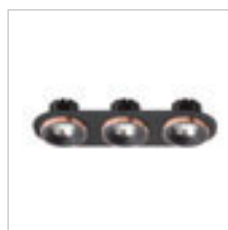
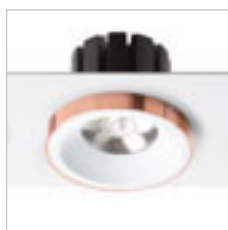





## SHARM

Faretto da incasso non inclinabile con modulo LED di 10W. Con questo codice QR potete visitare il nostro sito web, dove potete facilmente e chiaramente impostare il vostro apparecchio a vostro piacimento. Qui potete creare più di 2500 combinazioni di questo apparecchio.

### SHARM SQ I DA INCASSO

230 V LED 10 W  $\angle 24^\circ$  3000 K 900 lm Ra 80

|                                   |      |
|-----------------------------------|------|
| <b>R13250</b> bianco/rame         | € 58 |
| <b>R13251</b> oro perlato/marrone | € 58 |
| <b>R13252</b> marrone/oro perlato | € 58 |
| <b>R13253</b> nero/rame/rame      | € 58 |
| <b>R13254</b> nero/nero/rame      | € 58 |

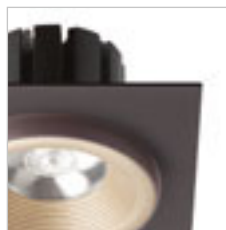
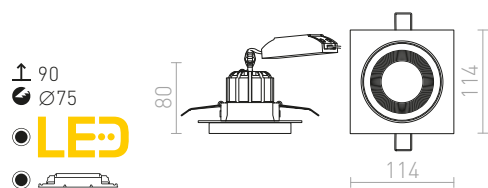

WEB  
CONFIGURATOR

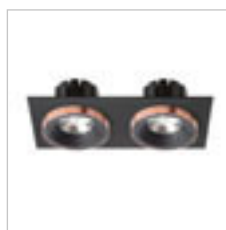

### SHARM SQ II DA INCASSO

230 V LED 2x10 W  $\angle 24^\circ$  3000 K 1800 lm Ra 80

|                                   |      |
|-----------------------------------|------|
| <b>R13255</b> bianco/rame         | € 98 |
| <b>R13256</b> oro perlato/marrone | € 98 |
| <b>R13257</b> marrone/oro perlato | € 98 |
| <b>R13258</b> nero/rame/rame      | € 98 |
| <b>R13259</b> nero/nero/rame      | € 98 |

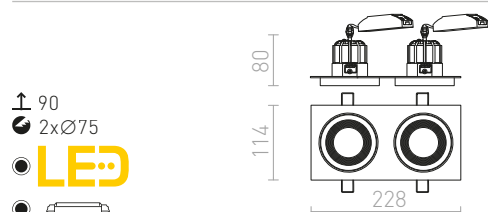



## SHARM

Faretto da incasso non inclinabile con modulo LED di 10W. Con questo codice QR potete visitare il nostro sito web, dove potete facilmente e chiaramente impostare il vostro apparecchio a vostro piacimento. Qui potete creare più di 2500 combinazioni di questo apparecchio.

### SHARM SQ III DA INCASSO

230 V LED 3x10 W  $\angle 24^\circ$  3000 K 2700 lm Ra 80

|                                   |       |
|-----------------------------------|-------|
| <b>R13260</b> bianco/rame         | € 138 |
| <b>R13261</b> oro perlato/marrone | € 138 |
| <b>R13262</b> marrone/oro perlato | € 138 |
| <b>R13263</b> nero/rame/rame      | € 150 |
| <b>R13264</b> nero/nero/rame      | € 138 |

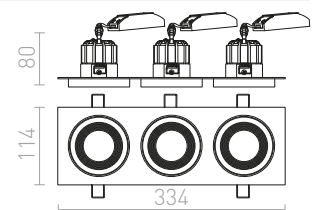
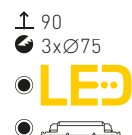



IP65



## NAVY

Faretto robusto da incasso con LED integrato per installazione in controsoffitti esterni.

### NAVY DA INCASSO

230 V LED 15 W  $\angle 36^\circ$  2700 K 1100 lm Ra 80 IP65

R12661 bianco

€ 120

%

↑ 110  
● Ø125

● LED

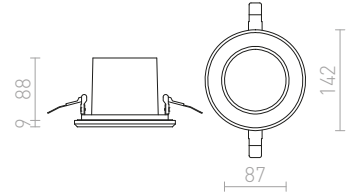

IP65



## RINO

Faretto da incasso in metallo con coperture frontali intercambiabili adatto per ambienti umidi. Copertura da ordinare separatamente.

### RINO DA INCASSO SENZA COPERTURA

230 V LED 10 W  $\angle 36^\circ$  3000 K 760 lm Ra 80 IP65

R11682

€ 38

%

↑ 90  
● Ø70

● LED

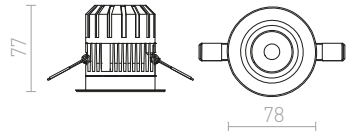

## RINO

Copertura frontale per RINO.

### RINO COPERTURA DECORATIVA

R11683 bianco

€ 9.35

R11684 cromo

€ 11.50

%

R11685 oro

€ 14.50

%

R11686 nichel opaco

€ 11.50

%

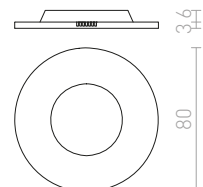

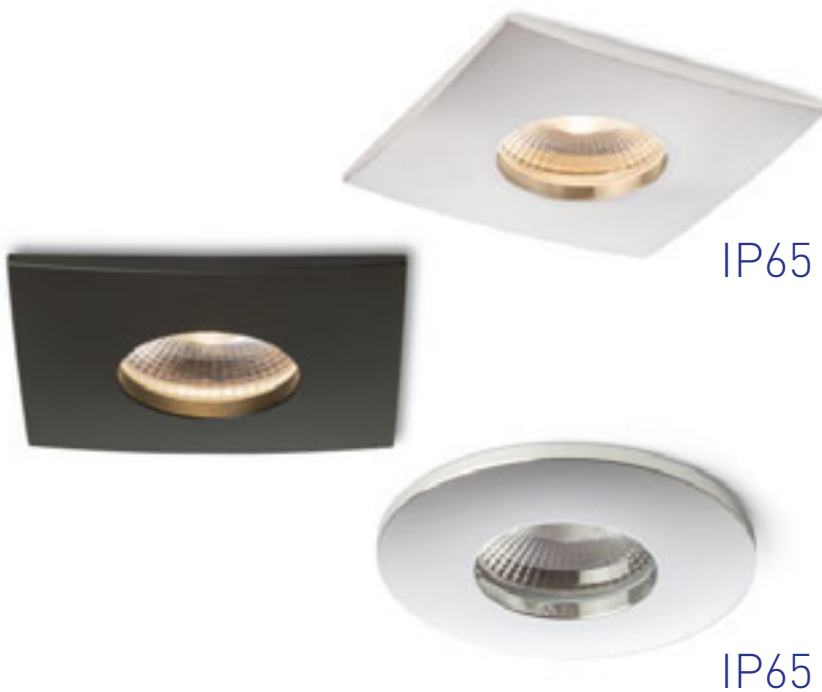

## WATERBOY

Faretto a LED da incasso in alluminio, adatto per ambienti umidi. Disponibile in diverse varianti di colore.

### WATERBOY SQ

230 V LED 10 W  $\angle 40^\circ$  3000 K 550 lm Ra 80 IP65

**R11728** bianco opaco € 78

**R11729** nichel opaco € 78

**R11730** cromo € 78

**R11741** nero opaco € 78

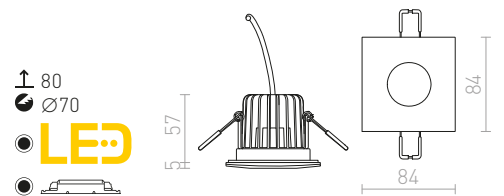

IP65

### WATERBOY R

230 V LED 10 W  $\angle 40^\circ$  3000 K 550 lm Ra 80 IP65

**R11725** bianco opaco € 78

**R11726** nichel opaco € 78

**R11727** cromo € 78

**R11740** nero opaco € 78

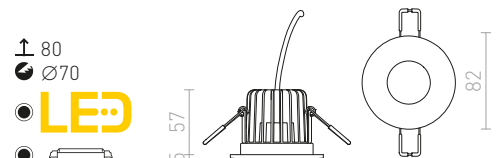





IP65



## BELLA

Faretto da bagno incassato, adatto per soffitti di cartongesso con riflettore incassato.

### BELLA LED DA INCASSO

230 V LED 11 W  $\angle 40^\circ$  3000 K 940 lm Ra 90 IP65

R13602 bianco

€ 68

↑ 70  
● Ø68

● LED

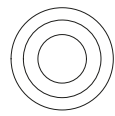
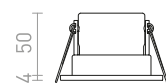

84





IP44



IP44



IP44



### INEZ

Faretto a diodo LED con profondità d'incasso ridotta. Possibile di incassare in mobili.

#### INEZ R

12 V= LED 3 W 3000 K 170 lm Ra 80 IP44

R10586 cromo

€ 35

↑ 15  
● Ø56

● LED

○ G14018

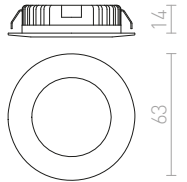

#### INEZ SQ

12 V= LED 3 W 3000 K 170 lm Ra 80 IP44

R10587 cromo

€ 19

↑ 15  
● Ø56

● LED

○ G14018

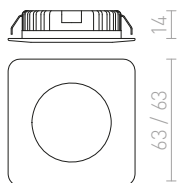

### MERGO

Faretto a LED da incasso con protezione contro l'umidità.

#### MERGO R DA INCASSO

230 V LED 6,5 W 3000 K 535 lm Ra 80 IP44

R10572 cromo

€ 28

↑ 75  
● Ø72

● LED

○ G14018

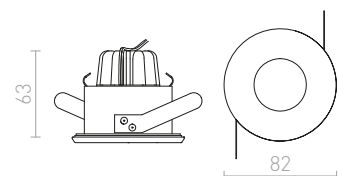



## AMIGA

Apparecchio da incasso con LED integrato, adatto per ambienti umidi. Dimmerazione TRIAC.

### AMIGA R DIMM

230 V LED 8 W  $\angle 40^\circ$  3000 K 580 lm Ra 80 IP65

R10565 bianco

€ 120

- ↑ 110
- Ø96
- LED
- dimmerabile

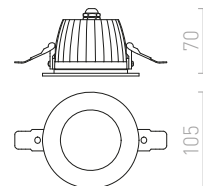

IP65

### AMIGA SQ DIMM

230 V LED 8 W  $\angle 40^\circ$  3000 K 580 lm Ra 80 IP65

R10566 bianco

€ 120

- ↑ 110
- Ø96
- LED
- dimmerabile

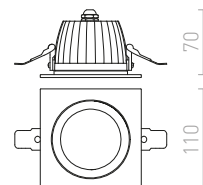

## TOLEDO

Apparecchio da incasso con LED integrato per soffitti in cartongesso. Adatto per ambienti umidi.

### TOLEDO R

230 V LED 7 W  $\angle 60^\circ$  3000 K 514 lm Ra 80 IP44

R12716 bianco

€ 78

- ↑ 70
- Ø70
- LED
- dimmerabile

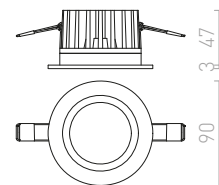

IP44

### TOLEDO SQ

230 V LED 7 W  $\angle 60^\circ$  3000 K 513 lm Ra 80 IP44

R12717 bianco

€ 78

- ↑ 70
- Ø70
- LED
- dimmerabile

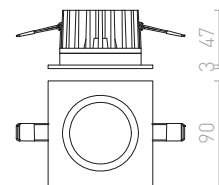



IP54

## OWEN

Lampada da incasso dimmerabile, regolazione del colore e dell'intensità della luce - DIMM TO WARM. Gamma colori nel arco della luce 3000K - 1800K. Montaggio nel controsoffitto in cartongesso. Adatto per ambienti umidi. Dimmerazione TRIAC.

### OWEN DIMM DA INCASSO

230V LED 7W  $\angle 45^\circ$  3000K - 1800K 520lm Ra 90 IP54

R13667 bianco

€ 78

R13668 nero

€ 78

↑ 110  
● Ø55

● LED

● dimmerabile

1800K → 3000K  
DIMM TO WARM

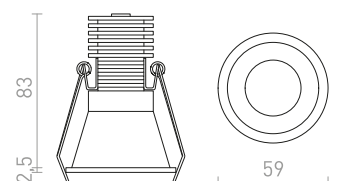





IP65



IP65



### BELI

Lampada da incasso senza cornice. Diffusore di luce in acrilico bianco latte e leggermente staccato dal soffitto. Adatta per ambienti umidi.

#### BELI R 10 DA INCASSO

230 V LED 6 W 3000 K 520 lm Ra 80 IP65

R13430 acrilico

€ 29

↑ 40  
● Ø80

● LED

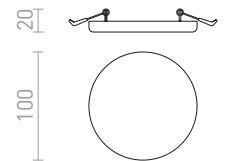

#### BELI R 21 DA INCASSO

230 V LED 24 W 3000 K 2200 lm Ra 80 IP65

R13432 acrilico

€ 68

↑ 40  
● Ø195

● LED

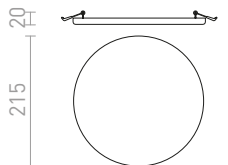

### BELI

Lampada da incasso senza cornice. Diffusore di luce in acrilico bianco latte e leggermente staccato dal soffitto. Adatta per ambienti umidi.

#### BELI SQ 10 DA INCASSO

230 V LED 6 W 3000 K 645 lm Ra 80 IP65

R13521 acrilico

€ 32

↑ 40  
■ 80x80

● LED

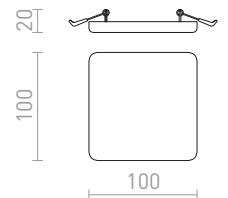

#### BELI SQ 21 DA INCASSO

230 V LED 24 W 3000 K 2299 lm Ra 80 IP65

R13522 acrilico

€ 78

↑ 40  
■ 190x190

● LED

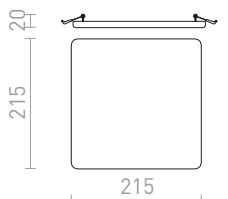





IP54



## EQUA

Faretto da incasso per bagno, in forma circolare, adatto per sorgenti luminose con portalampada GU10. Solo per soffitti di cartongesso.

### EQUA

230 V GU10 35 W IP54

R12746 cromo

€ 11 %

↑ 100  
● Ø75

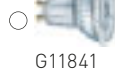

G11841

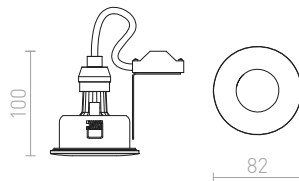

IP54



## APRIORI

Faretto circolare da incasso per sorgenti luminose con portalampada GU10. Solo per soffitti di cartongesso.

### APRIORI

230 V GU10 35 W IP54

R12747 bianco/vetro satinato

€ 22

↑ 140  
● Ø75



G11841

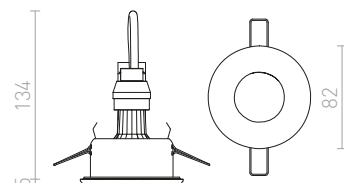

IP44



## MAJESTIC

Apparecchio per bagno da incasso per sorgenti luminose con portalampada GU10. Solo per soffitto di cartongesso.

### MAJESTIC

230 V GU10 35 W IP44

R12911 alluminio spazzolato

€ 26 %

↑ 130  
● Ø65



G11841

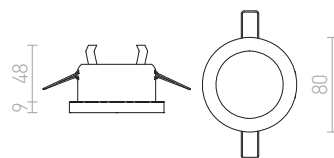



IP65



## BERMUDA

Faretto circolare da incasso, adatto per il bagno e soffitti di cartongesso. Per sorgenti luminosi con portalamпада GU10.

### BERMUDA DA INCASSO

230 V GU10 35 W IP65

R12749 bianco

€ 22

R13604 nero

€ 22

↑ 150  
● Ø75



G11841

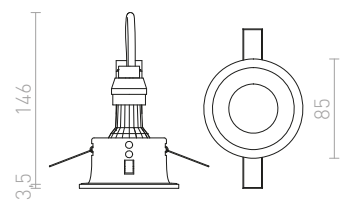



IP44



## VERO

Apparecchio da incasso adatto per ambienti umidi.  
Il vetro di copertura è trasparente con centro satinato.  
È necessario completare con un trasformatore adatto.

**VERO DA INCASSO**  
12V GU5,3 50W IP44

**R10395/12** cromo

€ 38 %

↑ 110  
● Ø95

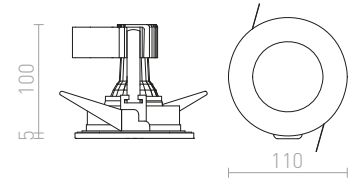

IP44



## VERO

Apparecchio da incasso adatto per ambienti umidi.  
Il vetro di copertura è trasparente con centro satinato.

**VERO DA INCASSO**  
230V GU10 50W IP44

**R10395** cromo

€ 38 %

↑ 110  
● Ø95

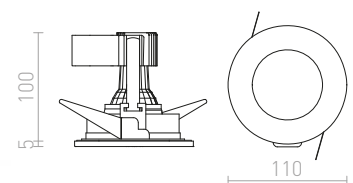



IP65



## BELLA

Faretto da bagno incassato adatto per soffitti di cartongesso con riflettore arrotondato, compatibile con lampadine a LED con portalampada GU10.

### BELLA GU10 DA INCASSO

230 V LED GU10 15 W IP65

|                            |      |
|----------------------------|------|
| <b>R13598</b> bianco       | € 24 |
| <b>R13599</b> nero         | € 24 |
| <b>R13600</b> cromo        | € 28 |
| <b>R13601</b> nichel opaco | € 28 |

↑ 140  
● Ø68

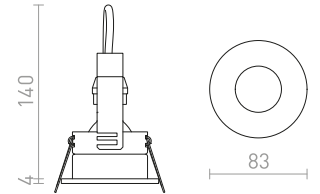

IP44



## ACUA

Apparecchio da incasso adatto per ambienti umidi. Copertura in vetro satinato.

### ACUA DA INCASSO

230 V GU10 50 W IP44

|                      |      |
|----------------------|------|
| <b>R10407</b> bianco | € 18 |
|----------------------|------|

↑ 120  
● Ø85

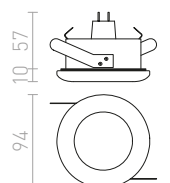





IP65

## SPLASH

Apparecchio da incasso in metallo adatto per ambienti umidi, disponibile in cromo o rifinito in nichel opaco.

### SPLASH R DA INCASSO

230 V GU10 50 W IP65

R11733 cromo

€ 19

R11734 nichel opaco

€ 18.50

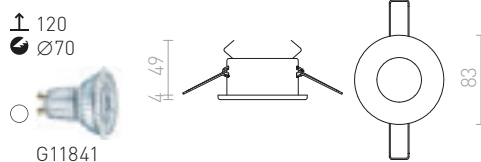

IP65

### SPLASH SQ DA INCASSO

230 V GU10 50 W IP65

R11735 cromo

€ 22

R11736 nichel opaco

€ 22

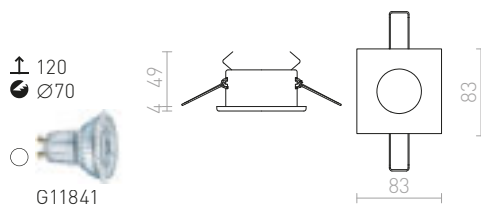





IP65



## ASTOR

Apparecchio da incasso in alluminio spazzolato. Copertura di vetro parzialmente satinata. Adatto per ambienti umidi.

### ASTOR SQ

230 V GU10 50 W IP65

**R10574** alluminio spazzolato

€ 24

↑ 100  
● Ø60



G11841

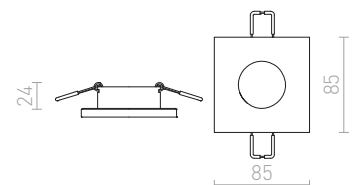



IP65



## INCA

Apparecchio per bagno da incasso circolare, adatto per soffitti di cartongesso per sorgenti luminose a LED con portalampada GU10.

### INCA R

230 V GU10 7 W IP65

R12657 bianco

€ 29

↑ 150  
● Ø70



G11841

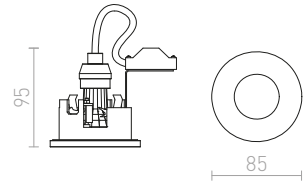

IP65



## BRAN

Lampada da bagno incassata adatta per soffitti di cartongesso, in versione senza cornice, compatibile con lampadine con portalampada GU10.

### BRAN DA INCASSO

230 V LED GU10 15 W IP65

R13605 bianco

€ 28

↑ 140  
● Ø80



G11841

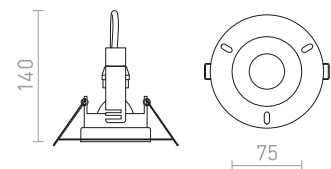

IP65



## ISLA

Lampada da bagno incassata adatta per soffitti di cartongesso con riflettore arrotondato, compatibile con lampadine con portalampada GU10.

### ISLA DA INCASSO

230 V LED GU10 15 W IP65

R13603 bianco

€ 18

↑ 140  
● Ø70



G11841

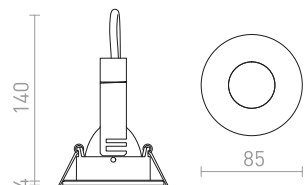



IP44

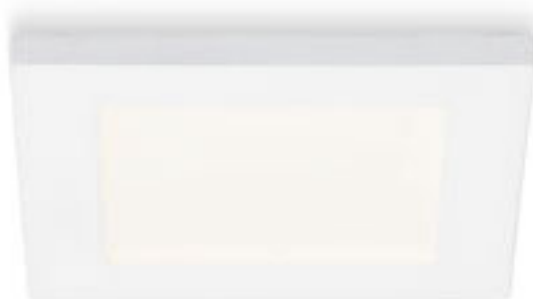

IP44



### LEROY

Apparecchio da incasso per bagno e soffitti di cartongesso e per sorgenti luminose a 12V con portalampana GU5,3.

#### LEROY R

12 V GU5,3 35 W IP44

R12659 bianco

€ 48

↑ 150  
● Ø80

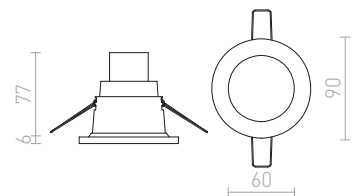
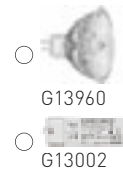

#### LEROY SQ

12 V GU5,3 35 W IP44

R12660 bianco

€ 48

↑ 150  
■ 76x76

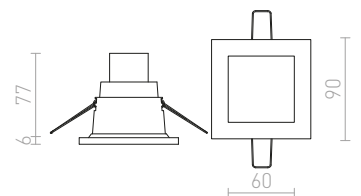
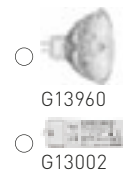







## MARENGA

Apparecchio LED da incasso per cartongesso con profondità di incasso ridotta e con paralume decorativo. Il paralume è realizzato con stampa 3D, in PLA ecologico e completamente degradabile. La dimensione del foro di montaggio può essere selezionata tramite le molle di fissaggio scorrevoli. Gli apparecchi possono sostituire comodamente gli apparecchi alogeni esistenti senza dover modificare i fori di montaggio.

### MARENGA RB1 40 DA INCASSO

230 V LED 6 W 3000 K 570 lm Ra 80

R14011 bianco/Eco PLA

€ 68 **NEW**

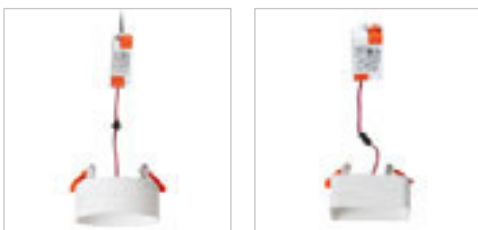
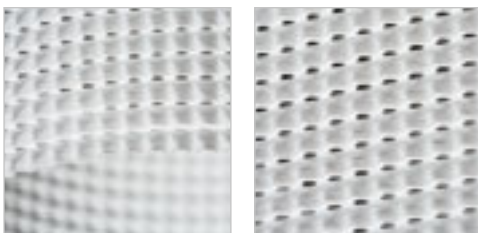
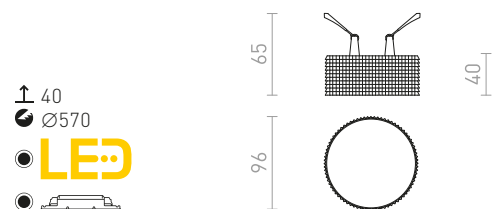

### MARENGA SQB1 40 DA INCASSO

230 V LED 6 W 3000 K 640 lm Ra 80

R14016 bianco/Eco PLA

€ 68 **NEW**

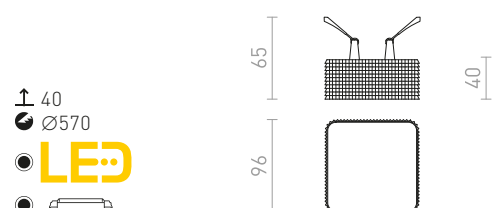





## MARENGA

Apparecchio LED da incasso per cartongesso con profondità di incasso ridotta e con paralume decorativo. Il paralume è realizzato con stampa 3D, in PLA ecologico e completamente degradabile. La dimensione del foro di montaggio può essere selezionata tramite le molle di fissaggio scorrevoli. Gli apparecchi possono sostituire comodamente gli apparecchi alogeni esistenti senza dover modificare i fori di montaggio.

### MARENGA RR1 40 DA INCASSO

230 V LED 6 W 3000 K 570 lm Ra 80

R14002 bianco/Eco PLA

€ 68 **NEW**

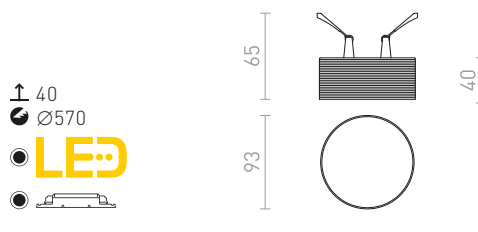

### MARENGA RR3 60 DA INCASSO

230 V LED 6 W 3000 K 570 lm Ra 80

R14003 bianco/Eco PLA

€ 78 **NEW**

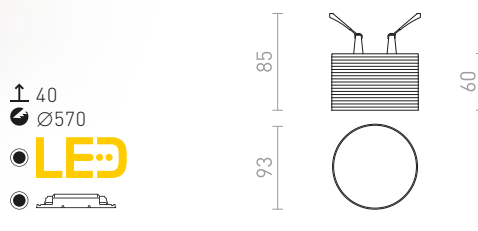

### MARENGA RR4 90 DA INCASSO

230 V LED 6 W 3000 K 570 lm Ra 80

R14004 bianco/Eco PLA

€ 78 **NEW**

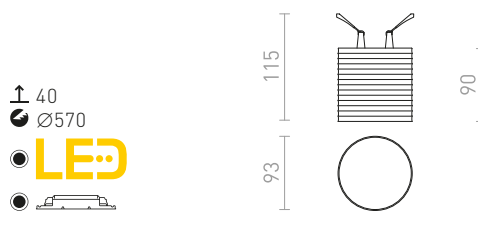

### MARENGA SQR3 60 DA INCASSO

230 V LED 6 W 3000 K 640 lm Ra 80

R14017 bianco/Eco PLA

€ 78 **NEW**

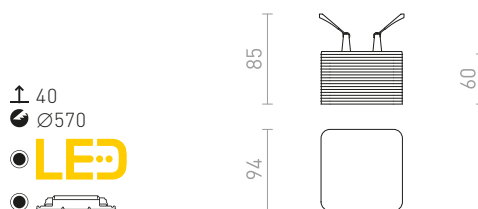

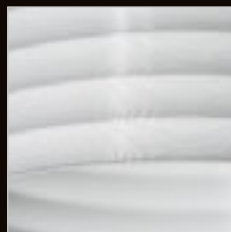
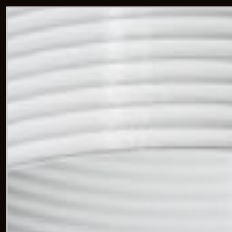





## MARENGA

Apparecchio LED da incasso per cartongesso con profondità di incasso ridotta e con paralume decorativo. Il paralume è realizzato con stampa 3D, in PLA ecologico e completamente degradabile. La dimensione del foro di montaggio può essere selezionata tramite le molle di fissaggio scorrevoli. Gli apparecchi possono sostituire comodamente gli apparecchi alogeni esistenti senza dover modificare i fori di montaggio.

### MARENGA RD4 52 DA INCASSO

230 V LED 6 W 3000 K 570 lm Ra 80

R14007 bianco/Eco PLA

€ 78 **NEW**

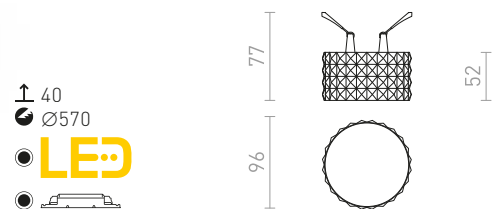

### MARENGA RD3 60 DA INCASSO

230 V LED 6 W 3000 K 570 lm Ra 80

R14008 bianco/Eco PLA

€ 78 **NEW**

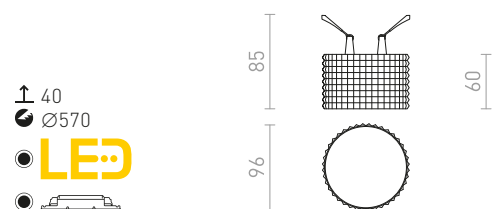

### MARENGA RD1 73 DA INCASSO

230 V LED 6 W 3000 K 570 lm Ra 80

R14009 bianco/Eco PLA

€ 78 **NEW**

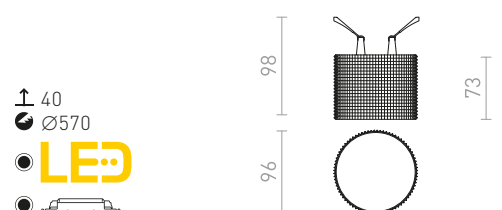

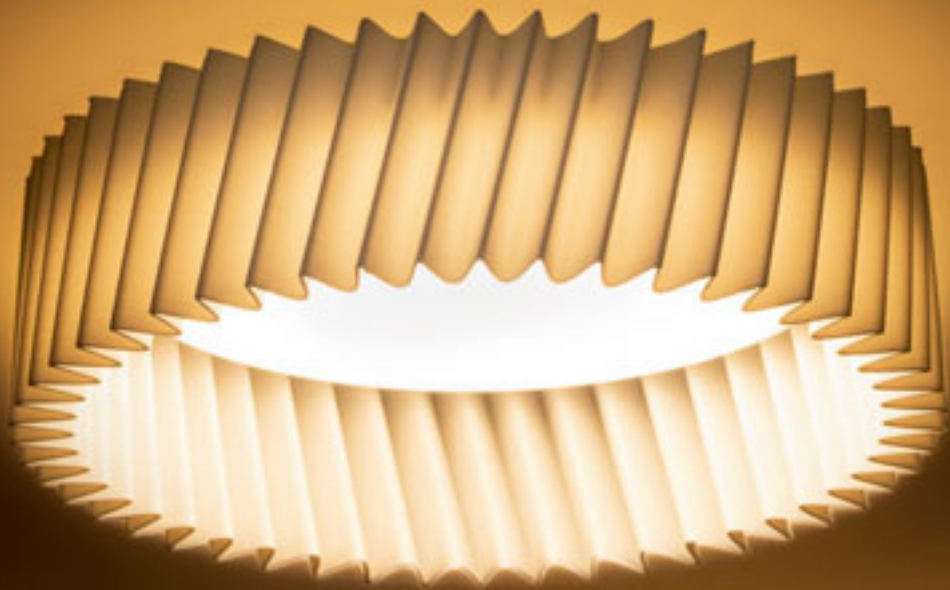



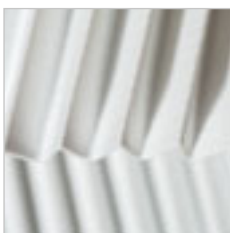

## MARENGA

Apparecchio LED da incasso per cartongesso con profondità di incasso ridotta e con paralume decorativo. Il paralume è realizzato con stampa 3D, in PLA ecologico e completamente degradabile. La dimensione del foro di montaggio può essere selezionata tramite le molle di fissaggio scorrevoli. Gli apparecchi possono sostituire comodamente gli apparecchi alogeni esistenti senza dover modificare i fori di montaggio.

### MARENGA RW1 30 DA INCASSO

230 V LED 6 W 3000 K 570 lm Ra 80

R14013 bianco/Eco PLA

€ 68 **NEW**

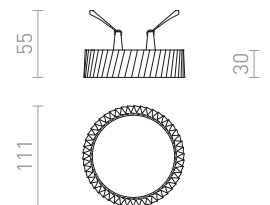
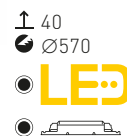

### MARENGA RT1 40 DA INCASSO

230 V LED 6 W 3000 K 570 lm Ra 80

R14012 bianco/Eco PLA

€ 68 **NEW**

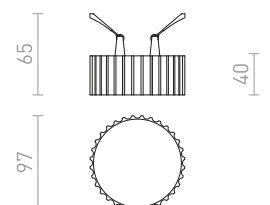
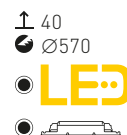

### MARENGA RL1 40 DA INCASSO

230 V LED 6 W 3000 K 570 lm Ra 80

R14005 bianco/Eco PLA

€ 68 **NEW**

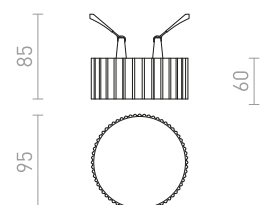
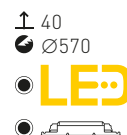

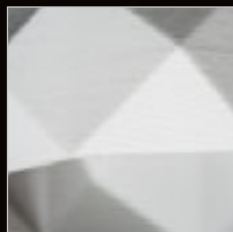



## MARENGA

Apparecchio LED da incasso per cartongesso con profondità di incasso ridotta e con paralume decorativo. Il paralume è realizzato con stampa 3D, in PLA ecologico e completamente degradabile. La dimensione del foro di montaggio può essere selezionata tramite le molle di fissaggio scorrevoli. Gli apparecchi possono sostituire comodamente gli apparecchi alogeni esistenti senza dover modificare i fori di montaggio.

### MARENGA RD5 28 DA INCASSO

230 V LED 6 W 3000 K 570 lm Ra 80

R14006 bianco/Eco PLA

€ 58

NEW

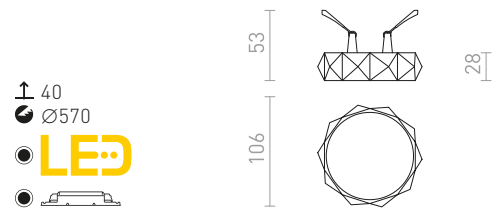

### MARENGA RD6 96 DA INCASSO

230 V LED 6 W 3000 K 570 lm Ra 80

R14010 bianco/Eco PLA

€ 78

NEW

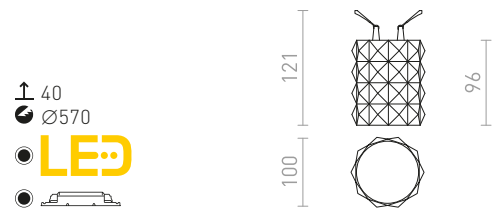

### MARENGA RC1 98 DA INCASSO

230 V LED 6 W 3000 K 570 lm Ra 80

R14015 bianco/Eco PLA

€ 78

NEW

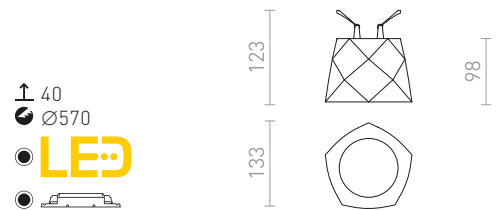

### MARENGA RW2 60 DA INCASSO

230 V LED 6 W 3000 K 570 lm Ra 80

R14014 bianco/Eco PLA

€ 78

NEW

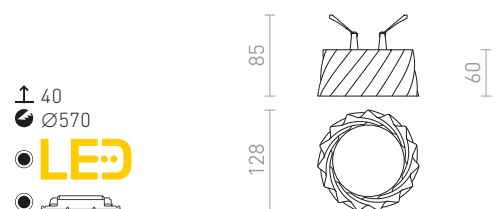





## BIANCA

Apparecchio da incasso in vetro trasparente, satinato o opalino.

### BIANCA SQ DA INCASSO

230 V GU10 50 W

R10304 vetro opalino

€ 28 %

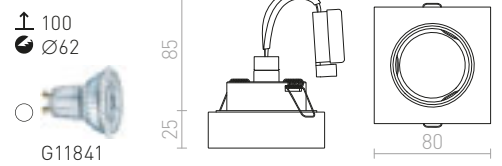

## KAY

Faretto da incasso con copertura in vetro satinato.

### KAY R DA INCASSO

230 V/350 mA LED 5 W 3000 K 450 lm Ra 80

R10419 vetro satinato

€ 22 %

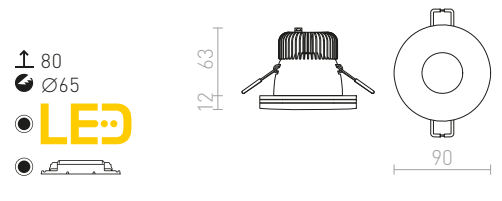

### KAY SQ DA INCASSO

230 V/350 mA LED 5 W 3000 K 450 lm Ra 80

R10418 vetro satinato

€ 22 %

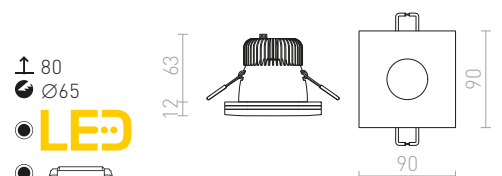





## QUO

Lampade in gesso senza cornice con aperture circolari. L'apparecchio può essere colorato con vernice da interni. Solo per l'installazione nel cartongesso.

### QUO R II DA INCASSO

230 V GU10 2x35 W

R12900 gesso

€ 48

↑ 160  
↙ 80x150



G11841

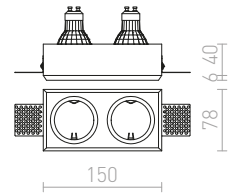

### QUO R DA INCASSO

230 V GU10 35 W

R12361 gesso

€ 22

↑ 150  
↙ 80x80



G11841

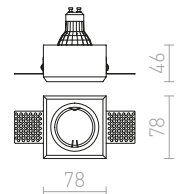

## DAG

Apparecchio da incasso in gesso, in versione senza cornice. Solo per l'installazione nei soffitti di cartongesso.

### DAG R 83 DA INCASSO

230 V GU10 35 W

R12357 gesso

€ 28

↑ 150  
● Ø130



G11841

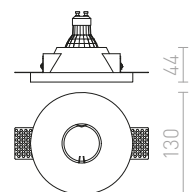



## DANDY

Lampada in gesso da incasso senza cornice per sorgenti luminose con portalampana GU10. Solo per l'installazione nel cartongesso.

### DANDY R DA INCASSO

230 V GU10 35 W

R12362 gesso

€ 18.50



↑ 150  
● Ø100



G11841

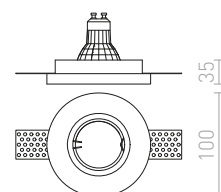



## DAG

Apparecchio da incasso in gesso, in versione senza cornice. Solo per l'installazione nei soffitti di cartongesso.

### DAG SQ DA INCASSO

230 V GU10 35 W

R12355 gesso

€ 24

↑ 150  
120x120



G11841

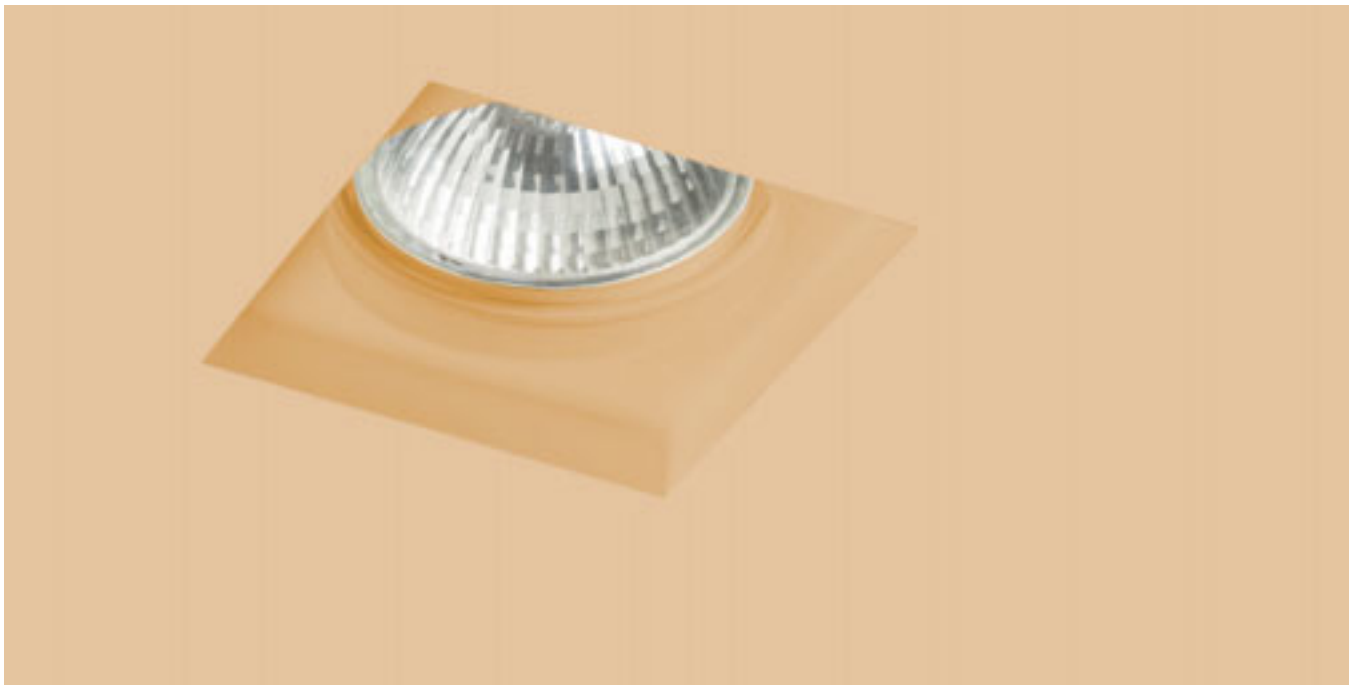
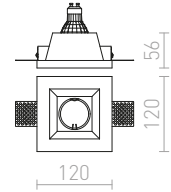

## DANDY

Lampada in gesso da incasso senza cornice per sorgenti luminose con portalampada GU10. Solo per l'installazione nel cartongesso.

### DANDY SQ DA INCASSO

230 V GU10 35 W

R12363 gesso

€ 18.50

↑ 150  
100x100



G11841

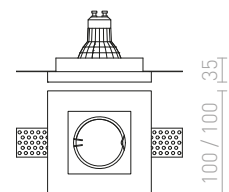



## QUO

Lampade in gesso senza cornice con aperture quadrate. L'apparecchio può essere colorato con vernice da interni. Solo per l'installazione nel cartongesso.

### QUO SQ I DA INCASSO

230 V GU10 35 W

R12360 gesso

€ 22

↑ 150  
80x80



G11841

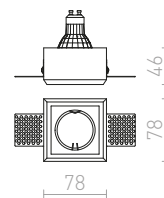

### QUO SQ II DA INCASSO

230 V GU10 2x35 W

R13126 gesso

€ 48

↑ 160  
80x150



G11841

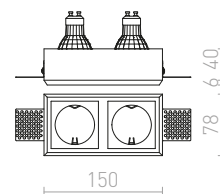







## DINGO

Lampada in gesso da incasso senza cornice.  
L'apparecchio può essere colorato con vernice da interni. Solo per l'installazione nel cartongesso.

**DINGO S FISSO**  
230 V GU10 35 W

**R12358** gesso

€ 24

↑ 150  
120x120



## DINGO S INCLINABILE

12 V GU5,3 50 W

**R10271** gesso

€ 68

↑ 150  
Ø157



## DINGO GU10 II INCLINABILE

230 V GU10 2x35 W

**R12037** gesso

€ 120

↑ 150  
257x157





## DINGO

Apparecchio da incasso circolare in gesso e senza cornice. L'apparecchio può essere colorato con vernice da interni. Solo per l'installazione nel cartongesso.

### DINGO R INCLINABILE

12V G53 50W

R10269 gesso

€ 120

↑ 150

● Ø232



G13656



G13002

96

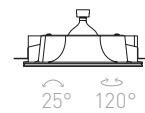

25° 120°

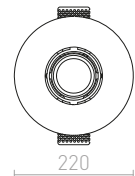

220



## DINGO

Faretto da incasso in gesso e senza cornice con apertura ovale per due sorgenti luminose. L'apparecchio può essere colorato con vernice da interni. Solo per l'installazione nel cartongesso.

### DINGO II INCLINABILE

12V G53 2x50W

R10270 gesso

€ 138

↑ 150

■ 408x250



G13656



G13002

110

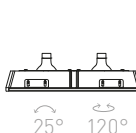

25° 120°

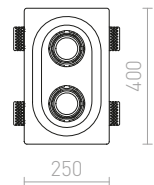

250

400







## DINO SQUARE

Lampada da incasso senza cornice in gesso con apertura quadrata. L'apparecchio può essere colorato con vernice da interni. Solo per l'installazione nel cartongesso.

### DINO SQ G53 INCLINABILE

12 V G53 50 W

R10272 gesso

€ 68 %

↑ 150

⚡ 252x252



G13656



G13002

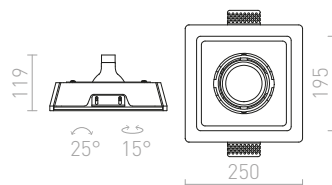

### DINO SQ GU10 INCLINABILE

230 V GU10 35 W

R12038 gesso

€ 78

↑ 150

⚡ 157x157



G11841

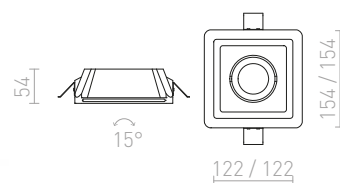

## DAN SQ

Apparecchio da incasso in gesso senza cornice con copertura di vetro satinato. Solo per l'installazioni nel controsoffitto in cartongesso.

### DAN SQ 80 DA INCASSO

230 V GU10 35 W

R12356 gesso

€ 25

↑ 150

⚡ 120x120



G11841

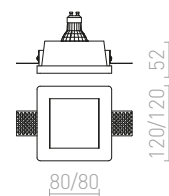



## DINGO

Apparecchio da incasso in gesso con riflettore inclinabile, per sorgenti luminose con portalampada G5,3. Solo per l'installazione nel cartongesso.

### DINGO TUB DA INCASSO

12 V GU5,3 35 W

R12359 gesso

€ 68



↑ 150  
 170x170



G13705



G13002

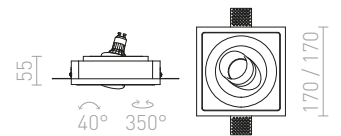

## MIA

Apparecchio da incasso in gesso senza cornice con paralume di policarbonato opaco. Solo per l'installazioni nel controsoffitto in cartongesso.

### MIA R DA INCASSO

230 V E27 2x18 W

R10444 gesso/acrilico satinato

€ 158



↑ 180  
 Ø260



G13155

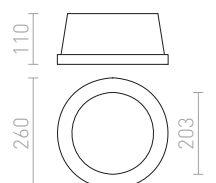





## COIMBRA

Plafoniera circolare da incasso con LED integrato per soffitti di cartongesso. Tramite kit di regolazione di profondità.

### COIMBRA DA INCASSO

230 V LED 24 W 3000 K 1800 lm Ra 80

R12527 nero

€ 88 %



↑ 150  
● Ø450

● LED

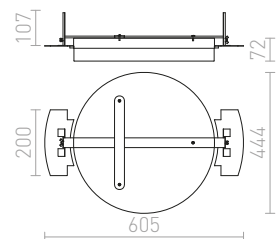



## IPSO

Faretto da incasso senza rivestimento per sorgenti luminose GU10.

### IPSO R FISSO

230 V GU10 35 W

R13288 bianco

€ 24

↑ 150

⊙ Ø85



G11841

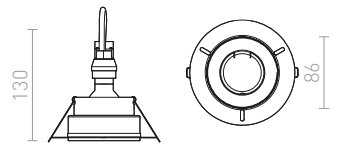

### IPSO R FRAMELESS

230 V GU10 50 W

R12046 bianco

€ 48

↑ 140

⊙ Ø120



G11841

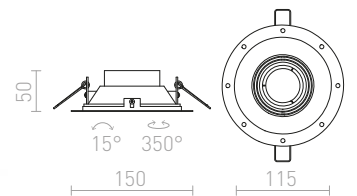

### IPSO SQ FRAMELESS

230 V GU10 50 W

R12045 bianco

€ 48

↑ 140

⊠ 120x120



G11841

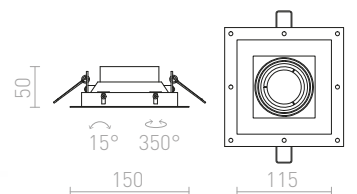



## ELECTRA

Apparecchio da incasso senza cornice con posizione di sorgente luminosa cardanica. Adatto per sorgenti luminose con portalampada GU10.

### ELECTRA I

230 V GU10 50 W

R12052 nero

€ 78

↑ 140  
 108x108



G11841

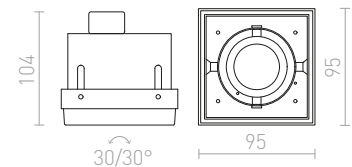

### ELECTRA II

230 V GU10 2x50 W

R12053 nero

€ 129

↑ 140  
 213x108



G11841

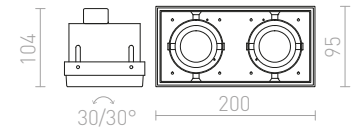



## ELECTRA

Apparecchio da incasso senza cornice con posizione di sorgente luminosa cardanica. Adatto per sorgenti luminose 12V con portalampada G53. Fornito senza trasformatore.

**ELECTRA I**  
12 V G53 50 W

**R12050** nero

€ 120 ➔



↑ 180  
▣ 170x170



G13656

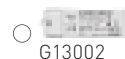

G13002

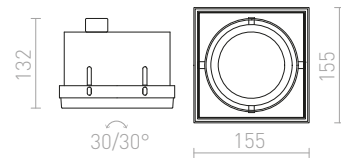



## KELLY LED

Faretto da incasso non inclinabile, con sorgente luminosa a LED integrata. Per l'installazione nel soffitto di cartongesso. Dimmerazione TRIAC.

### KELLY LED DIMM DA INCASSO

230 V LED 15 W  $\angle 45^\circ$  3000 K 750 lm Ra 80

R12635 bianco

€ 98

R12636 nero

€ 98

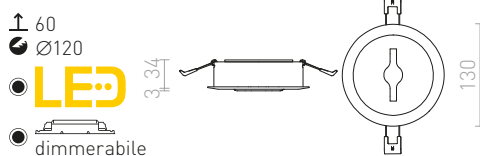

## ZIZI

Apparecchio da incasso in alluminio laccato bianco, con funzione inclinabile, per sorgente luminosa AR111.

### ZIZI I DA INCASSO

12 V G53 50 W

R12695 bianco

€ 35 %

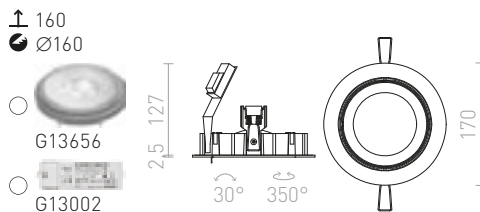

### ZIZI II DA INCASSO

12 V G53 50 W

R12696 bianco

€ 68 %

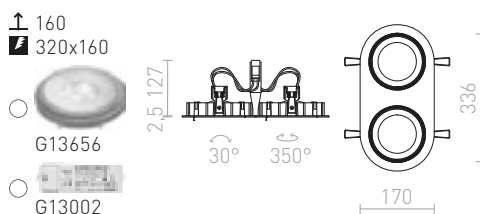





## KELLY LED

Faretto semi-incassato e dimmerabile con riflettore inclinabile a LED integrato. Per l'installazione nel soffitto di cartongesso. Dimmerazione TRIAC.

### KELLY LED DIMM SEMI-INCASSO

230 V LED 12 W  $\angle 24^\circ$  3000 K 600 lm Ra 80

R12637 bianco

€ 98

R12638 nero

€ 98

↑ 50  
 ⌀65

LED

● dimmerabile

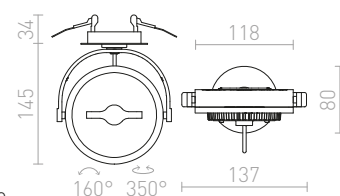



## GRANADA

Lampada da incasso in alluminio massiccio laccato, possibilità di inclinazione, per sorgente luminosa AR111.

### GRANADA SQ

12V G53 50W

R12707 bianco

€ 32 %

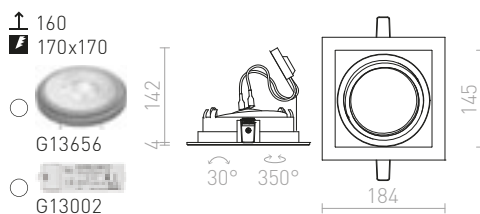

## SPRAY

Faretto da incasso a LED, per l'installazione nel controsoffitto di cartongesso.

### SPRAY 11 DA INCASSO

230V LED 9W  $\angle 24^\circ$  3000K 1250lm Ra 90

R13302 nero

€ 18.50 %

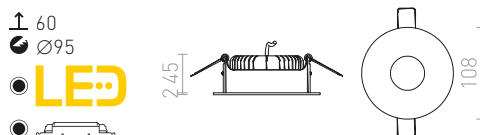

### SPRAY 9 DA INCASSO

230V LED 7W  $\angle 24^\circ$  3000K 880lm Ra 90

R13300 nero

€ 14 %

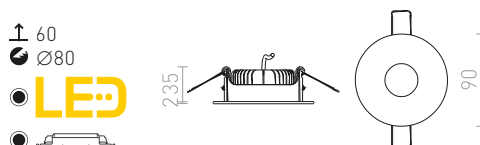





## PASADENA

Apparecchio da incasso in alluminio inclinabile. Disponibile in versione naturale o in due tipi di laccatura, per sorgenti luminose GU10.

### PASADENA GU10 SQ I DA INCASSO

230 V GU10 50 W

**R12709** alluminio spazzolato

€ 22

**R12710** bianco

€ 22

**R12711** nero

€ 22

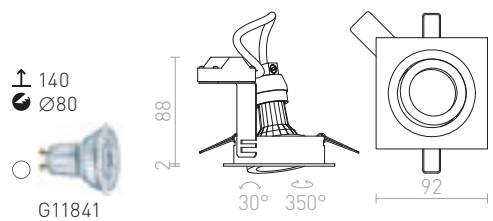

### PASADENA GU10 SQ II DA INCASSO

230 V GU10 2x50 W

**R12712** alluminio spazzolato

€ 29

**R12713** bianco

€ 48

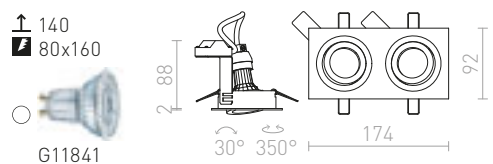





## PASADENA

Apparecchio circolare da incasso in alluminio. Per sorgenti luminose AR111, con la possibilità di inclinazione.

### PASADENA G53 R I

12 V G53 50 W

R12697 bianco

€ 58

R12699 nero

€ 58

↑ 140

⊙ Ø145



G13656



G13002

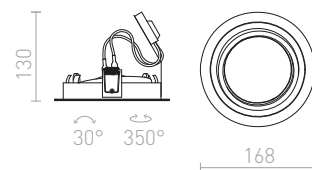

## PASADENA

Apparecchio da incasso in alluminio inclinabile. Per sorgenti luminose AR111.

### PASADENA G53 SQ I

12 V G53 50 W

R12700 bianco

€ 58

R12702 nero

€ 48

↑ 150

⊙ Ø150



G13656



G13002

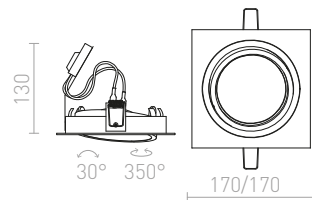

### PASADENA G53 SQ II

12 V G53 2x50 W

R12703 bianco

€ 120

R12704 alluminio spazzolato

€ 120

R12705 nero

€ 88

↑ 150

⊞ 315x150



G13656



G13002

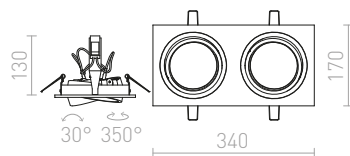





## LIZARD

Mini faretto da incasso a LED. Solo per soffitti in cartongesso.

### LIZARD I DA INCASSO

230 V LED 2 W  $\angle 24^\circ$  3000 K 128 lm Ra 80

R12854 bianco

€ 12 %

↑ 150  
 █ 35x35

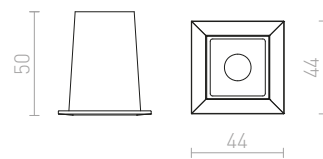

## BONDY

Faretto da incasso a LED. Solo per soffitti in cartongesso.

### BONDY I DA INCASSO

230 V LED 7 W  $\angle 24^\circ$  3000 K 560 lm Ra 80

R12856 bianco

€ 68

↑ 100  
 █ 90x90

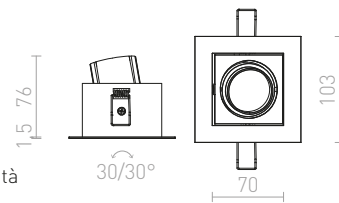

### BONDY II DA INCASSO

230 V LED 2x7 W  $\angle 24^\circ$  3000 K 1120 lm Ra 80

R12857 bianco

€ 88

↑ 100  
 █ 170x90

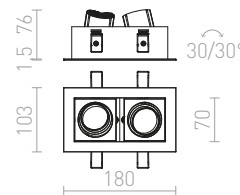

### BONDY III DA INCASSO

230 V LED 3x7 W  $\angle 24^\circ$  3000 K 1680 lm Ra 80

R12858 bianco

€ 88 %

↑ 100  
 █ 243x90

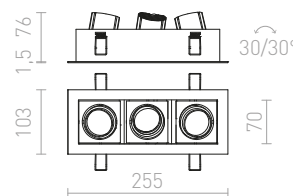





## FIZZ

Apparecchio da incasso con cornice in alluminio. La posizione cardanica permette di inclinare le sorgenti luminose in tutte le direzioni. Solo per l'installazione nel cartongesso.

### FIZZ III INCLINABILE

12V GU5,3 3x50W

R10148 alluminio

€ 58 %

↑ 95

■ 241x88



G13705

83



G13002

45/30°

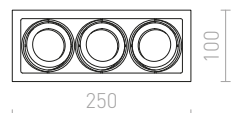



## MONE

Posizione di sorgenti luminose permette a inclinare riflettore in un'asse, cornice in alluminio laccato. Solo per l'installazioni nel cartongesso.

### MONE I RECLINABILE

12 V GU5,3 50 W

R10204 bianco

€ 22 %

↑ 140

▣ 83x85



G13705



G13002

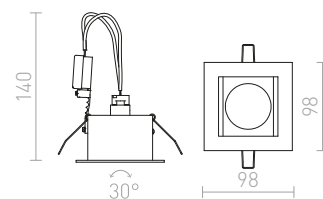

### MONE II RECLINABILE

12 V GU5,3 2x50 W

R10217 grigio argento

€ 29 %

↑ 140

▣ 145x85



G13705



G13002

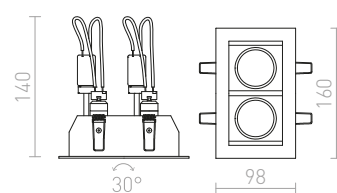

### MONE III RECLINABILE

12 V GU5,3 3x50 W

R10218 grigio argento

€ 32 %

↑ 140

▣ 215x85



G13705



G13002

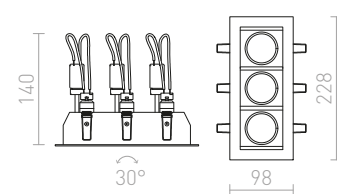





## VIP

Apparecchio circolare inclinabile in metallo.

### VIP RECLINABILE

230 V GU10 50 W

R11746 bianco opaco

€ 16.50

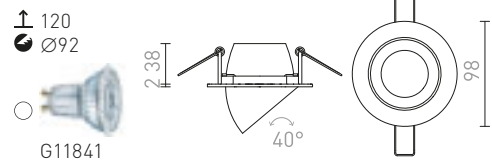

## SOBER

Apparecchio circolare leggermente inclinabile, in metallo laccato bianco con sorgente luminosa da incasso.

### SOBER DA INCASSO

230 V GU10 50 W

R11738 bianco

€ 24

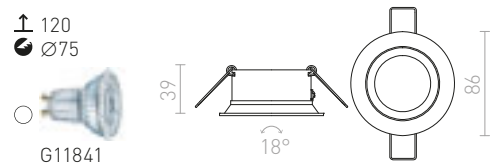





## TOPIC

Lampada da incasso inclinabile in metallo con finitura superficiale in cromo lucido, nichel opaco o rifinitura laccata bianca.

### TOPIC R INCLINABILE

230 V GU10 50 W

**R11731** nichel opaco

€ 6 %

**R11742** cromo

€ 5.80 %

**R11743** bianco opaco

€ 10.50

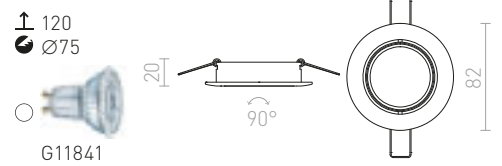

## MIRO

Faretto da incasso inclinabile con LED inetgrato. Driver incluso.

### MIRO DA INCASSO

230 V/350 mA LED 3 W 3000 K 270 lm Ra 80

**R10420** acciaio inossidabile

€ 19.50 %

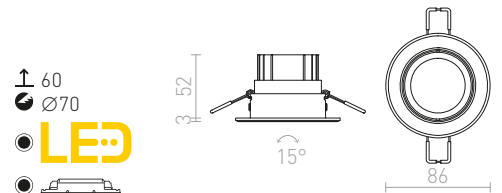

## REWA

Faretto da incasso con montatura solida strutturata.

### REWA FISSO

230 V GU10 50 W

**R10421** cromo

€ 19 ➔

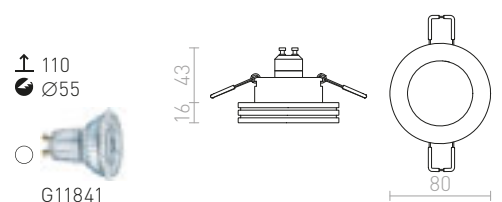





## TECH I

Faretto da incasso non inclinabile con 5,4W LED integrato e copertura in vetro trasparente.

### TECH I FISSO

230 V LED 5,4 W  $\angle 40^\circ$  3000 K 340 lm Ra 80

R10404 bianco

€ 25

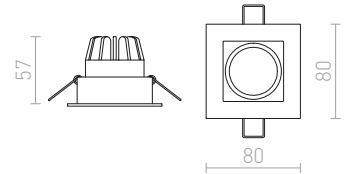
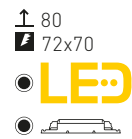

## LEDA

Faretto da incasso con LED cardanico integrato.

### LEDA DA INCASSO

230 V/350 mA LED 5,4 W  $\angle 25^\circ$  3000 K 340 lm Ra 80

R10402 bianco

€ 48

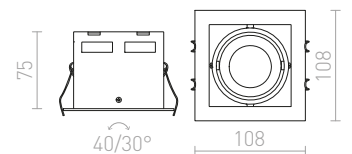
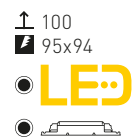

## TIM

Faretto da incasso inclinabile. Driver incluso.

### TIM DA INCASSO

230 V LED 10 W 3000 K 750 lm Ra 80

R12009 bianco

€ 58

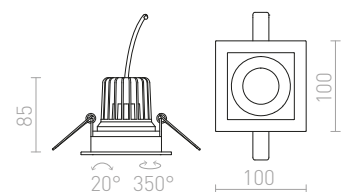
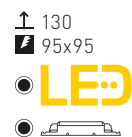



## TOPIC

Lampada da incasso inclinabile in metallo con finitura superficiale in cromo lucido, nichel opaco o rifinitura laccata bianca.

### TOPIC SQ INCLINABILE

230 V GU10 50 W

R11732 nichel opaco

€ 5.35 %

R11744 cromo

€ 5.35 %

R11745 bianco opaco

€ 9.20

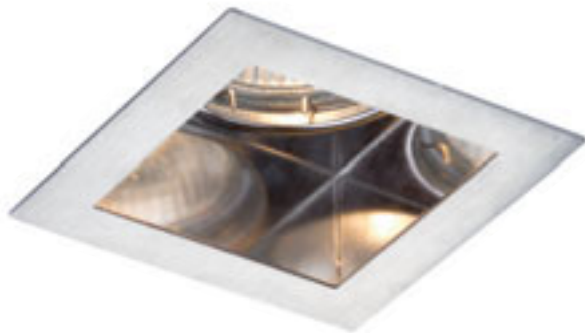
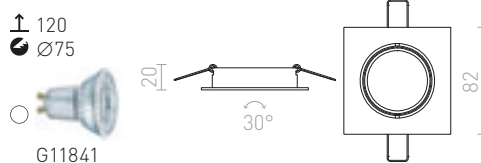

## MERIKO

Cornice in acciaio inossidabile, sorgente luminosa non inclinabile. Solo per l'installazione nel cartongesso.

### MERIKO GU10 FISSO

230 V GU10 50 W

R10219 acciaio inossidabile

€ 18.50 %

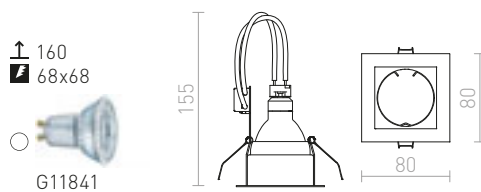

## ZURI

Faretto quadrato da incasso con portalampana GU10. Non inclinabile.

### ZURI SQ DA INCASSO

230 V GU10 35 W

R13391 nero

€ 10.50 %

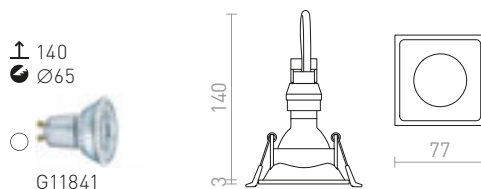



## MURO

Apparecchio da incasso quadrato per soffitti di cartongesso, con funzione inclinabile per sorgenti luminose GU10.

### MURO SQ DA INCASSO

230 V GU10 50 W

R12748 nichel opaco

€ 9.20 %

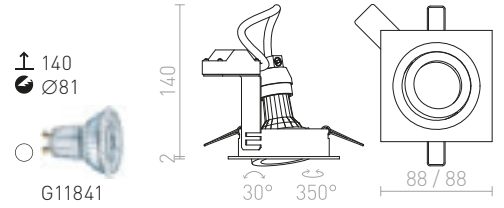

## ACASA

Apparecchio da incasso quadrato inclinabile con portalampana GU10. Per l'installazioni nel soffitto in cartongesso.

### ACASA DA INCASSO

230 V GU10 50 W

R12750 bianco

€ 24

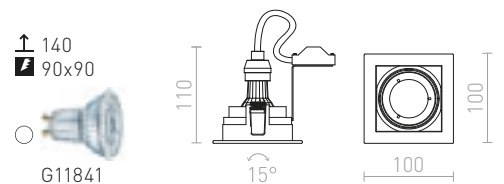



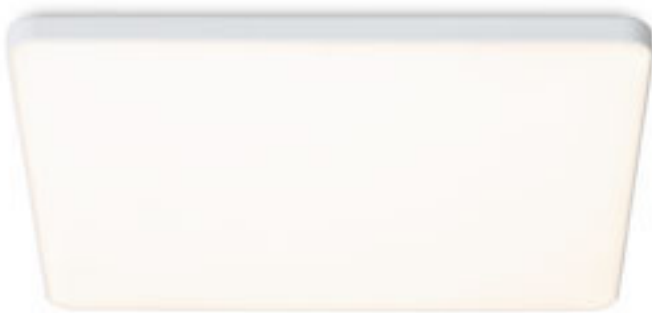

## BJORK

La lampada da incasso LED adatta per controsoffitti di cartongesso con un incasso corto, dispone di cornice di design. Da combinare con plafoniera da soffitto Larisa. La dimensione del foro di montaggio può essere selezionata tramite le molle di fissaggio scorrevoli. Con queste lampade potete comodamente sostituire lampade alogene senza dovere modificare aperture di montaggio.

### BJORK SQ 9 DA INCASSO

230 V LED 6 W 3000 K 640 lm Ra 80

R13588 bianco

€ 26

R13589 nero

€ 26

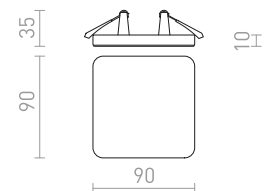

### BJORK SQ 20 DA INCASSO

230 V LED 18 W 3000 K 1800 lm Ra 80

R13590 bianco

€ 58

R13591 nero

€ 58

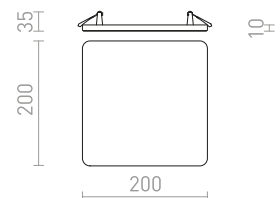
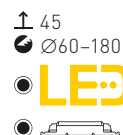



## BJORK

La lampada da incasso LED adatta per controsoffitti di cartongesso con un incasso corto, dispone di cornice di design. Da combinare con plafoniera da soffitto Larisa. La dimensione del foro di montaggio può essere selezionata tramite le molle di fissaggio scorrevoli. Con queste lampade potete comodamente sostituire lampade alogene senza dovere modificare aperture di montaggio.

### BJORK R 9 DA INCASSO

230 V LED 6 W 3000 K 570 lm Ra 80

**R13582** bianco

€ 24

**R13583** nero

€ 24

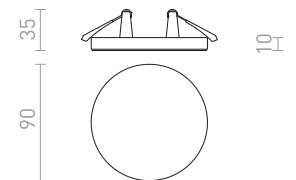

### BJORK R 16 DA INCASSO

230 V LED 12 W 3000 K 1200 lm Ra 80

**R13584** bianco

€ 38

**R13585** nero

€ 38

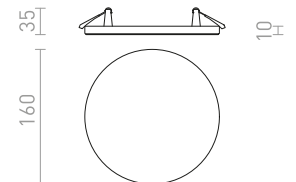
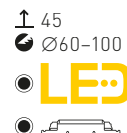

### BJORK R 20 DA INCASSO

230 V LED 18 W 3000 K 1800 lm Ra 80

**R13586** bianco

€ 58

**R13587** nero

€ 58

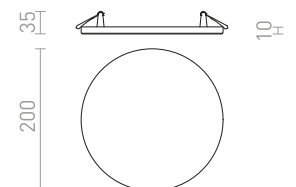
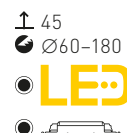



## DADA

Apparecchio da incasso circolare a LED per soffitti in cartongesso, con cornice arrotondata a profondità di incasso ridotta.

### DADA 9 DA INCASSO

230 V LED 3 W 3000 K 180 lm Ra 80

R12870 nero cromato

€ 9.35 %

↑ 60  
● Ø75

● LED

● 

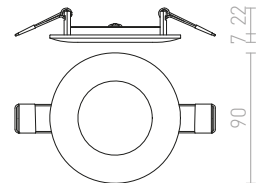

### DADA 12 DA INCASSO

230 V LED 6 W 3000 K 360 lm Ra 80

R12871 bianco

€ 13.50 %

R12872 cromo

€ 15 %

R12875 nero cromato

€ 15 %

↑ 60  
● Ø110

● LED

●  dimmerabilità  
opzionale

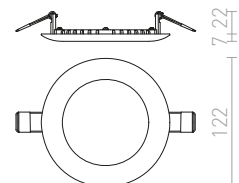



## DADA

Apparecchio da incasso circolare a LED per soffitti in cartongesso, con cornice arrotondata a profondità di incasso ridotta.

### DADA 17 DA INCASSO

230 V LED 12 W 3000 K 720 lm Ra 80

**R12876** bianco € 19 %

**R12877** cromo € 22 %

**R12880** nero cromato € 15.50 %

↑ 60

⊙ Ø160

● LED

● dimmerabilità  
opzionale

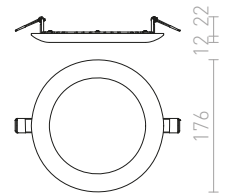

### DADA 23 DA INCASSO

230 V LED 18 W 3000 K 1080 lm Ra 80

**R12881** bianco € 26 %

**R12882** cromo € 13.50 %

**R12884** rame € 24 %

**R12885** nero cromato € 28 %

↑ 100

⊙ Ø210

● LED

● dimmerabilità  
opzionale

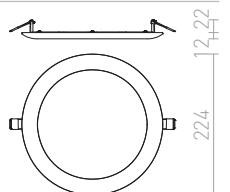

### DADA 30 DA INCASSO

230 V LED 24 W 3000 K 1440 lm Ra 80

**R12886** bianco € 38 %

**R12887** cromo € 26 %

**R12888** oro € 32 %

**R12889** rame € 32 %

**R12890** nero cromato € 26 %

↑ 100

⊙ Ø280

● LED

● dimmerabilità  
opzionale

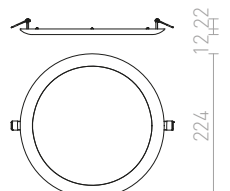



## HUE

Apparecchio da incasso molto sottile con diodi LED ad alta luminosità. Montatura in finiture: cromo, cromo nero, nichel opaco, laccata bianco o nell'imitazione del legno.

### HUE R 9 DA INCASSO

230 V LED 6 W 3000 K 540 lm Ra 80

|                                    |         |   |
|------------------------------------|---------|---|
| <b>R12760</b> bianco               | € 22    | → |
| <b>R12761</b> nero cromato         | € 15.50 | % |
| <b>R12763</b> nichel opaco         | € 15.50 | % |
| <b>R12764</b> imitazione di faggio | € 22    | → |

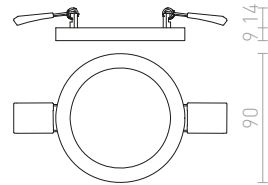

### HUE R 17 DA INCASSO

230 V LED 18 W 3000 K 1620 lm Ra 80

|                                     |      |   |
|-------------------------------------|------|---|
| <b>R12765</b> bianco                | € 48 | → |
| <b>R12766</b> nero cromato          | € 24 | % |
| <b>R12767</b> cromo                 | € 48 | % |
| <b>R12768</b> nichel opaco          | € 35 | % |
| <b>R13401</b> Imitazione noce scuro | € 35 | % |

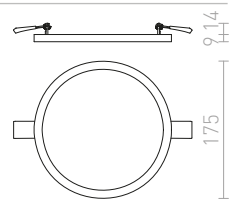
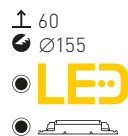

### HUE R 22 DA INCASSO

230 V LED 24 W 3000 K 2160 lm Ra 80

|                                     |      |   |
|-------------------------------------|------|---|
| <b>R12770</b> bianco                | € 68 | → |
| <b>R12771</b> nero cromato          | € 48 | % |
| <b>R12772</b> cromo                 | € 48 | % |
| <b>R12773</b> nichel opaco          | € 48 | % |
| <b>R12774</b> imitazione di faggio  | € 68 | → |
| <b>R13402</b> Imitazione noce scuro | € 58 | % |

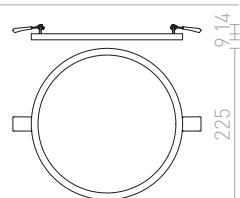
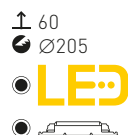









## HUE

Apparecchio da incasso molto sottile con diodo LED ad alta luminosità e dimmerabile. Montatura in finiture: cromo, cromo nero, nichel opaco, laccata bianco o nell'imitazione del legno. Dimmerazione TRIAC.

### HUE R 9 DIMM DA INCASSO

230 V LED 6 W 3000 K 540 lm

|                                    |      |
|------------------------------------|------|
| <b>R13127</b> bianco               | € 58 |
| <b>R13128</b> nero cromato         | € 48 |
| <b>R13130</b> nichel opaco         | € 48 |
| <b>R13131</b> imitazione di faggio | € 58 |

- ↑ 60
- ⊘ Ø70
- LED
- dimmerabile

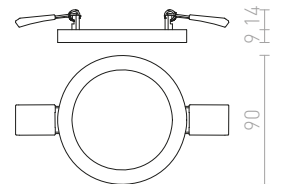

### HUE R 17 DIMM DA INCASSO

230 V LED 18 W 3000 K 1620 lm Ra 80

|                                     |       |
|-------------------------------------|-------|
| <b>R13053</b> bianco                | € 120 |
| <b>R13054</b> nero cromato          | € 88  |
| <b>R13055</b> cromo                 | € 98  |
| <b>R13056</b> nichel opaco          | € 98  |
| <b>R13441</b> Imitazione noce scuro | € 98  |

- ↑ 60
- ⊘ Ø155
- LED
- dimmerabile

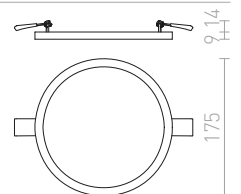

### HUE R 22 DIMM DA INCASSO

230 V LED 24 W 3000 K 2160 lm Ra 80

|                                     |       |
|-------------------------------------|-------|
| <b>R13058</b> bianco                | € 129 |
| <b>R13059</b> nero cromato          | € 120 |
| <b>R13060</b> cromo                 | € 120 |
| <b>R13061</b> nichel opaco          | € 120 |
| <b>R13062</b> imitazione di faggio  | € 120 |
| <b>R13442</b> Imitazione noce scuro | € 120 |

- ↑ 60
- ⊘ Ø205
- LED
- dimmerabile

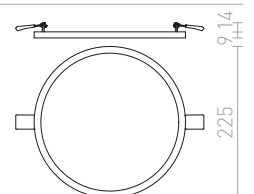

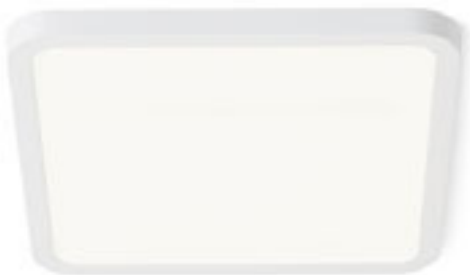

## HUE

Apparecchio da incasso molto sottile con diodi LED ad alta luminosità. Montatura in finiture: cromo, cromo nero, nichel opaco, laccata bianco o nell'imitazione del legno.

### HUE SQ 9 DA INCASSO

230 V LED 6 W 3000 K 540 lm Ra 80

|                            |             |   |
|----------------------------|-------------|---|
| <b>R12775</b> bianco       | <b>€ 19</b> | → |
| <b>R12776</b> nero cromato | <b>€ 16</b> | % |
| <b>R12777</b> cromo        | <b>€ 18</b> | % |
| <b>R12778</b> nichel opaco | <b>€ 16</b> | % |

↑ 60  
70x70

● LED

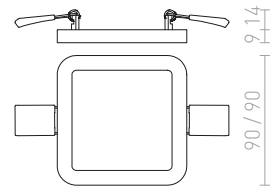
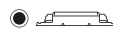

### HUE SQ 17 DA INCASSO

230 V LED 18 W 3000 K 1620 lm Ra 80

|                                    |             |   |
|------------------------------------|-------------|---|
| <b>R12780</b> bianco               | <b>€ 38</b> | % |
| <b>R12781</b> nero cromato         | <b>€ 32</b> | % |
| <b>R12782</b> cromo                | <b>€ 32</b> | % |
| <b>R12783</b> nichel opaco         | <b>€ 32</b> | % |
| <b>R12784</b> imitazione di faggio | <b>€ 35</b> | % |

↑ 60  
155x155

● LED

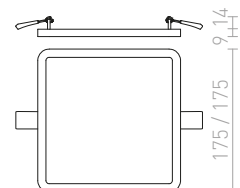

### HUE SQ 22 DA INCASSO

230 V LED 24 W 3000 K 2160 lm Ra 80

|                                    |             |   |
|------------------------------------|-------------|---|
| <b>R12785</b> bianco               | <b>€ 58</b> | % |
| <b>R12786</b> nero cromato         | <b>€ 48</b> | % |
| <b>R12787</b> cromo                | <b>€ 38</b> | % |
| <b>R12788</b> nichel opaco         | <b>€ 38</b> | % |
| <b>R12789</b> imitazione di faggio | <b>€ 38</b> | % |

↑ 60  
205x205

● LED

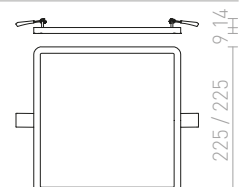











## HUE

Apparecchio da incasso quadrato molto sottile con angoli arrotondati e con diodo LED ad alta luminosità e dimmerabile. Montatura in finiture: cromo, cromo nero, nichel opaco, laccata bianco o nell'imitazione del legno. Dimmerazione TRIAC.

### HUE SQ 9 DIMM DA INCASSO

230 V LED 6 W 3000 K 540 lm Ra 80

- R13132 bianco € 58
- R13133 nero cromato € 48
- R13134 cromo € 58
- R13135 nichel opaco € 58

- ↑ 60
- ▣ 70x70
- LED
- dimmerabile

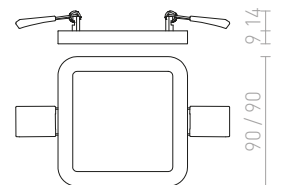

### HUE SQ 17 DIMM DA INCASSO

230 V LED 18 W 3000 K 1620 lm Ra 80

- R13063 bianco € 120
- R13064 nero cromato € 98
- R13065 cromo € 98
- R13066 nichel opaco € 98
- R13067 imitazione di faggio € 98

- ↑ 60
- ▣ 155x155
- LED
- dimmerabile

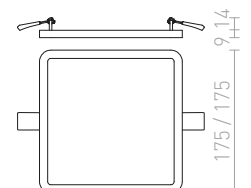

### HUE SQ 22 DIMM DA INCASSO

230 V LED 24 W 3000 K 2160 lm Ra 80

- R13068 bianco € 120
- R13069 nero cromato € 120
- R13070 cromo € 120
- R13071 nichel opaco € 120
- R13072 imitazione di faggio € 120

- ↑ 60
- ▣ 205x205
- LED
- dimmerabile

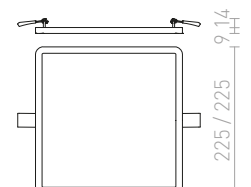



## SLENDER

Apparecchio da incasso molto sottile con LED integrato ad alta luminosità. Driver incluso.

### SLENDER SQ 8 DA INCASSO

230 V LED 3W 3000 K 300 lm Ra 80

**R12186** nero cromato

€ 7.20

%

**R12187** cromo

€ 7.35

%

↑ 50  
 ▣ 65x65

● LED

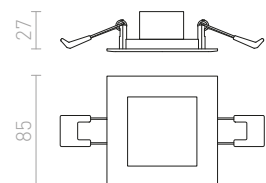



## SOCORRO

Apparecchio da incasso molto sottile con diodo LED ad alta luminosità e cornice in alluminio pressofuso in colore bianco. Driver incluso.

### SOCORRO R 85 DA INCASSO

230 V LED 3 W 3000 K 240 lm Ra 80

R12963 bianco

€ 11

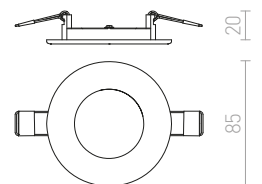
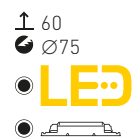

### SOCORRO R 225 DA INCASSO

230 V LED 18 W 3000 K 1440 lm Ra 80

R12965 bianco

€ 32

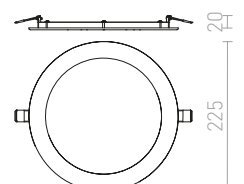





## PESANTE

LED profilo lineare da incasso adatto per soffitti in cartongesso. Adatto per interni moderni.

### PESANTE 90 DA INCASSO

230 V LED 40 W 3000 K 4200 lm Ra 80

R12722 bianco

€ 215

↑ 80

1200x76

LED

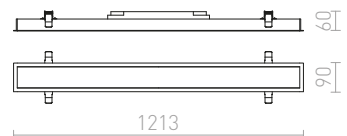





## STRUCTURAL

Apparecchio da incasso a LED integrato con montatura laccata. Driver incluso.

### STRUCTURAL LED 40x40 DA INCASSO

230V LED 40W 3000K 2918lm Ra80

R12062 bianco

€ 178

↑ 60  
 395x395

LED

○ dimmerabilità  
 opzionale

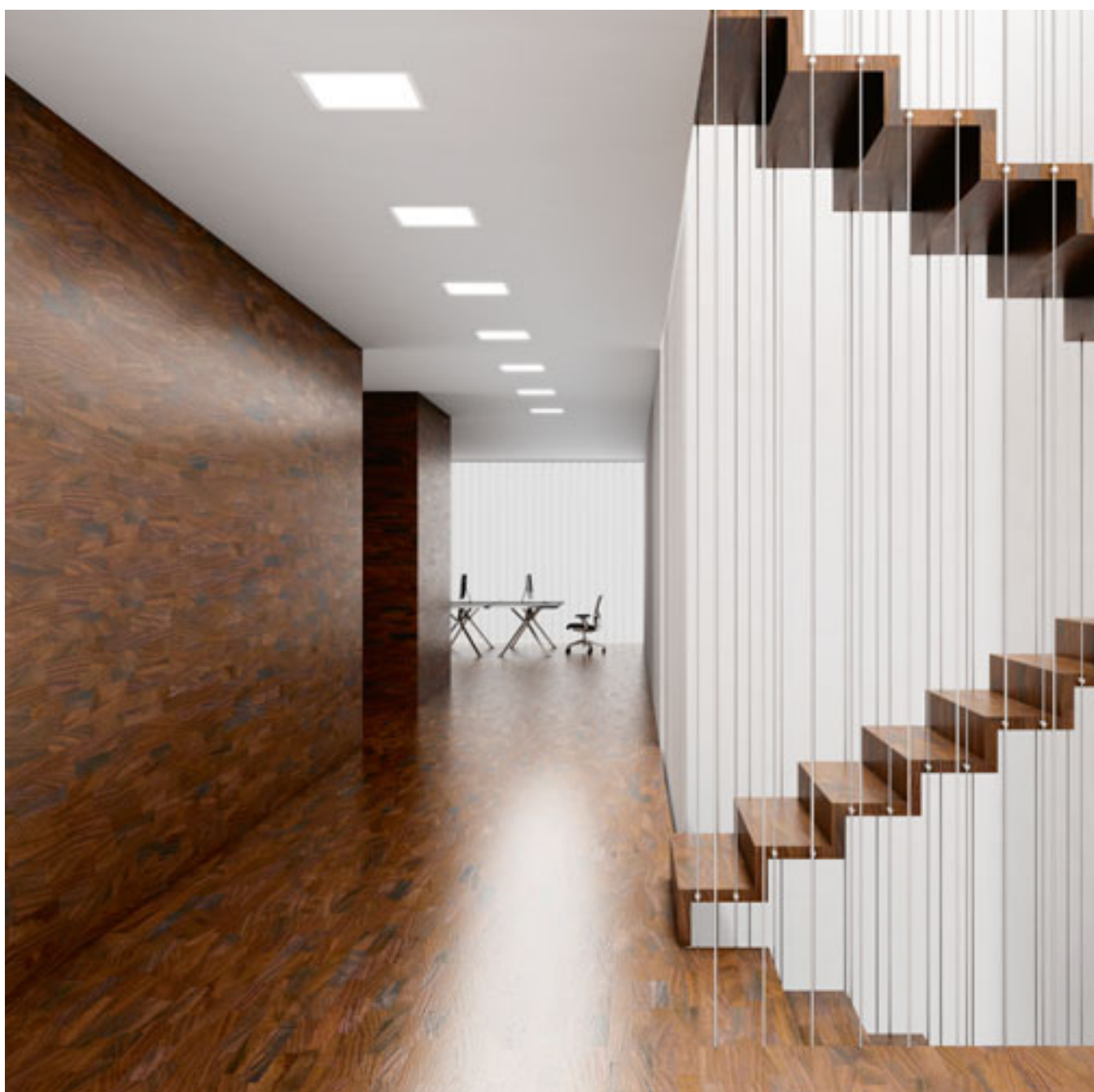
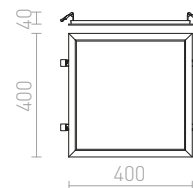



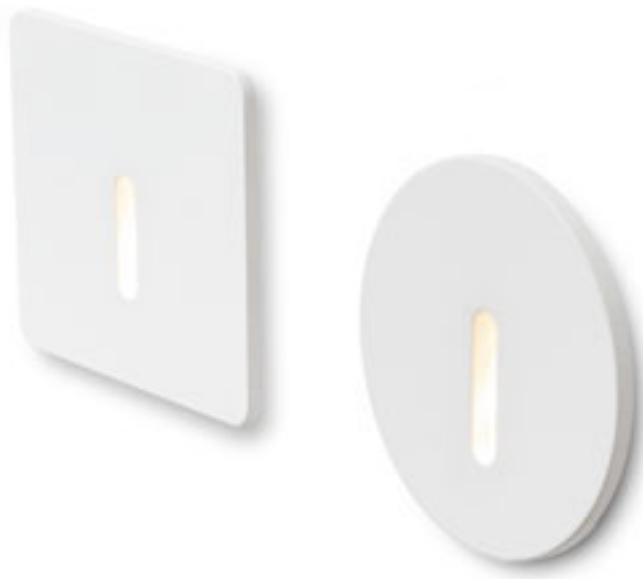

## IRIA

Appliche da incasso a parete a LED con apertura per fascio di luce stretto.

### IRIA R DA INCASSO

230 V LED 3 W  $\angle 10^\circ$  3000 K 390 lm Ra80

R12611 bianco

€ 58

↑ 120  
 ⚡ Ø45



● LED

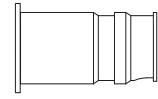

87

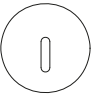

55

### IRIA SQ DA INCASSO

230 V LED 3 W  $\angle 10^\circ$  3000 K 390 lm Ra80

R12612 bianco

€ 58

↑ 120  
 ⚡ Ø45



● LED

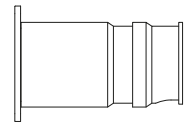

84

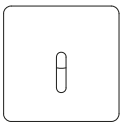

60



IP54

## SEGNO

Appliche da incasso a parete per ambienti esterni con discreta emissione della luce tramite apertura stretta.

### SEGNO DA INCASSO

230 V LED 3 W 3000 K Ra80 IP54

R13566 bianco

€ 98

R13567 grigio antracite

€ 98

↑ 70  
 ⚡ 172x62



● LED

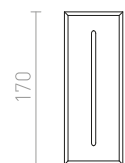

170

65

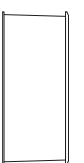

70 3



## MEMPHIS

Lampada da incasso a parete con LED integrato adatta per illuminazione direzionale di corridoi e scale.

### MEMPHIS R DA INCASSO A PARETE

230 V LED 3 W  $\angle 60^\circ$  3000 K 270 lm Ra 80

R12687 grigio argento

€ 35

R13956 bianco

€ 35

NEW

R13957 nero

€ 35

NEW

$\perp$  90

Ø45



LED

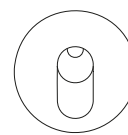
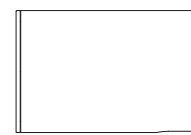

1,5 65 50

### MEMPHIS SQ DA INCASSO A PARETE

230 V LED 3 W  $\angle 60^\circ$  3000 K 270 lm Ra 80

R12688 grigio argento

€ 38

R13954 bianco

€ 38

NEW

R13955 nero

€ 38

NEW

$\perp$  90

Ø40



LED

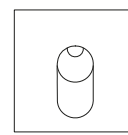

1,5 65 50

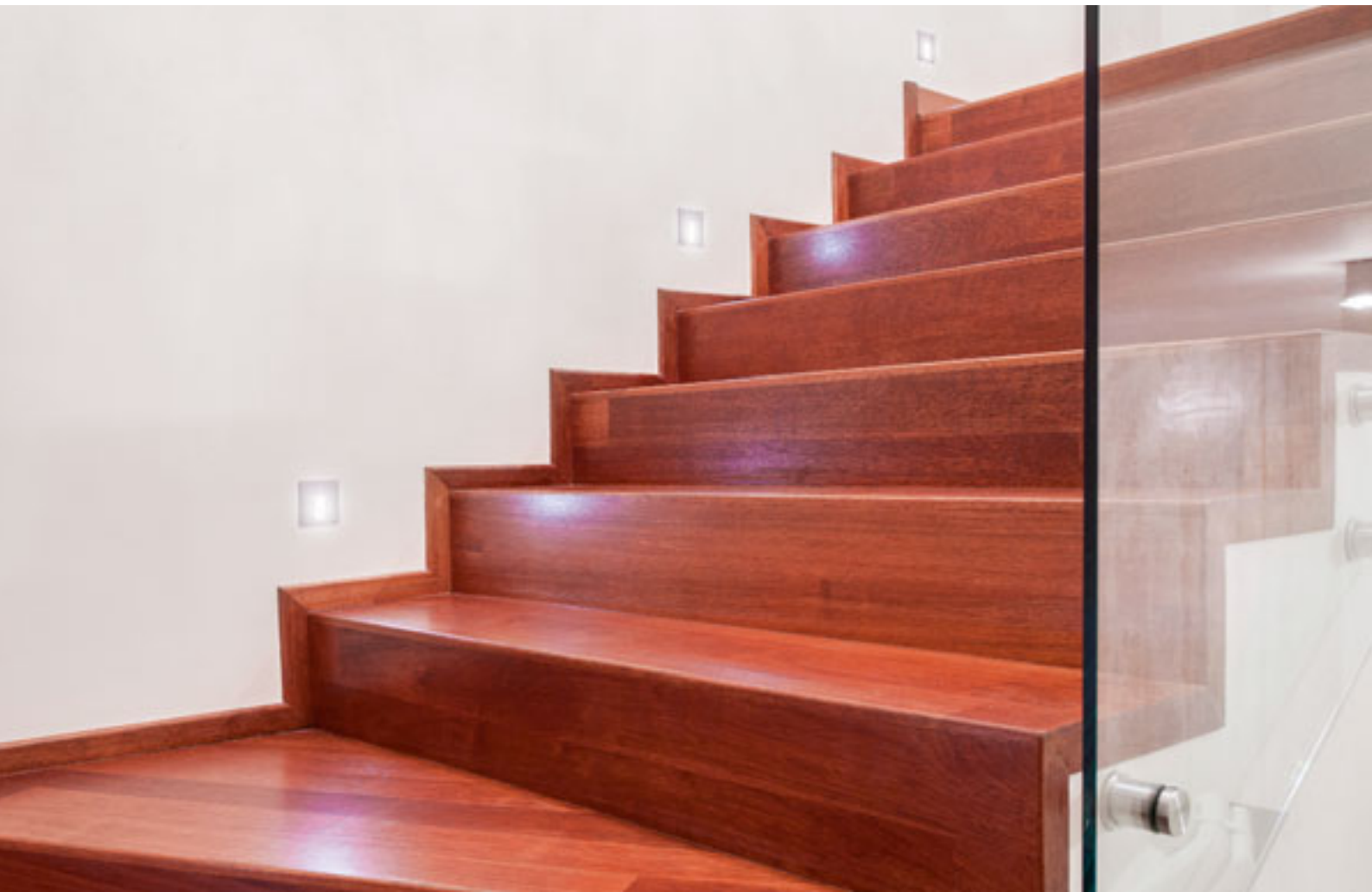

## ELICA

Apparecchio da esterno da incasso a parete con LED integrato e piastra frontale in metallo con orientamento d'illuminazione verso il basso. Scatola di montaggio compresa.

### ELICA R DA INCASSO

230 V LED 3 W 3000 K 75 lm Ra 80 IP54

R12528 alluminio spazzolato

€ 58 %

↑ 95  
⊗ Ø75



● LED

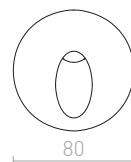
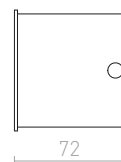

### ELICA SQ DA ESTERNO

230 V LED 3 W 3000 K 180 lm Ra 80 IP54

R10639 nichel opaco

€ 35 %

R12529 alluminio spazzolato

€ 58 %

↑ 70  
⊗ Ø75



● LED

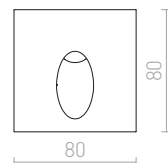
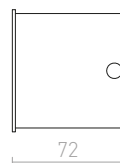







## RIO

Apparecchio da incasso per l'orientamento con LED integrato, per l'installazione nelle pareti cavi o nicchie.

### RIO R DA INCASSO

230 V LED 3 W  $\angle 22^\circ$  3000 K 70 lm Ra 80

R12656 bianco

€ 22

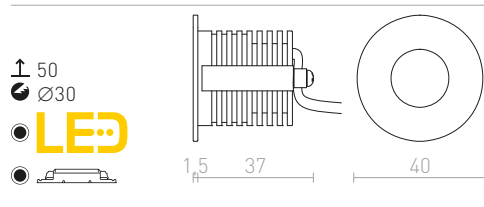

### RIO SQ DA INCASSO

230 V LED 3 W  $\angle 22^\circ$  3000 K 70 lm Ra 80

R12350 bianco

€ 19.50

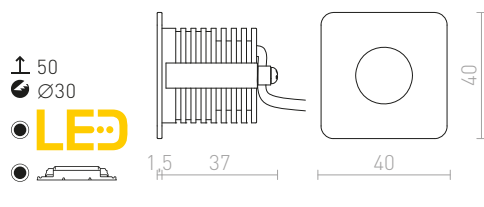

### RIO SQ O DA INCASSO

230 V LED 3 W  $\angle 22^\circ$  3000 K 70 lm Ra 80

R12655 bianco

€ 19.50

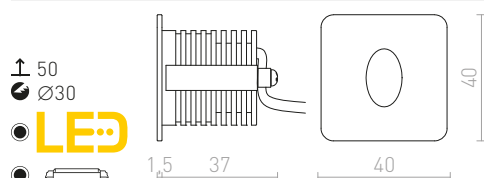





IP54



## MARCO LED

Apparecchio da incasso circolare adatto sia per uso esterno che interno. Solo per illuminazione verso il basso. Scatola di montaggio inclusa.

### MARCO DA INCASSO

230 V LED 3 W 3000 K 80 lm Ra 80 IP54

R12024 bianco

€ 48

R12029 grigio argento

€ 48

R12030 grigio antracite

€ 48

↑ 60  
● Ø76



● LED

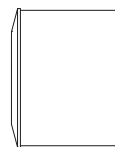

56

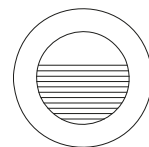

78



IP54

IP54



## CLUB

Lampada da incasso a parete con LED integrato adatta per illuminazione direzionale di corridoi e scale.

### CLUB DA INCASSO

230 V LED 3 W 3000 K 270 lm Ra 80 IP54

R12685 grigio argento

€ 48

↑ 90  
● Ø57

● LED

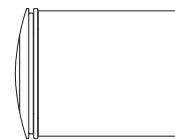

10

65

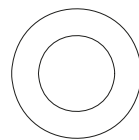

58

### CLUB IND DA INCASSO

230 V LED 3 W 3000 K 270 lm Ra 80 IP54

R12686 grigio argento

€ 48

↑ 90  
● Ø56



● LED

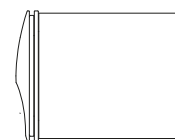

10

65

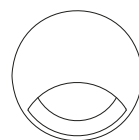

58



IP54



## ASTERIA

Applique da incasso a parete esterna. Montatura visibile con profondità di 3 cm. Da installare solo per illuminazione verso il basso.

### ASTERIA DA INCASSO

230 V LED 3 W 3000 K 180 lm Ra 80 IP54

R10558 grigio argento

€ 58 %

↑ 75

● Ø113



● LED

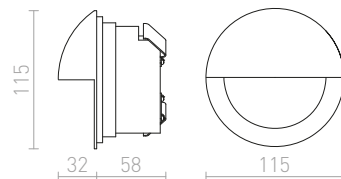







IP54



IP54



IP54

## KICK

Apparecchio di orientamento da incasso con LED integrato, illuminazione verso uno, due o tre lati. Progettato per il montaggio a parete.

### KICK I DA INCASSO

230 V LED 3 W 3000 K 100 lm Ra 80 IP54

R12613 bianco

€ 48

R12615 nero

€ 48

↑ 80

● Ø40

● LED

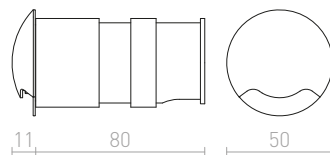

### KICK II DA INCASSO

230 V LED 3 W 3000 K 120 lm Ra 80 IP54

R12616 bianco

€ 48

R12618 nero

€ 48

↑ 80

● Ø40

● LED

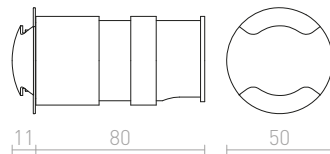

### KICK III DA INCASSO

230 V LED 3 W 3000 K 150 lm Ra 80 IP54

R12619 bianco

€ 48

R12621 nero

€ 48

↑ 80

● Ø40

● LED

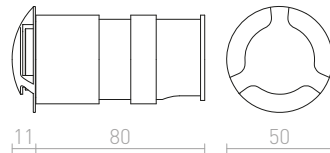



## AMARO

Lampada da incasso a parete con LED integrato adatta per illuminazione direzionale di corridoi e scale.

### AMARO DA INCASSO

230 V LED 3 W  $\angle 60^\circ$  3000 K 270 lm Ra 80

**R12690** bianco

€ 38

**R13958** nero

€ 38

NEW



70

Ø40



LED

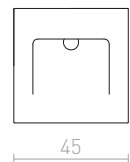
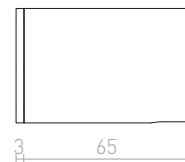



IP54



## PER

Applique da incasso a parete con LED integrato. Per uso esterno e interno come illuminazione direzionale di sentieri, scale o terrazze.

### PER DA INCASSO

230 V LED 3 W 3000 K 76 lm Ra 80 IP54

R12576 bianco

€ 58

R12577 grigio antracite

€ 58

↑ 60

▣ 65x102



LED

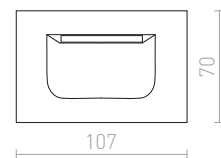

IP54



## TESS

Apparecchio quadrato da incasso a parete per interni ed esterni. Solo per illuminazione verso il basso, disponibile in tre colori. Scatola di montaggio inclusa.

### TESS SQ DA INCASSO

230 V LED 3 W 3000 K 80 lm Ra 80 IP54

R12013 bianco

€ 58

R12014 grigio argento

€ 58

R12015 grigio antracite

€ 58

↑ 70

▣ 60x55



LED

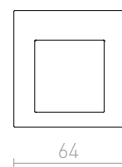
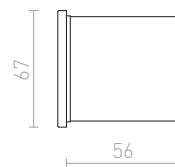



## RAGG

Apparecchio da incasso da esterno con possibilità di orientare l'illuminazione, adatto per illuminare i marciapiedi o le scale.

### RAGG DA INCASSO

230 V LED 12 W 3000 K 406 lm Ra 80 IP65

R13620 bianco

€ 120

R13621 nero

€ 120

↑ 80

↙ 80x230



● LED

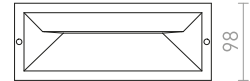
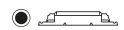

5 85

250

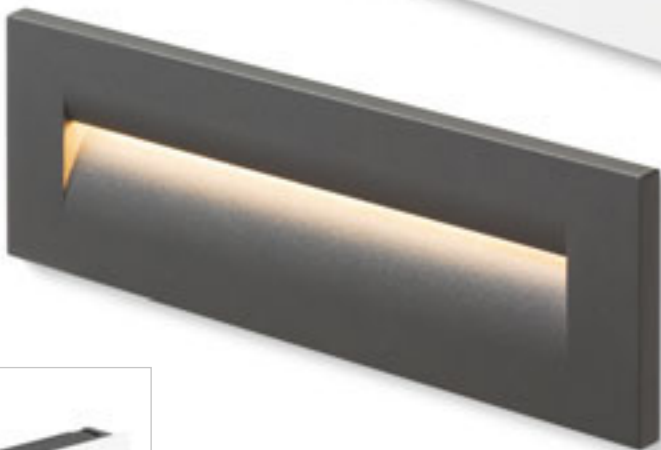

## RASQ

Lampada da incasso a parete con LED integrato, adatta sia per interni che per esterni. Adatta per l'illuminazione direzionale di sentieri, scale, o terrazze. Illuminazione solo in basso.

### RASQ DA INCASSO A PARETE

230 V LED 9 W 3000 K 190 lm Ra 80 IP65

R12627 bianco

€ 178

R12628 grigio antracite

€ 178

↑ 80

↙ 237x77



● LED

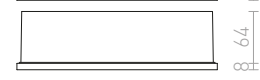
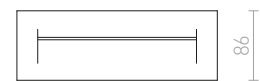

250

IP65



## INTRO

Applique da incasso in alluminio spazzolato con diodo COB LED incorporato. Spessore di piastra frontale è di 0,3 cm. Fornito con set di montaggio. Da connettere in serie.

### INTRO L

350 mA LED 3W 3000 K 185 lm Ra 80

**R10598** alluminio spazzolato

€ 58 %

↑ 60

■ 86x146



● LED

○ G13124

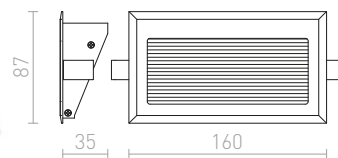







IP65



IP65



IP65



### GORDIQ

Apparecchio da incasso a parete con LED integrato per illuminazione direzionale di sentieri, scale o terrazze. Luce solo verso il basso.

#### GORDIQ L DA INCASSO

230 V LED 3 W 3000 K 90 lm Ra 80 IP65

R12537 bianco

€ 68

R12538 grigio antracite

€ 68

↑ 60

▣ 115x50

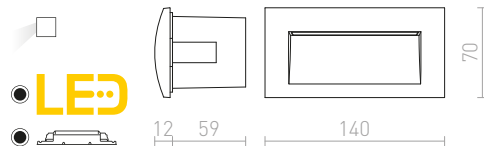

LED



#### GORDIQ M DA INCASSO

230 V LED 3 W 3000 K 90 lm Ra 80 IP65

R12535 bianco

€ 88

R12536 grigio antracite

€ 88

↑ 60

▣ 115x108

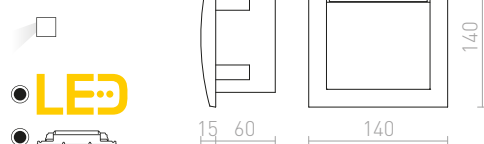

LED



#### GORDIQ S DA INCASSO

230 V LED 1,5 W 3000 K 30 lm Ra 80 IP65

R12533 bianco

€ 58

R12534 grigio antracite

€ 58

↑ 60

▣ 75x72

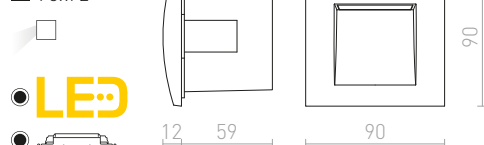

LED





IP65



IP65



## DEJAVU

Apparecchio da incasso a parete con LED integrato.  
Adatto come illuminazione orientabile per sentieri,  
scale o terrazze.

### DEJAVU SQ 9 DA INCASSO

230 V LED 3,5 W 3000 K 120 lm Ra 80 IP65

R12530 nero

€ 58 %

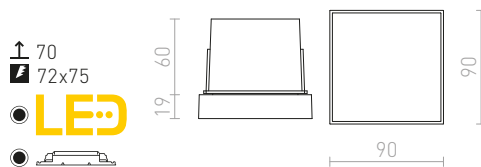

### DEJAVU SQ 14 DA INCASSO

230 V LED 6 W 3000 K 270 lm Ra 80 IP65

R12531 nero

€ 78 %

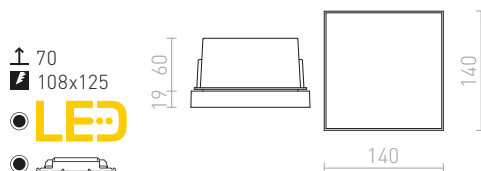







## SISTEMI 3F

|                  |         |
|------------------|---------|
| SISTEMI 3F       | 490-495 |
| FARETTI 3F       | 496-513 |
| A SOSPENSIONE 3F | 514-531 |

## SISTEMI 1F

|                  |         |
|------------------|---------|
| SISTEMI 1F       | 532-535 |
| FARETTI 1F       | 536-545 |
| A SOSPENSIONE 1F | 546-555 |

## STRISCE LED

|              |         |
|--------------|---------|
| STRISCIE LED | 556-561 |
| PROFILI      | 562-565 |



## SISTEMI 3F SISTEMI 3F

490-495



**EUTRAC 1m**  
490-495



**EUTRAC 2m**  
490-495



**EUTRAC 3m**  
490-495

## SISTEMI 3F FARETTI 3F

496-513



**FLATLINE 60**  
496-497



**FLATLINE 150**  
496-497



**FOCUS 12**  
498-499



**FOCUS 20**  
498-499



**FOCUS 30**  
498-499



**WISH 20**  
500-501



**WISH 30**  
500-501



**OPTIMUS**  
500-501



**ZUMA**  
500-501



**MAVRO**  
502-503



**LOLLIPOP**  
502-503



**TRAX**  
502-503



**MAVRO**  
502-503



**BAHIA**  
504-505



**PRODIGIS**  
504-505



**FANGIO**  
504-505



**DARIO**  
506-507



**CONNOR**  
506-507



**CADENZA**  
506-507



**FORZA**  
508-509



**BELENOS**  
508-509



**DUDE**  
508-509



**BEEBA I**  
510-511



**BEEBA II**  
510-511



**PURINA**  
510-511



**TRICA**  
510-511



**PIXIE**  
512-513



**PIXIE**  
512-513



**KELLY LED**  
512-513



**FAX E27**  
512-513



**FAX**  
512-513

## SISTEMI 3F A SOSPENSIONE 3F



**LUNA 20**  
514-515



**LUNA 25**  
514-515



**LUNA 30**  
514-515

514-531



**JULIETTA 16**  
516-517



**JULIETTA 31**  
516-517



**COPA**  
516-517



**BELLINI**  
516-517



**SANSSOUCI**  
518-519



**GARNISH**  
518-519



**EIGHT**  
518-519



**CHOUPETTE**  
520-521



**GIULIA 12**  
520-521



**GIULIA 20**  
520-521



**ARAQ**  
520-521



**AGNETA**  
522-523



**BLONDIE 25**  
522-523



**ASTON**  
522-523



**BUCKY 40**  
524-525



**MONROE 30**  
524-525

**SINTRA 30**  
524-525

**BABADES**  
526-527

**DESTY**  
526-527

**BELENOS**  
526-527



**MAVRO**  
526-527

**JACK RC**  
528-529

**BURTON**  
528-529

**TUTTI**  
528-529

**FRUTTI**  
528-529



**ELISA**  
530-531

SISTEMI 1F  
**SISTEMI 1F**

532-535



**1F 1m**  
532-535



**1F 2m**  
532-535

SISTEMI 1F  
**FARETTI 1F**

536-545



**FOCUS 12**  
536-537



**FOCUS 20**  
536-537



**OPTIMUS**  
536-537



**WISH 20**  
538-539

**WISH 30**  
538-539

**MAVRO**  
538-539

**BELENOS**  
540-541

**FORZA**  
540-541





**CADENZA**  
540-541



**DUDE**  
540-541



**CONNOR**  
542-543



**LALA**  
542-543



**SIENA**  
542-543



**DARIO**  
542-543



**TRICA**  
544-545



**PURINA**  
544-545



**BEEBA I**  
544-545



**BEEBA II**  
544-545

## SISTEMI 1F A SOSPENSIONE 1F

546-555



**LUNA 20**  
546-547



**LUNA 25**  
546-547



**LUNA 30**  
546-547



**COPA**  
546-547



**BELLINI L E14**  
548-549



**PULIRE RD**  
548-549



**PULIRE CON**  
548-549



**ARAQ**  
548-549



**GIULIA 12**  
550-551



**GIULIA 20**  
550-551



**JULIETTA 16**  
550-551



**JULIETTA 31**  
550-551



**ICAR**  
552-553



**CHOUETTE**  
552-553



**BABADES**  
552-553



**BELENOS**  
552-553



**MAVRO**  
552-553



**ELISA**  
554-555



**BLONDIE 25**  
554-555

**DESTY**  
554-555

**AGNETA**  
554-555

## STRISCE LED STRISCIE LED



556-561

**LED STRIP ORION RGB**  
556-557

**LED STRIP ORION RGBW**  
556-557

**LED STRIP ORION**  
558-559



**Wi-fi ovladač 5v1**  
556-557



**LEDSTRIPORION60,100,150**  
556-557



**LED STRIP IP54 5m**  
560-561



**LED STRIP IP20 5m**  
560-561



**LED STRIP**  
560-561



**LED STRIP**  
560-561

## STRISCE LED PROFILI



**LED PROFILE G**  
562-563



**LED PROFILE H**  
562-563



**LED PROFILE J**  
562-563

562-565



**LED PROFILE I 30/60**  
562-563



**LED PROFILE A**  
564-565



**LED PROFILE B**  
564-565



**LED PROFILE D**  
564-565

## EUTRAC

### BINARIO TRIFASE

Binario trifase EUTRAC. Qualsiasi profilo può essere facilmente tagliato nella lunghezza richiesta. Non è necessario tagliare o piegare le estremità dei conduttori. Nel caso di utilizzo di sorgenti alogene l'altezza minima di installazione è di 2,5m. Per utilizzi al di sotto di tale altezza si consiglia la sostituzione con sorgenti LED. NOTA: Per gli ordini di binari da 3 m possono esserci dei costi aggiuntivi per il trasporto!

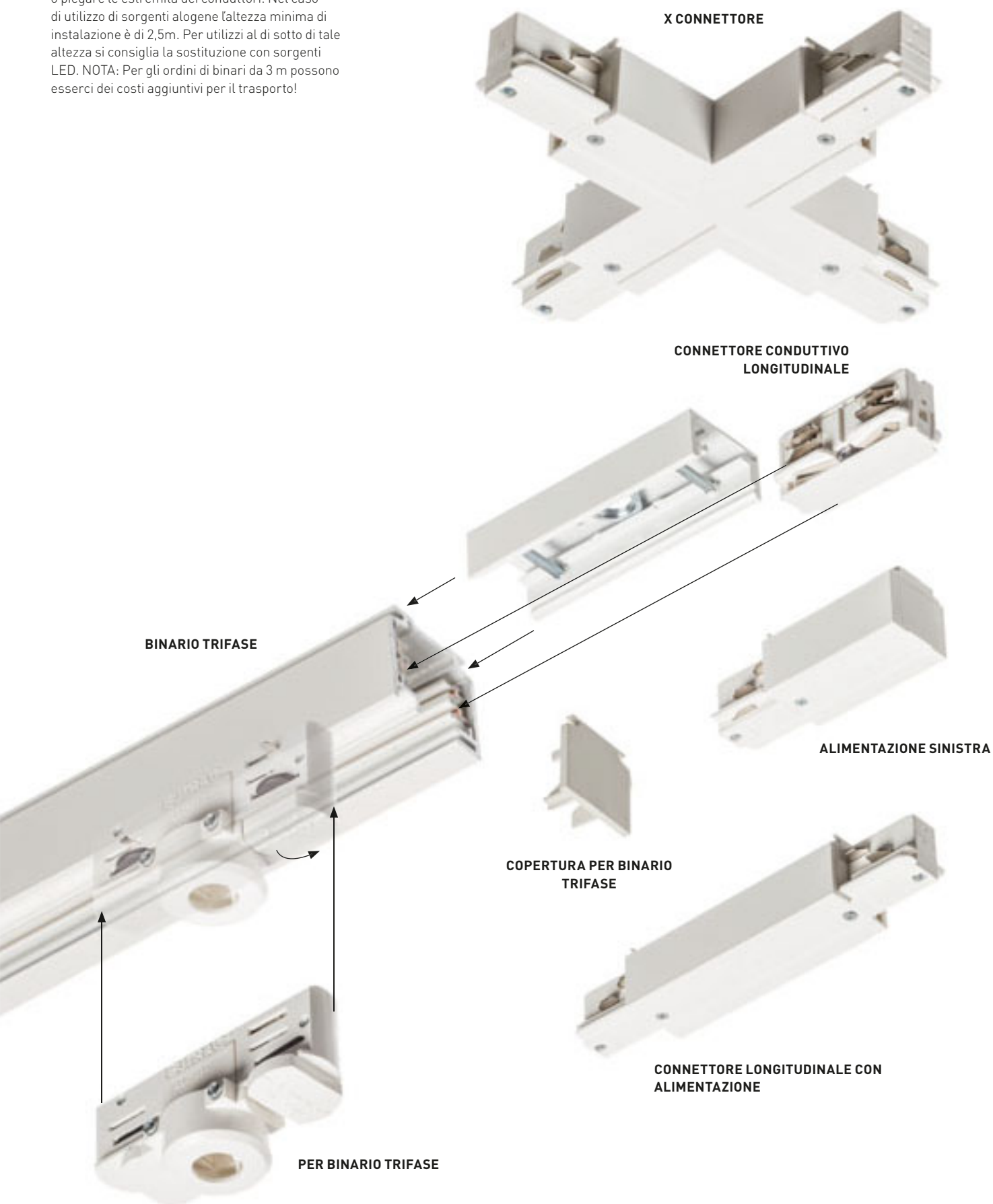

L CONNETTORE INTERNO



L CONNETTORE ESTERNO



CAVO DI SOSPENSIONE



CONNETTORE PER BINARIO TRIFASE



ADATTATORE A SOSPENSIONE PER BINARIO TRIFASE

ALIMENTAZIONE CONTINUA PER BINARIO TRIFASE



T CONNETTORE SINISTRO

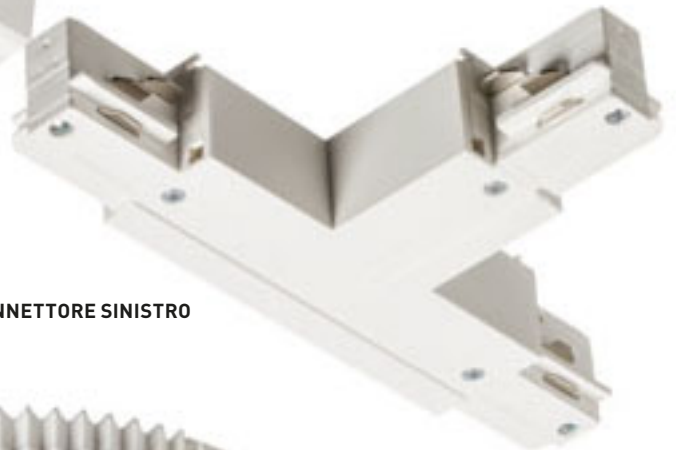

CONNETTORE FLEX



ADATTATORE MECCANICO



# EUTRAC

## BINARIO TRIFASE

Binario trifase EUTRAC. Qualsiasi profilo può essere facilmente tagliato nella lunghezza richiesta. Non è necessario tagliare o piegare le estremità dei conduttori. Nel caso di utilizzo di sorgenti alogene l'altezza minima di installazione è di 2,5m. Per utilizzi al di sotto di tale altezza si consiglia la sostituzione con sorgenti LED. NOTA: Per gli ordini di binari da 3 m possono esserci dei costi aggiuntivi per il trasporto!

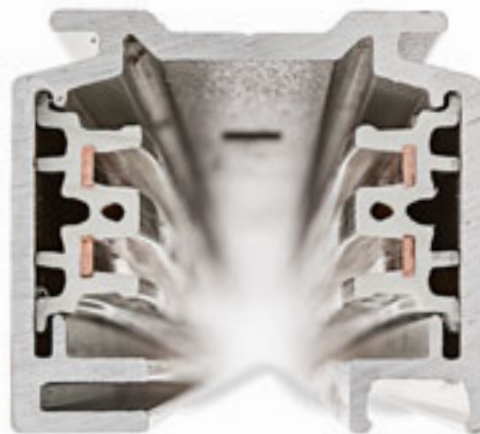

### 1M BINARIO TRIFASE

230 V

|                              |             |
|------------------------------|-------------|
| <b>R12072</b> bianco         | <b>€ 98</b> |
| <b>R12073</b> nero           | <b>€ 98</b> |
| <b>R12074</b> grigio argento | <b>€ 98</b> |

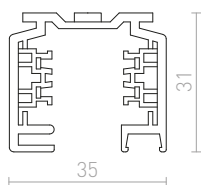

### L CONNETTORE INTERNO

Connessione a L con alimentazione per binario trifase EUTRAC. Carica massima 16A.

230 V

|                              |              |
|------------------------------|--------------|
| <b>R11326</b> bianco         | <b>€ 78</b>  |
| <b>R11327</b> nero           | <b>€ 78</b>  |
| <b>R11328</b> grigio argento | <b>€ 120</b> |

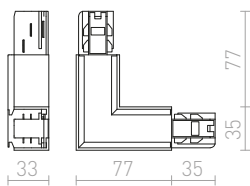

### L CONNETTORE ESTERNO

Connettore a L per binari trifase EUTRAC da incasso e carica massima di 16A.

230 V

|                              |              |
|------------------------------|--------------|
| <b>R11323</b> bianco         | <b>€ 78</b>  |
| <b>R11324</b> nero           | <b>€ 78</b>  |
| <b>R11325</b> grigio argento | <b>€ 120</b> |

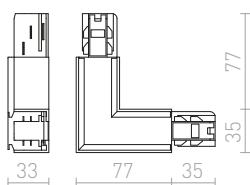

### 2M BINARIO TRIFASE

230 V

|                              |              |
|------------------------------|--------------|
| <b>R11300</b> bianco         | <b>€ 158</b> |
| <b>R11301</b> nero           | <b>€ 158</b> |
| <b>R11302</b> grigio argento | <b>€ 158</b> |

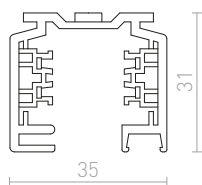

### T CONNETTORE DESTRO

Connettore a T con alimentazione per binario trifase EUTRAC. Carica massima 16A.

230 V

|                              |              |
|------------------------------|--------------|
| <b>R11332</b> bianco         | <b>€ 120</b> |
| <b>R11333</b> nero           | <b>€ 120</b> |
| <b>R11334</b> grigio argento | <b>€ 158</b> |

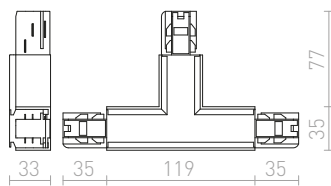

### T CONNETTORE SINISTRO

Connettore a T con alimentazione per binario trifase EUTRAC. Carica massima 16A.

230 V

|                              |              |
|------------------------------|--------------|
| <b>R11335</b> bianco         | <b>€ 120</b> |
| <b>R11336</b> nero           | <b>€ 120</b> |
| <b>R11337</b> grigio argento | <b>€ 158</b> |

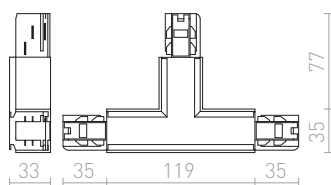

### 3M BINARIO TRIFASE

230 V

|                              |              |
|------------------------------|--------------|
| <b>R11303</b> bianco         | <b>€ 238</b> |
| <b>R11304</b> nero           | <b>€ 238</b> |
| <b>R11305</b> grigio argento | <b>€ 238</b> |

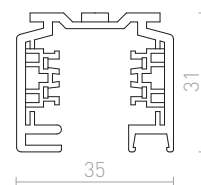

### ALIMENTAZIONE DESTRA

Alimentazione per binari trifase EUTRAC da parete/da soffitto/a sospensione. Carica massima 16A.

230 V

|                              |             |
|------------------------------|-------------|
| <b>R11311</b> bianco         | <b>€ 35</b> |
| <b>R11312</b> nero           | <b>€ 35</b> |
| <b>R11313</b> grigio argento | <b>€ 48</b> |

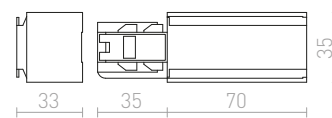

### ALIMENTAZIONE SINISTRA

Alimentazione per binari trifase EUTRAC da parete/da soffitto/a sospensione. Carica massima 16A.

230 V

|                              |             |
|------------------------------|-------------|
| <b>R11314</b> bianco         | <b>€ 35</b> |
| <b>R11315</b> nero           | <b>€ 35</b> |
| <b>R11316</b> grigio argento | <b>€ 48</b> |

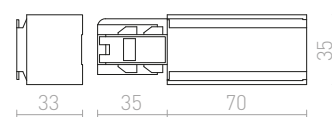



**CONNETTORE CONDUTTIVO LONGITUDINALE**

Connettore conduttivo longitudinale per binari trifase EUTRAC. Per ragioni statiche, un supporto meccanico (R11354, R11355 o R11356) viene richiesto per installazioni a sospensione. Carica massima 16A. 230 V

- R11317** bianco € 24
- R11318** nero € 24
- R11319** grigio argento € 29

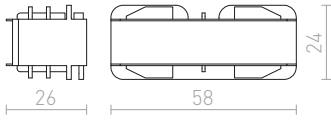

**CONNETTORE FLEX**

Connettore flex per binari trifase EUTRAC. Raggio da 30° a 330°. Può essere usato come alimentazione. Carica massima 16A.

- 230 V
- R11329** bianco € 120
- R11330** nero € 120
- R11331** grigio argento € 120

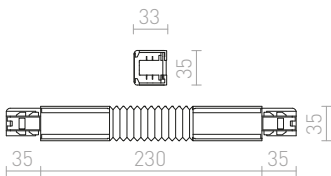

**CONNETTORE LONGITUDINALE CON ALIMENTAZIONE**

Connettore conduttivo longitudinale con alimentazione per binari trifase EUTRAC. Carica massima 16A.

- 230 V
- R11320** bianco € 78
- R11321** nero € 78
- R11322** grigio argento € 120



**X CONNETTORE**

Connettore a X con alimentazione per binari trifase EUTRAC, con possibilità di connettere due circuiti separati. Carica massima 16A.

- 230 V
- R11338** bianco € 150
- R11339** nero € 150
- R11340** grigio argento € 198

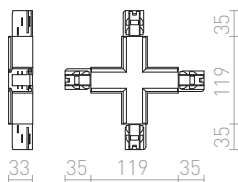

**ALIMENTAZIONE CONTINUA PER BINARIO TRIFASE**

Alimentazione continua per binario trifase EUTRAC. Può essere installato senza dovere tagliare il binario. Carica massima 16A.

- 230 V
- R11346** bianco € 58
- R11347** nero € 58
- R11348** grigio argento € 78

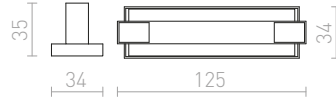

**PER BINARIO TRIFASE**

Carico massimo di 5 kg e 10A.

- 230 V
- R11360** bianco € 32
- R11361** nero € 32
- R11362** grigio argento € 48

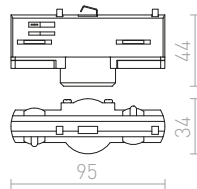

**COPERTURA PER BINARIO TRIFASE**

Copertura terminale per binario trifase EUTRAC.

- R11307** bianco € 3.20
- R11308** nero € 3.20
- R11309** grigio argento € 6

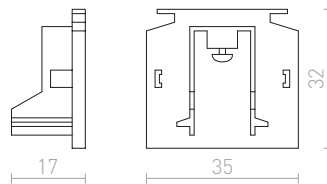

**ADATTATORE MECCANICO**

Adattatore meccanico per binari trifase EUTRAC da parete / da soffitto o da incasso. Carico massimo 10 kg.

- R11352** bianco € 25
- R11353** nero € 25

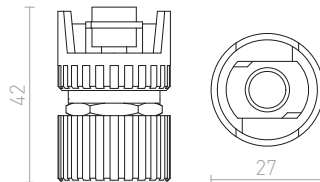

**3M CAVO DI SOSPENSIONE**

Cavo di sospensione per binario trifase EUTRAC con filettatura M13.

- R11359** € 48

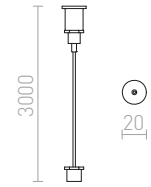

**1,5M CAVO DI SOSPENSIONE**

Cavo di sospensione per binario trifase EUTRAC con filettatura M13.

- R11358** € 48

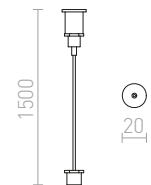

**ADATTATORE A SOSPENSIONE PER BINARIO TRIFASE**

Adattatore per cavo di sospensione. Filettatura M13.

- R11349** bianco € 14
- R11350** nero € 14
- R11351** grigio argento € 16

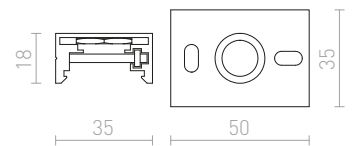

**CONNETTORE PER BINARIO TRIFASE**

Connettore meccanico utilizzato per rafforzare congiunzione di due binari sospesi con conettore conduttivo longitudinale.

- R11354** bianco € 24
- R11355** nero € 24
- R11356** grigio argento € 26

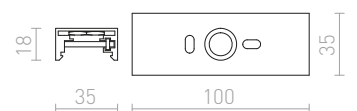

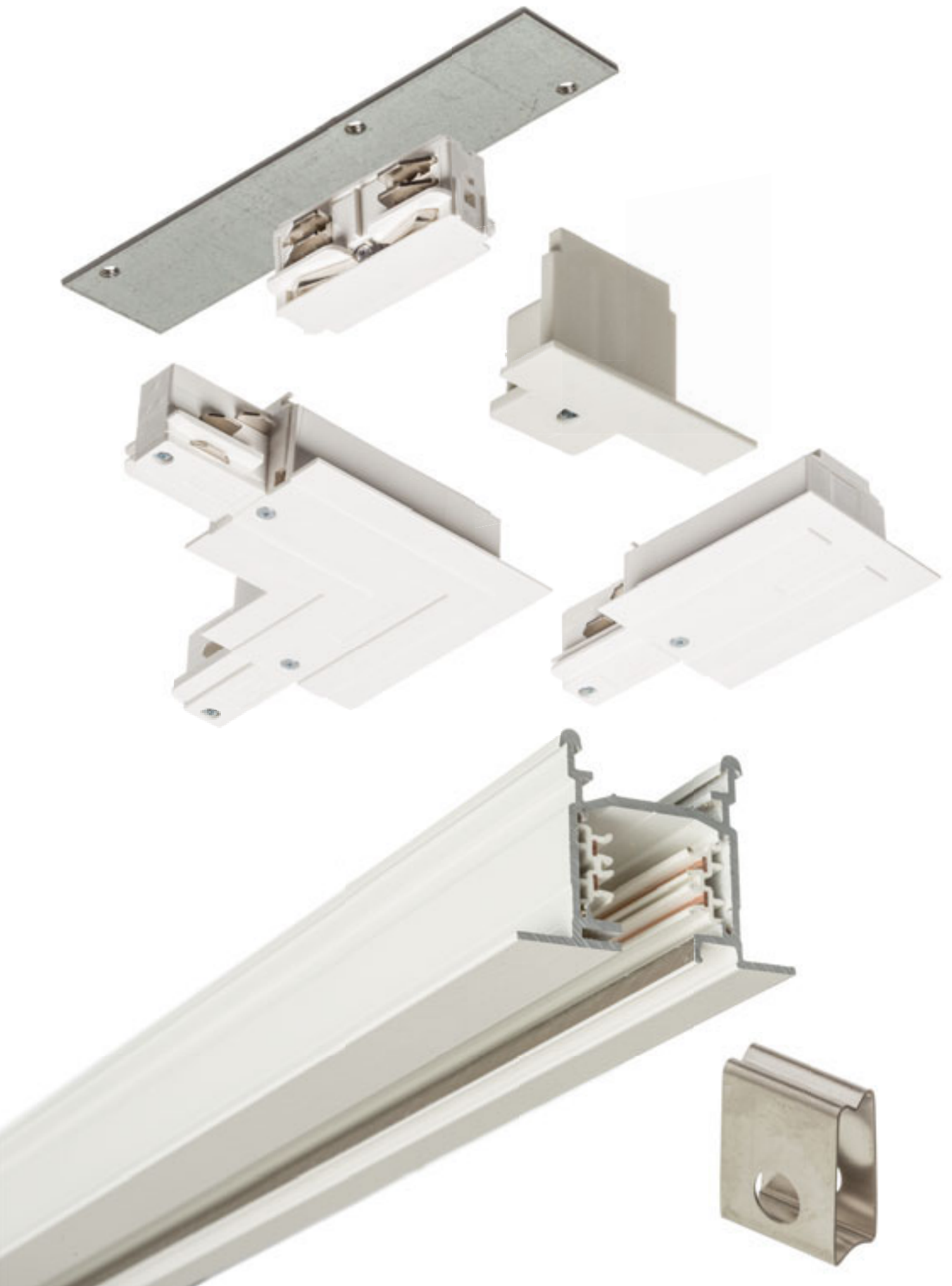

### BINARIO TRIFASE DA INCASSO

Binario trifase EUTRAC da incasso, in alluminio estruso che serve come messa a terra, quattro conduttori di rame con diametro di 2,5 mm posati all'interno di due profili in plastica. Qualsiasi profilo può essere facilmente tagliato nella lunghezza richiesta. Non è necessario tagliare o piegare le estremità dei conduttori. Nel caso di utilizzo di sorgenti alogene l'altezza minima di installazione è di 2,5m. Per utilizzi al di sotto di tale altezza si consiglia la sostituzione con sorgenti LED.

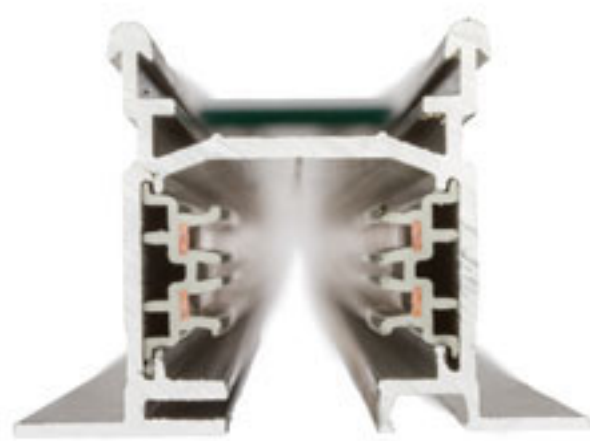

### ALIMENTAZIONE PER BINARIO DA INCASSO SINISTRA

Alimentazione per binari trifase EUTRAC da incasso, carica massima fino a 16A.

230 V  
**R11342** bianco € 48

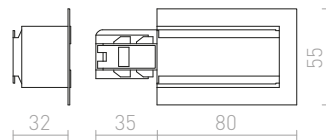

### ALIMENTAZIONE PER BINARIO DA INCASSO DESTRA

Alimentazione per binari trifase EUTRAC da incasso. Carica massima 16A.

230 V  
**R11341** bianco € 48

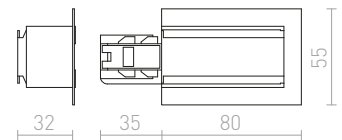

### L CONNETTORE PER BINARIO DA INCASSO ESTERNA

Connettore a L per binari trifase EUTRAC da incasso e carica massima di 16A.

230 V  
**R11344** bianco € 88

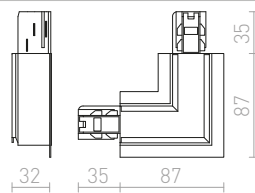

### L CONNETTORE PER BINARIO DA INCASSO INTERNA

Connettore a L con possibilità di alimentazione per binario trifase EUTRAC da incasso e carica massima di 16A.

230 V  
**R11345** bianco € 88

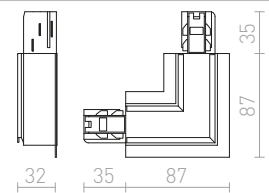

### 2M BINARIO TRIFASE DA INCASSO

230 V  
**R11306** bianco € 238

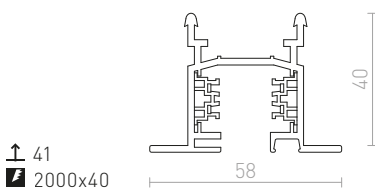

### CONNETTORE CONDUTTIVO DIRETTO PER BINARIO DA INCASSO

Connettore conduttivo longitudinale per binari EUTRAC. Carica massima 16A.

230 V  
**R11343** bianco € 32

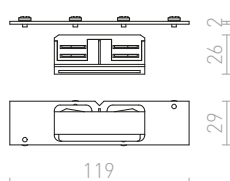

### COPERTURA TERMINALE PER BINARIO DA INCASSO

Copertura per binari trifase EUTRAC da incasso.

**R11310** bianco € 8



### FERMAGLI A MOLLA PER BINARIO DA INCASSO TRIFASE 6 PEZZI

Kit di agganci binari trifase EUTRAC da incasso.

**R11357** € 16

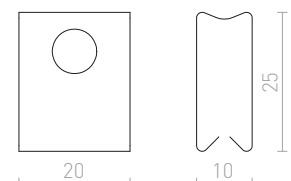





## FLATLINE

Apparecchio lineare con illuminazione spaziale per binario trifase. Sull'adattatore dell'apparecchio è possibile impostare diverse potenze luminose: 35W, 40W, 45W o 50W.

### FLATLINE 150 PER BINARIO TRIFASE

230 V LED 50 W  $\angle 90^\circ$  3000 K 8000 lm Ra 80

R13732 bianco

€ 258

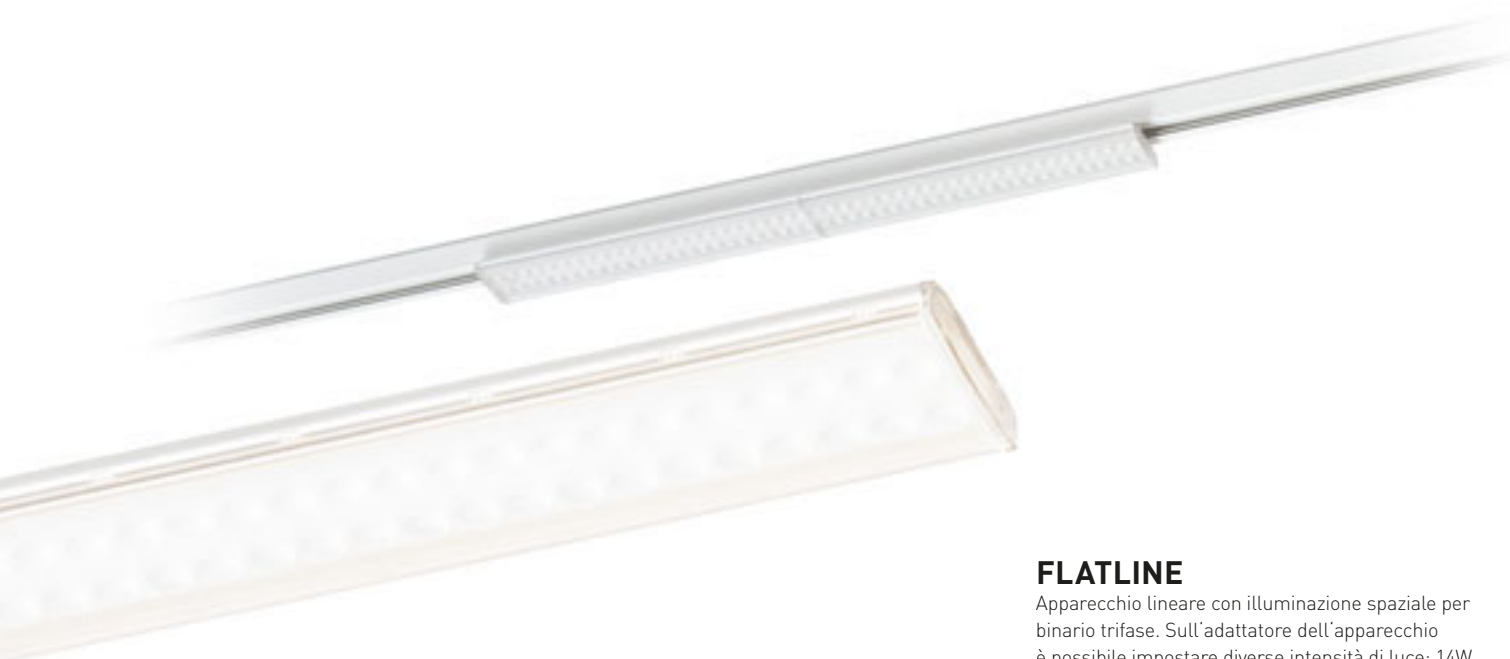
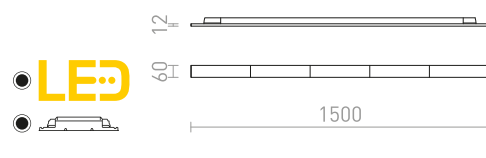

## FLATLINE

Apparecchio lineare con illuminazione spaziale per binario trifase. Sull'adattatore dell'apparecchio è possibile impostare diverse intensità di luce: 14W, 16W, 18W o 20W.

### FLATLINE 60 PER BINARIO TRIFASE

230 V LED 20 W  $\angle 90^\circ$  3000 K 3200 lm Ra 80

R13731 bianco

€ 188

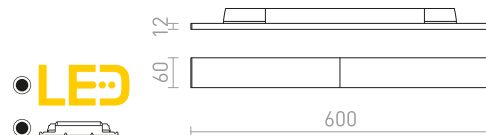







## FOCUS

Lampada tubolare dimmerabile per binario trifase con possibilità di regolare il cono di luce tramite il sistema zoom 10 - 60°. Tramite l'interruttore sulla lampada è possibile impostare il colore della luce: 3000K, 4000K, 5000K. Dimmerazione del TRIAC.

### FOCUS 12 DIMM PER BINARIO TRIFASE

230 V LED 12 W  $\angle 10-60^\circ$  3000 K 4000 K 5000 K  
780 lm Ra 80

**R13882** bianco

€ 98 **NEW**

**R13883** nero

€ 98 **NEW**

● **LED**  
● dimmerabile

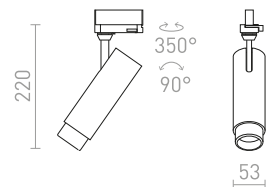

### FOCUS 20 DIMM PER BINARIO TRIFASE

230 V LED 20 W  $\angle 10-60^\circ$  3000 K 4000 K 5000 K  
1540 lm Ra 80

**R13884** bianco

€ 120 **NEW**

**R13885** nero

€ 120 **NEW**

● **LED**  
● dimmerabile

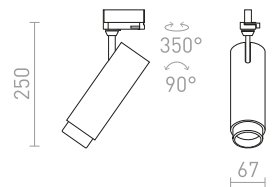

### FOCUS 30 DIMM PER BINARIO TRIFASE

230 V LED 30 W  $\angle 10-60^\circ$  3000 K 4000 K 5000 K  
2300 lm Ra 80

**R13886** bianco

€ 150 **NEW**

**R13887** nero

€ 150 **NEW**

● **LED**  
● dimmerabile

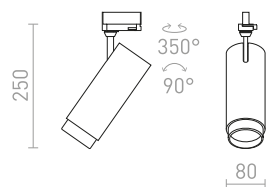



## ZUMA

Faretto a tubo per binario trifase con possibilità di regolare cono luminoso mediante un sistema di zoom da 10-50°. Dimmerazione TRIAC.

### ZUMA DIMM PER BINARIO TRIFASE

230 V LED 20 W  $\angle 10-50^\circ$  3000 K 1000 lm Ra 80

R13529 bianco

€ 129

R13531 nero

€ 129

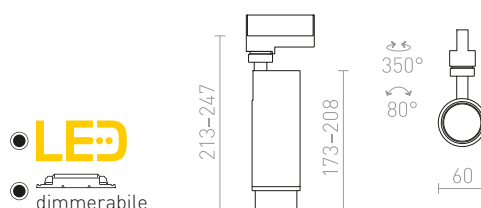

## OPTIMUS

Apparecchio cilindrico adatto per il binario trifase con la possibilità di regolare il cono di luce tramite il sistema di zoom 10-50°. L'apparecchio è adatto per sorgenti luminose LED con portalampada GU10. Da usare con sorgenti luminose con fascio di luce di 120° per evitare ombre indesiderate.

### OPTIMUS PER BINARIO TRIFASE

230 V LED GU10 9 W  $\angle 10-50^\circ$

R13783 bianco

€ 68

R13784 nero

€ 68

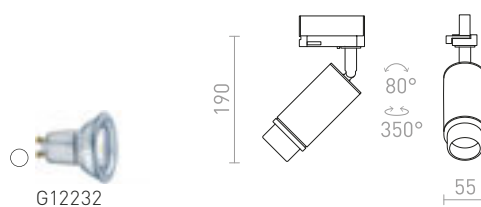



## WISH

Apparecchio cilindrico dimmerabile per binario trifase con possibilità di impostare il colore di luce: bianco caldo (WW), bianco neutro (NW), bianco freddo (CW). Dimmerazione TRIAC.

### WISH 20 DIMM PER BINARIO TRIFASE

230 V LED 20 W  $\angle 36^\circ$  3000 K 4000 K 5000 K  
1600 lm Ra 80

**R13773** bianco

€ 120 **NEW**

**R13774** nero

€ 120 **NEW**

● **LED**  
● dimmerabile

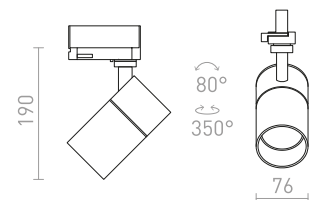

### WISH 30 DIMM PER BINARIO TRIFASE

230 V LED 30 W  $\angle 36^\circ$  3000 K 4000 K 5000 K  
2400 lm Ra 80

**R13775** bianco

€ 129 **NEW**

**R13776** nero

€ 129 **NEW**

● **LED**  
● dimmerabile

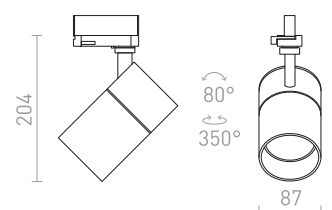



## LOLLIPOP

Proiettore cilindrico per binario trifase con sorgente luminosa a LED integrato.

### LOLLIPOP PER BINARIO TRIFASE

230 V LED 8 W  $\angle 40^\circ$  3000 K 620 lm Ra 80

R12412 bianco

€ 48 %

R12413 nero

€ 48 %

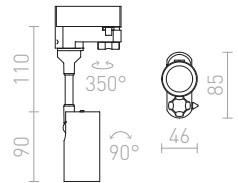

## TRAX

Riflettore LED dal design semplice per binario trifase con diverso trattamento di colori interno/esterno.

### TRAX PER BINARIO TRIFASE

230 V/400 mA LED 15 W  $\angle 38^\circ$  3000 K 1370 lm Ra 80

R11694 bianco/oro

€ 120 %

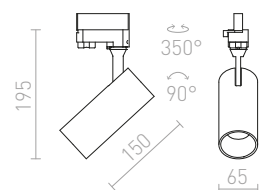

## MAVRO

Faretto LED a tubo, adatto per binario trifase. Dimmerazione TRIAC.

### MAVRO DIMM PER BINARIO TRIFASE

230 V LED 12 W  $\angle 38^\circ$  3000 K 1020 lm Ra 80

R13171 bianco

€ 178

R13172 oro

€ 178 ➔

R13173 nero/oro

€ 178

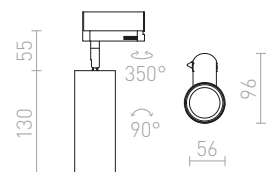





## MAVRO

Faretto cilindrico con LED integrato per binario trifase.

### MAVRO PER BINARIO TRIFASE

230 V LED 12 W  $\angle 38^\circ$  3000 K 1020 lm Ra 80

R12995 bianco

€ 120

R12996 oro

€ 120

R12997 nero/oro

€ 120

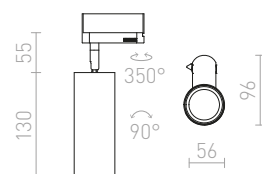



## FANGIO

Riflettore per binario trifase in due versioni di colore.

### FANGIO PER BINARIO TRIFASE

230 V LED 25 W  $\angle 36^\circ$  3000 K 2200 lm Ra 80

**R12059** grigio argento

€ 88 %

**R12060** nero

€ 88 %

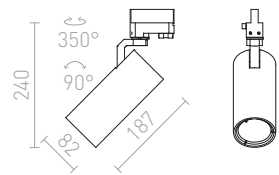



## BAHIA

Potente riflettore a LED adatto per binari trifase.

### BAHIA PER BINARIO TRIFASE

230 V LED 28 W  $\angle 38^\circ$  3000 K 2700 lm Ra 80

R12823 bianco

€ 150

R12824 nero

€ 150

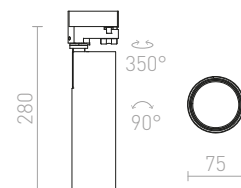

## PRODIGI

Riflettore cilindrico per binari trifase con diodo LED 10W incluso.

### PRODIGI S PER BINARIO TRIFASE

230 V LED 10 W  $\angle 36^\circ$  3000 K 1000 lm Ra 80

R13000 bianco

€ 78

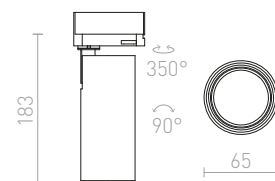



## DARIO

Faretto cilindrico per binario trifase e lampadina LED con attacco GU10 comprensivo di anello decorativo in metallo in colore ottone spazzolato. Per cambiare colore è possibile acquistare un anello bianco o nero.

### DARIO PER BINARIO TRIFASE

230 V GU10 9 W

**R13873** bianco/ottone spazzolato

€ 98

NEW

**R13874** nero/ottone spazzolato

€ 98

NEW

**R13875** ottone spazzolato

€ 120

NEW

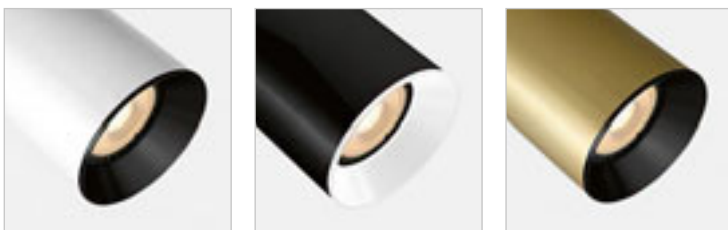
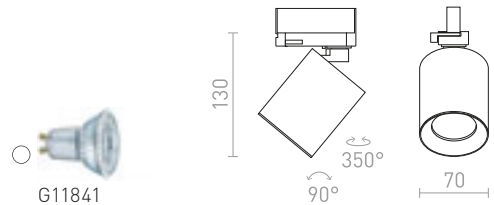
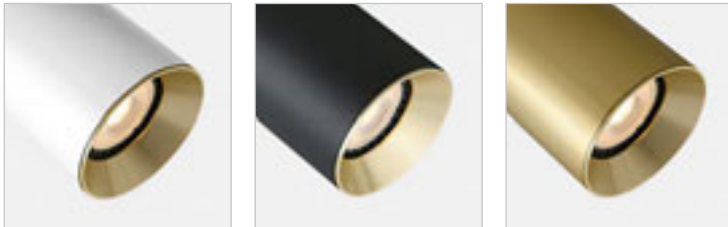

## DARIO

Anello decorativo in alluminio per la possibilità di cambiare il colore delle lampade DARIO.

### DARIO ANELLO DECORATIVO

**R13876** bianco

€ 8.50

NEW

**R13877** nero

€ 8.50

NEW

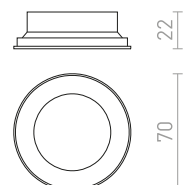





## CADENZA

Faretto cilindrico con portalampada GU10 per binari trifase.

### CADENZA PER BINARIO TRIFASE

230 V LED GU10 10 W

R13348 bianco

€ 68

R13349 nero

€ 68

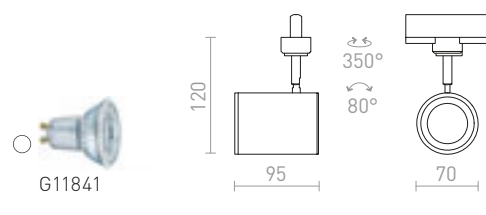

## CONNOR

Faretto cilindrico con portalampada GU10 per binario trifase.

### CONNOR PER BINARIO TRIFASE

230 V LED GU10 10 W

R13499 bianco/nero

€ 68

R13500 nero/oro

€ 68

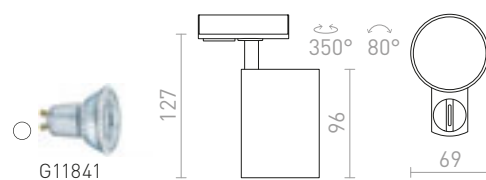





## DUDE

Riflettore cilindrico per binario trifase per sorgente luminosa a LED con attacco GU10.

### DUDE PER BINARIO TRIFASE

230 V LED GU10 9 W

**R13928** bianco

€ 58 **NEW**

**R13929** nero

€ 58 **NEW**

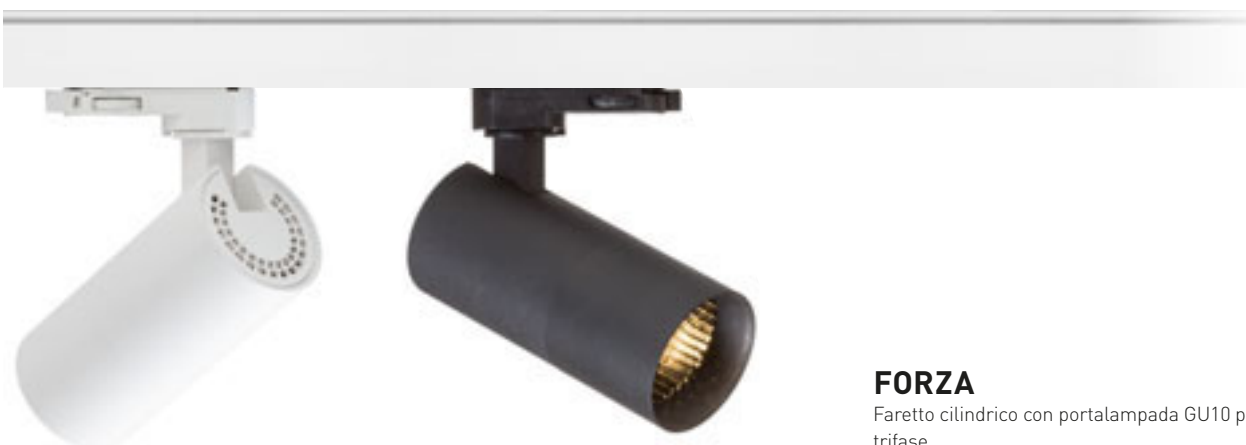
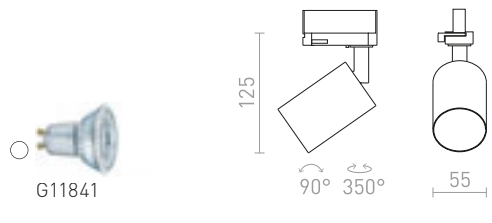

## FORZA

Faretto cilindrico con portalampada GU10 per binari trifase.

### FORZA PER BINARIO TRIFASE

230 V LED GU10 10 W

**R13352** bianco

€ 78

**R13353** nero

€ 78

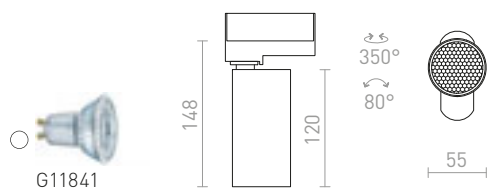

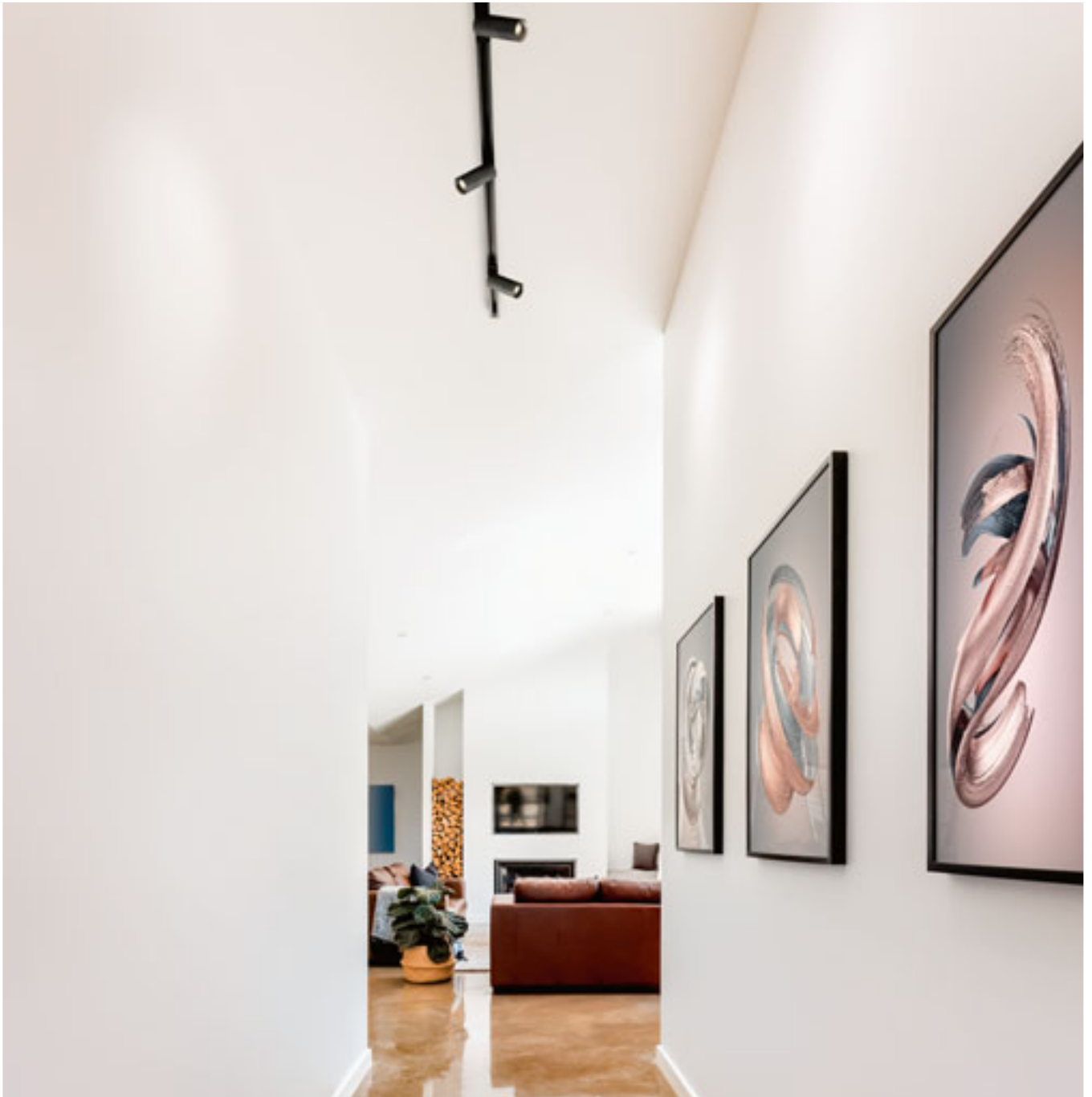

## BELENOS

Faretto cilindrico semplice, per sorgenti luminose con portalampada GU10 per binario trifase. Le molle fissate alla base consentono l'uso di sorgenti luminose di varie lunghezze.

### BELENOS PER BINARIO TRIFASE

230 V LED GU10 9 W

**R13368** bianco

€ 68

**R13370** nero

€ 68

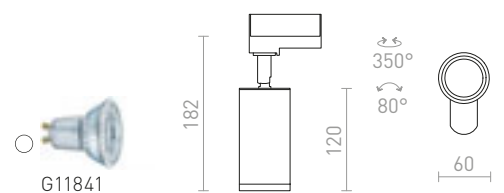

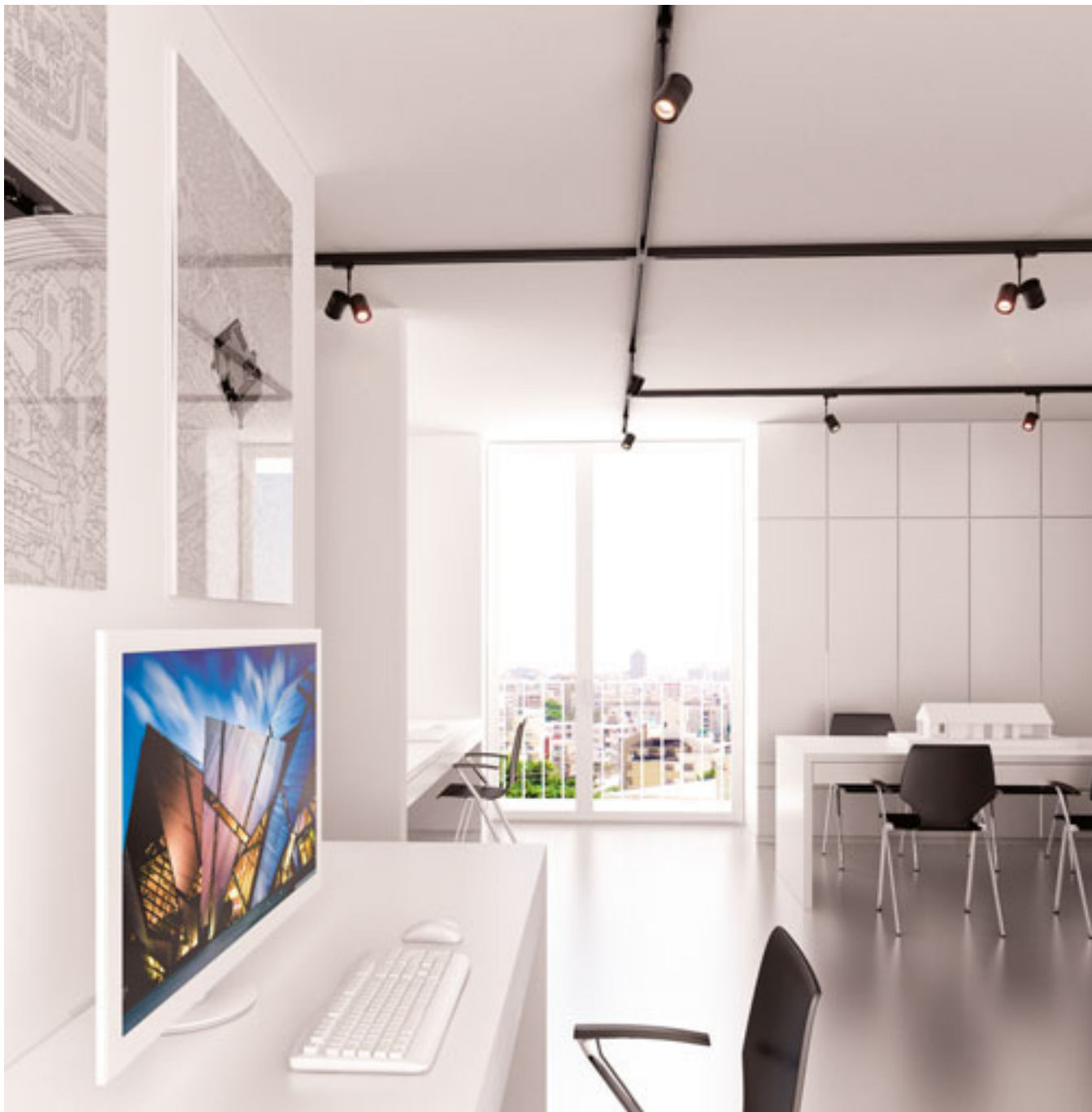

## TRICA

Apparecchio per binario trifase con portalampada GU10. Adatto per sorgenti luminose con diametro di 111 mm oppure 51 mm. Le dimensioni del prodotto sono indicate senza sorgente luminosa.

### TRICA PER BINARIO TRIFASE

230 V GU10 50 W

R12006 nero

€ 32

R12007 bianco

€ 32

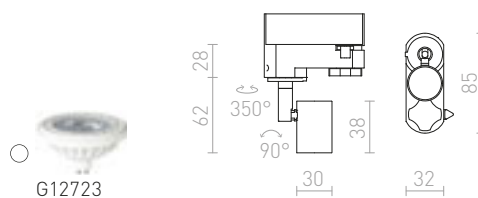

G12723



## PURINA

Riflettore con portalampada GU10 per binario trifase disponibile in tre colori. Fornito con anello decorativo per sorgenti luminose con riflettori da 51 mm. Possono essere utilizzate anche sorgenti luminose ES111.

### PURINA PER BINARIO TRIFASE

230 V GU10 50 W

**R12317** bianco € 26 %

**R12318** grigio argento € 26 %

**R12319** nero € 48 %



G11841

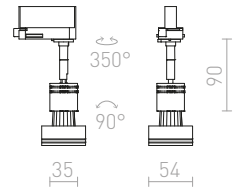

## BEEBA

Riflettore per binari trifase in tre varianti di colore.

### BEEBA I PER BINARIO TRIFASE

230 V GU10 35 W

**R12305** bianco € 68 %

**R12306** grigio argento € 48 %

**R12307** nero € 68 %



G11837

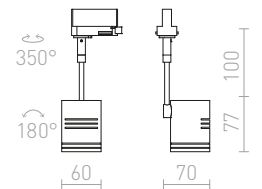

### BEEBA II PER BINARIO TRIFASE

230 V GU10 2x35 W

**R12311** bianco € 98 %

**R12312** grigio argento € 58 %

**R12313** nero € 98 %



G11837

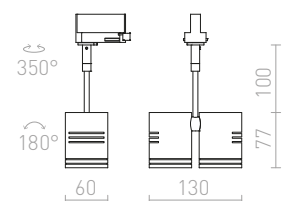



## PIXIE

Apparecchio inclinabile con adattatore per binari trifase nelle tre varianti di colore. Progettato per sorgenti luminose a risparmio energetico con portalampada GX53.

### PIXIE A COLLO DI CIGNO PER BINARIO TRIFASE

230 V LED GX53 7 W

**R10641** grigio argento/cromo

€ 158

**R11768** bianco

€ 178

**R11769** nero

€ 178

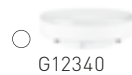

G12340

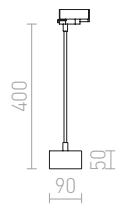

### PIXIE PER BINARIO TRIFASE

230 V LED GX53 7 W

**R10640** grigio argento/cromo

€ 178

**R10644** bianco/cromo

€ 178

**R10645** nero/cromo

€ 178

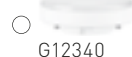

G12340

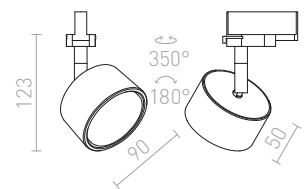





## FAX

Apparecchio per binario, semplice ed adatto per sorgenti riflettenti con portalampada E27.

### FAX E27 PER BINARIO TRIFASE

230 V E27 25 W

R13535 bianco

€ 32

R13537 nero

€ 32

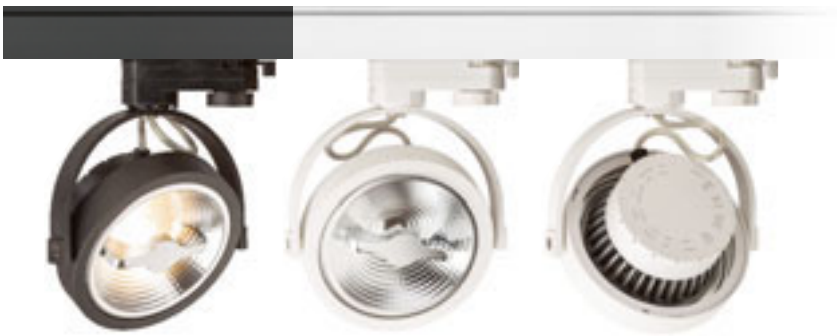
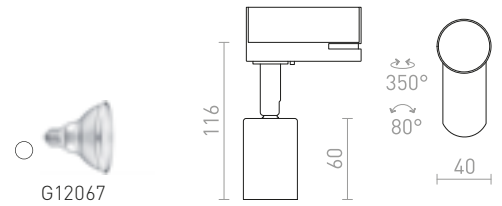

## KELLY LED

Riflettore per binario trifase con sorgente luminosa a LED integrato.

### KELLY LED PER BINARIO TRIFASE

230 V LED 12 W  $\angle 24^\circ$  3000 K 600 lm Ra 80

R12338 bianco

€ 120

R12339 nero

€ 120

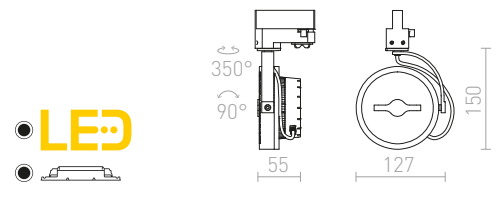

## FAX

Apparecchio con portalampada GU10 per binario trifase. È possibile usare sorgenti luminose con diametro di 111 o 51 mm. Le dimensioni del corpo dell'apparecchio sono 5x6,5 cm (ØxAI). Le dimensioni indicate senza sorgente luminosa.

### FAX PER BINARIO TRIFASE

230 V GU10 50 W

R11724 nero

€ 48

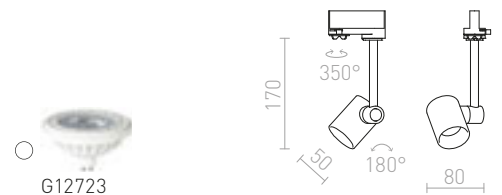





## LUNA

Lampada a sospensione in vetro opalino con finiture cromate e cavo trasparente. Il cavo di alimentazione è completo di un adattatore finale per binario trifase.

### LUNA 20 PER BINARIO TRIFASE

230 V LED E27 15 W

**R13967** vetro opalino/cromo

€ 129 **NEW**

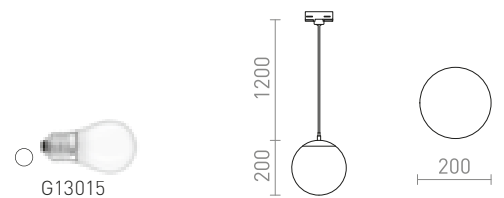

### LUNA 25 PER BINARIO TRIFASE

230 V LED E27 15 W

**R13968** vetro opalino/cromo

€ 178 **NEW**

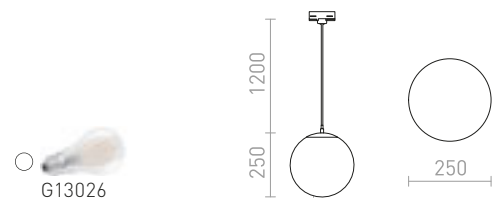

### LUNA 30 PER BINARIO TRIFASE

230 V E27 15 W

**R13969** vetro opalino/cromo

€ 229 **NEW**

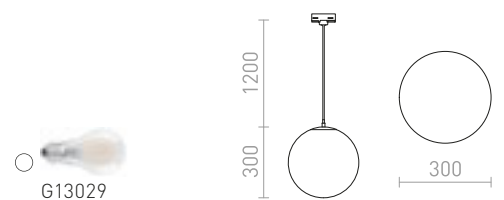



## BELLINI

Lampada a sospensione in vetro con accessori laccati, adatta per sorgente luminosa LED con portalampana E14. Il cavo di alimentazione è completo di un adattatore finale per binario trifase.

### BELLINI PER BINARIO TRIFASE

230 V E14 15 W

R13814 bianco/vetro trasparente

€ 215

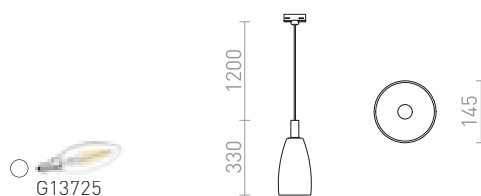

## JULIETTA

Lampada di design a sospensione con vetro cilindrico opalino. Elementi in metallo verniciato, cavo di tessuto nero. Il cavo di alimentazione è completo di un adattatore finale per binario trifase.

### JULIETTA 16 PER BINARIO TRIFASE

230 V E27 20 W

R13855 vetro opalino/nero

€ 150

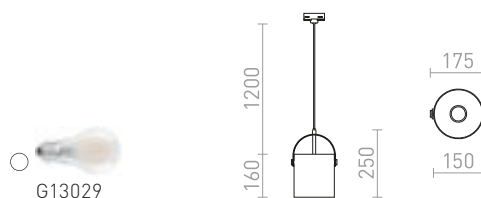

### JULIETTA 31 PER BINARIO TRIFASE

230 V E27 20 W

R13856 vetro opalino/nero

€ 178

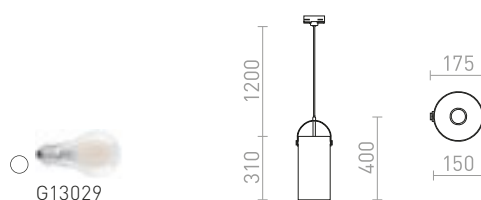



## COPA

Apparecchio a sospensione con paralume in vetro.  
Disponibile in due colori. Con adattatore per binario trifase.

### COPA PER BINARIO TRIFASE

230 V E27 28 W

**R13207** vetro opalino

€ 188

**R13208** nero/vetro

€ 198

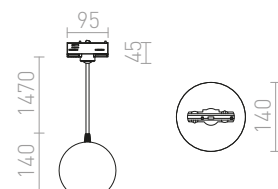





## GARNISH

Lampada a sospensione con paralume in vetro trasparente e accessori cromati. Il paralume di vetro è chiuso in basso ed è possibile inserire delle decorazioni adatte. Il cavo di alimentazione è completo di un adattatore finale per binario trifase.

### GARNISH PER BINARIO TRIFASE

230 V GU10 9 W

R13815 vetro trasparente/cromo

€ 178

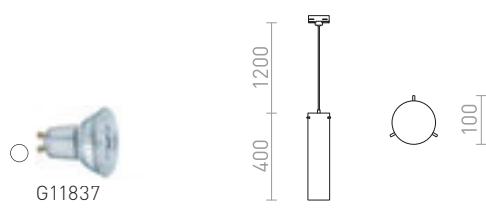

## EIGHT

Lampada a sospensione con vetro cilindrico opalino con accessori cromati. Il cavo di alimentazione è completato di un adattatore finale per binario trifase.

### EIGHT PER BINARIO TRIFASE A SOSPENSIONE

230 V E27 28 W

R13854 vetro opalino/cromo

€ 178

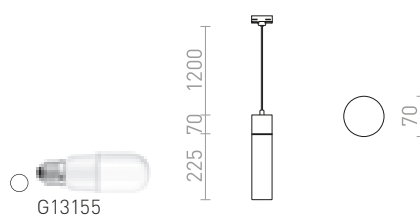



## SANSSOUCI

Apparecchio a sospensione con paralume in vetro e con un adattatore finale per binario trifase. A luce spenta si ha un effetto speculare, a luce accesa sorgenti luminose sono parzialmente visibili.

### SANSSOUCI PER BINARIO TRIFASE

230 V E27 42 W

**R12095** vetro cromato

€ 129

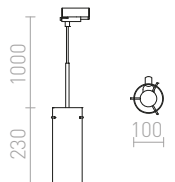

### SANSSOUCI PER BINARIO TRIFASE

230 V E27 42 W

**R12094** vetro in rame

€ 129

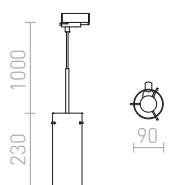



## GIULIA

Lampada a sospensione in metallo verniciato con cavo di tessuto. Il cavo di alimentazione è completo di un adattatore finale per binario trifase.

### GIULIA 12 PER BINARIO TRIFASE

230 V E27 40 W

R13990 bianco/cromo

€ 88

NEW

R13991 nero/marrone dorato/ottone

€ 98

NEW

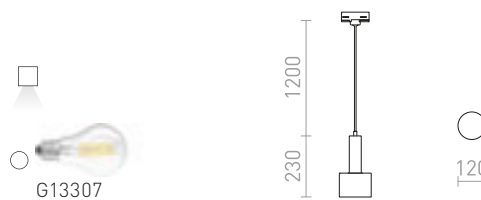

### GIULIA 20 PER BINARIO TRIFASE

230 V E27 40 W

R13992 bianco/cromo

€ 98

NEW

R13993 nero/marrone dorato/ottone

€ 120

NEW

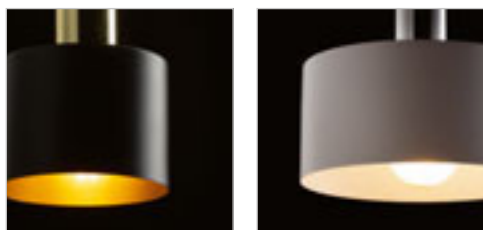
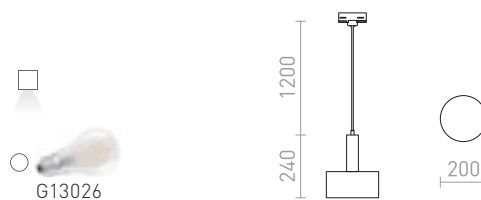



## ARAQ

Apparecchio a sospensione con portalampada in ottone, cavo tessile rifinito con un adattatore per binario trifase. Adatto per lampadina decorativa con attacco E27.

### ARAQ PER BINARIO TRIFASE A SOSPENSIONE

230 V E27 42 W

**R13979** ottone spazzolato/nero

€ 68 **NEW**



## CHOUPELLE

Apparecchio a sospensione tessile con decorazione in legno, compatibile con sorgente LED E27. Per installazione su binario trifase.

### CHOUPELLE PER BINARIO TRIFASE

230 V E27 15 W

**R13721** grigio nerastro/tessuto/legno

€ 150

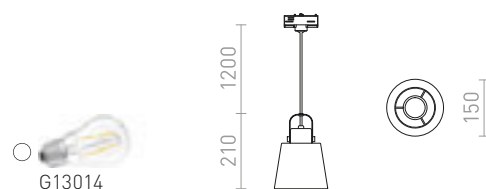

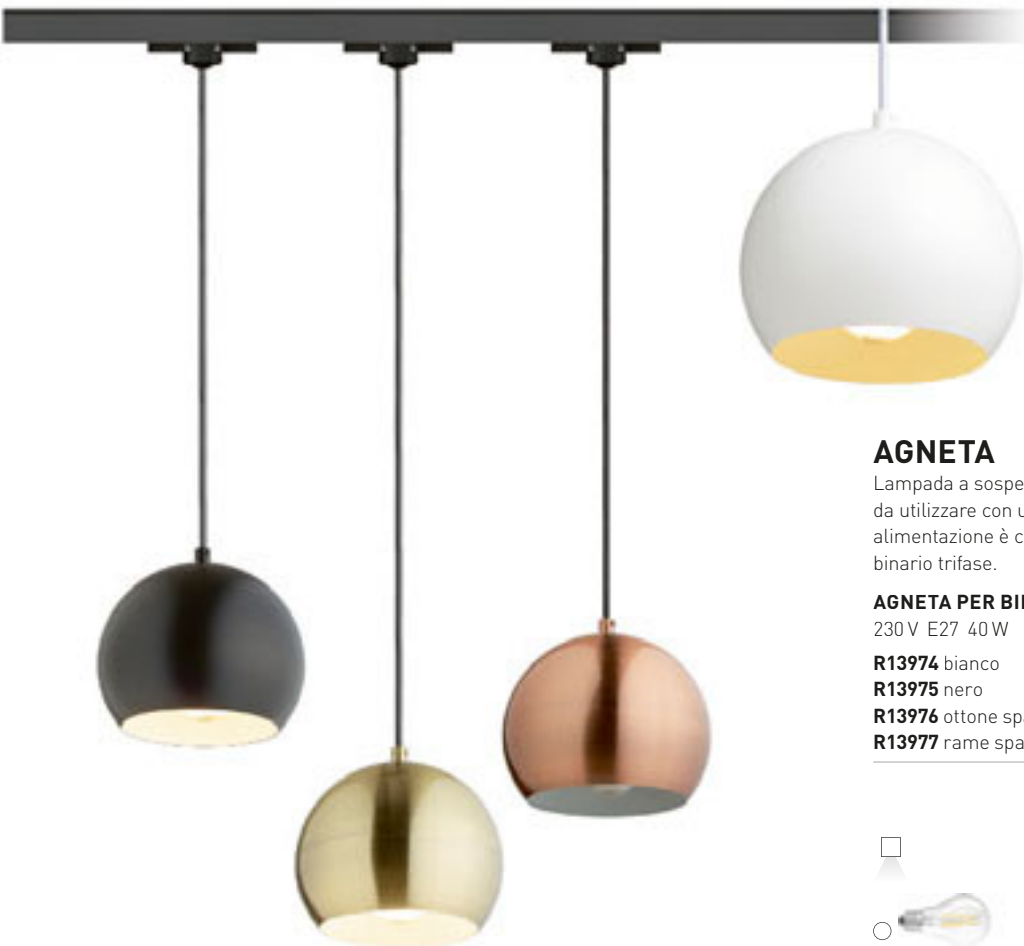

## AGNETA

Lampada a sospensione rotonda in metallo da utilizzare con una lampadina E27. Il cavo di alimentazione è completo di un adattatore finale per binario trifase.

### AGNETA PER BINARIO TRIFASE A SOSPENSIONE

230 V E27 40 W

**R13974** bianco

€ 98

NEW

**R13975** nero

€ 98

NEW

**R13976** ottone spazzolato

€ 120

NEW

**R13977** rame spazzolato

€ 120

NEW

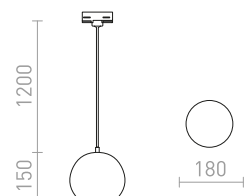





## ASTON

Lampada a sospensione in metallo con un adattatore per binario trifase.

### ASTON PER BINARIO TRIFASE

230 V E27 42 W

R12100 alluminio spazzolato

€ 98 %

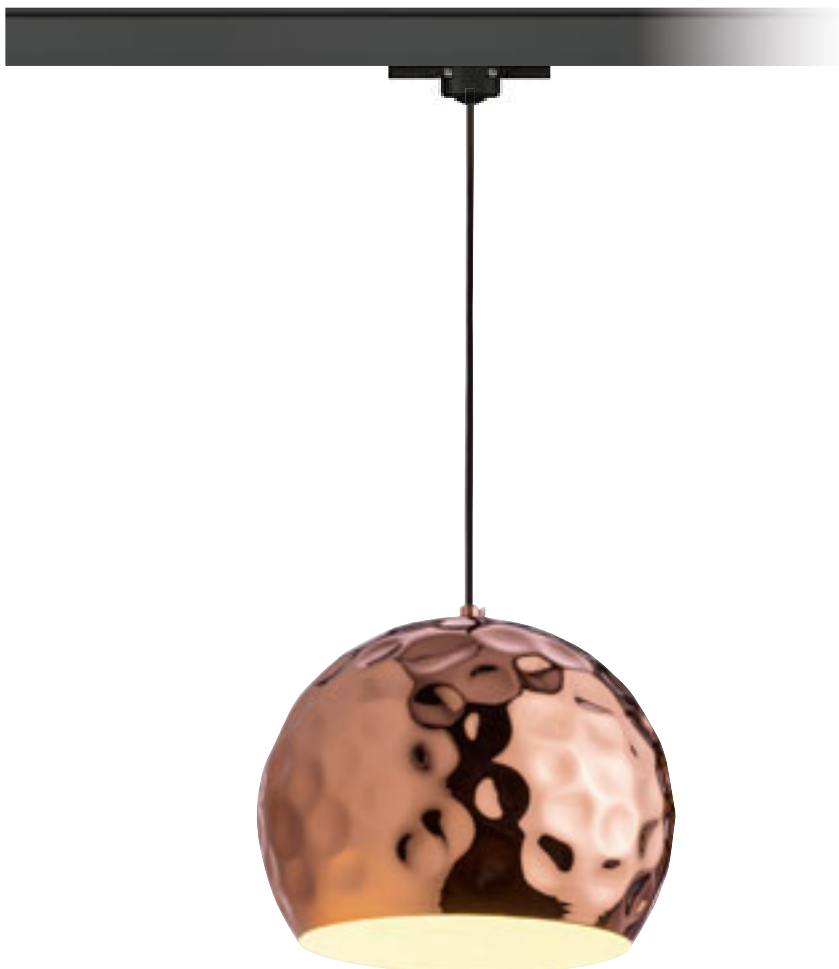
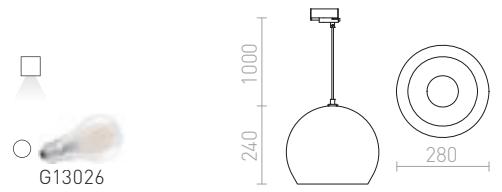

## BLONDIE

Apparecchio a sospensione con paralume in metallo ammaccato. L'esterno del paralume è di color rame e l'interno è laccato in bianco. Cavo in PVC nero è completo di un adattatore finale per binario trifase.

### BLONDIE 25 PER BINARIO TRIFASE

230 V E27 42 W

R13218 rame

€ 229

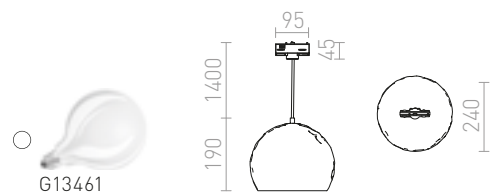



## MONROE

Apparecchio a sospensione con paralume metallico e adattatore per binario trifase.

### MONROE 30 PER BINARIO TRIFASE

230 V E27 42 W

**R12101** nero opaco/bianco

€ 178

**R13819** rame

€ 138

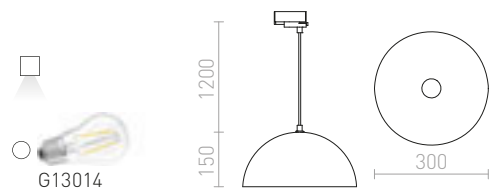



## SINTRA

Lampada a sospensione con paralume in metallo cromato con un adattatore per binario trifase.

### SINTRA 30 PER BINARIO TRIFASE

230 V E27 42 W

R12102 cromo

€ 120 %

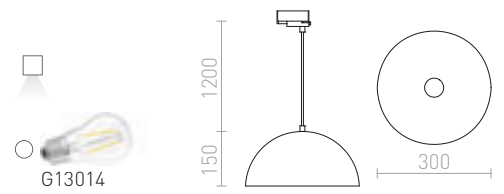

## BUCKY

Lampada a sospensione in metallo con decoro stropicciato. Il cavo di alimentazione è completo di un adattatore finale per binario trifase.

### BUCKY 40 PER BINARIO TRIFASE

230 V E27 28 W

R13859 bianco/grigio/metallo

€ 178

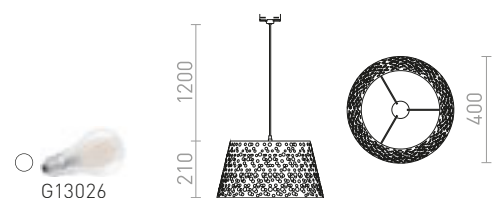



## MAVRO

Faretto a sospensione LED a tubo elegante, adatto per posizionare sopra i banconi del bar e le isole della cucina. Il cavo di alimentazione è completo di un adattatore finale per binario trifase.

### MAVRO PER BINARIO TRIFASE A SOSPENSIONE

230 V LED 12 W  $\angle 38^\circ$  3000 K 1020 lm Ra 80

**R13983** bianco

€ 150

NEW

**R13984** oro

€ 150

NEW

**R13985** nero/oro

€ 150

NEW

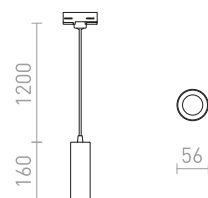



## BELENOS

Faretto cilindrico semplice sospeso, per sorgenti luminose con portalampada GU10. Le molle fissate alla base consentono l'uso di sorgenti luminose di varie lunghezze. Il cavo di alimentazione è completo di un adattatore finale per binario trifase.

**BELENOS PER BINARIO TRIFASE A SOSPENSIONE**  
230 V LED GU10 9 W

**R13857** bianco € 88  
**R13858** nero € 88

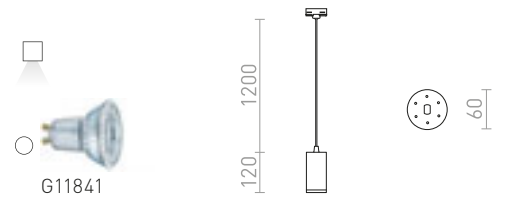

## BABADES

Apparecchio a sospensione con paralume in cromo o nichel opaco. Il cavo in tessuto nero è completo di un adattatore finale per binario trifase.

**BABADES PER BINARIO TRIFASE**  
230 V GU10 35 W

**R13216** cromo € 88  
**R13217** nichel opaco € 88

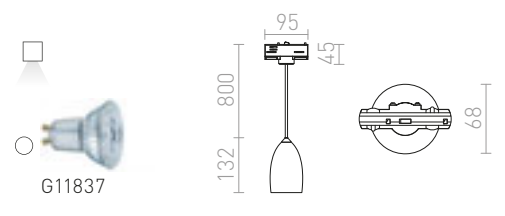

## DESTY

Lampada a sospensione con paralume in metallo e un adattatore finale per binario trifase.

**DESTY PER BINARIO TRIFASE**  
230 V GU10 35 W

**R13215** nero/cromo € 120

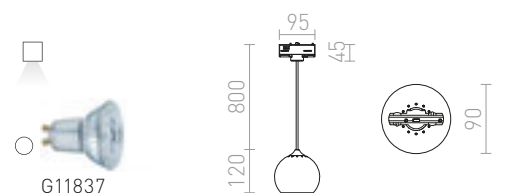





## FRUTTI

Apparecchio a sospensione per sorgente luminosa con portalampada E27. Il cavo di alimentazione è completo di un adattatore finale per binario trifase.

### FRUTTI PER BINARIO TRIFASE

230 V E27 28 W

**R13818** verde/ceramica

**€ 68**

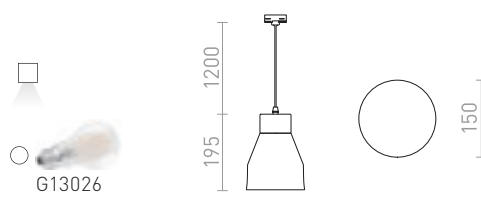

## TUTTI

Apparecchio a sospensione, conico con illuminazione verso il basso, adatto per sorgente luminosa con portalampada E27. Il cavo di alimentazione è completo di un adattatore finale per binario trifase.

### TUTTI PER BINARIO TRIFASE

230 V E27 15 W

**R13817** arancio/ceramica

**€ 88**

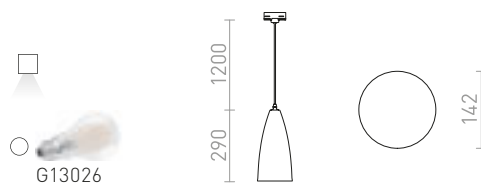



## BURTON

Lampada a sospensione in calcestruzzo con paralume in filo metallico, adatto per sorgente luminoso con portalampada E27. Il cavo di alimentazione è terminato con un adattatore per binario trifase.

### BURTON PER BINARIO TRIFASE

230 V E27 42 W

R13816 calcestruzzo/nero

€ 120

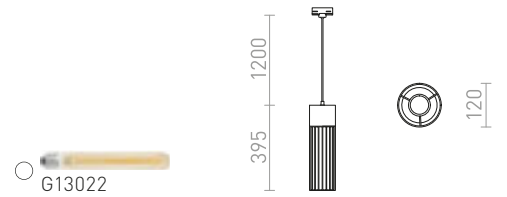

## JACK

Lampada a sospensione in gesso per lampadine con portalampada GU10. Con un adattatore finale per binario trifase.

### JACK RC PER BINARIO TRIFASE

230 V GU10 35 W

R12103 gesso

€ 88 %





R12106  
€ 78

R12107  
€ 98

R12108  
€ 78

R12109  
€ 78

R12110  
€ 78

R12111  
€ 78

R12112  
€ 88

R12113  
€ 88

R12114  
€ 98



## ELISA

Cavo in tessuto in varie combinazioni di colore con portalampada E27 in metallo, da utilizzare con lampadina decorativa o paralume adatto. Il cavo è completo di un adattatore finale per binario trifase.

### ELISA PER BINARIO TRIFASE

230V E27 28 W

|        |      |
|--------|------|
| R12106 | € 78 |
| R12107 | € 98 |
| R12108 | € 78 |
| R12109 | € 78 |
| R12110 | € 78 |
| R12111 | € 78 |
| R12112 | € 88 |
| R12113 | € 88 |
| R12114 | € 98 |

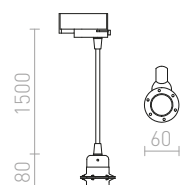



## 1F BINARIO

Binario monofase per installazioni da parete/ da soffitto o a sospensione.

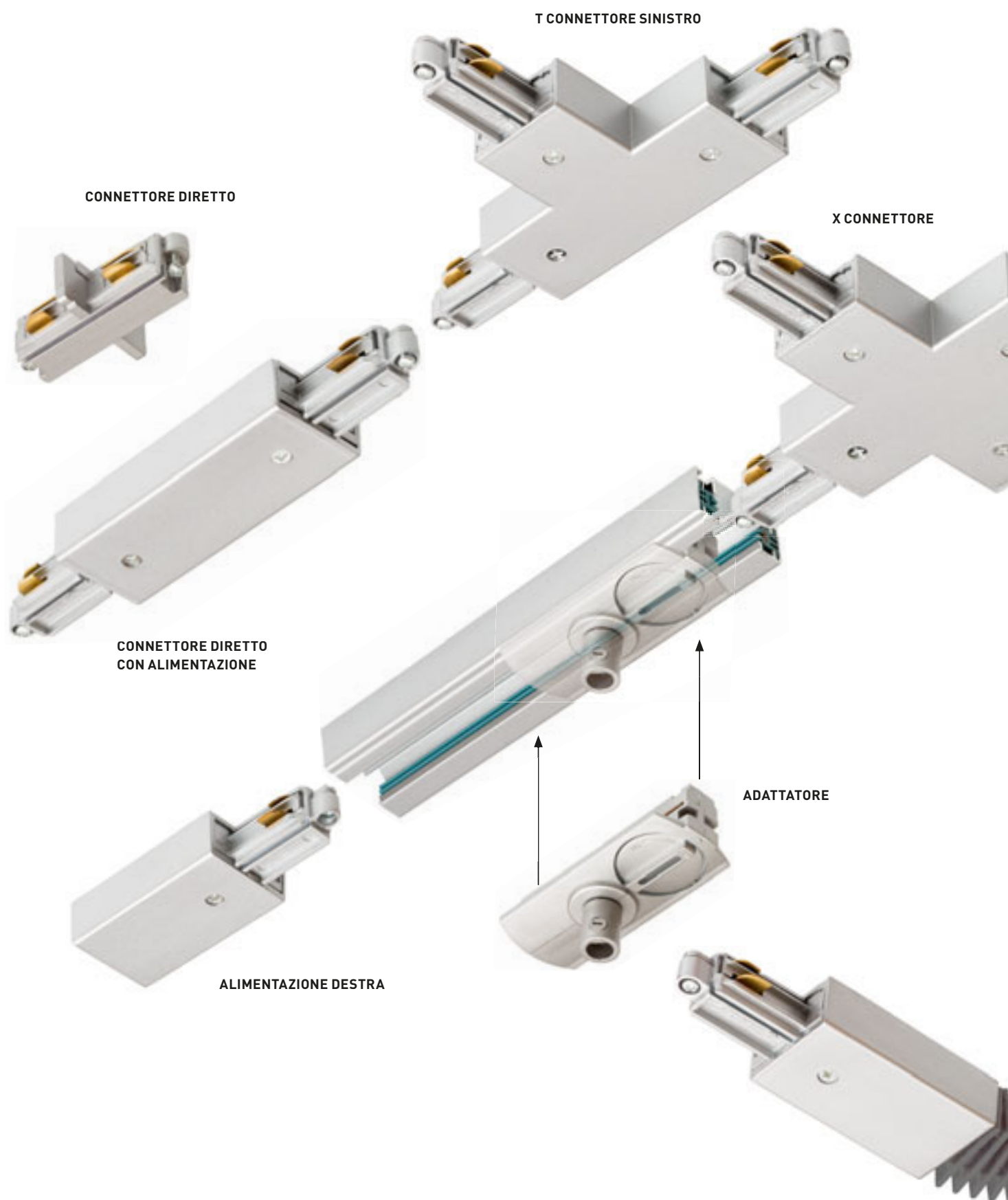



COPERTURA TERMINALE

1F BINARIO

2M CAVO DI SOSPENSIONE

L CONNETTORE INTERNO

CONNETTORE FLEX

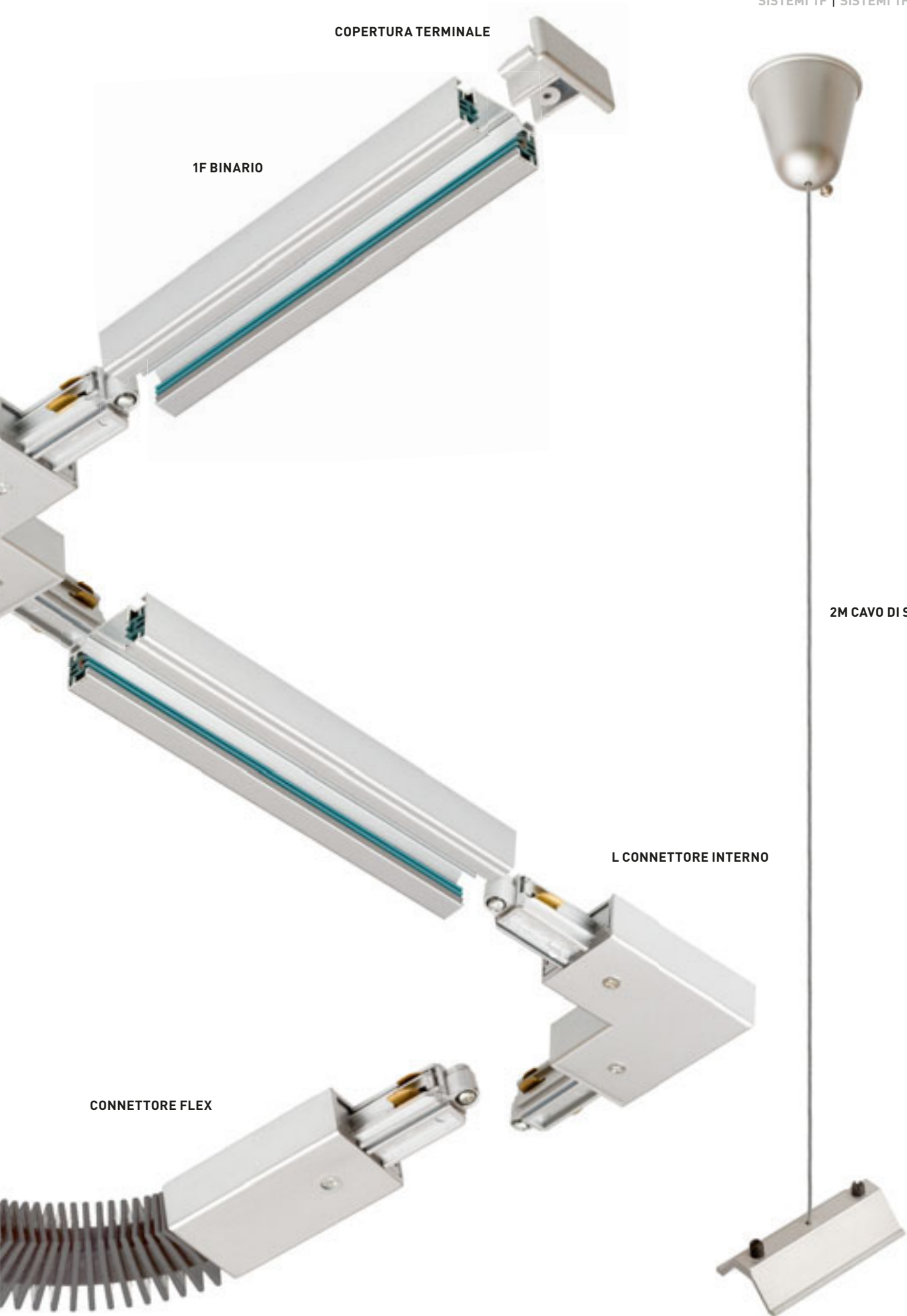

## 1F BINARIO

Binario monofase per installazioni da parete/ da soffitto o a sospensione.



## 2M BINARIO

Binario monofase per sistema scorrevole da parete o a sospensione.

230 V

|                              |                |
|------------------------------|----------------|
| <b>R12257</b> bianco         | <b>€ 78.00</b> |
| <b>R12258</b> nero           | <b>€ 78.00</b> |
| <b>R12259</b> grigio argento | <b>€ 78.00</b> |



## 1M BINARIO

Binario monofase per installazioni da parete/ da soffitto o a sospensione.

230 V

|                              |             |
|------------------------------|-------------|
| <b>R12254</b> bianco         | <b>€ 38</b> |
| <b>R12255</b> nero           | <b>€ 38</b> |
| <b>R12256</b> grigio argento | <b>€ 38</b> |



## CONNETTORE DIRETTO CON ALIMENTAZIONE

Connettore diretto con alimentazione. Carica massima 16A.

230 V

|                              |               |
|------------------------------|---------------|
| <b>R12263</b> bianco         | <b>€ 9.50</b> |
| <b>R12264</b> nero           | <b>€ 9.50</b> |
| <b>R12265</b> grigio argento | <b>€ 9.35</b> |



## X CONNETTORE

Connettore a X con alimentazione per binario monofase. Carica massima 16A.

230 V

|                              |                |
|------------------------------|----------------|
| <b>R12278</b> bianco         | <b>€ 18.50</b> |
| <b>R12279</b> nero           | <b>€ 18.50</b> |
| <b>R12280</b> grigio argento | <b>€ 18</b>    |

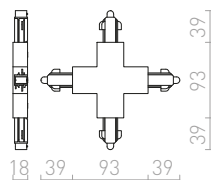

## CONNETTORE DIRETTO

Giunto conduttivo per binari monofase.

230 V

|                              |               |
|------------------------------|---------------|
| <b>R12260</b> bianco         | <b>€ 5.20</b> |
| <b>R12261</b> nero           | <b>€ 5.35</b> |
| <b>R12262</b> grigio argento | <b>€ 5.20</b> |

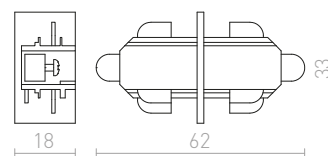

## CONNETTORE FLEX

Giunto flessibile per binario monofase. Raggio di curvatura 70°-180°. Carica massima 16A.

230 V

|                              |                |
|------------------------------|----------------|
| <b>R12281</b> bianco         | <b>€ 16.50</b> |
| <b>R12282</b> nero           | <b>€ 16.50</b> |
| <b>R12283</b> grigio argento | <b>€ 17.50</b> |

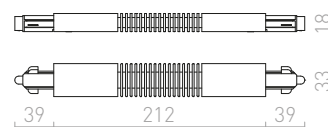



### L CONNETTORE INTERNO

Connettore a L con alimentazione per binario monofase. Carica massima 16A.

230 V  
**R12269** bianco € 10.50  
**R12270** nero € 10.50  
**R12271** grigio argento € 9.80

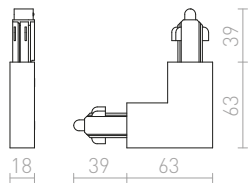

### L CONNETTORE ESTERNO

Connettore a L con alimentazione per binario monofase. Carica massima 16A.

230 V  
**R12266** bianco € 9.80  
**R12267** nero € 9.80  
**R12268** grigio argento € 9.80

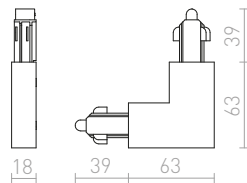

### ADATTATORE

Adattatore per binario monofase. Con questo adattatore è possibile di sospendere su sistema qualsiasi lampada a sospensione con unico cavo (non adatto per apparecchio su cavo di acciaio e cavo elettrico separati). Carica massima 16A. Carico meccanico massimo 20N.

230 V  
**R12293** bianco € 9.50  
**R12294** nero € 9.50  
**R12295** grigio argento € 9.50

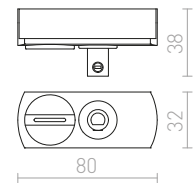

### T CONNETTORE SINISTRO

Connettore a T con alimentazione per binario monofase. Carica massima 16A.

230 V  
**R12272** bianco € 12.50  
**R12273** nero € 12.50  
**R12274** grigio argento € 13

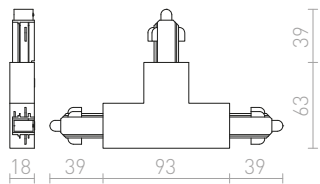

### T CONNETTORE DESTRO

Connettore a T con alimentazione per binario monofase. Carica massima 16A.

230 V  
**R12275** bianco € 12.50  
**R12276** nero € 13  
**R12277** grigio argento € 13

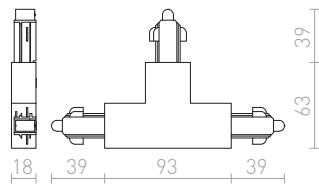

### 2M CAVO DI SOSPENSIONE

Cavo di sospensione per binario monofase.

**R12296** bianco € 8.25  
**R12297** nero € 8.25  
**R12298** grigio argento € 8.25

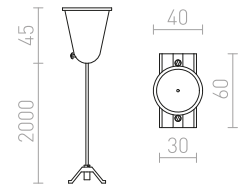

### ALIMENTAZIONE SINISTRA

Alimentazione per binari monofase. Carica massima 16A.

230 V  
**R12284** bianco € 5.20  
**R12285** nero € 5.20  
**R12286** grigio argento € 5.20

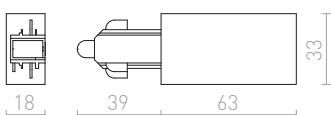

### ALIMENTAZIONE DESTRA

Alimentazione per binari monofase. Carica massima 16A.

230 V  
**R12287** bianco € 5.20  
**R12288** nero € 5.20  
**R12289** grigio argento € 5.20

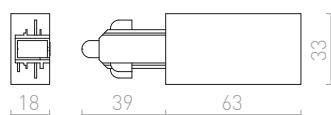

### COPERTURA TERMINALE

Copertura terminale per binario monofase.

**R12290** bianco € 1.35  
**R12291** nero € 1.35  
**R12292** grigio argento € 1.35

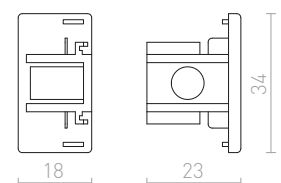



## FOCUS

Lampada tubolare dimmerabile per binario monofase con possibilità di regolare il cono di luce tramite il sistema zoom 10 - 60°. Tramite l'interruttore sulla lampada è possibile impostare il colore della luce: 3000K, 4000K, 5000K. Dimmerazione del TRIAC.

### FOCUS 12 DIMM PER BINARIO MONOFASE

230 V LED 12 W  $\angle 10-60^\circ$  3000 K 4000 K 5000 K  
780 lm Ra 80

**R13878** bianco

€ 88 NEW

**R13879** nero

€ 88 NEW

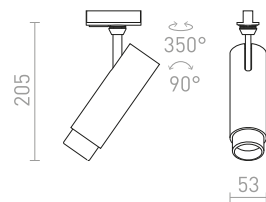

### FOCUS 20 DIMM PER BINARIO MONOFASE

230 V LED 20 W  $\angle 10-60^\circ$  3000 K 4000 K 5000 K  
1540 lm Ra 80

**R13880** bianco

€ 120 NEW

**R13881** nero

€ 120 NEW

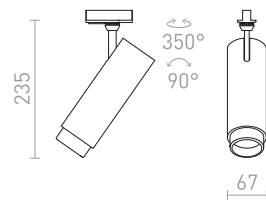



## OPTIMUS

Apparecchio cilindrico adatto per il binario monofase con la possibilità di regolare il cono di luce tramite il sistema di zoom 10-50°. L'apparecchio è adatto per sorgenti luminose LED con portalampada GU10. Da usare con sorgenti luminose con fascio di luce di 120° per evitare ombre indesiderate.

### OPTIMUS PER BINARIO MONOFASE

230 V LED GU10 9 W  $\angle 10-50^\circ$

**R13781** bianco

€ 58

**R13782** nero

€ 58



G12232

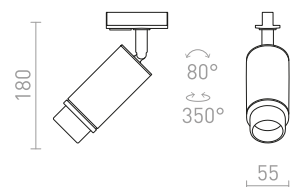





## MAVRO

Faretto LED a tubo, adatto per binario monofase.  
Dimmerazione TRIAC.

### MAVRO DIMM PER BINARI MONOFASE

230 V LED 12 W  $\angle 38^\circ$  3000 K 1020 lm Ra 80

**R13163** nero/oro

€ 150

**R13446** bianco

€ 150

**R13849** oro

€ 150

NEW

- LED
- dimmerabile

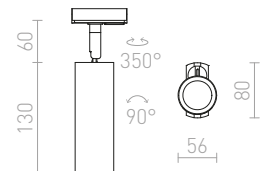

## MAVRO

Faretto cilindrico con LED integrato per binario monofase.

### MAVRO PER BINARI MONOFASE

230 V LED 12 W  $\angle 38^\circ$  3000 K 1020 lm Ra 80

**R12993** bianco

€ 120

**R12994** nero/oro

€ 120

**R13848** oro

€ 120

NEW

- LED
- dimmerabile

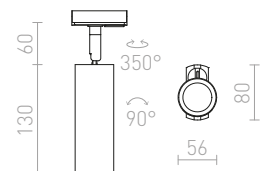



## WISH

Apparecchio cilindrico dimmerabile per binario monofase con possibilità di impostare il colore di luce: bianco caldo (WW), bianco neutro (NW), bianco freddo (CW). Dimmerazione TRIAC.

### WISH 20 DIMM PER BINARIO MONOFASE

230 V LED 20 W  $\angle 36^\circ$  3000 K 4000 K 5000 K  
1600 lm Ra 80

R13769 bianco

€ 98

NEW

R13770 nero

€ 98

NEW

● LED  
● dimmerabile

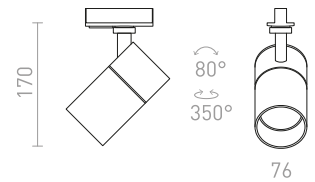

### WISH 30 DIMM PER BINARIO MONOFASE

230 V LED 30 W  $\angle 36^\circ$  3000 K 4000 K 5000 K  
2400 lm Ra 80

R13771 bianco

€ 120

NEW

R13772 nero

€ 120

NEW

● LED  
● dimmerabile

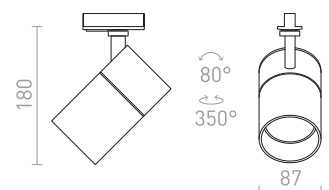



## DUDE

Riflettore cilindrico per binario monofase per sorgente luminosa a LED con attacco GU10.

### DUDE PER BINARIO MONOFASE

230 V LED GU10 9 W

R13926 bianco

€ 58 **NEW**

R13927 nero

€ 58 **NEW**

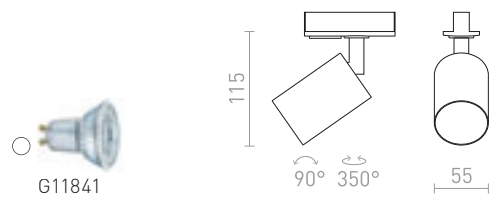

## BELENOS

Faretto cilindrico semplice, per sorgenti luminose con portalampada GU10 per binario monofase. Le molle fissate alla base consentono l'uso di sorgenti luminose di varie lunghezze.

### BELENOS PER BINARIO MONOFASE

230 V LED GU10 9 W

R13367 bianco

€ 68

R13369 nero

€ 68

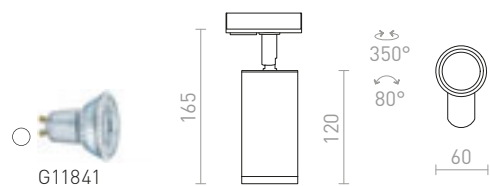



## FORZA

Faretto cilindrico con portalampada GU10 per binari monofase.

### FORZA PER BINARIO MONOFASE

230 V LED GU10 10 W

R13350 bianco

€ 78

R13351 nero

€ 78

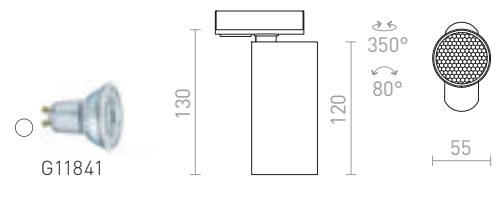

## CADENZA

Faretto cilindrico con portalampada GU10 per binari monofase.

### CADENZA PER BINARIO MONOFASE

230 V LED GU10 10 W

R13346 bianco

€ 68

R13347 nero

€ 68

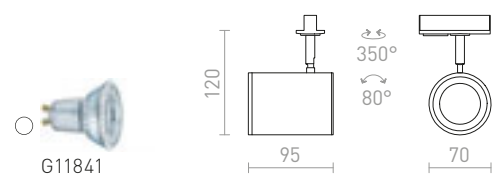



## DARIO

Faretto cilindrico per binario monofase e lampadina LED con attacco GU10 comprensivo di anello decorativo in metallo in colore ottone spazzolato. Per cambiare colore è possibile acquistare un anello bianco o nero.

### DARIO PER BINARIO MONOFASE

230 V GU10 9 W

**R13870** bianco/ottone spazzolato

€ 78

NEW

**R13871** nero/ottone spazzolato

€ 78

NEW

**R13872** ottone spazzolato

€ 88

NEW

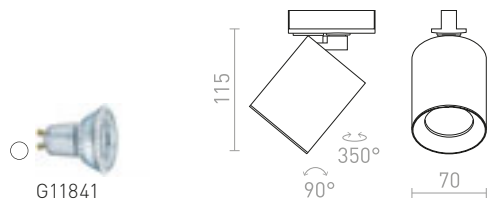
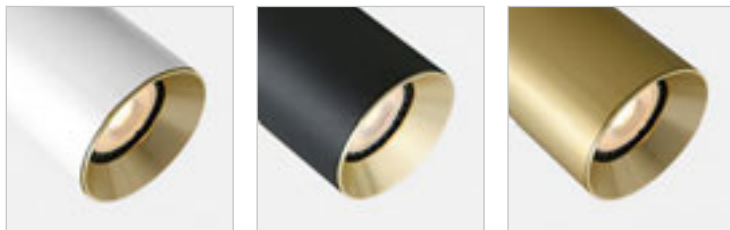

## DARIO

Anello decorativo in alluminio per la possibilità di cambiare il colore delle lampade DARIO.

### DARIO ANELLO DECORATIVO

**R13876** bianco

€ 8.50

NEW

**R13877** nero

€ 8.50

NEW

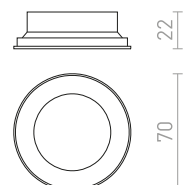
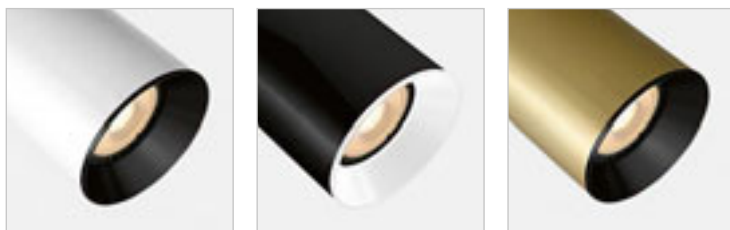





## CONNOR

Faretto cilindrico con portalampada GU10 per binario monofase.

### CONNOR PER BINARIO MONOFASE

230 V LED GU10 10 W

R13497 bianco/nero

€ 58

R13498 nero/oro

€ 58

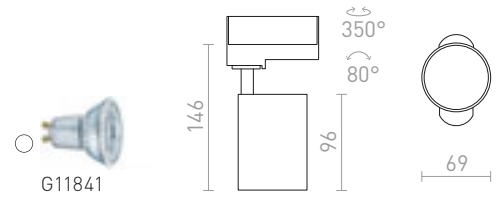

## SIENA

Apparecchio per binario monofase in due varianti di colore, per sorgenti luminose con portalampada GU10.

### SIENA PER BINARIO MONOFASE

230 V GU10 50 W

R13759 bianco

€ 78

NEW

R13760 nero

€ 78

NEW

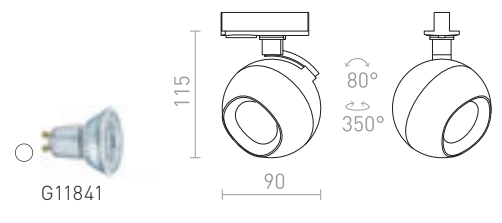

## LALA

Riflettore cilindrico per binario monofase adatto per sorgenti luminose con portalampada GU10.

### LALA PER BINARIO MONOFASE

230 V GU10 50 W

R13767 nero/ottone

€ 58

NEW

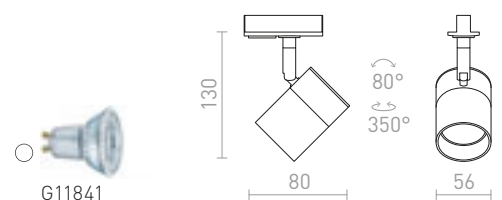



## BEEBA

Apparecchio per binario monofase in due varianti di colore.

### BEEBA I PER BINARIO MONOFASE

230 V GU10 35 W

R12308 bianco

€ 58

R12310 nero

€ 58

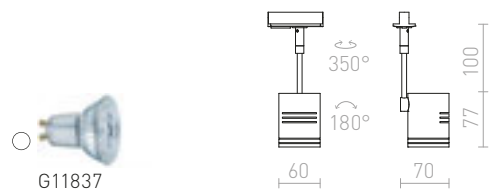

### BEEBA II PER BINARIO MONOFASE

230 V GU10 2x35 W

R12314 bianco

€ 88

R12316 nero

€ 88

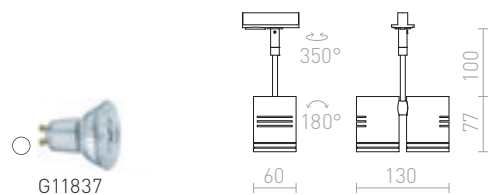



## PURINA

Riflettore con portalampana GU10 per binario monofase disponibile in tre colori. Fornito con anello decorativo per sorgenti luminose con riflettori da 51 mm. Possono essere utilizzate anche sorgenti luminose ES111.

### PURINA PER BINARIO MONOFASE

230 V GU10 50 W

**R12320** bianco

€ 48

**R12321** grigio argento

€ 32

**R12322** nero

€ 48



G11841

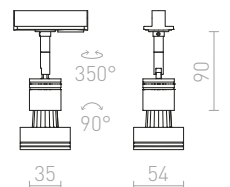

## TRICA

Apparecchio per binario monofase con portalampana GU10. Adatto per sorgenti luminose con diametro di 111 mm oppure 51 mm. Le dimensioni del prodotto sono indicate senza sorgente luminosa.

### TRICA PER BINARIO MONOFASE

230 V GU10 50 W

**R12977** bianco

€ 29

**R12978** nero

€ 29



G12723

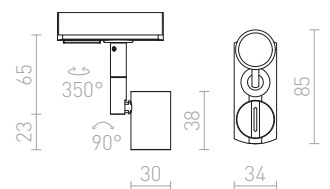



## COPA

Apparecchio a sospensione con paralume in vetro.  
Disponibile in due colori. Con adattatore per binario monofase.

### COPA PER BINARI MONOFASE

230 V E27 28 W

**R13205** vetro opalino

€ 178

**R13206** nero/vetro

€ 188

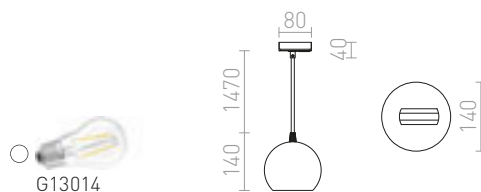

## LUNA

Lampada a sospensione in vetro opalino con finiture cromate e cavo trasparente. Il cavo di alimentazione è completo di un adattatore finale per binario monofase.

### LUNA 20 PER BINARIO MONOFASE

230 V LED E27 15 W

**R13964** vetro opalino/cromo

€ 120

NEW

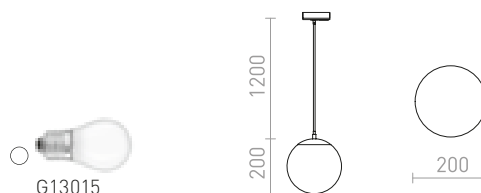

### LUNA 25 PER BINARIO MONOFASE

230 V LED E27 15 W

**R13965** vetro opalino/cromo

€ 178

NEW

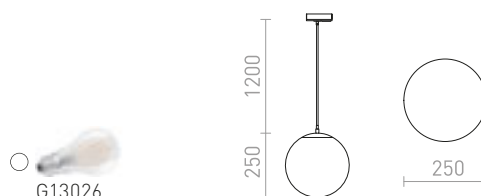

### LUNA 30 PER BINARIO MONOFASE

230 V E27 15 W

**R13966** vetro opalino/cromo

€ 215

NEW

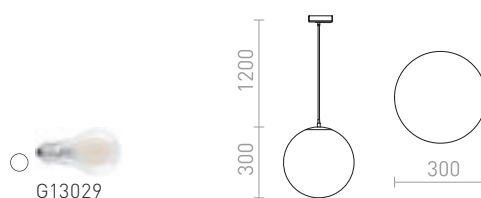







## ARAQ

Apparecchio a sospensione con portalampada in ottone, cavo tessile rifinito con un adattatore per binario monofase. Adatto per lampadina decorativa con attacco E27.

### ARAQ PER BINARIO MONOFASE A SOSPENSIONE

230 V E27 42 W

R13978 ottone spazzolato/nero

€ 48 **NEW**

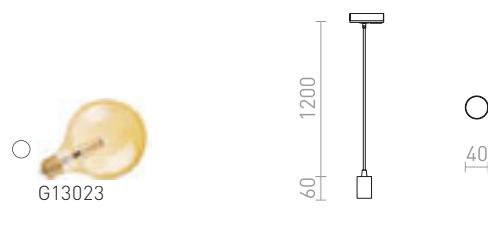

## BELLINI

Lampada a sospensione in vetro con accessori laccati, adatta per sorgente luminosa LED con portalampada E14. Il cavo di alimentazione è completo di un adattatore finale per binario monofase.

### BELLINI L E14 PER BINARIO MONOFASE A SOSPENSIONE

230 V E14 15 W

R13963 bianco/vetro trasparente

€ 188 **NEW**

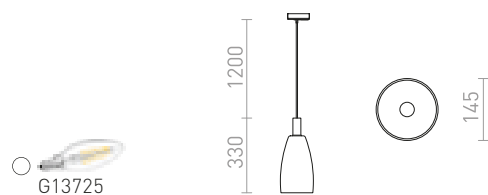



## PULIRE

Lampada a sospensione in vetro bianco latte con adattatore per binario monofase.

### PULIRE CON PER BINARIO MONOFASE

230 V E14 28 W

**R13209** vetro opalino/legno

€ 120

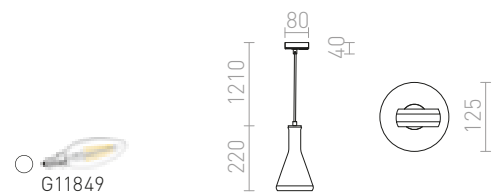

### PULIRE RD PER BINARIO MONOFASE

230 V E14 28 W

**R13210** vetro opalino/legno

€ 120

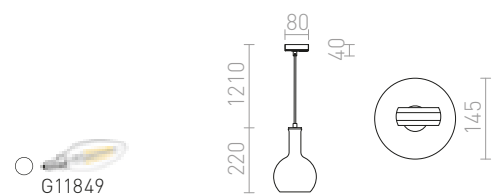



## JULIETTA

Lampada di design a sospensione con vetro cilindrico opalino. Elementi in metallo verniciato, cavo di tessuto nero. Il cavo di alimentazione è completo di un adattatore finale per binario monofase.

### JULIETTA 16 PER BINARIO MONOFASE

230 V E27 20 W

R13860 vetro opalino/nero

€ 129

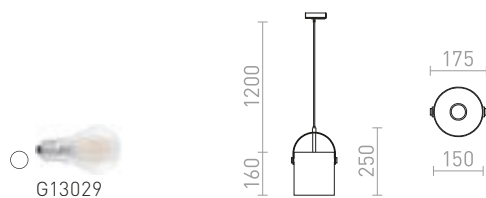

### JULIETTA 31 PER BINARIO MONOFASE

230 V E27 20 W

R13861 vetro opalino/nero

€ 178

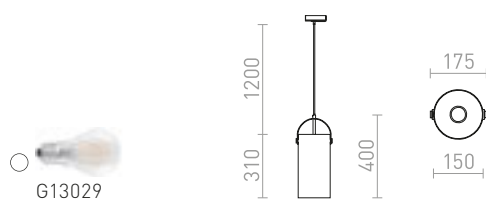



## GIULIA

Lampada a sospensione in metallo verniciato con cavo di tessuto. Il cavo di alimentazione è completo di un adattatore finale per binario monofase.

### GIULIA 12 PER BINARIO MONOFASE

230 V E27 40 W

**R13986** bianco/cromo

€ 68 NEW

**R13987** nero/marrone dorato/ottone

€ 68 NEW

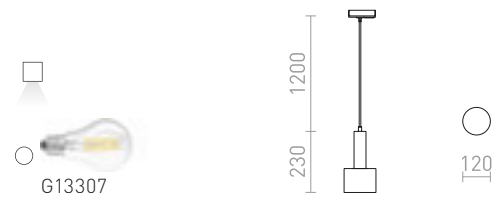

### GIULIA 20 PER BINARIO MONOFASE

230 V E27 40 W

**R13988** bianco/cromo

€ 78 NEW

**R13989** nero/marrone dorato/ottone

€ 88 NEW

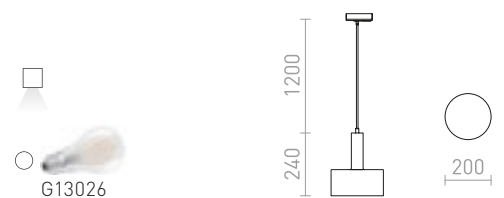



## CHOUPETTE

Apparecchio a sospensione tessile con decorazione in legno, compatibile con sorgente LED E27. Per installazione su binario monofase.

### CHOUPETTE PER BINARIO MONOFASE

230 V E27 15 W

R13720 grigio nerastro/tessuto/legno

€ 129

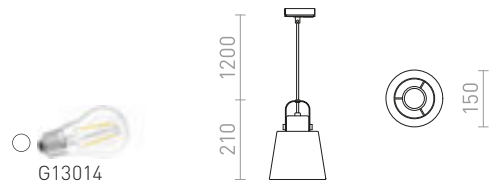

## BABADES

Apparecchio a sospensione con paralume in cromo o nichel opaco. Il cavo in tessuto nero è completo di un adattatore finale per binario monofase.

### BABADES PER BINARIO MONOFASE

230 V GU10 35 W

R13212 cromo

€ 68

R13213 nichel opaco

€ 68

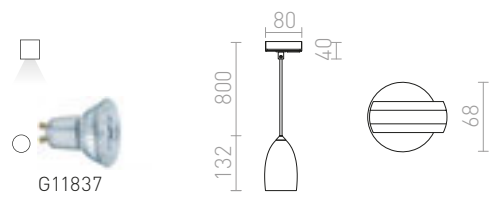

## ICAR

Lampada a sospensione minimalista con paralume in tessuto. Cavo in tessuto nero è completo di un adattatore finale per binario monofase.

### ICAR PER BINARIO MONOFASE

230 V E27 15 W

R13214 nero/oro

€ 120 →

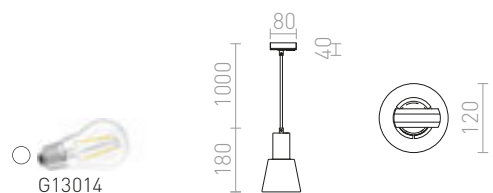





## MAVRO

Faretto a sospensione LED a tubo elegante, adatto per posizionare sopra i banconi del bar e le isole della cucina. Il cavo di alimentazione è completo di un adattatore finale per binario monofase.

### MAVRO PER BINARIO MONOFASE A SOSPENSIONE

230 V LED 12 W  $\angle 38^\circ$  3000 K 1020 lm Ra 80

R13980 bianco

€ 120 NEW

R13981 oro

€ 120 NEW

R13982 nero/oro

€ 120 NEW

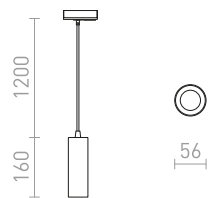

## BELENOS

Faretto cilindrico semplice sospeso, per sorgenti luminose con portalampada GU10. Le molle fissate alla base consentono l'uso di sorgenti luminose di varie lunghezze. Il cavo di alimentazione è completo di un adattatore finale per binario monofase.

### BELENOS PER BINARIO MONOFASE A SOSPENSIONE

230 V LED GU10 9 W

R13862 bianco

€ 68

R13863 nero

€ 68



G11841

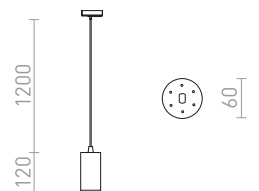



## AGNETA

Lampada a sospensione rotonda in metallo da utilizzare con una lampadina E27. Il cavo di alimentazione è completo di un adattatore finale per binario monofase.

### AGNETA PER BINARIO MONOFASE A SOSPENSIONE

230 V E27 40 W

**R13970** bianco

€ 68

NEW

**R13971** nero

€ 68

NEW

**R13972** ottone spazzolato

€ 98

NEW

**R13973** rame spazzolato

€ 98

NEW

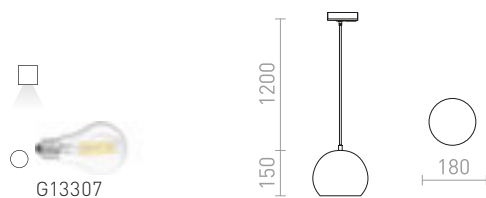



## DESTY

Lampada a sospensione con paralume in metallo e un adattatore finale per binario monofase.

### DESTY PER BINARIO MONOFASE

230 V GU10 35 W

R13211 nero/cromo

€ 88

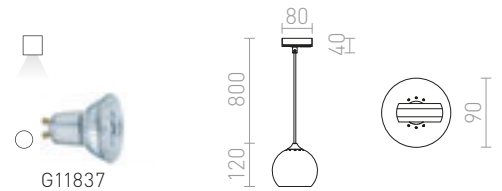

## BLONDIE

Apparecchio a sospensione con paralume in metallo ammaccato. L'esterno del paralume è di color rame e l'interno è laccato in bianco. Cavo in PVC nero è completo di un adattatore finale per binario monofase.

### BLONDIE 25 PER BINARIO MONOFASE

230 V E27 42 W

R13726 rame

€ 215

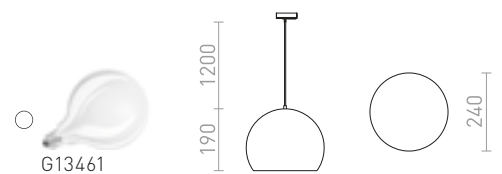

## ELISA

Cavo in tessuto in varie combinazioni di colore con portalampada E27 in metallo, da utilizzare con lampadina decorativa. Il cavo è completo di un adattatore finale per binario monofase.

### ELISA PER BINARIO MONOFASE

230 V E27 28 W

R13201

€ 58

R13202

€ 58

R13203

€ 58

R13204

€ 68

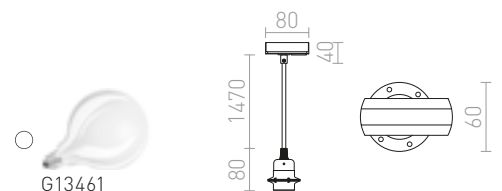

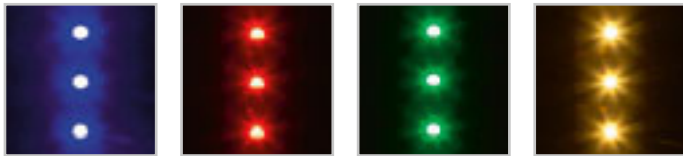

## STRISCIA LED ORION

Striscia LED RGBW con possibilità di impostare la luce colorata o bianca con varie temperature di colori (3000K - 450lm/m). Fornita in una confezione da 5 m, divisibile per 5 cm, con un nastro biadesivo sul retro. È necessario di completare con driver G13804 che include un telecomando o le strisce LED possono essere controllate utilizzando Amazon Alexa, Google Assistant, le app Smart Life o Tuya Smart il telecomando che viene fornito con esso.

### LED STRIP ORION RGBW STRISCIA LED 5M

12V= LED 96 W  $\angle 120^\circ$  RGBW up to 2250 lm Ra 80

G13820

€ 58

LED



5000x12 mm



## STRISCIA LED ORION

Striscia LED RGB con la possibilità di impostare i vari colori della luce. Fornita in una confezione da 5 metri, divisibile per 5 cm con nastro biadesivo sul retro. È necessario di completare con driver G13804 che include un telecomando, o le strisce LED possono essere controllate tramite Amazon Alexa, Google Assistant o le app Smart Life o Tuya Smart oppure con il telecomando che viene fornito con esso.

### LED STRIP ORION RGB STRISCIA LED 5M

12V= LED 72 W  $\angle 120^\circ$  RGB 2250 lm Ra 80

G13800

€ 38 →

LED



5000x10 mm

## LED STRIP ORION WI-FI DRIVER 5IN1

Wi-fi 5 in 1 telecomando. Le strisce LED possono essere controllate tramite Amazon Alexa, Google Assistant, le app Smart Life o Tuya Smart. L'unità di controllo funziona solo sulla frequenza di 2,4 GHz. Un telecomando autonomo è incluso. Il telecomando wi-fi può controllare le strisce LED RGB o dimmerare le strisce LED monocolori G13798, G13799.

G13804

€ 24

**LED STRIP ORION 60 DRIVER**

Driver LED 60W 12V per alimentazione di strisce LED.

230 V/12 V= 60 W IP67

**G13801****€ 22**

25x202x35 mm

**LED STRIP ORION 100 DRIVER**

Driver LED 100W 12V per alimentazione di strisce LED.

230 V/12 V= 100 W IP67

**G13802****€ 29**

35x178x53 mm

**LED STRIP ORION 150 DRIVER**

Driver LED 150W 12V per alimentazione di strisce LED.

Il driver dispone di due connettori secondari.

230 V/12 V= 150 W IP67

**G13803****€ 48**

33x199x61 mm





## STRISCIA LED ORION

Striscia COB LED ad alta potenza luminosa. Illumina uniformemente per tutta la sua lunghezza senza punti singoli. Fornita in una confezione da 5 metri, divisibile per 0,75 cm con nastro biadesivo sul retro. Deve essere completata da un driver adeguato. Dimmerabile con il driver G13804. 3000K - 950lm/m; 4000K - 1000lm/m

### LED STRIP ORION STRISCIA LED 5M

12V= LED 50 W  $\angle 120^\circ$  3000 K 2375 lm Ra 80

G13798

€ 58



5000x8 mm

### LED STRIP ORION STRISCIA LED 5M

12V= LED 50 W  $\angle 120^\circ$  4000 K 2500 lm Ra 80

G13799

€ 58



5000x8 mm



## LED STRIP ORION WI-FI DRIVER 5IN1

Wi-fi 5 in 1 telecomando. Le strisce LED possono essere controllate tramite Amazon Alexa, Google Assistant, le app Smart Life o Tuya Smart. L'unità di controllo funziona solo sulla frequenza di 2,4 GHz. Un telecomando autonomo è incluso.

Il telecomando wi-fi può controllare le strisce LED RGB o dimmerare le strisce LED monocolori G13798, G13799.

G13804

€ 24

**LED STRIP ORION 60 DRIVER**

Driver LED 60W 12V per alimentazione di strisce LED.

230 V/12 V= 60 W IP67

**G13801**

**€ 22**



25x202x35 mm

**LED STRIP ORION 100 DRIVER**

Driver LED 100W 12V per alimentazione di strisce LED.

230 V/12 V= 100 W IP67

**G13802**

**€ 29**



35x178x53 mm

**LED STRIP ORION 150 DRIVER**

Driver LED 150W 12V per alimentazione di strisce LED.

Il driver dispone di due connettori secondari.

230 V/12 V= 150 W IP67

**G13803**

**€ 48**



33x199x61 mm



### LED STRIP IP20 5M

Striscia LED adatta per illuminazione decorativa da interni. Fornito in confezione da 5 m, divisibile per 5 cm, con nastro adesivo a coste sul retro. In versione luce calda o fredda, è necessario di completarla con driver e accessori adeguati.

12 V= LED 60W 5000 lm Ra80

**G12366** 3000 K

€ 14

**G12367** 4000 K

€ 14



G13802



5000x8 mm



### LED STRIP IP20 ALIMENTAZIONE

Accessori per LED STRIP IP20 G12366 e G12367.

**G12370**

€ 0.50



150 mm

### LED STRIP IP20 CONNETTORE

Accessori per LED STRIP IP20 G12366 e G12367.

**G12368**

€ 0.80



165 mm

### LED STRIP IP20 CONNETTORE DIRETTO

Accessori per LED STRIP IP20 G12366 e G12367.

**G12369**

€ 0.40



5x16x13 mm

### LED STRIP SORGENTE DI ALIMENTAZIONE

Driver per strisce LED 12V.

230 V/12 V= 72 W

**G12377**

€ 22



42x100x160 mm

**LED STRIP IP54 5M**

Striscia LED adatta per illuminazione decorativa in ambienti umidi. Fornito in confezione da 5 m, divisibile per 5 cm, con un nastro adesivo a coste sul retro. In versione luce calda o fredda. Necessario di completarla con driver e accessori adeguati.

12V= LED 60W 5000lm Ra 80 IP54

**G12371** 3000 K

**€ 24**

**G12372** 4000 K

**€ 24**



G13802



5000x8 mm

**LED STRIP IP54 ALIMENTAZIONE**

Accessori per LED STRIP IP54 G12371 e G12372.

**G12375**

**€ 0.70**



150 mm

**LED STRIP IP54 CONNETTORE**

Accessori per LED STRIP IP54 G12371 e G12372.

**G12373**

**€ 1.20**



165 mm

**LED STRIP IP54 CONNETTORE DIRETTO**

Accessori per LED STRIP IP54 G12371 e G12372.

**G12374**

**€ 0.50**



8x15x14 mm

IP54

**LED STRIP DIMMERATORE CON TELECOMANDO**

Comando a distanza per strisce LED 12V= con funzione dimmerabile, regolazione intensità della luce. Adatto per strisce LED G12366, G12367, G12371 o G12372.

12V= max. 108 W

**G12378** bianco

**€ 48**



G13802



103x54x6 mm





## LED PROFIL

Profilo da parete in alluminio per il posizionamento di una striscia LED adeguata. Fornito con un diffusore opaco e accessori.

### LED PROFILE G 1M AGGIUNTO

|        |                                     |      |     |
|--------|-------------------------------------|------|-----|
| R14086 | bianco/acrilato opaco/alluminio     | € 24 | NEW |
| R14087 | nero/acrilato opaco/alluminio       | € 24 | NEW |
| R14088 | alluminio anodizzato/acrilato opaco | € 18 | NEW |

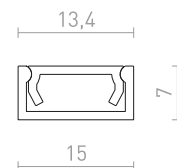

## LED PROFIL

Profilo da parete in alluminio per l'installazione di una striscia LED adeguata. Fornito con un diffusore opaco e accessori.

### LED PROFILE H 1M AGGIUNTO

|        |                                     |      |     |
|--------|-------------------------------------|------|-----|
| R14089 | bianco/acrilato opaco/alluminio     | € 35 | NEW |
| R14090 | nero/acrilato opaco/alluminio       | € 35 | NEW |
| R14091 | alluminio anodizzato/acrilato opaco | € 29 | NEW |

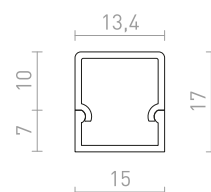

## LED PROFIL

Profilo angolare asimmetrico in alluminio per striscia LED appropriata. A seconda del metodo di montaggio, la luce uscirà con un angolo di 30° o 60°. Fornito con diffusore opaco e accessori.

### LED PROFILE I 30/60 1M AGGIUNTO

|        |                                     |      |     |
|--------|-------------------------------------|------|-----|
| R14092 | alluminio anodizzato/acrilato opaco | € 26 | NEW |
|--------|-------------------------------------|------|-----|

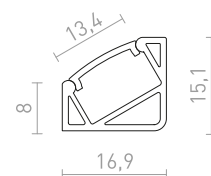





## LED PROFIL

Profilo angolare in alluminio per l'installazione di strisce LED adatte. Nel profilo possono essere inserite fino a tre strisce LED di 8 mm di larghezza o due strisce LED di 12 mm di larghezza. Fornito con un diffusore opaco e accessori.

### LED PROFILE J 1M AGGIUNTO

|   |              |     |
|---|--------------|-----|
| <b>R14093</b> bianco/acrilato opaco/alluminio     | <b>€ 120</b> | NEW |
| <b>R14094</b> nero/acrilato opaco/alluminio       | <b>€ 120</b> | NEW |
| <b>R14095</b> alluminio anodizzato/acrilato opaco | <b>€ 98</b>  | NEW |

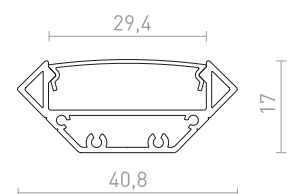



## LED PROFIL

Profilo in alluminio da utilizzare con striscia LED adatta. Fornito con diffusore opaco ed accessori.

### LED PROFILE A DA INCASSO 1M

R13864 alluminio/acrilico

€ 26

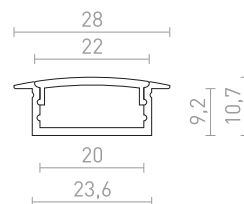

↑ 9  
 1000x24

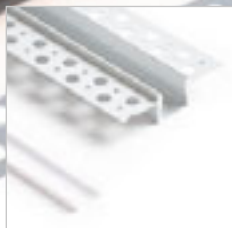

## LED PROFIL

Profilo in alluminio da utilizzare con striscia LED adatta. Fornito con diffusore opaco e accessori corrispondenti. Adatto solo per incasso in cartongesso.

### LED PROFILE B DA INCASSO 1M

R13865 alluminio/acrilico

€ 48

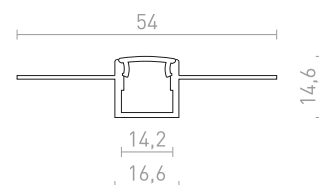

↑ 14  
 1000x17



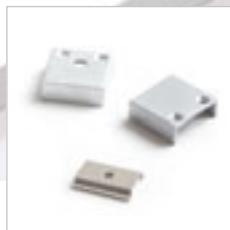

## LED PROFIL

Profilo in alluminio da utilizzare con striscia LED adatta. Fornito con diffusore opaco ed accessori.

**LED PROFILE D 1M AGGIUNTO**

**R13866** alluminio/acrilico

**€ 32**

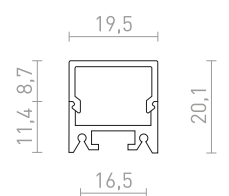





## PARALUMI ED ACCESSORI

|                                       |         |
|---------------------------------------|---------|
| PARALUMI A SOSPENSIONE                | 572-573 |
| PARALUMI LAMPADE DA TAVOLO / DA TERRA | 574-577 |
| PARALUMI UNIVERSALI                   | 578-593 |
| SET DA SOSPENSIONE                    | 594-607 |
| PIEDISTALLI / BASI                    | 608-617 |
| CAVI                                  | 618-619 |





PARALUMI ED ACCESSORI  
**PARALUMI  
 A SOSPENSIONE**



**ASPRO 40/30**  
572-573



**ASPRO 55/30**  
572-573



**DAISY**  
572-573

572-573



**BEAT 38**  
572-573

PARALUMI ED ACCESSORI  
**PARALUMI LAMPADE DA  
 TAVOLO / DA TERRA**



**CONNYP 15/15**  
574-575



**CONNYP 15/30**  
574-575

574-577



**CONNYP 25/30**  
574-575



**CONNYP 35/30**  
574-575



**ALVIS 24/15**  
576-577



**AMBITUS 30/21**  
576-577



**AMBITUS 46/24**  
576-577



**NIZZA 18/15**  
576-577

PARALUMI ED ACCESSORI  
**PARALUMI UNIVERSALI**



**RIDICK**  
578-579



**ILLUSION 45/33**  
578-579

578-593



**JAKARANDA 40**  
578-579



**DELISA 25/16**  
580-581



**DELISA 35/30**  
580-581



**RON 60/19**  
582-583



**RON 55/30**  
582-583



**RON 15/20**  
584-585



**RON 40/25**  
584-585



**DOUBLE 40/30**  
586-587



**DOUBLE 55/30**  
586-587



**TEMPO 30/19**  
588-589



**TEMPO 50/19**  
588-589



**TEMPO 15/15**  
590-591



**TEMPO 15/30**  
590-591



**CASUAL 90/22**  
590-591



**CASUAL 120/25**  
590-591



**LOPE 80/23**  
592-593



**LOPE 120/22**  
592-593

## PARALUMI ED ACCESSORI SET DA SOSPENSIONE



**MORE 60**  
594-595

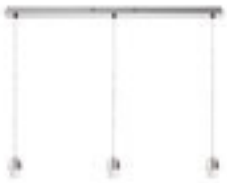

**MORE 80**  
594-595



**RALLONG IV**  
594-595



**RALLONG IV**  
594-595



**RALLONG V**  
594-595



**RALLONG V**  
594-595



**KOMBIX 2**  
596-597



**KOMBIX 3**  
596-597

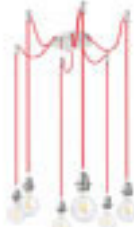

**KOMBIX 6**  
596-597



**HEX**  
598-599



**ELISA**  
600-601



**FABIO**  
602-603



**LISA**  
602-603



**ENZO**  
602-603



**SOLO SQ**  
604-605



**SOLO R**  
604-605



**POSTE**  
604-605



**TRIK**  
604-605



**SPIDER I**  
606-607

## PARALUMI ED ACCESSORI PIEDISTALLI / BASI

608-617



**BEND**  
608-609



**HUDSON**  
608-609



**WOODY**  
610-611



**NIZZA 18/15**  
610-611



**NIZZA**  
610-611



**AMBITUS**  
612-613



**AMBITUS**  
612-613



**ALVIS**  
612-613



**ALVIS**  
612-613



**KEITH**  
614-615



**MAUI**  
614-615



**LUTON**  
614-615



**NYC TRIPOD**  
614-615



**NYC**  
616-617



**NYC**  
616-617



**CORTINA**  
616-617



**CORTINA**  
616-617

## PARALUMI ED ACCESSORI CAVI

618-619



**FIT 3x0,75 4m**  
618-619



**FIT 3x0,75**  
618-619



**FIT 3x0,75**  
618-619

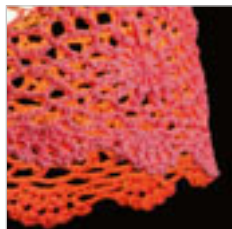

## DAISY

Paralume in decoro all'uncinetto. Accessori adatti: ELISA, ENZO, HEX, LISA.

### DAISY PARALUME A SOSPENSIONE

max. 15 W

R13278 rosa

€ 29 %

R13279 bianco/grigio chiaro

€ 29 %



## BEAT

Paralume robusto trapuntato in similpelle nera.

### BEAT 38 PARALUME A SOSPENSIONE

max. 28 W

R13281 nero

€ 48 %

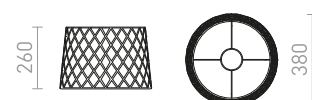





## ASPRO

Paralume in tessuto con portalampada E27. Adatto per installazione su set da sospensione. Un diffusore PMMA (R11868, R12300) può essere ordinato per il paralume. Adatto per accessori: HEX, ELISA, ENZO, KOMBIX, LISA, POSTE, TRIX.

### ASPRO 55/30 PARALUME

max 23 W

|  |   |       |
|--|---|-------|
|  | <b>R11466</b><br>policotone nero/lamina d'oro   | € 248 |
|  | <b>R11482</b><br>policotone nero/lamina di rame | € 248 |
|  | <b>R11494</b><br>policotone bianco/PVC bianco   | € 120 |
|  | <b>R11577</b><br>Monaco benzina/PVC argento     | € 229 |
|  | <b>R11588</b><br>grigio piccione/PVC argento    | € 229 |

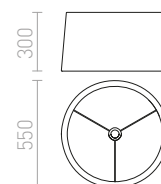

## ASPRO

Paralume in tessuto con portalampada E27. Adatto per installazione su set da sospensione. Il diffusore PMMA (R11867) può essere ordinato per il paralume. Combinabile con: HEX, ELISA, ENZO, KOMBIX, LISA, POSTE, TRIX.

### ASPRO 40/30 PARALUME

max 23 W

|  |   |       |
|--|---|-------|
|  | <b>R11467</b><br>policotone nero/lamina d'oro   | € 178 |
|  | <b>R11483</b><br>policotone nero/lamina di rame | € 178 |
|  | <b>R11495</b><br>policotone bianco/PVC bianco   | € 120 |
|  | <b>R11578</b><br>Monaco benzina/PVC argento     | € 188 |
|  | <b>R11589</b><br>grigio piccione/PVC argento    | € 188 |

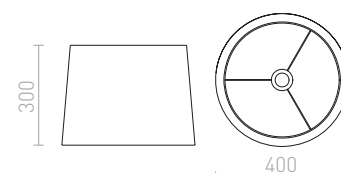



## CONNY

Paralume in tessuto per portalampana E27. Installazione su piedistallo da tavolo. Accessori adatti: CORTINA, NYC, TREPPIEDI DI NYC, WOODY.

### CONNY 25/30 PARALUME / LAMPADE DA TAVOLO max. 23 W

|  |   |       |
|--|---|-------|
|  | <b>R11371</b><br>policotone nero/lamina di rame | € 129 |
|  | <b>R11497</b><br>policotone bianco/PVC bianco   | € 68  |
|  | <b>R11580</b><br>Monaco benzina/PVC argento     | € 120 |
|  | <b>R11591</b><br>grigio piccione/PVC argento    | € 120 |
|  | <b>R11597</b><br>policotone nero/lamina d'oro   | € 129 |

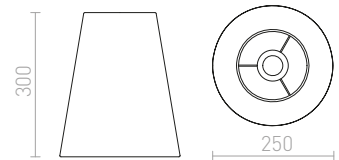

## CONNY

Paralume in tessuto per portalampana E27. Installazione su piedistallo a stelo. Accessori adatti: ALVIS, AMBITUS, CORTINA, NYC, TREPPIEDI DI NYC, WOODY.

### CONNY 35/30 PARALUME / LAMPADE DA TERRA max. 23 W

|  |   |       |
|--|---|-------|
|  | <b>R11372</b><br>policotone nero/lamina di rame | € 178 |
|  | <b>R11469</b><br>policotone nero/lamina d'oro   | € 178 |
|  | <b>R11498</b><br>policotone bianco/PVC bianco   | € 88  |
|  | <b>R11581</b><br>Monaco benzina/PVC argento     | € 178 |
|  | <b>R11592</b><br>grigio piccione/PVC argento    | € 178 |

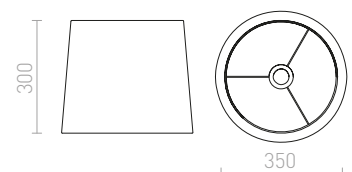



## CONNYP

Paralume in tessuto per portalamпада E27. Installazione su piedistallo da tavolo. Accessori adatti: ALVIS, AMBITUS, CORTINA, NYC.

### CONNYP 15/15 PARALUME

max 28 W

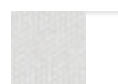

**R11800**  
policotone bianco/PVC bianco

€ 68

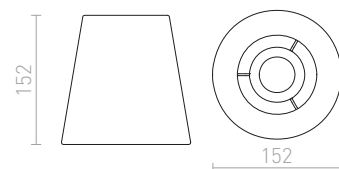

## CONNYP

Paralume in tessuto per portalamпада E27. Installazione su piedistallo da tavolo. Accessori adatti: CORTINA, NYC.

### CONNYP 15/30 PARALUME / LAMPADE DA TAVOLO

max 23 W



**R11370**  
policotone nero/lamina di rame

€ 88



**R11468**  
policotone nero/lamina d'oro

€ 98

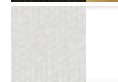

**R11496**  
policotone bianco/PVC bianco

€ 68



**R11579**  
Monaco benzina/PVC argento

€ 98



**R11590**  
grigio piccione/PVC argento

€ 98

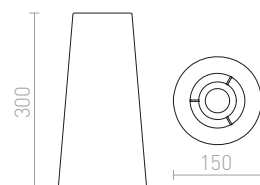



## AMBITUS

Paralume in tessuto con portalampada E27.  
Installazione su piedistallo da tavolo. Accessori adatti:  
ALVIS, AMBITUS, CORTINA, MAUI, NYC, WOODY.

### AMBITUS 30/21 PARALUME / LAMPADE DA TAVOLO

max. 28 W

R13841 policotone bianco

€ 68 **NEW**

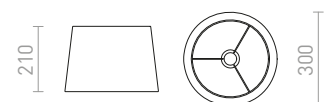



## NIZZA

Paralume in tessuto adatto per portalampada E27, adatto per installazione su set da sospensione e lampada da tavolo R12947.

### NIZZA 18/15 PARALUME

max 28 W

**R13113** policotone bianco/PVC bianco

€ 58

**R13114** policotone nero/PVC bianco

€ 58

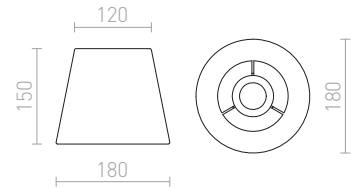

## ALVIS

Paralume in tessuto adatto con portalampada E27. Adatto per piedistallo da tavolo: ALVIS, CORTINA, MAUI, NYC, WOODY.

### ALVIS 24/15 PARALUME / LAMPADE DA TAVOLO

max 28 W

**R13524** bianco crema

€ 48

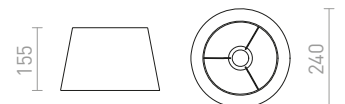

## AMBITUS

Paralume in tessuto con portalampada E27. Installazione su piedistallo da tavolo. Accessori adatti: ALVIS, AMBITUS, CORTINA, NYC, NYC TRIPOD.

### AMBITUS 46/24 PARALUME / LAMPADE DA TERRA

max 28 W

**R13526** bianco crema

€ 98

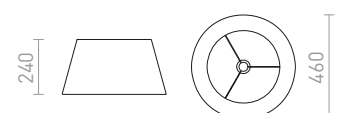





## RIDICK

Paralume decorativo nero con interno dorato, che può essere combinato con un set da sospensione o per piedistallo da terra. Accessori adatti: HEX, ELISA, ENZO, LISA, KOMBIX, BEND, ALVIS, AMBITUS, NYC.

### RIDICK PARALUME

max. 20 W

**R13344** nero lucido/lamina d'oro

€ 68 →

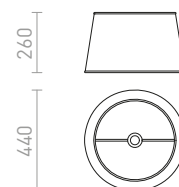

## ILLUSION

Paralume decorativo in lamina cromata, può essere combinato con un set da sospensione o una base per lampada da terra. A luce spenta dà effetto speculare, a luce accesa sono parzialmente visibili le sorgenti luminose. Accessori adatti: HEX, ELISA, ENZO, LISA, KOMBIX, BEND, ALVIS, AMBITUS, NYC.

### ILLUSION 45/33 PARALUME

max. 20 W

**R13417** pellicola cromata

€ 98 →

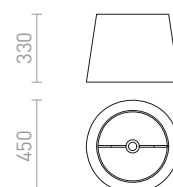

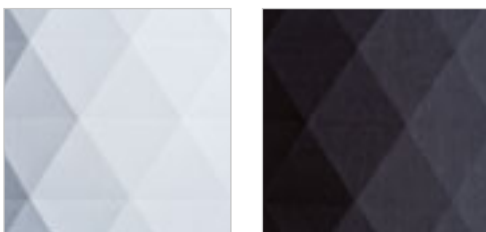

## JAKARANDA

Paralume in tessuto con superficie 3D geometrica. Da utilizzare con set da sospensione o per piedistallo con portalamпада E27. Accessori adatti: HEX, ELISA, ENZO, KOMBIX, LISA, AMBITUS, ALVIS, CORTINA.

### JAKARANDA 40 PARALUME

max 28 W

R12392 bianco

€ 120

R12393 nero

€ 120

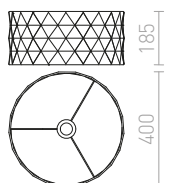



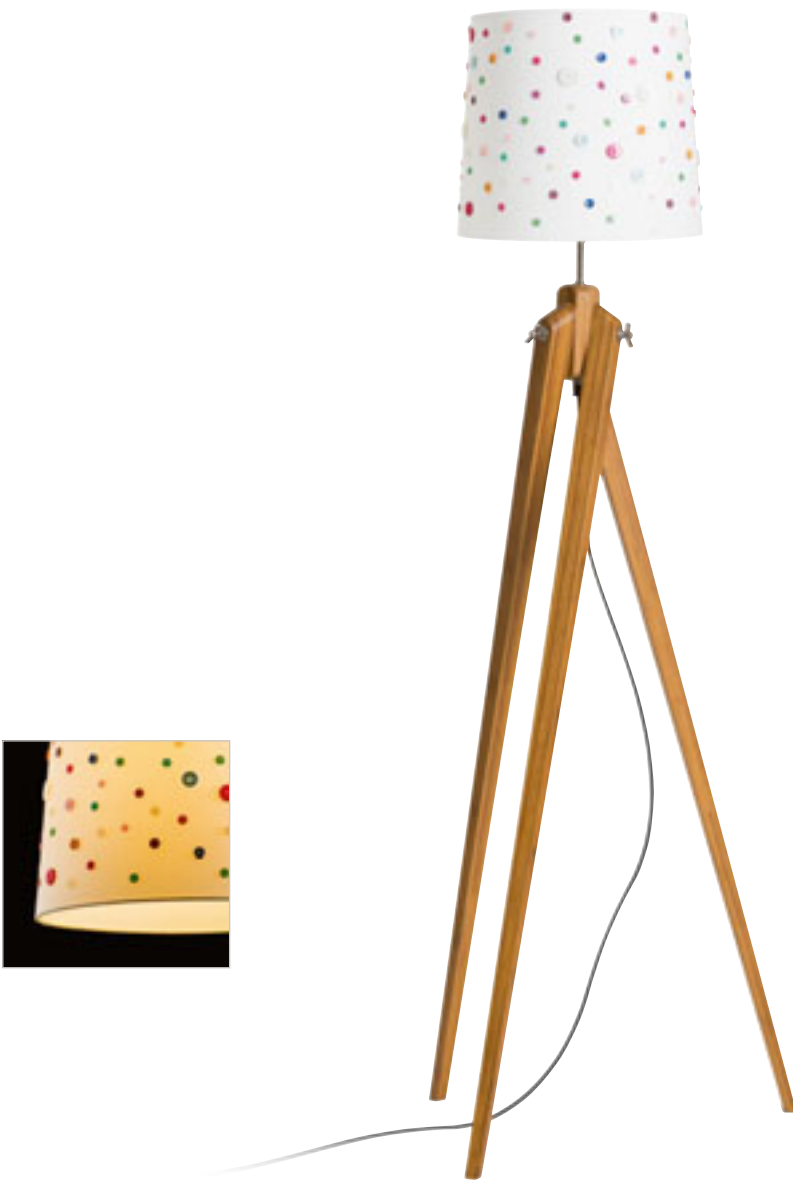

## DELISA

Paralume decorativo con bottoni multicolore, adatto per luci a sospensione o per piedistallo da terra. Accessori adatti: HEX, ELISA, ENZO, LISA, KOMBIX, AMBITUS, ALVIS, CORTINA.

### DELISA 35/30 PARALUME

max 28 W

R12389 bianco/bottoni

€ 78

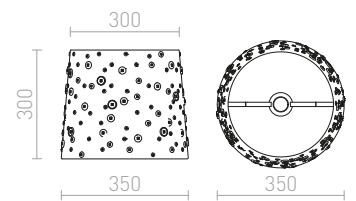

## DELISA

Paralume decorativo con bottoni multicolore, adatto per luci a sospensione o per piedistallo da tavolo. Accessori adatti: HEX, ELISA, ENZO, KOMBIX, LISA, AMBITUS, ALVIS, CORTINA.

### DELISA 25/16 PARALUME

max 28 W

R12388 bianco/bottoni

€ 35

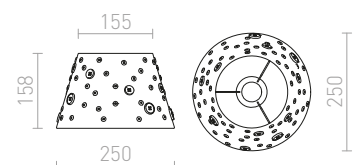





## DIFFUSER

Diffusore circolare per paralumi in tessuto.

### DIFFUSER R 60 PMMA

G11869 acrilico

€ 32

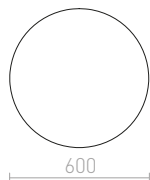

## RON

Paralume in tessuto adatto per portalampana E27 da installare a base per soffitto o con set da sospensione. Il diffusore PMMA (R11869, R12301) può essere ordinato per il paralume. Il diffusore non è adatto per R11452. Accessori adatti: HEX, ELISA, ENZO, LISA, POSTE, TRIX.

### RON 60/19 PARALUME

max. 23 W

|  |  |       |
|--|--|-------|
|  | <b>R11462</b><br>policotone nero/lamina d'oro    | € 178 |
|  | <b>R11479</b><br>policotone nero/lamina di rame  | € 178 |
|  | <b>R11490</b><br>policotone bianco/PVC bianco    | € 120 |
|  | <b>R11517</b><br>Chintz arancione/PVC bianco     | € 98  |
|  | <b>R11546</b><br>Chintz menta/lamina d'argento   | € 188 |
|  | <b>R11555</b><br>Chintz grigio chiaro/PVC bianco | € 98  |
|  | <b>R11565</b><br>Chintz limetta/PVC bianco       | € 98  |
|  | <b>R11573</b><br>Monaco benzina/PVC argento      | € 188 |
|  | <b>R11584</b><br>grigio piccione/PVC argento     | € 188 |
|  | <b>R11607</b><br>Chintz albicocca/PVC bianco     | € 98  |
|  | <b>R13052</b><br>policotone nero/PVC bianco      | € 120 |

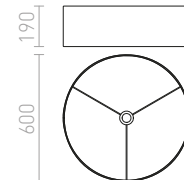





## DIFFUSER

Diffusore circolare per paralumi in tessuto.

### DIFFUSER R 55 PMMA

**G11868** acrilico

€ 29

**G12300** chiaro

€ 32



## RON

Paralume in tessuto per portalamпада E27. Adatto per installazione su base per soffitto, set da sospensione o per piedistallo da terra. Accessori adatti: HEX, ELISA, ENZO, LISA, POSTE, TRIX, KOMBIX. Diffusore PMMA (R11868, R12300) ordinabile per il paralume.

### RON 55/30 PARALUME

max. 23 W

|  |  |       |
|--|--|-------|
|  | <b>R11463</b><br>policotone nero/lamina d'oro    | € 220 |
|  | <b>R11480</b><br>policotone nero/lamina di rame  | € 220 |
|  | <b>R11491</b><br>policotone bianco/PVC bianco    | € 120 |
|  | <b>R11518</b><br>Chintz arancione/PVC bianco     | € 98  |
|  | <b>R11556</b><br>Chintz grigio chiaro/PVC bianco | € 98  |
|  | <b>R11566</b><br>Chintz limetta/PVC bianco       | € 98  |
|  | <b>R11574</b><br>Monaco benzina/PVC argento      | € 188 |
|  | <b>R11585</b><br>grigio piccione/PVC argento     | € 188 |
|  | <b>R11608</b><br>Chintz albicocca/PVC bianco     | € 98  |
|  | <b>R13051</b><br>policotone nero/PVC bianco      | € 120 |

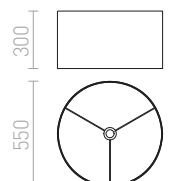



## DIFFUSER

Diffusore circolare per paralumi in tessuto.

### DIFFUSER R 40 PMMA

**G11867** acrilico

€ 17.50

**G12299** chiaro

€ 19.50



## RON

Paralume in tessuto per portalampada E27. Adatto per installazione su base per soffitto, set da sospensione o per piedistallo da terra. Il diffusore PMMA (R11867, R12299) può essere ordinato per il paralume separatamente, e non è adatto per R11389 e R11455. Accessori adatti: SOLO, HEX, ELISA, ENZO, LISA, KOMBIX, AMBITUS, ALVIS, CORTINA, NYC, NYC TRIPOD, WOODY.

### RON 40/25 PARALUME

max 23 W

|  |  |       |
|--|--|-------|
|  | <b>R11465</b><br>policotone nero/lamina d'oro    | € 138 |
|  | <b>R11481</b><br>policotone nero/lamina di rame  | € 138 |
|  | <b>R11493</b><br>policotone bianco/PVC bianco    | € 88  |
|  | <b>R11510</b><br>Chintz albicocca/PVC bianco     | € 78  |
|  | <b>R11520</b><br>Chintz arancione/PVC bianco     | € 78  |
|  | <b>R11549</b><br>Chintz menta/lamina d'argento   | € 138 |
|  | <b>R11558</b><br>Chintz grigio chiaro/PVC bianco | € 78  |
|  | <b>R11568</b><br>Chintz limetta/PVC bianco       | € 78  |
|  | <b>R11576</b><br>Monaco benzina/PVC argento      | € 138 |
|  | <b>R11587</b><br>grigio piccione/PVC argento     | € 138 |
|  | <b>R13050</b><br>policotone nero/PVC bianco      | € 88  |

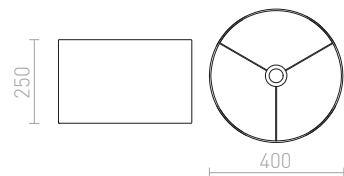



## RON

Paralume in tessuto con portalampada E27, adatto per installazione su set da sospensione o piedistalli da tavolo. Accessori adatti: HEX, ELISA, ENZO, KOMBIX, LISA, MORE, CORTINA, NYC.

### RON 15/20 PARALUME

max. 28 W

|  |   |      |
|--|---|------|
|  | <b>R11802</b><br>policotone nero/lamina d'oro   | € 98 |
|  | <b>R11803</b><br>policotone nero/lamina di rame | € 98 |
|  | <b>R11804</b><br>policotone bianco/PVC bianco   | € 68 |
|  | <b>R11805</b><br>Chintz albicocca/PVC bianco    | € 68 |
|  | <b>R11806</b><br>Chintz arancione/PVC bianco    | € 68 |
|  | <b>R11809</b><br>Chintz limetta/PVC bianco      | € 68 |
|  | <b>R11810</b><br>grigio piccione/PVC argento    | € 88 |
|  | <b>R11811</b><br>Monaco benzina/PVC argento     | € 88 |
|  | <b>R13049</b><br>policotone nero/PVC bianco     | € 68 |

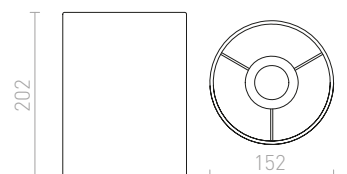



## DIFFUSER

Diffusore circolare per paralumi in tessuto.

### DIFFUSER R 55 PMMA

**G11868** acrilico

€ 29

**G12300** chiaro

€ 32



## DOUBLE

Paralume in tessuto per portalampada E27. Installazione a base per soffitto o set da sospensione. Diffusore PMMA (R11868, R12300) può essere ordinato per il paralume separatamente. Accessori adatti: HEX, ELISA, ENZO, KOMBIX, LISA, POSTE, TRIX.

### DOUBLE 55/30 PARALUME

max. 23 W

|  |  |       |
|--|--|-------|
|  | <b>R11477</b><br>policotone nero/lamina d'oro    | € 215 |
|  | <b>R11478</b><br>policotone nero/lamina di rame  | € 215 |
|  | <b>R11508</b><br>Chintz albicocca/PVC bianco     | € 120 |
|  | <b>R11516</b><br>Chintz arancione/PVC bianco     | € 120 |
|  | <b>R11545</b><br>Chintz menta/lamina d'argento   | € 215 |
|  | <b>R11554</b><br>Chintz grigio chiaro/PVC bianco | € 120 |
|  | <b>R11564</b><br>Chintz limetta/PVC bianco       | € 120 |
|  | <b>R11600</b><br>policotone bianco/PVC bianco    | € 138 |

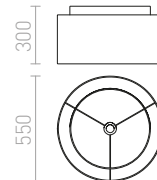



## DIFFUSER

Diffusore circolare per paralumi in tessuto.

### DIFFUSER R 40 PMMA

G11867 acrilico

€ 17.50

G12299 chiaro

€ 19.50



## DOUBLE

Paralume in tessuto per portalamпада E27. Installazione a base per soffitto o set da sospensione. Diffusore PMMA (R11867, R12299) può essere ordinato per il paralume separatamente. Accessori adatti: HEX, ELISA, ENZO, KOMBIX, LISA.

### DOUBLE 40/30 PARALUME

max 23 W

|  |  |         |
|--|--|---------|
|  | <b>R11461</b><br>policotone nero/lamina d'oro    | € 178   |
|  | <b>R11507</b><br>Chintz albicocca/PVC bianco     | € 120   |
|  | <b>R11515</b><br>Chintz arancione/PVC bianco     | € 120   |
|  | <b>R11535</b><br>Chintz oliva/lamina d'argento   | € 120 % |
|  | <b>R11544</b><br>Chintz menta/lamina d'argento   | € 215   |
|  | <b>R11553</b><br>Chintz grigio chiaro/PVC bianco | € 120   |
|  | <b>R11563</b><br>Chintz limetta/PVC bianco       | € 120   |
|  | <b>R11599</b><br>policotone bianco/PVC bianco    | € 129   |

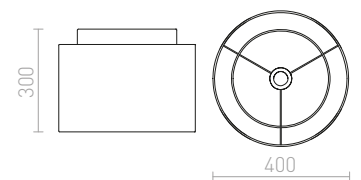





## DIFFUSER

Diffusore quadrato per paralumi di tessuto.

### DIFFUSER SQ 50 PMMA

G11871 acrilico

€ 32

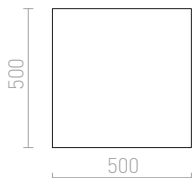

## TEMPO

Paralume in tessuto per portalamпада E27, da installare su base per soffitto o set da sospensione. Diffusore PMMA (R11871) può essere ordinato per paralume separatamente. Accessori adatti: HEX, ELISA, ENZO, KOMBIX, LISA, NYC.

### TEMPO 50/19 PARALUME

max. 23 W

|  |  |        |
|--|--|--------|
|  | <b>R11475</b><br>policotone nero/lamina d'oro    | € 178  |
|  | <b>R11488</b><br>policotone nero/lamina di rame  | € 178  |
|  | <b>R11505</b><br>policotone bianco/PVC bianco    | € 98   |
|  | <b>R11513</b><br>Chintz albicocca/PVC bianco     | € 48 % |
|  | <b>R11523</b><br>Chintz arancione/PVC bianco     | € 48 % |
|  | <b>R11542</b><br>Chintz oliva/lamina d'argento   | € 48 % |
|  | <b>R11551</b><br>Chintz menta/lamina d'argento   | € 48 % |
|  | <b>R11561</b><br>Chintz grigio chiaro/PVC bianco | € 78   |

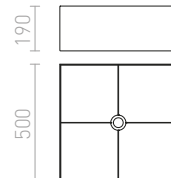



## DIFFUSER

Diffusore quadrato per paralumi di tessuto.

### DIFFUSER SQ 30 PMMA

G11870 acrilico

€ 18

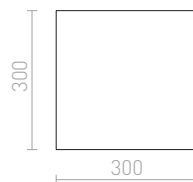

## TEMPO

Paralume in tessuto per portalampana E27, adatto per installazione su base per soffitto, set da sospensione o per piedistallo da tavolo. Un diffusore PMMA (R11870) può essere ordinato per paralume separatamente. Accessori adatti: SOLO, HEX, ELISA, ENZO, KOMBIX, LISA, NYC.

### TEMPO 30/19 PARALUME

max 23 W

|  |  |        |
|--|--|--------|
|  | <b>R11476</b><br>policotone nero/lamina d'oro    | € 129  |
|  | <b>R11489</b><br>policotone nero/lamina di rame  | € 129  |
|  | <b>R11506</b><br>policotone bianco/PVC bianco    | € 78   |
|  | <b>R11514</b><br>Chintz albicocca/PVC bianco     | € 48 % |
|  | <b>R11524</b><br>Chintz arancione/PVC bianco     | € 48 % |
|  | <b>R11543</b><br>Chintz oliva/lamina d'argento   | € 48 % |
|  | <b>R11552</b><br>Chintz menta/lamina d'argento   | € 48 % |
|  | <b>R11562</b><br>Chintz grigio chiaro/PVC bianco | € 38 % |

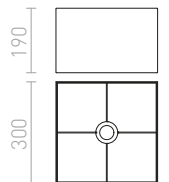



## TEMPO

Paralume in tessuto per portalampana E27. Adatto per installazione su set da sospensione o piedistalli da tavolo. Accessori adatti: HEX, ELISA, ENZO, KOMBIX, LISA, MORE, NYC.

### TEMPO 15/30 PARALUME

max 28 W

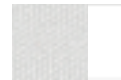

**R11822**

policotone bianco/PVC bianco

€ 78

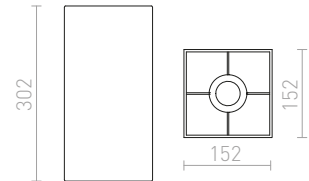

## TEMPO

Paralume in tessuto per portalampana E27. Adatto per installazione su set da sospensione o per piedistallo da tavolo. Accessori adatti: HEX, ELISA, ENZO, KOMBIX, LISA, MORE, NYC.

### TEMPO 15/15 PARALUME

max 28 W



**R11812**

policotone nero/lamina d'oro

€ 88



**R11813**

policotone nero/lamina di rame

€ 88



**R11814**

policotone bianco/PVC bianco

€ 58

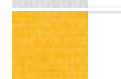

**R11815**

Chintz albicocca/PVC bianco

€ 58



**R11816**

Chintz arancione/PVC bianco

€ 58



**R11817**

Chintz terracotta/PVC bianco

€ 29

%

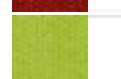

**R11819**

Chintz limetta/PVC bianco

€ 58



**R11820**

Monaco benzina/PVC argento

€ 88

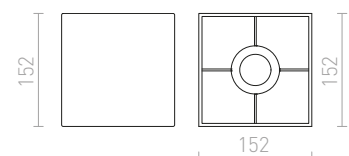



## CASUAL

Paralume di tessuto per installazione su base per soffitto R11797 o su set da sospensione R11798.

### CASUAL 120/25 PARALUME

max 23 W

|  |   |              |
|--|---|--------------|
|  | <b>R11471</b><br>policotone nero/lamina d'oro   | <b>€ 329</b> |
|  | <b>R11484</b><br>policotone nero/lamina di rame | <b>€ 329</b> |
|  | <b>R11500</b><br>policotone bianco/PVC bianco   | <b>€ 178</b> |
|  | <b>R11582</b><br>Monaco benzina/PVC argento     | <b>€ 278</b> |
|  | <b>R11593</b><br>grigio piccione/PVC argento    | <b>€ 278</b> |

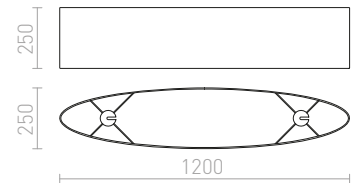

## CASUAL

Paralume in tessuto per installazione su base per soffitto R11795 o su set da sospensione R11796.

### CASUAL 90/22 PARALUME

max 23 W

|  |   |              |
|--|---|--------------|
|  | <b>R11472</b><br>policotone nero/lamina d'oro   | <b>€ 248</b> |
|  | <b>R11485</b><br>policotone nero/lamina di rame | <b>€ 248</b> |
|  | <b>R11501</b><br>policotone bianco/PVC bianco   | <b>€ 178</b> |
|  | <b>R11583</b><br>Monaco benzina/PVC argento     | <b>€ 215</b> |
|  | <b>R11594</b><br>grigio piccione/PVC argento    | <b>€ 215</b> |

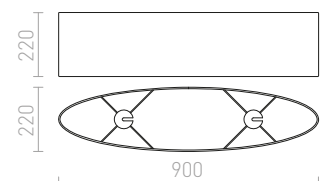



## LOPE

Paralume in tessuto adatto per installazione a base per soffitto R11797 o su set da sospensione R11798.

### LOPE 120/22 PARALUME

max 23 W

|  |  |        |
|--|--|--------|
|  | <b>R11473</b><br>policotone nero/lamina d'oro    | € 320  |
|  | <b>R11486</b><br>policotone nero/lamina di rame  | € 320  |
|  | <b>R11502</b><br>policotone bianco/PVC bianco    | € 178  |
|  | <b>R11611</b><br>Chintz albicocca/PVC bianco     | € 88 % |
|  | <b>R11616</b><br>Chintz arancione/PVC bianco     | € 88 % |
|  | <b>R11634</b><br>Chintz grigio chiaro/PVC bianco | € 88 % |
|  | <b>R11639</b><br>Chintz limetta/PVC bianco       | € 88 % |

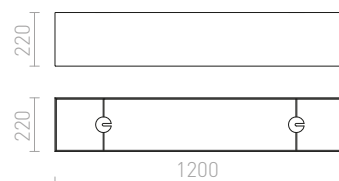





## LOPE

Paralume in tessuto adatto per installazione a base per soffitto R11795 o su set da sospensione R11796.

### LOPE 80/23 PARALUME

max 23 W

|  |  |        |
|--|--|--------|
|  | <b>R11474</b><br>policotone nero/lamina d'oro    | € 178  |
|  | <b>R11487</b><br>policotone nero/lamina di rame  | € 88 % |
|  | <b>R11503</b><br>policotone bianco/PVC bianco    | € 138  |
|  | <b>R11511</b><br>Chintz albicocca/PVC bianco     | € 35 % |
|  | <b>R11541</b><br>Chintz oliva/lamina d'argento   | € 88 % |
|  | <b>R11550</b><br>Chintz menta/lamina d'argento   | € 88 % |
|  | <b>R11559</b><br>Chintz grigio chiaro/PVC bianco | € 48 % |
|  | <b>R11569</b><br>Chintz limetta/PVC bianco       | € 35 % |

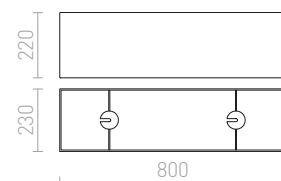



**MORE**

Base lineare da soffitto in finitura lucida e opaca, in lunghezza di 60 o 80 cm, per tre paralumi sospesi. Adatto per paralumi: RON, 15/20, TEMPO 15/15, TEMPO 15/30.

**MORE 80 BASE A SOSPENSIONE DA SOFFITTO**

230 V E27 3x42 W

- R11776 nichel opaco € 58 %
- R11777 cromo € 58 %

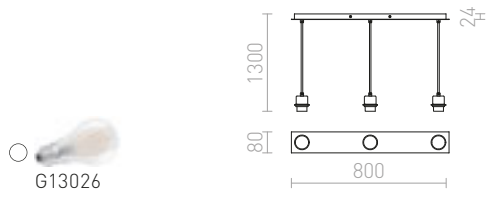

**MORE 60 BASE A SOSPENSIONE DA SOFFITTO**

230 V E27 3x42 W

- R11774 nichel opaco € 48 %
- R11775 cromo € 48 %

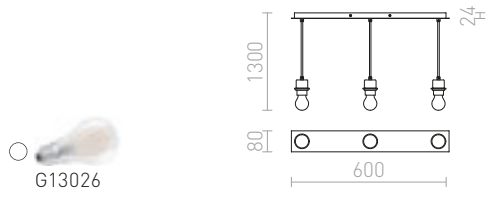



## RALLONG

Basi a sospensione / per soffitto per paralumi longitudinali in tessuto. RALLONG 4 si abbina con paralumi CASUAL 90 e LOPE 80. RALLONG 5 con paralumi CASUAL 120 e LOPE 120.

### RALLONG IV BASE A SOSPENSIONE

230 V E27 4x42 W

R11796 cromo

€ 68

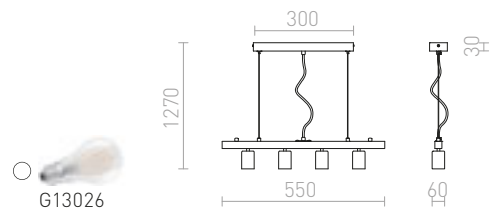

### RALLONG V BASE A SOSPENSIONE

230 V E27 5x42 W

R11798 cromo

€ 68

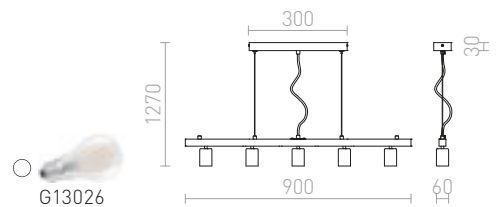

### RALLONG IV BASE PER SOFFITTO

230 V E27 4x42 W

R11795 cromo

€ 32

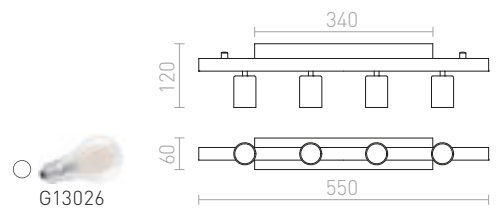

### RALLONG V BASE PER SOFFITTO

230 V E27 5x42 W

R11797 cromo

€ 48

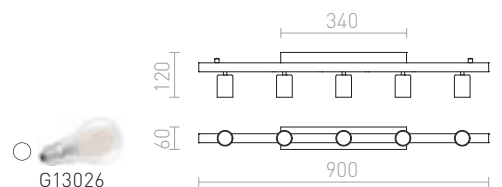

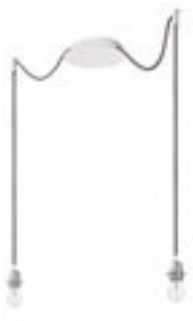

R11778  
€ 178

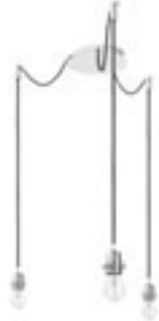

R11779  
€ 229



R11780  
€ 380



R11781  
€ 158



R11782  
€ 215



R11783  
€ 335



R11787  
€ 150



R11788  
€ 215



R11789  
€ 335

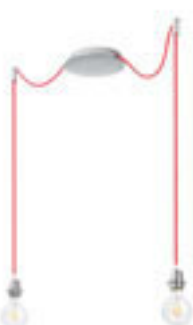

R11784  
€ 158



R11785  
€ 215



R11786  
€ 398



R11778 + R11563



R11783 + R11810



## KOMBIX

Apparecchio a sospensione con base centrale per soffitto e singoli cavi di tessuto con portalampade metalliche E27, per uso con lampadine decorative o paralumi di tessuto adatti. I cavi di sospensione sono dotati di agganci da soffitto cromati, posizionabili ad una distanza individuale dalla base. La lunghezza totale di ciascun cavo è di 3 m.

### KOMBIX 2 SET DA SOSPENSIONE

230 V E27 2x28 W

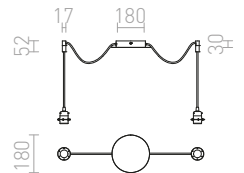

### KOMBIX 3 SET DA SOSPENSIONE

230 V E27 3x28 W

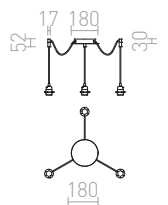

### KOMBIX 6 SET DA SOSPENSIONE

230 V E27 6x28 W

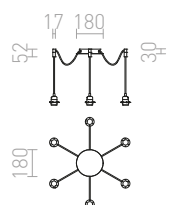





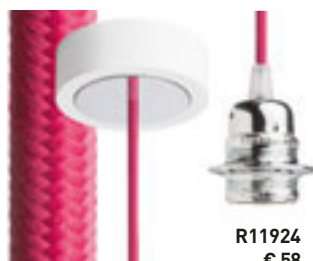
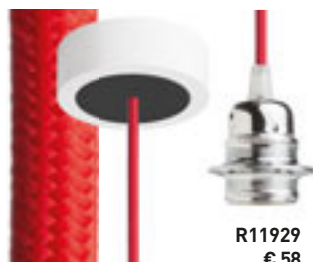

## HEX

Set da sospensione con base decorativa in metallo con portalampada E27 e cavo in tessuto. Adatto per uso indipendente o con paralumi a sospensione leggeri. Adatto per paralumi: DOUBLE 40/30, DOUBLE 55/30, ASPRO 40/30, ASPRO 55/30, KARO 55/15, KARO 80/20, RON 40/25, RON 55/30, RON 60/19, TEMPO 30/19, TEMPO 50/19.

### HEX SET DA SOSPENSIONE

230 V E27 28 W

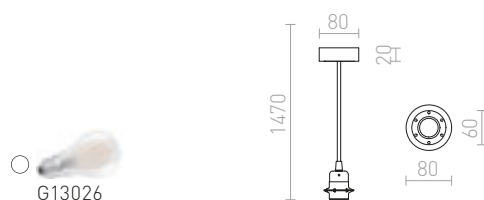



R11879  
€ 48



R11886  
€ 48



R11880  
€ 48



R11892  
€ 48



R11884  
€ 48



R11888  
€ 48



R11877  
€ 48



R11891  
€ 48



R11875  
€ 48



R11896  
€ 48



R11876  
€ 48



R11894  
€ 48



R11906  
€ 48





R11885  
€ 48



R11883  
€ 48



R11882  
€ 48



R11881  
€ 48

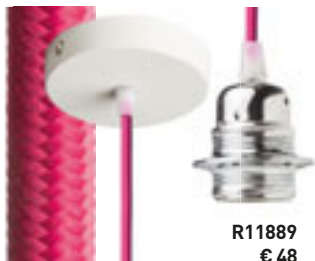

R11889  
€ 48



R11872  
€ 48



R11887  
€ 48



R11890  
€ 48



R11874  
€ 48



R11873  
€ 48



R11878  
€ 48



R11908  
€ 48



R11897  
€ 48



R11895  
€ 48



R11893  
€ 48



R11898  
€ 48



R11905  
€ 48



R11904  
€ 48



R11903  
€ 58



R11907  
€ 48



R11900  
€ 48



R11902  
€ 58



R11901  
€ 58



R11899  
€ 48

## ELISA

Set da sospensione con base circolare in metallo, cavo in tessuto e portalampana in metallo E27. Adatto per uso indipendente o con paralumi a sospensione leggeri. Adatto per paralumi: DOUBLE 40/30, DOUBLE 55/30, ASPRO 40/30, ASPRO 55/30, KARO 55/15, KARO 80/20, KARO 80/30, RON 40/25, RON 55/30, RON 60/19, TEMPO 30/19, TEMPO 50/19.

### ELISA SET DA SOSPENSIONE

230 V E27 28 W

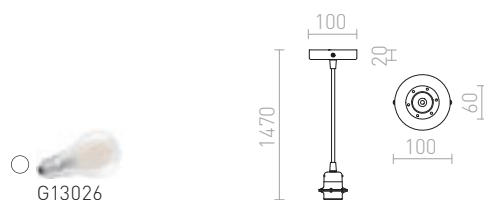



## FABIO

Set da sospensione elegante con copertura per soffitto di porcellana e portalampada E27 su cavo di tessuto. Adatto solo per uso indipendente con lampadina decorativa. Dimensioni del portalampada in ceramica 6x4,5 cm (ØxAl).

### FABIO SET DA SOSPENSIONE

230 V E27 42 W

**R10617** nero/bianco/porcellana

€ 32 %

**R10618** nero/porcellana

€ 32 %



G12246

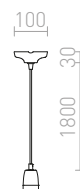





## LISA

Set da sospensione con cavo in tessuto, copertura in silicone di portalampada E27 e tappo in plastica per soffitto. Adatto per: ARISTA, DELI, DELISA, JAKARANDA, DOUBLE 40/30, DOUBLE 55/30, ASPRO 40/30, ASPRO 55/30, KARO 55/15, KARO 80/20, RON 15/20, RON 40/25, RON 55/30, RON 60/19, TEMPO 15/15, TEMPO 15/30, TEMPO 30/19, TEMPO 50/19.

### LISA SERIE A SOSPENSIONE

230 V E27 42 W

|                      |         |   |
|----------------------|---------|---|
| <b>R10622</b> rosso  | € 18.50 | % |
| <b>R10623</b> verde  | € 9.35  | % |
| <b>R10624</b> bianco | € 24    |   |
| <b>R10625</b> nero   | € 24    |   |

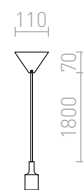

## ENZO

Set da sospensione con elementi cromati, cavo trasparente e portalampada E27. Adatto per: ARISTA, DELI, DELISA, JAKARANDA, DOUBLE 40/30, DOUBLE 55/30, ASPRO 40/30, ASPRO 55/30, ASPRO 55/30, KARO 55/15, KARO 80/20, RON 15/20, RON 40/25, RON 55/30, RON 60/19, TEMPO 15/15, TEMPO 15/30, TEMPO 30/19, TEMPO 50/19.

### ENZO SET DA SOSPENSIONE

230 V E27 42 W

|                     |      |
|---------------------|------|
| <b>R10616</b> cromo | € 28 |
|---------------------|------|

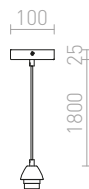
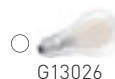



## SOLO

Base per soffitto per paralumi di tessuto con portalamпада E27. Adatta per paralumi: DELI 30/20, DOUBLE 40/30, JAKARANDA, RON 40/25, TEMPO 30/19.

### SOLO SQ BASE PER SOFFITTO

230 V E27 53 W

R12584 cromo

€ 28

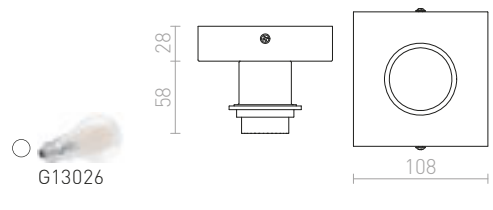

### SOLO R BASE PER SOFFITTO

230 V E27 53 W

R12583 cromo

€ 28

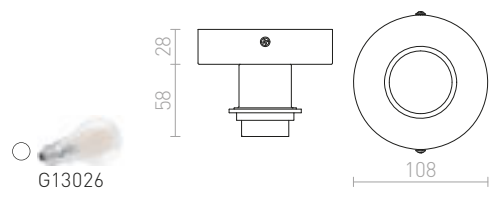

## POSTE

Base per soffitto cromata con tre portalamпада E27 regolabili. Adatto per paralumi in tessuto grandi più di 30 cm. Adatto per paralumi: DELI 55/30, DOUBLE 55/30, RON 55/30, RON 60/19, TEMPO 50/19.

### POSTE BASE PER SOFFITTO

230 V E27 3x20 W

R11799 cromo

€ 68

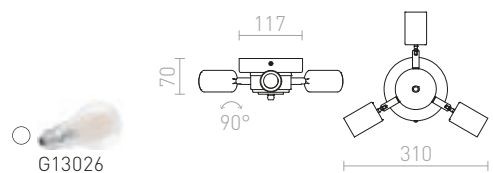



## TRIX

Set da sospensione con tre portalampade inclinabili in 90°. Adatte per apparecchi: DOUBLE 55/30, ASPRO 55/30, KARO 55/15, KARO 80/20, RON 55/30, RON 60/19, TEMPO 50/19.

### TRIX SET DA SOSPENSIONE

230 V E27 3x42 W

R10615 cromo

€ 98

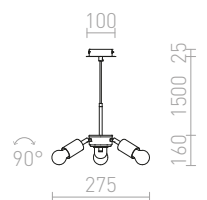



## SPIDER

Set variabile adatto per uso autonomo con una lampadina decorativa o con un paralume leggero. Il set può essere fissato al soffitto o a parete con agganci posti sul cavo tessile nero. Il set contiene 4 pezzi di agganci in plastica nera o 4 agganci in metallo cromati. Questi possono anche essere ordinati separatamente. Adatto con paralumi: ARISTA, ASPRO, DOUBLE, JAKARANDA, RON.

### SPIDER I SET DA SOSPENSIONE

230 V E27 15 W

**R13492** nero

€ 58

**R13493** nero/cromo

€ 78

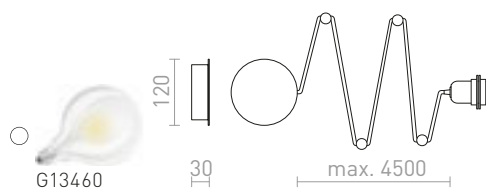



## SPIDER

Agganci di ricambio per set cavi SPIDER R13492 e R13493.

### SPIDER CONNETTORE / MANIGLIA

R13494 nero/plastica

€ 2.20

R13495 cromo/metallo

€ 5.80

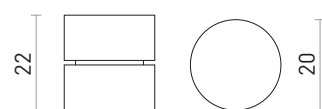







## HUDSON

Lampada da parete con base cromata e cavo verticale, rifinito con un paralume cilindrico di tessuto.

### HUDSON DA PARETE

230 V E27 28 W

R13284 bianco/cromo

€ 138

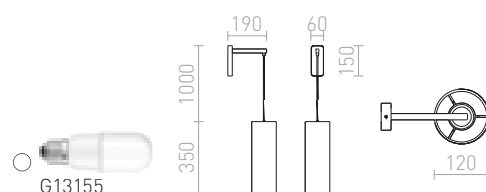

## BEND

Base da parete in nichel con cavo di alimentazione per presa. Adatto per paralumi in tessuto con portalampana E27. L'interruttore è posizionato sul cavo di alimentazione. Adatto per paralumi: RON 40/25, ASPRO 40/30.

### BEND DA PARETE CON ARCO DI BASE

230 V E27 42 W

R12654 nichel opaco

€ 150

%

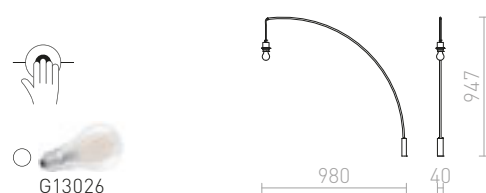



## NIZZA

Piedistallo da tavolo con braccio regolabile in legno e base in metallo laccato. Cavo in tessuto nero. Per paralumi con portalampada E14 o E27.

### NIZZA PIEDISTALLO DA TAVOLO

230 V E14 28 W

R12947 bianco/legno

€ 138 %



G12243

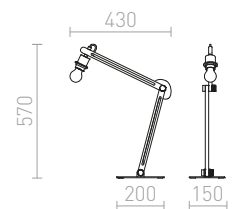

**NIZZA**

Paralume in tessuto adatto per portalampada E27, adatto per installazione su set da sospensione e lampada da tavolo R12947.

**NIZZA 18/15 PARALUME**

max 28 W

**R13113** policotone bianco/PVC bianco

€ 58

**R13114** policotone nero/PVC bianco

€ 58

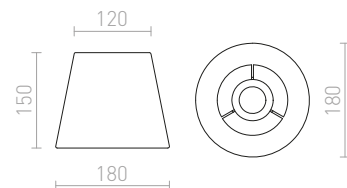
**WOODY**

Piedistallo da tavolo in legno adatto per paralumi con base E27. Interruttore basculante posizionato su portalampada E27 per comando facile. Adatto per paralumi: DELISA 25/16, CONNY 15/30, CONNY 35/30, RON 40/25, TEMPO 30/19.

**WOODY PIEDISTALLO DA TAVOLO**

230 V E27 25 W

**R11791** rovere

€ 98



G13026

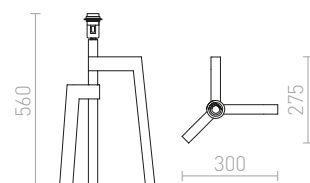





## AMBITUS

Piedistallo da tavolo in bambù con portalamпада E27.  
Paralumi adatti: ALVIS 24/15, DELISA 25/16, CONNY  
15/30, CONNY 35/30, RON 40/25, TEMPO 30/19.

### AMBITUS PIEDISTALLO DA TAVOLO

230 V E27 28 W

R13303 bambù

€ 120



G13026

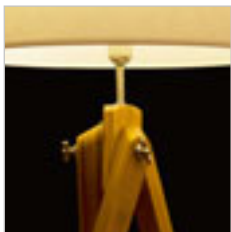
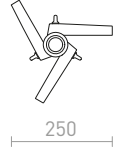
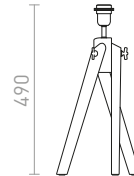

## AMBITUS

Piedistallo da terra in bambù con portalamпада  
E27. Paralumi adatti: AMBITUS 46/24, DELISA 35/30,  
CONNY 25/30, CONNY 35/30, RON 40/25, TEMPO 30/19.

### AMBITUS PIEDISTALLO DA TERRA

230 V E27 28 W

R13304 bambù

€ 258



G13461

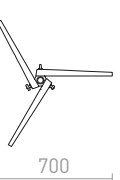
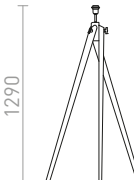





## ALVIS

Piedistallo (treppiede) da terra in bambù, altezza regolabile, con portalampada E27. Adatto per paralumi: AMBITUS 46/24, DELISA 35/30, CONNY 25/30, CONNY 35/30, RON 40/25, TEMPO 30/19.

### ALVIS PIEDISTALLO DA TERRA

230 V E27 28 W

R13340 bambù/cromo

€ 215



G13461

775 - 1210

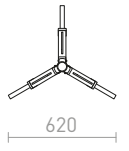

620

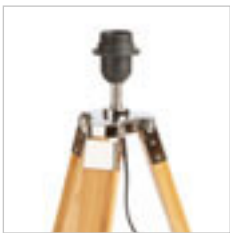

## ALVIS

Piedistallo (treppiede) da tavolo in bambù per paralumi con portalampada E27. Adatto per paralumi: ALVIS 24/15, DELISA 25/16, CONNY 15/30, CONNY 35/30, RON 40/25, TEMPO 30/19.

### ALVIS PIEDISTALLO DA TAVOLO

230 V E27 28 W

R13339 bambù/cromo

€ 98



G13014

510

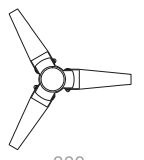
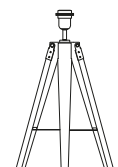

300



## KEITH

Piedistallo da tavolo in imitazione di faggio con porta USB integrata. Da combinare con paralumi con portalamпада E27. Adatto per paralumi: CONNY 15/30, DELI 30/20, DELISA 25/16, RON 15/20.

**KEITH PIEDISTALLO DA TAVOLO CON USB**  
230 V E27 40 W

**R13639** bianco/faggio

**€ 98**



G13026

400

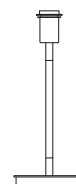

160



## LUTON

Treppiede da terra elegante, in versione nera con particolari in ottone. Da combinare con paralumi con portalamпада E27. Adatta per i paralumi: AMBITUS 46/24, DELISA 35/30, CONNY 25/30, CONNY 35/30, RON 40/25, TEMPO 30/19.

**LUTON PIEDISTALLO DA TERRA**

230 V E27 40 W

**R13640** nero/ottone

**€ 150**



G13026

1000 - 1560



935

600



## MAUI

Piedistallo da tavolo in legno con portalampana E27.  
Paralumi adatti: CONNY 15/30, DELI 30/20, DELISA 25/16, RON 15/20.

### MAUI PIEDISTALLO DA TAVOLO

230 V E27 20 W

R13437 legno

€ 48 %



G13014

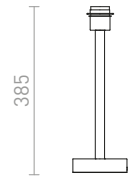

## NYC

Piedistallo da terra in metallo per paralumi con portalampana E27. Adatto per paralumi: CONNY 25/30, CONNY 35/30, JAKARANDA, RON 40/25, TEMPO 30/19.

### NYC TRIPOD PIEDISTALLO DA TERRA

230 V E27 42 W

R11992 cromo

€ 120



G13026

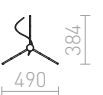



## CORTINA

Piedistallo da tavolo in metallo per paralumi con portalampada E27. Adatto per paralumi: CONNY 15/15, CONNY 15/30, RON 15/20, TEMPO 15/15, TEMPO 15/30.

### CORTINA PIEDISTALLO DA TAVOLO

230 V E27 28 W

R12927 grigio

€ 25 %



G13026

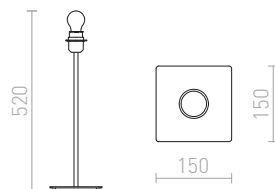

## CORTINA

Piedistallo da terra in metallo per paralumi con portalampada E27. Adatto per paralumi: CONNY 25/30, CONNY 35/30, RON 40/25, TEMPO 30/19.

### CORTINA PIEDISTALLO DA TERRA

230 V E27 28 W

R12930 nero

€ 78

R13809 bianco

€ 78



G13026

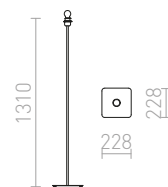



## NYC

Piedistallo da tavolo in metallo lucido e opaco per paralumi con portalampada E27. Adatto per paralumi: CONNY 15/15, CONNY 15/30, RON 15/20, TEMPO 15/15, TEMPO 15/30.

### NYC PIEDISTALLO DA TAVOLO

230 V E27 42 W

**R11990** cromo

€ 48

**R12041** nichel opaco

€ 48



G13026

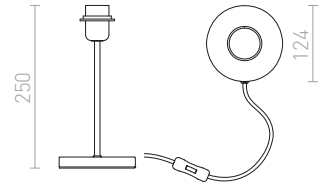

## NYC

Piedistallo da terra in metallo lucido e opaco per paralumi con portalampada E27. Adatto per paralumi: CONNY 25/30, CONNY 35/30, JAKARANDA, RON 40/25, TEMPO 30/19.

### NYC PIEDISTALLO DA TERRA

230 V E27 42 W

**R11991** cromo

€ 120



G13026

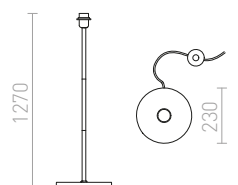





## FIT

Cavo tripolare con treccia tessile in vari colori, lunghezza 4 m.

**FIT 3x0,75 4M CAVO IN TESSUTO**  
230 V

|                      |        |
|----------------------|--------|
| <b>R10251</b> nero   | € 24   |
| <b>R10252</b> bianco | € 14 % |
| <b>R10253</b> rosso  | € 14 % |
| <b>R10254</b> grigio | € 14 % |

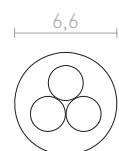

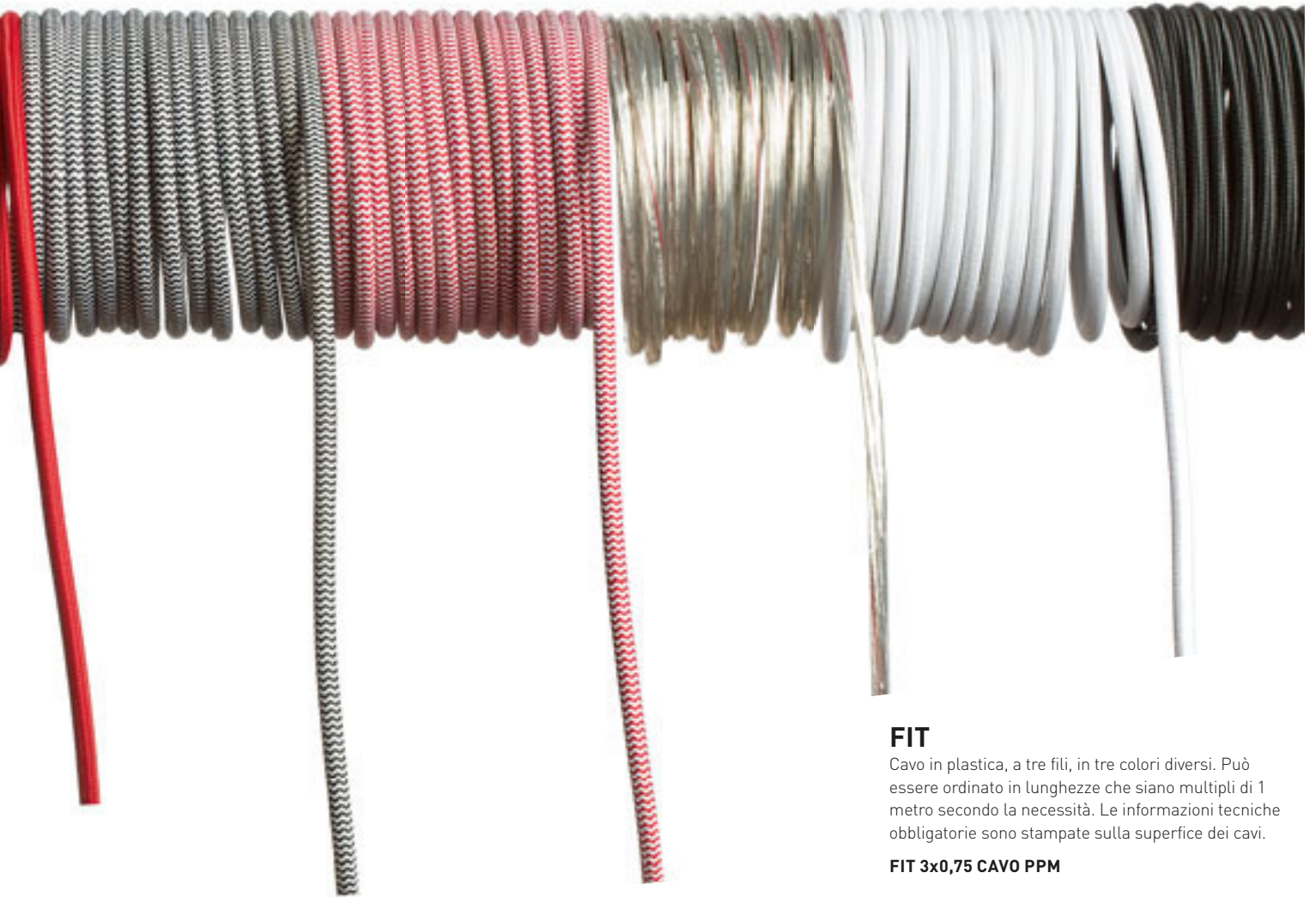

## FIT

Cavo in plastica, a tre fili, in tre colori diversi. Può essere ordinato in lunghezze che siano multipli di 1 metro secondo la necessità. Le informazioni tecniche obbligatorie sono stampate sulla superficie dei cavi.

### FIT 3x0,75 CAVO PPM

|                    |        |
|--------------------|--------|
| R12228 trasparente | € 3.50 |
| R12229 grigio      | € 3.20 |
| R12230 nero        | € 3.20 |

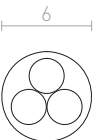

## FIT

Cavo tripolare con treccia tessile in vari colori. Possibile di scegliere lunghezza secondo necessità, cavo tagliato da 1 metro.

### FIT 3x0,75 CAVO IN TESSUTO PPM

|                     |     |
|---------------------|-----|
| R12214 bianco       | € 5 |
| R12216 nero/bianco  | € 5 |
| R12222 nero         | € 5 |
| R12223 grigio       | € 5 |
| R12224 rosso        | € 5 |
| R12225 limetta      | € 5 |
| R12226 fucsia       | € 5 |
| R12227 rosso/bianco | € 5 |

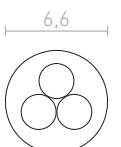
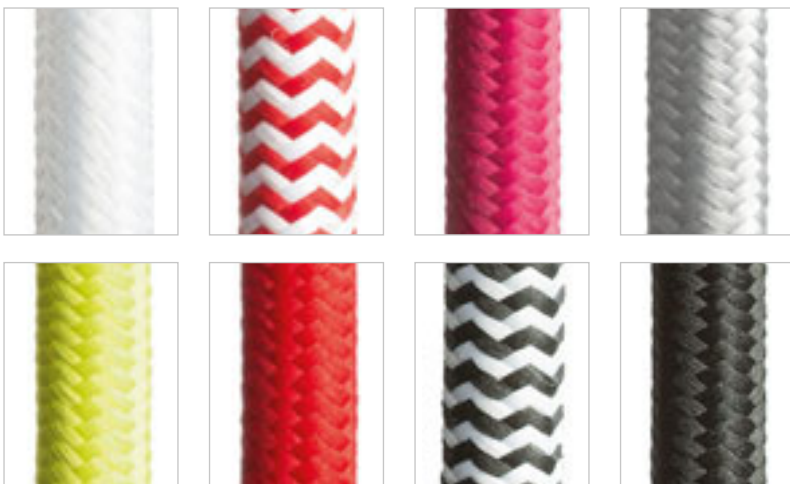

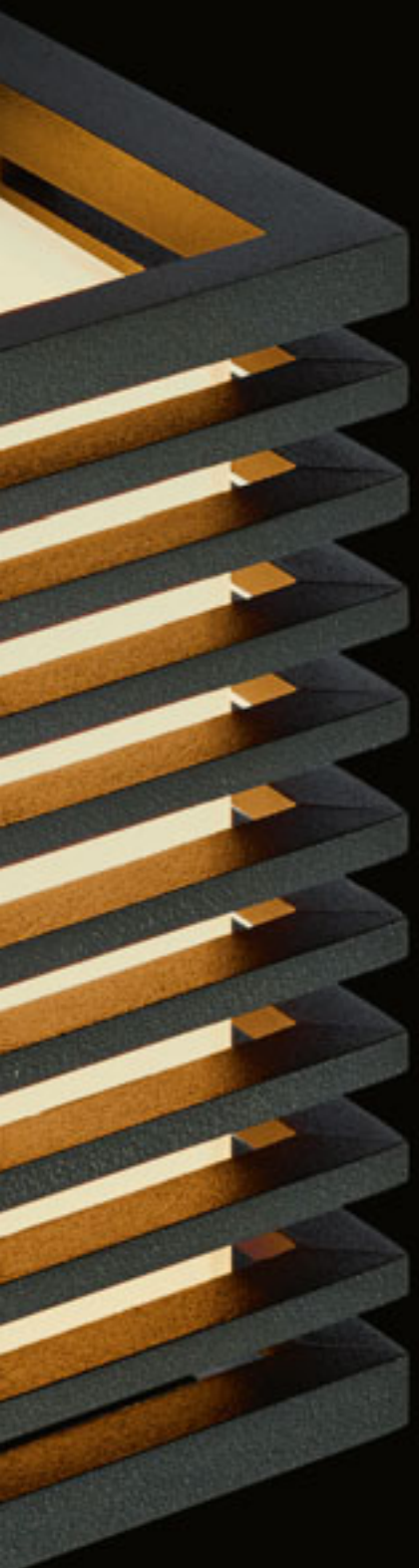

## LUCI DA ESTERNO

|                         |         |
|-------------------------|---------|
| DECORATIVE              | 630-631 |
| SET                     | 632-647 |
| DA SOFFITTO             | 648-655 |
| LUCE INDIRECTA          | 656-657 |
| DA PARETE QUADRATE      | 658-671 |
| UP-DOWN                 | 672-693 |
| DA PARETE DIREZIONABILI | 694-697 |
| CON PICCHETTO           | 698-703 |
| LUCI SEGNAPASSO         | 704-711 |
| DA INCASSO A PARETE     | 712-723 |
| DA INCASSO A TERRA      | 724-725 |

## DA ESTERNO DECORATIVE



**BABYMOON 56**  
630-631



**BEACON**  
630-631

630-631

## DA ESTERNO SET



**ELIA**  
632-633



**ELIA PIR**  
632-633



**ELIA**  
632-633

632-647



**BOSANOVA 120**  
632-633



**BOSANNA 150**  
632-633



**BONNIE**  
634-635



**BONNIE 80**  
634-635



**CLYDE**  
634-635

**CLYDE 60**  
634-635



**VADIS**  
636-637



**VADIS 90**  
636-637



**GARRET**  
636-637



**ABAX 65**  
638-639

**SONET**  
638-639



**SONET 450**  
638-639



**PONDER 20**  
640-641



**PONDER 65**  
640-641



**TREEZA LED 25**  
640-641

**TREEZA 65**  
640-641



**RINA**  
642-643



**RINA**  
642-643



**RINA PIR**  
642-643



**GARDIEN 65**  
642-643





**BOBO RC**  
642-643



**LIZZI**  
644-645



**LIZZI I**  
644-645



**LIZZI II**  
644-645



**SORANO**  
644-645



**SORANO II**  
644-645



**MIZZI NEW I**  
646-647



**MIZZI NEW II**  
646-647



**MIZZI II**  
646-647

## DA ESTERNO DA SOFFITTO



**SENZA R**  
648-649



**ORIN R**  
648-649



**SAMMY**  
648-649

648-655



**MERIDO**  
648-649



**QUADRA M**  
650-651



**RODGE**  
650-651



**KEIG**  
650-651



**SENZA SQ**  
650-651



**ORIN SQ**  
650-651



**SONYA 30**  
652-653



**SONYA RC**  
652-653



**SONNY**  
652-653



**SCOTT**  
654-655



**SPECTACLE**  
654-655



**TARIS SQ 17**  
654-655



**BONO**  
654-655

## DA ESTERNO LUCE INDIRECTA



**ATLANTA 13**  
656-657



**ATHI**  
656-657



**TWIST**  
656-657

## DA ESTERNO DA PARETE QUADRATE



**CLAIRE RC**  
658-659

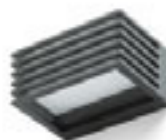

**CLAIRE 14**  
658-659



**CLAIRE 21**  
658-659

658-671



**TIRAS II**  
658-659



**WOOP**  
660-661



**TORINO**  
660-661



**CAMARGUE**  
660-661



**SAMPO**  
660-661



**DURANT**  
662-663



**GINO**  
662-663



**DURANT UP - DOWN**  
662-663



**DELTA 145**  
664-665



**DELTA 145**  
664-665



**DELTA 215**  
664-665



**DELTA 215**  
664-665



**DELTA RC**  
666-667



**CHICAGO**  
666-667



**VERIA**  
666-667



**ATHI**  
666-667



**HIDE SQ**  
668-669



**HIDE RC**  
668-669



**ANDANTE**  
668-669



**VECINO**  
670-671



**CHLOE**  
670-671



**TAPA**  
670-671



**GAVIN**  
670-671

## DA ESTERNO UP-DOWN

672-693



**VIRGO**  
672-673

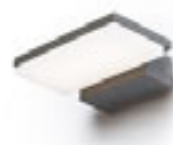

**XYLO**  
672-673



**COMODO**  
672-673



**TWIST**  
672-673



**CABOX II**  
674-675



**TELO**  
674-675



**MIZZI SQ I**  
674-675



**DESMOND II**  
674-675



**CARRE**  
676-677



**TITO R**  
676-677



**TITO SQ**  
676-677



**KANE I**  
678-679



**KANE II**  
678-679



**GRANITA II**  
678-679



**ZAZA**  
680-681



**PIA**  
680-681



**GIGI**  
680-681

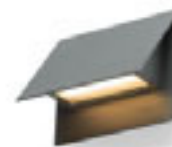

**GERI**  
680-681



**BOURDON**  
682-683



**PIPER**  
682-683



**SIV**  
682-683



**SELMA**  
682-683



**ZACK I**  
684-685



**ZACK II**  
684-685



**BEJA II**  
684-685



**MIDZACK**  
684-685



**KORSO I**  
686-687



**KORSO II**  
686-687



**KUBI I**  
686-687



**KUBI II**  
686-687



**DIXIE 4x12**  
688-689



**DIXIE 10x16**  
688-689



**PEKKO**  
688-689



**UKKO**  
688-689



**NICK II**  
688-689



**MOIRE I**  
690-691



**MOIRE II**  
690-691



**MICO I**  
690-691



**ZANE**  
690-691



**CHOIX 114**  
692-693



**CHOIX 175**  
692-693



**LESA**  
692-693

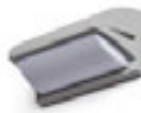

**MORA**  
692-693

## DA ESTERNO DA PARETE DIREZIONABILI

694-697



**DIREZZA**  
694-695



**ORIT**  
694-695



**FOX**  
694-695



**BORA**  
696-697



**PONTA**  
696-697

## DA ESTERNO CON PICCHETTO

698-703



**CORDOBA**  
698-699



**DIREZZA**  
698-699



**GUN**  
698-699



**BLUESTAR**  
698-699



**COSMO**  
700-701



**GARY LED**  
700-701



**BORA**  
700-701



**LORCA**  
700-701



**HEAVY DUTY**  
702-703



**ROSS**  
702-703



**FOX**  
702-703



702-703

## DA ESTERNO LUCI SEGNAPASSO

704-711



**FAROS**  
704-705



**TOPTOP S**  
704-705



**TOPTOP IV**  
704-705



**BOBO R**  
706-707



**BOBO RC**  
706-707



**BOBO SQ**  
706-707



**RENO SQ INDR**  
708-709



**RENO SQ DR**  
708-709



**RENOR**  
708-709



**AQILA R**  
710-711



**AQILA SQ**  
710-711



**AQILA RC**  
710-711



**ITAKA**  
710-711



# DA ESTERNO DA INCASSO A PARETE



**KICK I**  
712-713



**KICK II**  
712-713



**KICK III**  
712-713

712-723



**ASTERIA**  
714-715



**MARCO**  
714-715



**ELICA R**  
714-715



**CLUB**  
714-715



**CLUB IND**  
714-715



**ELICA SQ**  
716-717



**TESS SQ**  
716-717



**PER**  
716-717



**RASQ**  
716-717



**GORDIQ S**  
718-719



**GORDIQ L**  
718-719



**GORDIQ M**  
718-719



**RAGG**  
718-719



**DEJAVU SQ 9**  
720-721



**DEJAVU SQ 14**  
720-721



**FACA**  
722-723



**GAP**  
722-723



**AKORD**  
722-723



**SEGNO**  
722-723

DA ESTERNO  
**DA INCASSO A TERRA**



**NAVY**  
724-725



**TERRA**  
724-725



**ORBUR**  
724-725



**RIZZ SQ 105**  
724-725



**ORBUR SQ 10**  
724-725









IP44

IP44

## BABYMOON

Sfera opalina in materiale termoplastico per sorgenti luminose a risparmio energetico, adatta per utilizzo in giardino. Apparecchio può essere utilizzato sia sospeso che a terra (dopo adattamento). Fornita con cavo di alimentazione da 170 cm.

### BABYMOON 56 A SOSPENSIONE O DA TERRA

230 V E27 23 W IP44

R10372 satinato PE

€ 398

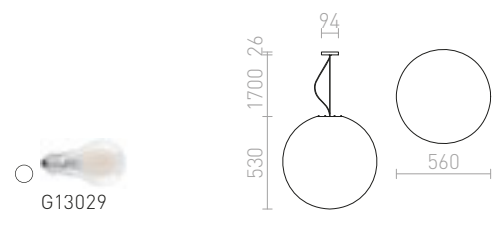

IP44

## BEACON

Applique da esterno in design retrò con paralume in vetro trasparente, compatibile con sorgente luminosa E27.

### BEACON DA PARETE

230 V E27 60 W IP44

R13614 nero/vetro strutturato

€ 120

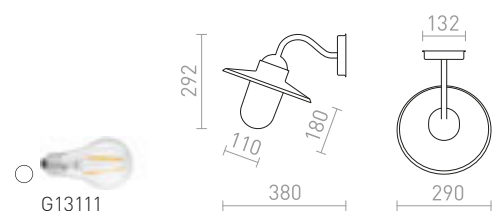



IP65

IP65

## BOSANNOVA

Lampada da terra con paralume in plastica. Il cavo viene fornito con la spina di sicurezza.

### BOSANNOVA 120 DA TERRA

230 V E27 25 W IP65

R12420 grigio antracite/satinato PE

€ 380 →



G13026

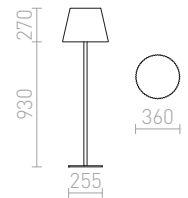

## BOSANNA

Lampada da terra con paralume in plastica. Il cavo viene fornito con la spina di sicurezza.

### BOSANNA 150 DA TERRA

230 V E27 25 W IP65

R12421 grigio antracite/satinato PE

€ 380 →



G13026

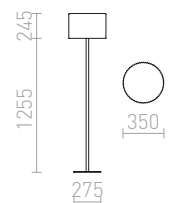





IP44

## ELIA

Lampada a LED per esterni a parete della serie ELIA in una combinazione di alluminio massiccio e diffusore opalino.

### ELIA DA PARETE

230 V LED 9 W 3000 K 720 lm Ra 80 IP44

R13930 grigio antracite

€ 88

NEW

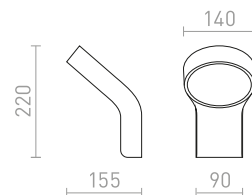

IP44

## ELIA

Lampada a LED per esterni a parete della serie ELIA in una combinazione di alluminio massiccio e diffusore opalino. Incluso un sensore di movimento integrato.

### ELIA PIR DA PARETE

230 V LED 9 W 3000 K 720 lm Ra 80 IP44

R13931 grigio antracite

€ 120

NEW

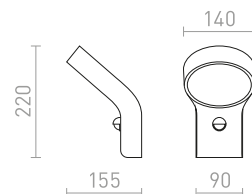

IP44

## ELIA

Lampada a LED da esterno da terra della serie ELIA in una combinazione di alluminio massiccio e un diffusore opalino.

### ELIA DA TERRA

230 V LED 9 W 3000 K 720 lm Ra 80 IP44

R13932 grigio antracite

€ 158

NEW

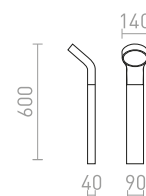



IP44

## BONNIE

Applique esterna con copertura opalina, compatibile con sorgente luminosa a LED con portalampada E27.

### BONNIE DA PARETE

230 V E27 28 W IP44

R13635 grigio antracite

€ 48



G13307

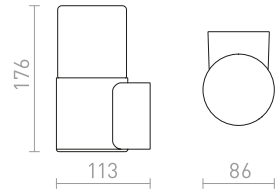

IP44

## BONNIE

Lampada da terra per esterni, con copertura opalina compatibile con sorgente a LED con portalampada E27.

### BONNIE 80 PALETTO

230 V E27 28 W IP44

R13636 grigio antracite

€ 129



G13307

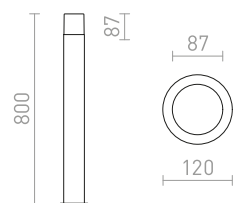



IP44

## CLYDE

Applique esterna con copertura opalina, compatibile con sorgente a LED con portalampada E27.

### CLYDE DA PARETE

230 V E27 28 W IP44

R13637 grigio antracite

€ 58

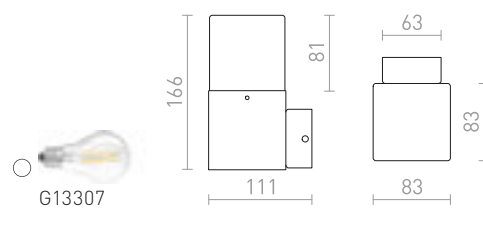

IP44

## CLYDE

Lampada da terra per esterni, con la copertura opalina, compatibile con sorgente a LED con portalampada E27.

### CLYDE 60 PALETTO

230 V E27 28 W IP44

R13638 grigio antracite

€ 120

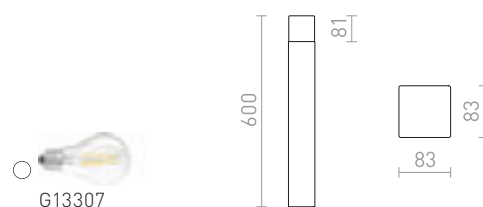



IP65

## GARRET

Applique cilindrica per esterni con LED integrato e illuminazione diffusa.

### GARRET DA PARETE

230 V LED 15 W 3000 K 750 lm Ra 80 IP65

R12548 grigio antracite

€ 88

%

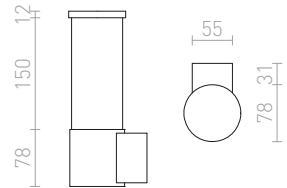

IP54

## VADIS

Applique per esterni con LED integrato e con paralume in acrilico satinato.

### VADIS DA PARETE

230 V LED 8 W 3000 K 520 lm Ra 80 IP54

R10547 grigio antracite

€ 150

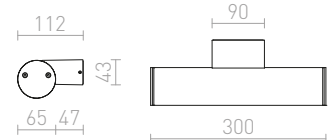

IP54

## VADIS

Paletto esterno a LED integrato in alluminio laccato con paralume in acrilico satinato.

### VADIS 90 PALETTO

230 V LED 8 W 3000 K 520 lm Ra 80 IP54

R10548 grigio antracite

€ 220

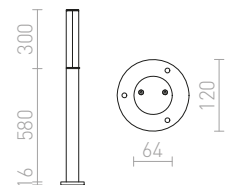









IP54



## SONET

Apparecchio per esterno adatto solo per il montaggio a parete. Grado di protezione IP54 illuminazione solo verso il basso.

### SONET DA PARETE

230 V LED 7 W 3000 K 490 lm Ra 80 IP54

R11170 grigio antracite

€ 129

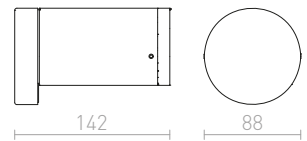
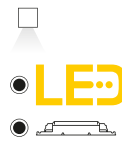

IP54



## ABAX

Paletto esterno con LED integrato per illuminazione in tutte le direzioni.

### ABAX 65 PALETTO

230 V LED 15 W 3000 K 423 lm Ra 80 IP54

R12626 grigio antracite

€ 290

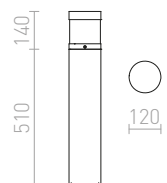



IP54

## SONET

Paletto esterno a LED integrato adatto per illuminare marciapiedi e pavimentazioni.

### SONET 450 PALETTO

230 V LED 7 W  $\angle 55^\circ$  3000 K 477 lm Ra 80 IP54

R11171 grigio antracite

€ 198

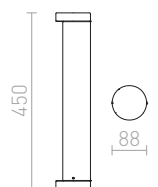
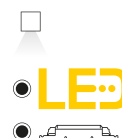



IP54

IP54

## TREEZA

Lampada da terra per esterni, con laccatura interna in oro intorno sorgente luminosa che crea una luce calda e morbida.

### TREEZA LED 25 DA TERRA

230 V LED 7 W  $\angle 60^\circ$  3000 K 123 lm Ra 80 IP54

R10380 grigio antracite

€ 178

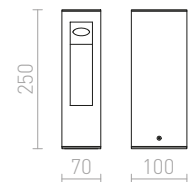

## TREEZA

Lampada da terra per esterni, adatta per sorgente luminosa a risparmio energetico E27. Con vetro frontale satinato.

### TREEZA 65 PALETTO

230 V E27 26 W IP54

R10441 grigio antracite

€ 150

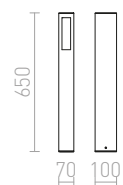





IP44

IP44

## PONDER

Apparecchio da esterno in alluminio pressofuso con paralumi di vetro satinato. Può essere utilizzato sia come applique da parete che da terra.

### PONDER 20 DA PARETE / PALETTO

230 V E27 18 W IP44

R10367 nero

€ 98

R10368 grigio argento

€ 78 →



G13026

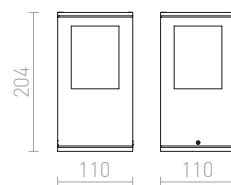

## PONDER

Apparecchio da terra per esterni, adatto per sorgenti luminose a risparmio energetico con portalampada E27 e paralume in vetro satinato.

### PONDER 65 PALETTO

230 V E27 18 W IP44

R10433 nero

€ 158



G13026

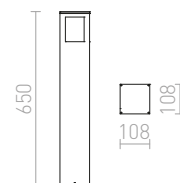



IP65



### BOBO

Lampada da terra da esterno a LED in alluminio per l'illuminazione di orientamento di marciapiedi e vialetti con illuminazione verso il basso.

#### BOBO RC DA TERRA

230 V LED 8 W 3000 K 640 lm Ra 80 IP65

R13936 grigio antracite

€ 150

NEW

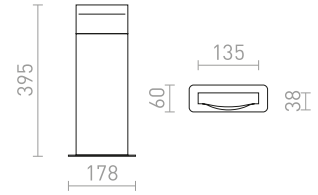
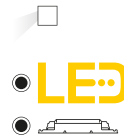

IP44



### RINA

Paletto esterno a LED in alluminio pressofuso con copertura inferiore opalina. Illuminazione verso il basso.

#### RINA PALETTO

230 V LED 12 W 3000 K 1000 lm Ra 80 IP44

R12515 grigio antracite

€ 198

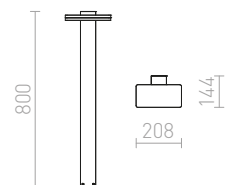
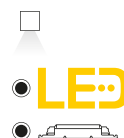





IP65

## RINA

Applique esterna a LED di alluminio pressofuso e copertura inferiore opalina. Illuminazione verso il basso.

### RINA DA PARETE

230 V LED 12 W 3000 K 1000 lm Ra 80 IP65

grigio antracite

€ 150

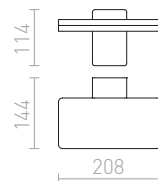
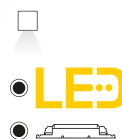

IP65

## RINA

Applique a LED esterna con sensore integrato - possibilità di regolare funzioni. Illuminazione verso il basso. Prodotto in alluminio pressofuso con copertura inferiore opalina.

### RINA PIR DA PARETE

230 V LED 12 W 3000 K 900 lm Ra 80 IP65

R13654 grigio antracite

€ 178

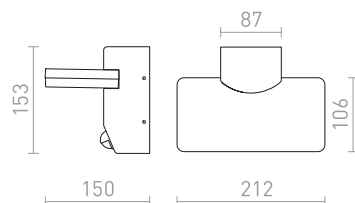
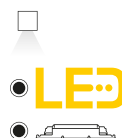

IP54

## GARDIEN

Apparecchio LED da terra per esterni, in alluminio pressofuso con illuminazione monodirezionale verso il basso. I diodi LED sono coperti da un vetro satinato.

### GARDIEN 65 TERRA

230 V LED 10 W 3000 K 600 lm Ra 80 IP54

R13758 nero

€ 178

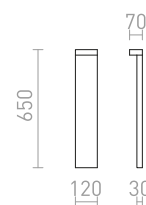
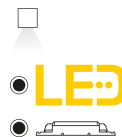



IP54

## LIZZI

Plafoniera da esterno per lampadine con riflettore GU10.

**LIZZI DA SOFFITTO**  
230 V GU10 35 W IP54

**R13505** bianco

€ 58

**R13507** grigio antracite

€ 58

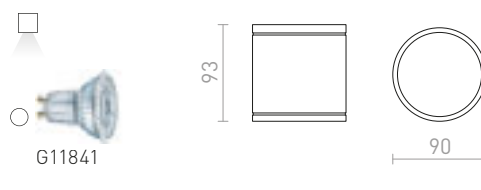

IP54

IP54

## LIZZI

Applique da esterno in alluminio, per sorgenti luminose con portalampada GU10. Dimensione di base 10/6/3,1 cm.

**LIZZI I DA PARETE**  
230 V GU10 35 W IP54

**R13508** grigio antracite

€ 68

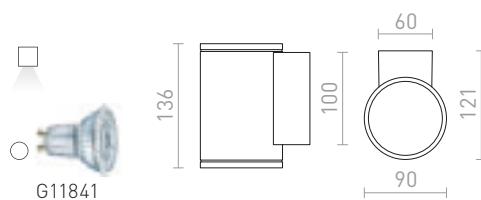

## LIZZI II DA PARETE

230 V GU10 2x35 W IP54

**R13509** grigio antracite

€ 78

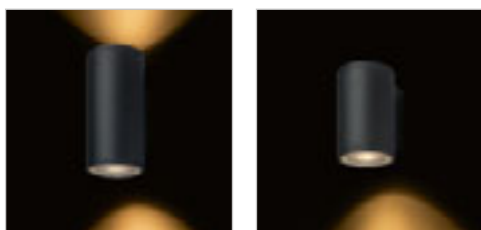
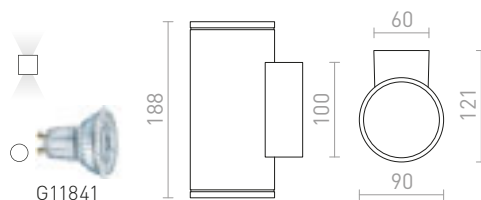



IP44



IP44



## SORANO

Plafoniera cilindrica da esterno in fibre di carbonio, compatibile con sorgente luminosa a LED con portalampada GU10. Il corpo in carbonio dispone di alta resistenza all'acqua salata.

### SORANO DA SOFFITTO

230 V LED GU10 8 W IP44

R13633 nero/plastica

€ 24

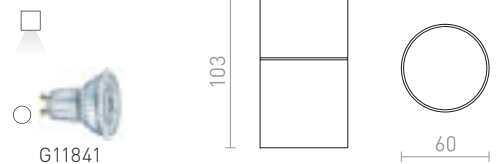

### SORANO II DA PARETE

230 V LED GU10 2x8 W IP44

R13634 nero/plastica

€ 35

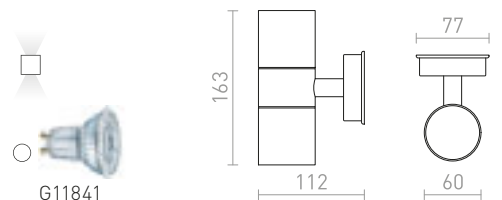



IP65



## MIZZI NEW

Applique esterna in alluminio pressofuso, compatibile con sorgenti luminose con portalampada GU10.

### MIZZI NEW I DA PARETE

230 V GU10 35 W IP65

**R13755** grigio antracite

€ 48

**R13796** grigio argento

€ 48

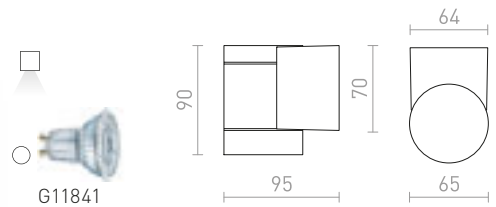

### MIZZI NEW II DA PARETE

230 V GU10 2x35 W IP65

**R13643** grigio antracite

€ 58

**R13797** grigio argento

€ 58

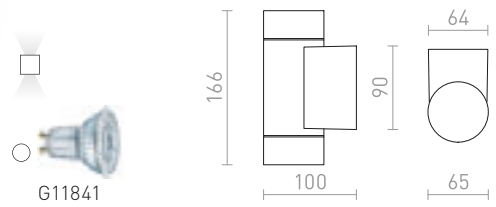

IP54



## MIZZI

Applique esterna in alluminio pressofuso per sorgenti luminose con portalampada GU10.

### MIZZI II

230 V GU10 2x35 W IP54

**R10553** grigio argento

€ 48

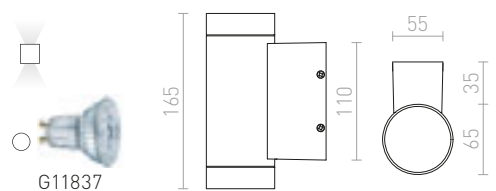









IP54



## MERIDO

Plafoniera da soffitto o da parete esterna per sorgenti luminose a risparmio energetico GX53.

### MERIDO DA SOFFITTO

230 V GX53 11 W IP54

R10428 bianco

€ 58

R10429 grigio argento

€ 58

R10430 grigio antracite

€ 58

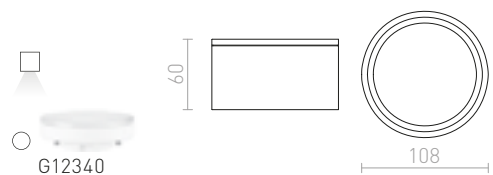



IP54

## ORIN

Plafoniera cilindrica a LED da esterno con paralume in vetro satinato.

### ORIN R DA SOFFITTO

230 V LED 10 W 3000 K 650 lm Ra 80 IP54

R13626 bianco/acrilico satinato

€ 78

R13627 grigio antracite/acrilico satinato

€ 78

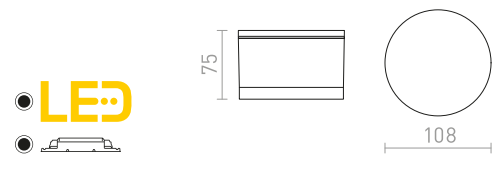

IP65

## SENZA

Plafoniera da esterno a LED. Apparecchio cilindrico con vetro di copertura trasparente con linea decorativa in nero al perimetro.

### SENZA R DA SOFFITTO

230 V LED 6 W 3000 K 480 lm Ra 80 IP65

R13622 bianco/vetro trasparente

€ 98

R13623 grigio antracite/vetro trasparente

€ 98

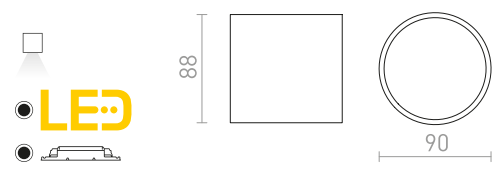

IP54

## SAMMY

Faretto da soffitto per esterno con portalampada GU10. Con copertura inferiore di vetro trasparente.

### SAMMY DA SOFFITTO

230 V LED GU10 15 W IP54

R13450 bianco

€ 58

R13451 grigio

€ 48

R13452 grigio antracite

€ 58

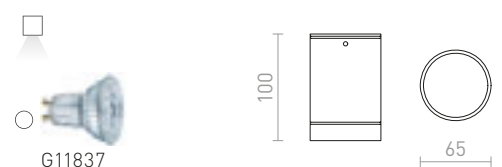



IP65

## KEIG

Plafoniera a LED quadrata per uso esterno compatibile con sorgente luminosa a LED con portalampada GU10.

### KEIG DA SOFFITTO

230 V GU10 35 W IP65

R13631 bianco

€ 48

R13632 nero

€ 48



G11841

103

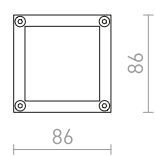

86



IP54

## RODGE

Plafoniera esterna per lampadine a riflettore con portalampada GU10.

### RODGE DA SOFFITTO

230 V GU10 35 W IP54

R13503 bianco

€ 48

R13510 grigio

€ 48

R13511 grigio antracite

€ 58



G11841

94

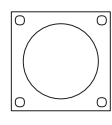
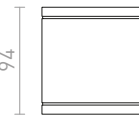

87



IP54

## QUADRA M

Plafoniera cubica esterna per sorgenti luminose alogene PAR20.

### QUADRA M DA SOFFITTO

230 V E27 75 W IP54

R10385 grigio antracite

€ 58

R10386 grigio argento

€ 48



G13020

140

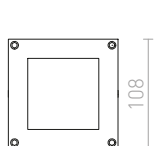
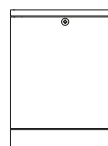

108

108

108

%



IP54

## ORIN

Plafoniera a LED quadrata da esterno con paralume in vetro satinato.

### ORIN SQ DA SOFFITTO

230 V LED 10 W 3000 K 800 lm Ra 80 IP54

**R13628** bianco/acrilico satinato

€ 78

**R13629** grigio antracite/acrilico satinato

€ 78

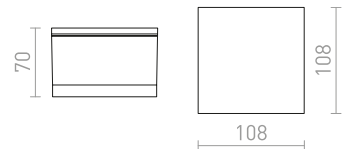

IP65

## SENZA

Plafoniera da esterno a LED. Dispone di vetro di copertura trasparente che all'esterno dell'apparecchio è del colore della lampada.

### SENZA SQ DA SOFFITTO

230 V LED 6 W 3000 K 580 lm Ra 80 IP65

**R13624** bianco/vetro trasparente

€ 88

**R13625** grigio antracite/vetro trasparente

€ 88

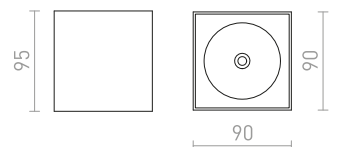
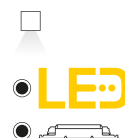









IP54



### SONNY

Plafoniera da esterno per due sorgenti luminose a risparmio energetico.

**SONNY DA SOFFITTO**  
230 V E27 2x18 W IP54

**R10382** grigio antracite  
**R10383** grigio argento

€ 88  
€ 88

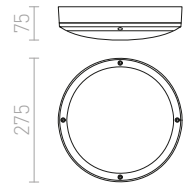

IP54



IP54



### SONYA

Apparecchio da esterno in alluminio con diffusore di acrilico opalino, montaggio da soffitto o da parete.

**SONYA RC**  
230 V E27 2x18 W IP54

**R10363** grigio argento

€ 58 %

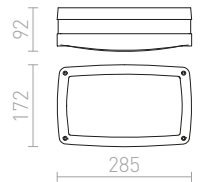

**SONYA 30**  
230 V E27 2x18 W IP54

**R10361** nero  
**R10362** grigio argento

€ 98  
€ 98

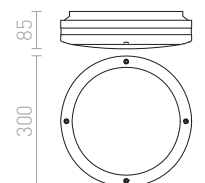



IP65

## BONO

Apparecchio esterno in alluminio pressofuso a LED integrato con diffusore opale. Montaggio da soffitto o da parete.

### BONO PLAFONIERA/APPLIQUE

230 V LED 4 W 3000 K 297 lm Ra 80 IP65

R11967 grigio antracite

€ 150

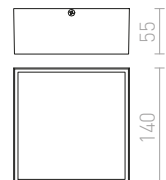
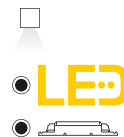



IP54



### SCOTT

Plafoniera/Appliche quadrata a LED integrato per esterni con una copertura in acrilico laccato.

#### SCOTT DA SOFFITTO

230 V LED 9,8 W 3000 K 637 lm Ra 80 IP54

R10552 grigio argento

€ 68

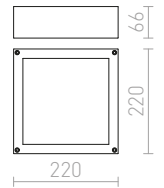
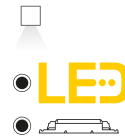

IP54

### TARIS

Appliche/Plafoniera con LED integrato ed angoli arrotondati.

#### TARIS SQ 17 PLAFONIERA/APPLIQUE

230 V LED 8 W 3000 K 550 lm Ra 80 IP54

R12525 nero/plastica

€ 24

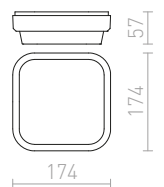

IP54

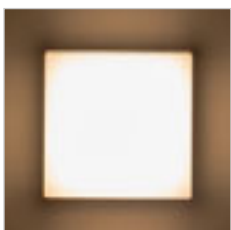

### SPECTACLE

Apparecchio da esterno a LED in alluminio pressofuso con diffusore opalino. Per montaggio a soffitto o a parete.

#### SPECTACLE PLAFONIERA/APPLIQUE

230 V LED 5 W 3000 K 350 lm Ra 80 IP54

R11968 grigio argento

€ 78

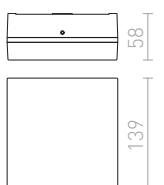

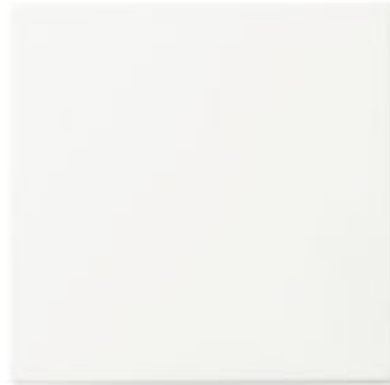
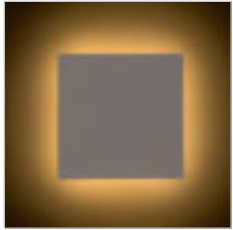

IP54

## ATHI

Applique quadrata con LED integrato per illuminazione indiretta tramite luce riflessa da parete. Sia per interni che per esterni.

### ATHI DA PARETE

230 V LED 9,6 W 3000 K 550 lm Ra 80 IP54

R12551 bianco

€ 120

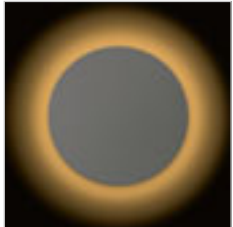
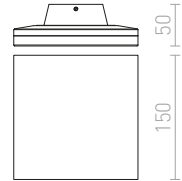

IP54

## ATLANTA

Applique circolare a LED per illuminazione indiretta tramite riflessione da parete. Sia per interni che per esterni.

### ATLANTA 13 APPLIQUE/PLAFONIERA

230 V LED 6 W 3000 K 780 lm Ra 80 IP54

R12825 bianco

€ 78

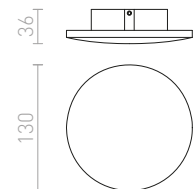





IP65

## TWIST

Applique da esterno a LED in alluminio, con possibilità di regolare l'illuminazione in basso o in direzione opposta come illuminazione indiretta.

### TWIST DA PARETE

230 V LED 12 W 3000 K 980 lm Ra 80 IP65

R13615 bianco

€ 98

R13616 grigio antracite

€ 98

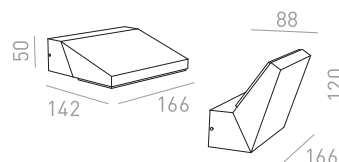





IP54

## TIRAS

Applique a LED da parete per esterni in alluminio pressofuso laccato e con diffusore bianco latte per luce diffusa UP/DOWN.

### TIRAS II DA PARETE

230 V LED 2x6 W 3000 K 371 lm Ra 80 IP54

R13569 grigio antracite/acrilico

€ 78

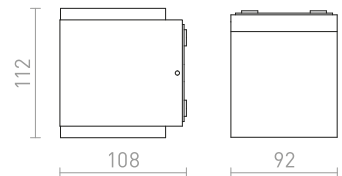
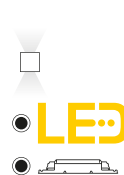

IP54

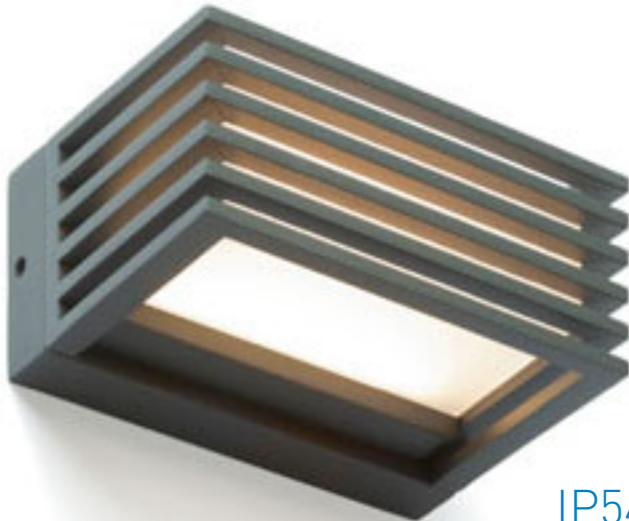
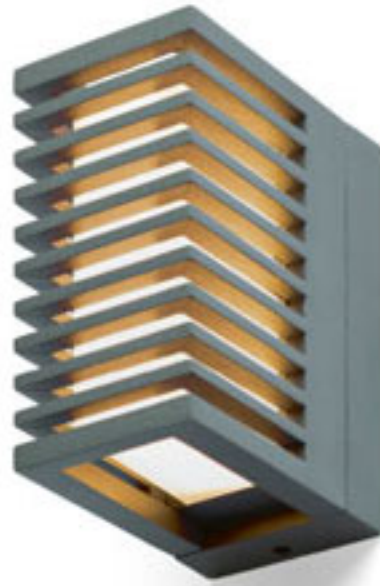

IP54

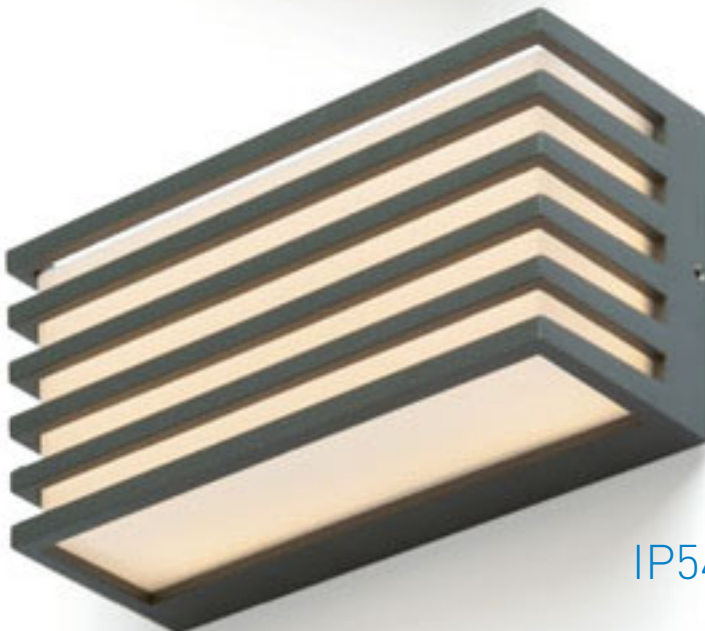

IP54

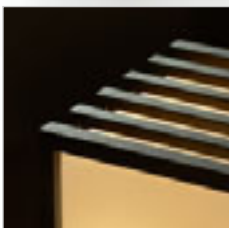

### CLAIRE

Appliche a LED da esterno con corpo in alluminio pressofuso laccato.

#### CLAIRE RC DA PARETE

230 V LED 6 W 3000 K 143 lm Ra 80 IP54

R13563 grigio antracite/acrilico

€ 120

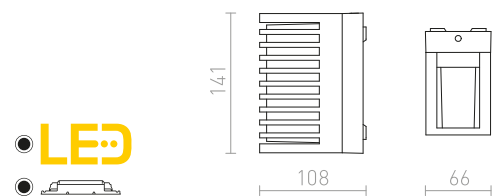

#### CLAIRE 14 DA PARETE

230 V LED 6 W 3000 K 240 lm Ra 80 IP54

R13564 grigio antracite/acrilico

€ 120

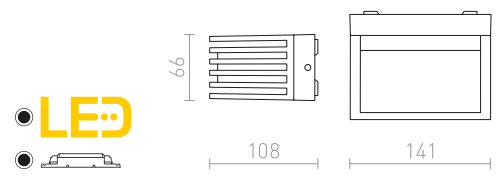

#### CLAIRE 21 DA PARETE

230 V LED 9 W 3000 K 384 lm Ra 80 IP54

R13565 grigio antracite/acrilico

€ 129

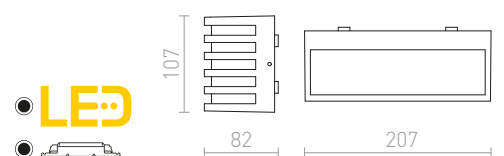

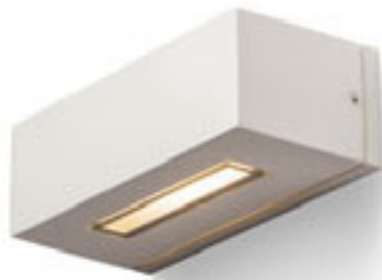

IP54



## WOOD

Applique esterna UP/DOWN. Un lato dell'apparecchio dispone di vetro trasparente con cornice nera. L'altro lato dispone di copertura di vetro satinato più stretto con cornice nera.

### WOOD DA PARETE

230 V R7s 78mm 48 W IP54

R10437 bianco

€ 48

R10438 grigio argento

€ 48

R10439 grigio antracite

€ 58

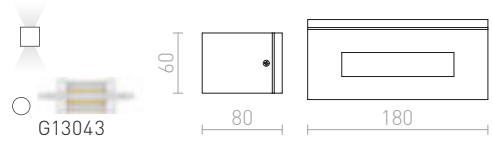

IP54

## TORINO

Applique rettangolare con LED integrato con illuminazione UP/DOWN.

### TORINO DA PARETE

230 V LED 2x5 W 3000 K 550 lm Ra 80 IP54

R12573 bianco

€ 129

R12574 nero

€ 129

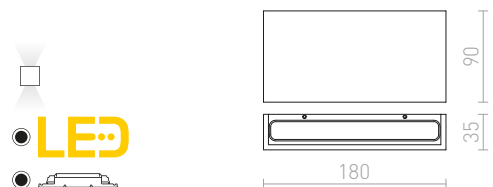



IP65

### SAMPO

Applique da esterno in alluminio a LED, in forma rettangolare con illuminazione inferiore asimmetrica.

#### SAMPO DA PARETE

230 V LED 9 W 3000 K 650 lm Ra 80 IP65

R13619 grigio antracite

€ 98

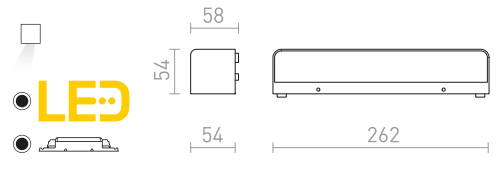

IP65

### CAMARGUE

Applique a LED rettangolare con illuminazione verso il basso.

#### CAMARGUE DA PARETE

230 V LED 6 W 3000 K 550 lm Ra 80 IP65

R13527 grigio argento/vetro satinato

€ 129

R13641 grigio antracite/vetro satinato

€ 129

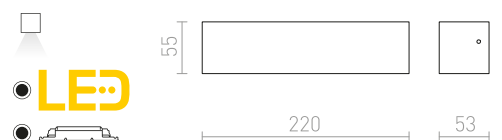



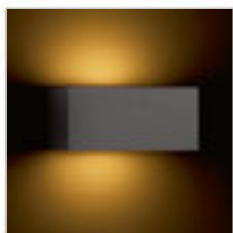

IP54



IP54

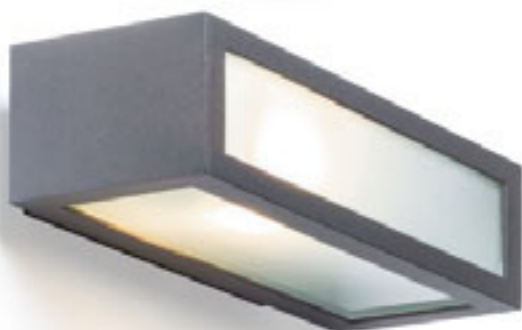

IP44

## DURANT

Applique esterna rettangolare con illuminazione UP/DOWN per sorgenti luminose a risparmio energetico E27.

### DURANT UP - DOWN DA PARETE

230 V E27 18 W IP54

R12559 grigio antracite

€ 120

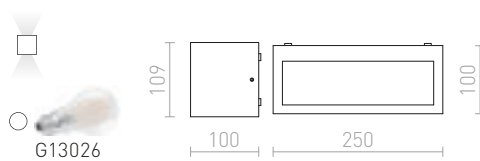

## DURANT

Applique esterna per illuminazione diffusa, adatta con sorgenti luminose a risparmio energetico E27.

### DURANT PARETE

230 V E27 18 W IP54

R12568 grigio argento

€ 88

R12569 grigio antracite

€ 98

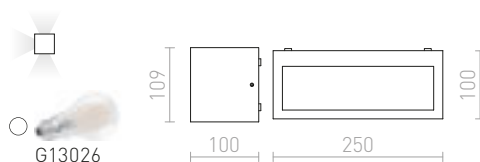

## GINO

Applique esterna con vetri satinati. Dimensioni di base 20x6x2 cm (LuxLaxAl).

### GINO DA PARETE

230 V E27 18 W IP44

R10387 grigio antracite

€ 98

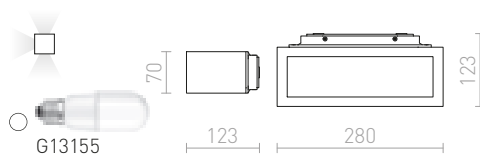











IP54



IP54



IP54



IP54

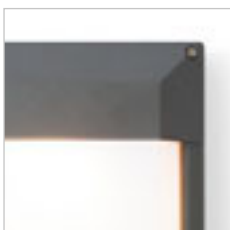

## DELTA

Applique da esterno, adatta per terrazze ed ingressi di casa, per sorgenti luminose GX53 o E27 a risparmio energetico.

### DELTA 145 APPLIQUE/PLAFONIERA

230 V GX53 9 W IP54

R12563 grigio antracite

€ 48

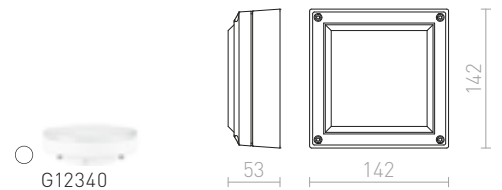

### DELTA 215 APPLIQUE/PLAFONIERA

230 V E27 18 W IP54

R12564 grigio antracite

€ 88

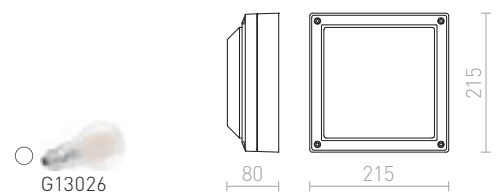

## DELTA

Applique da esterno, adatta per terrazze ed ingressi di casa, per sorgenti luminose GX53 o E27 a risparmio energetico.

### DELTA 145 DA PARETE

230 V GX53 9 W IP54

R12565 grigio antracite

€ 48

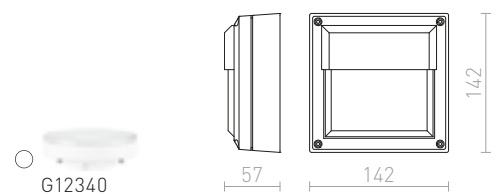

### DELTA 215 DA PARETE

230 V E27 18 W IP54

R12566 grigio antracite

€ 88

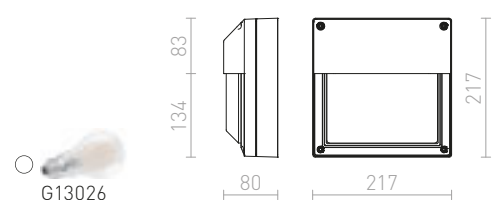

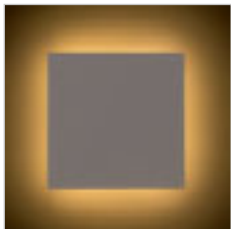

IP54

## ATHI

Applique quadrata con LED integrato per illuminazione indiretta tramite luce riflessa da parete. Sia per interni che per esterni.

### ATHI DA PARETE

230 V LED 9,6 W 3000 K 550 lm Ra 80 IP54

R12551 bianco

€ 120

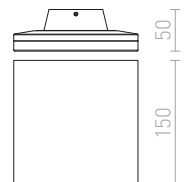





IP54

## DELTA

Applique da esterno, adatta per sorgenti luminose E27 a risparmio energetico. Con illuminazione diffusa.

### DELTA RC DA PARETE

230 V E27 18 W IP54

R12567 grigio antracite

€ 78 %

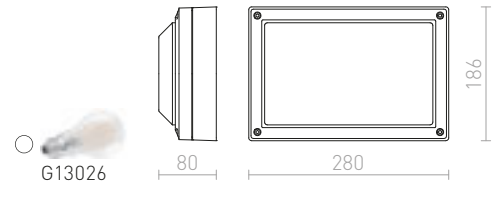

IP44

## CHICAGO

Apparecchio da esterno realizzato in alluminio pressofuso con diffusore opalino. Da utilizzare con sorgente luminosa a risparmio energetico con portalampada E27.

### CHICAGO DA PARETE

230 V E27 18 W IP44

R12018 grigio antracite

€ 68

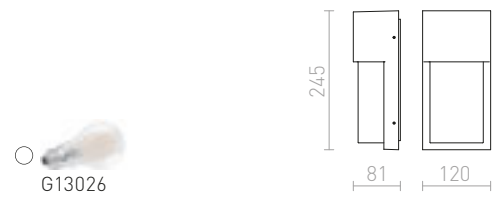

IP54

## VERIA

Applique da esterno piatta con LED integrato.

### VERIA DA PARETE

230 V LED 6 W  $\angle 116^\circ$  3000 K 629 lm Ra 80 IP54

R11169 grigio argento

€ 120 %

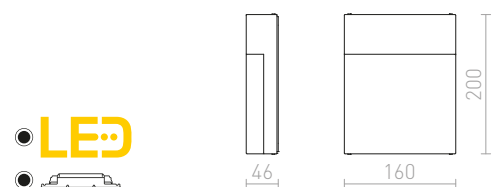







IP54

### HIDE

Applique da esterno con luce soffusa, adatta per terrazze ed ingressi di casa. Per sorgente luminosa a risparmio energetico E27.

#### HIDE RC DA PARETE

230 V E27 18 W IP54

R12561 grigio antracite

€ 98

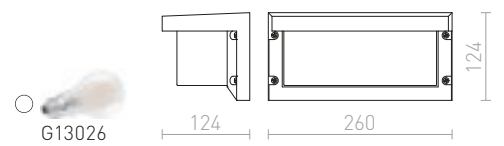

IP44

#### HIDE SQ DA PARETE

230 V E27 13 W IP44

R12560 grigio antracite

€ 88

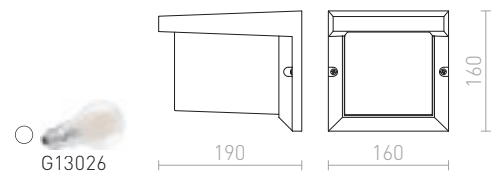

IP65

### ANDANTE

Applique con LED incorporato, adatta per illuminazione di terrazze o ingressi di abitazioni.

#### ANDANTE DA PARETE

230 V LED 21 W 3000 K 1200 lm Ra 80 IP65

R13504 grigio antracite/acrilato opaco

€ 138

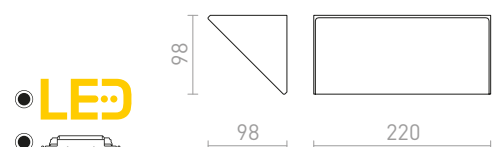



IP54

## TAPA

Applique rettangolare UP/DOWN LED da esterno in metallo laccato.

### TAPA DA PARETE

230 V LED 6 W 3000 K 277 lm Ra 80 IP54

R13562 bianco

€ 68 →

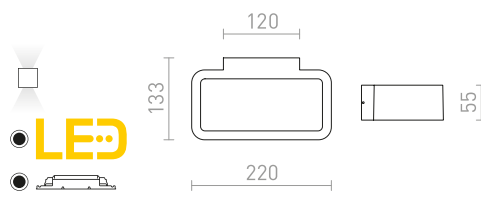

IP54

## VECINO

Applique esterna in alluminio pressofuso con copertura inferiore opalina.

### VECINO DA PARETE

230 V LED 5 W 3000 K 330 lm Ra 80 IP54

R10351 grigio argento

€ 58 %

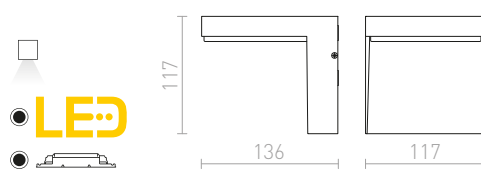

IP65

## CHLOE

Applique rettangolare a LED in acciaio inossidabile, per illuminazione indiretta. Adatta sia per esterni che per interni.

### CHLOE DA PARETE

230 V LED 9 W 3000 K 800 lm Ra 80 IP65

R11752 acciaio inossidabile

€ 120 →

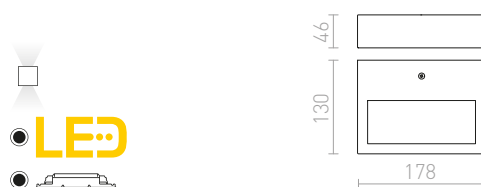



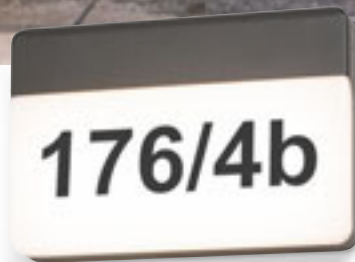
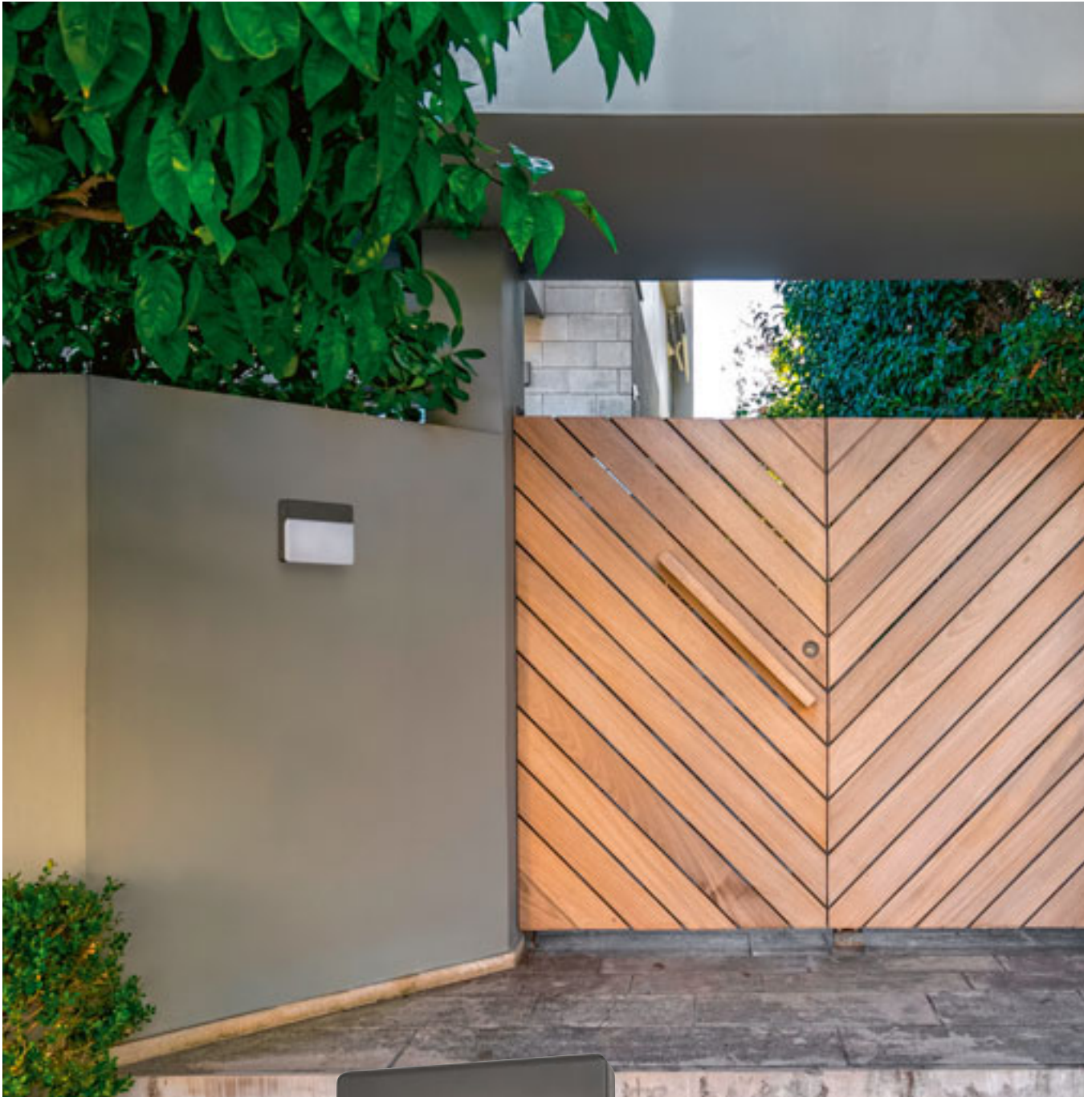

IP65

### GAVIN

Applique LED piatto da esterno adatto per illuminare porte d'ingresso, corridoi o scale. L'apparecchio è anche adatto per incollare numeri o altri simboli (non forniti).

#### GAVIN DA PARETE

230 V LED 13 W 3000 K 650 lm Ra 80 IP65

R13756 grigio antracite/acrilico

€ 120

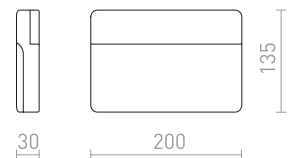



## COMODO

Applique con LED incorporato per illuminazione verso il basso obliquamente.

### COMODO DA PARETE

230 V LED 20 W 3000 K 940 lm Ra 80 IP65

R13512 grigio antracite

€ 150

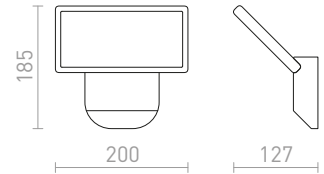
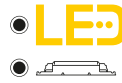

## VIRGO

Applique esterna a LED integrato in alluminio pressofuso con copertura inferiore opalina. L'illuminazione verso il basso.

### VIRGO DA PARETE

230 V LED 9 W 3000 K 800 lm Ra 80 IP65

R11946 grigio antracite

€ 88

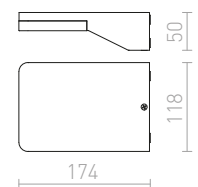
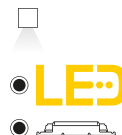





IP65

## TWIST

Appliche da esterno a LED in alluminio, con possibilità di regolare l'illuminazione in basso o in direzione opposta come illuminazione indiretta.

### TWIST DA PARETE

230 V LED 12 W 3000 K 980 lm Ra 80 IP65

R13615 bianco

€ 98

R13616 grigio antracite

€ 98

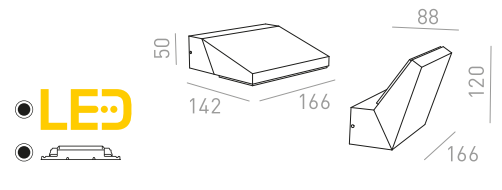

IP54



## XYLO

Appliche da esterno con LED integrato per illuminazione verso il basso.

### XYLO DA PARETE

230 V LED 8 W 3000 K 590 lm Ra 80 IP54

R12562 grigio antracite

€ 120





## MIZZI

Applique esterna in alluminio pressofuso con diodo LED di 12W integrato ad alta luminosità. Driver incluso.

### MIZZI SQ I DA PARETE

230 V LED 12 W  $\angle 44^\circ$  3000 K 846 lm Ra 80 IP54

R11964 grigio antracite

€ 129 %

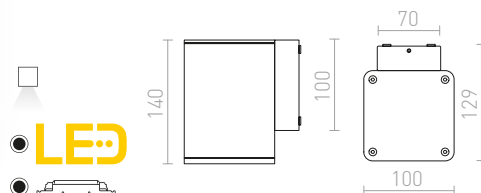

IP44

## TELO

Applique esterna UP/DOWN con aperture di vetro trasparente.

### TELO DA PARETE

230 V G9 40 W IP44

R10554 grigio antracite

€ 68

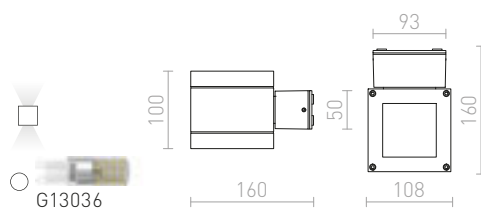

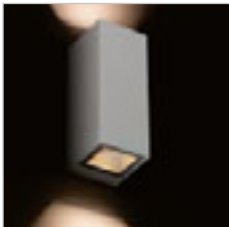

IP44

## DESMOND

Applique da esterno in alluminio, con illuminazione UP/DOWN, compatibile con due lampadine LED con portalampada GU10.

### DESMOND II DA PARETE

230 V GU10 2x35 W IP44

R13609 bianco

€ 68

R13610 grigio argento

€ 68

R13611 grigio antracite

€ 68

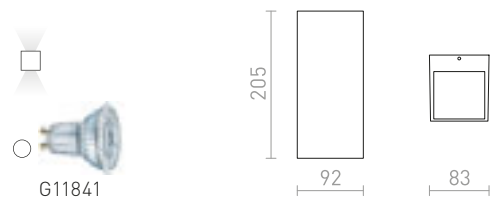

IP54

## CABOX

Applique da esterno UP/DOWN, adatto per sorgenti luminose con portalampada E27.

### CABOX II DA PARETE

230 V E27 70 W IP54

R10384 grigio antracite

€ 88

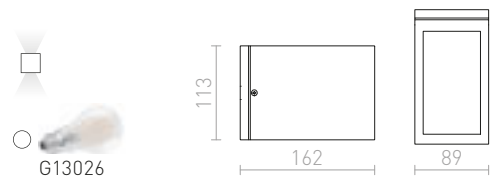



IP65



IP65

## TITO

Applique da parete a LED con illuminazione UP/DOWN, con fascio di luce regolabile. Dimmerazione TRIAC.

### TITO R DIMM DA PARETE

230 V LED 2x3 W 3000 K 500 lm Ra 80 IP65

R13736 bianco

€ 88

R13737 nero

€ 88

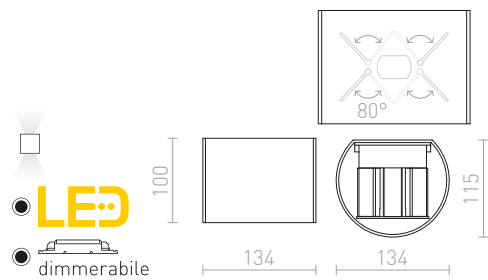

### TITO SQ DIMM DA PARETE

230 V LED 2x3 W 3000 K 500 lm Ra 80 IP65

R13738 bianco

€ 88

R13739 nero

€ 88

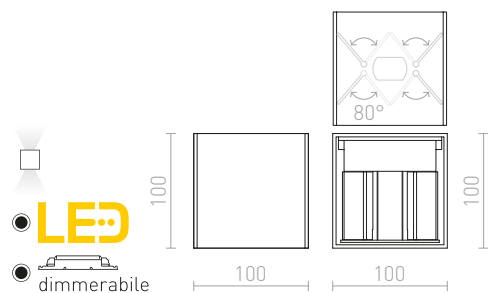



IP54

## CARRE

Appliche quadrata con LED integrato per illuminazione UP/DOWN, con possibilità di regolare il fascio luminoso.

### CARRE DA PARETE

230 V LED 2x3 W 3000 K 200 lm Ra 80 IP54

R12556 bianco

€ 88

R12557 grigio antracite

€ 88

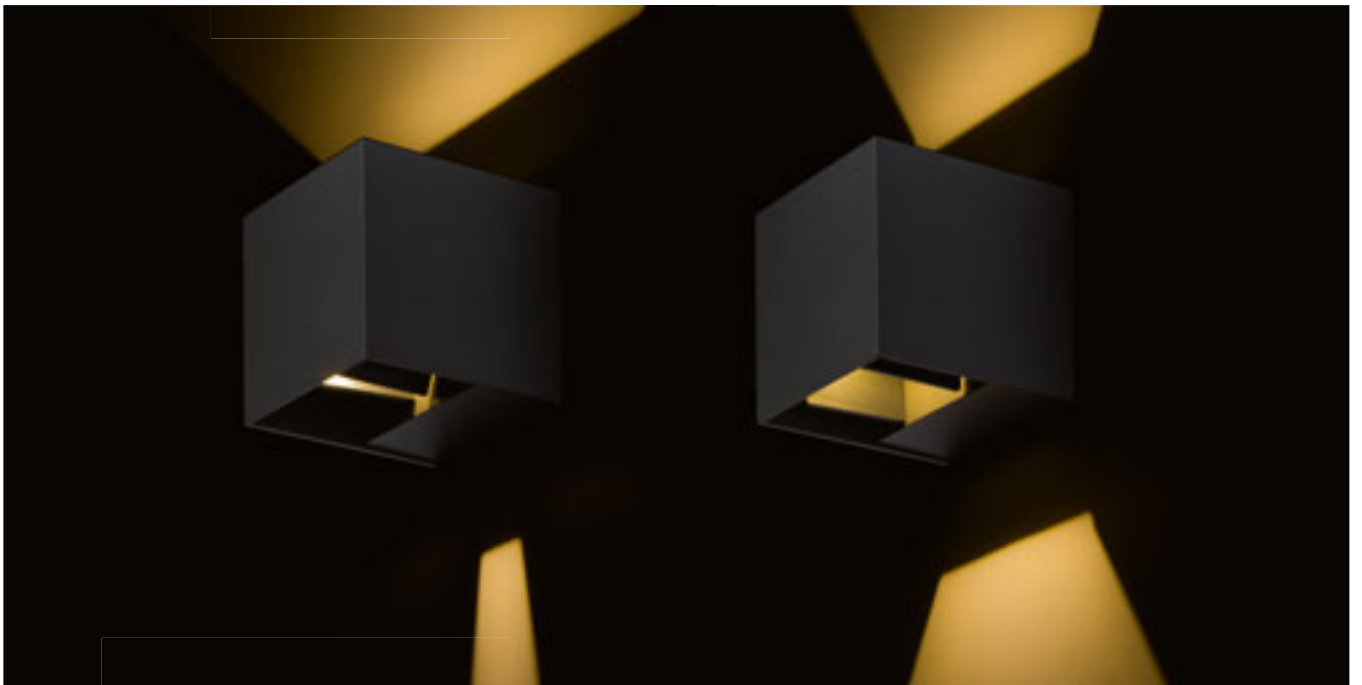
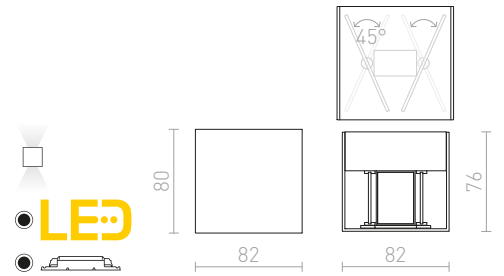

IP54

## TITO

Appliche da parete a LED con illuminazione UP/DOWN, con fascio di luce regolabile.

### TITO SQ DA PARETE

230 V LED 6 W 3000 K 500 lm Ra 80 IP54

R12601 alluminio spazzolato

€ 78

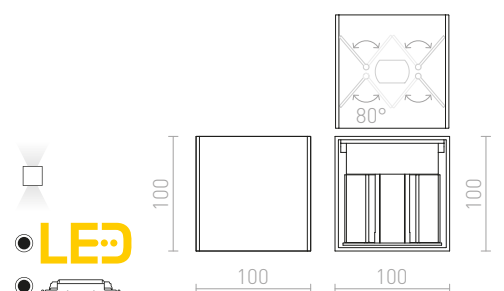







IP65

## GRANITA

Apparecchio da parete da esterno di calcestruzzo, per sorgenti luminose a LED con portalampada GU10.

### GRANITA II DA PARETE

230 V LED GU10 2x5 W IP65

R13792 calcestruzzo/granito chiaro decor

€ 120

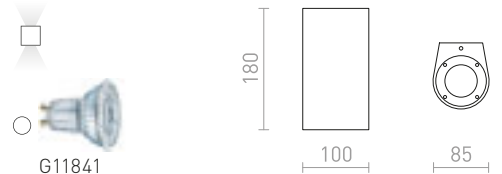

IP65

## KANE

Apparecchio da parete da esterno in calcestruzzo, adatto per sorgenti luminose a LED con portalampada GU10.

### KANE I DA PARETE

230 V LED GU10 5 W IP65

R13793 calcestruzzo/granito scuro decor

€ 88

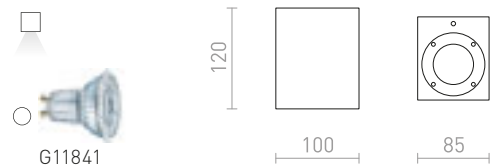

### KANE II DA PARETE

230 V LED GU10 2x5 W IP65

R13794 calcestruzzo/granito scuro decor

€ 120

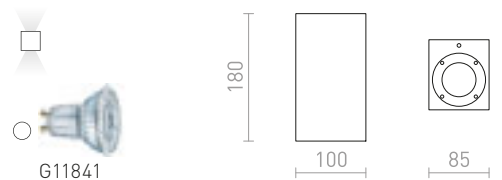



IP54



IP65

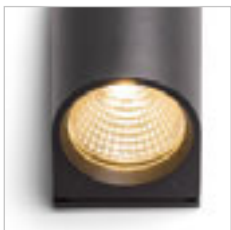

## PIA

Applique esterna UP/DOWN in alluminio pressofuso con LED integrato.

### PIA DA PARETE

230 V LED 2x3 W 3000 K 270 lm Ra 80 IP54

R12010 grigio antracite

€ 68

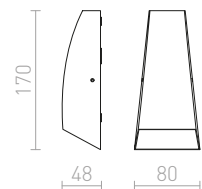
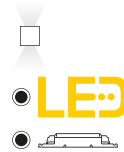

## ZAZA

Applique esterna da parete con copertura di vetro trasparente.

### ZAZA DA PARETE

230 V LED 3,3 W 3000 K 250 lm Ra 80 IP65

R10398 grigio antracite

€ 78 %

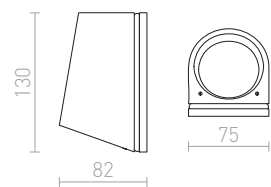
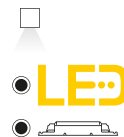



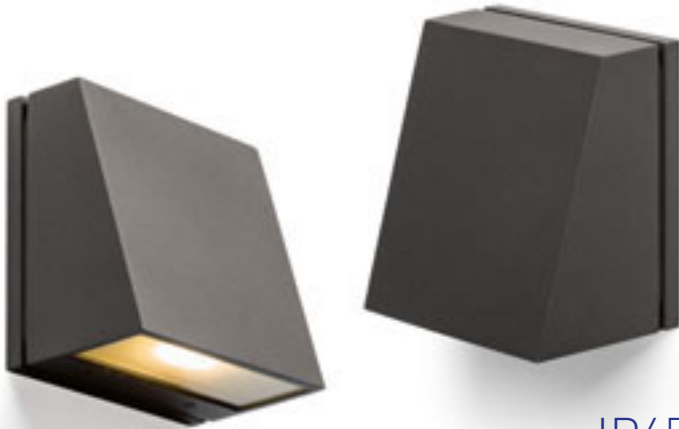

IP65

### GIGI

Appliche esterna con vetro di copertura opaco.

#### GIGI DA PARETE

230 V LED 3,3 W 3000 K 250 lm Ra 80 IP65

R10399 grigio antracite

€ 98

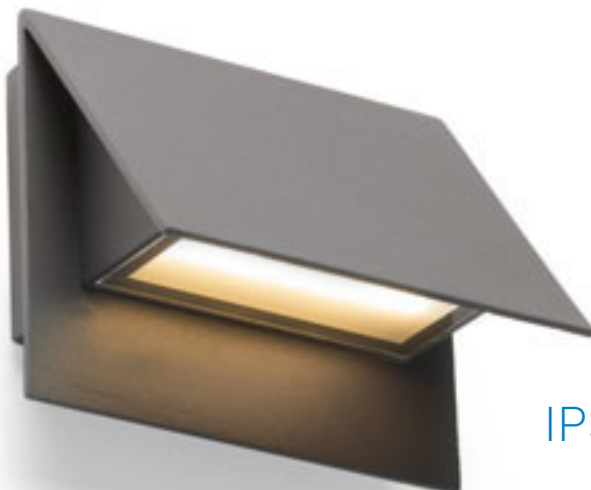
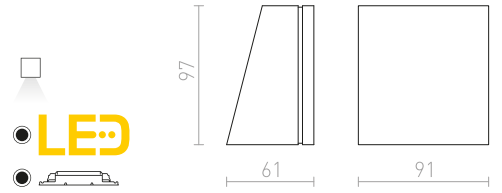

IP54

### GERI

Appliche LED da esterno in alluminio, con illuminazione verso il basso.

#### GERI DA PARETE

230 V LED 5 W 3000 K 211 lm Ra 80 IP54

R13561 grigio antracite

€ 88

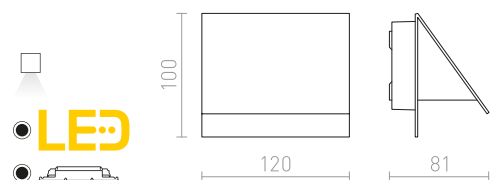

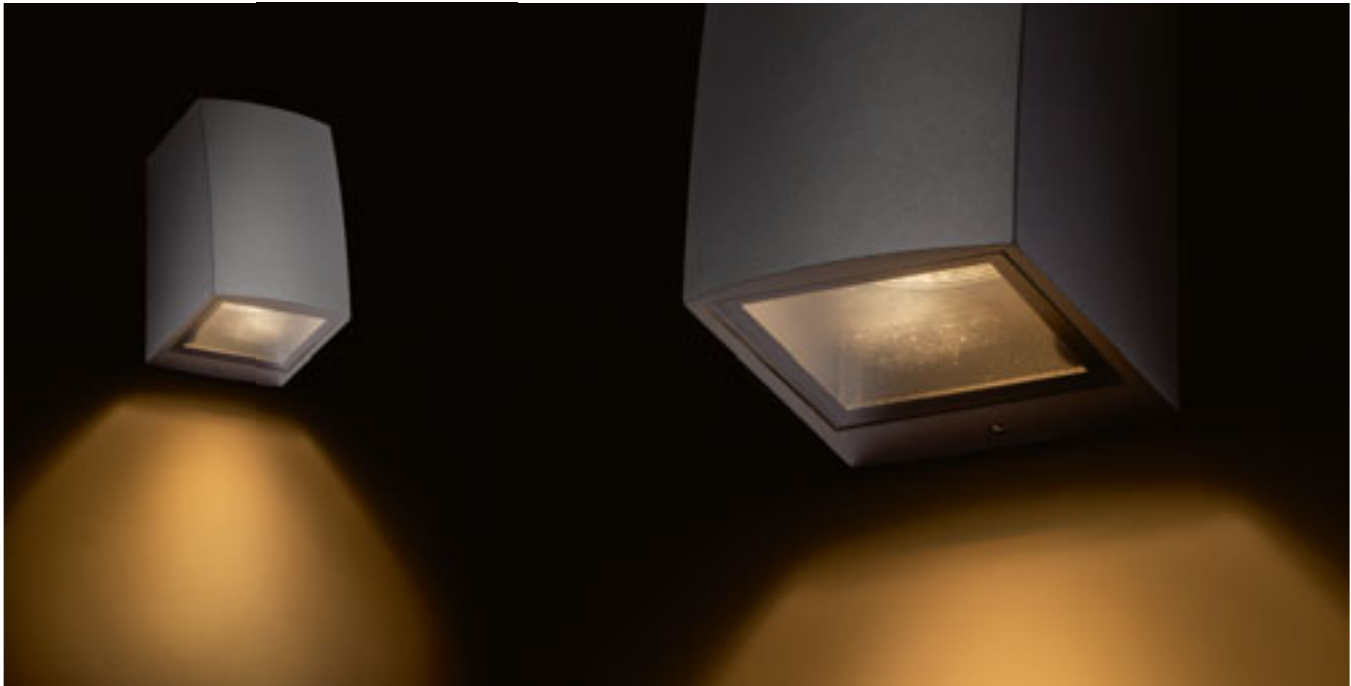

IP54

## SELMA

Appliche da esterno in alluminio con portalampada GU10.

**SELMA DA PARETE**  
230 V GU10 35 W IP54

|                                |      |
|--------------------------------|------|
| <b>R13513</b> bianco           | € 35 |
| <b>R13514</b> grigio argento   | € 35 |
| <b>R13515</b> grigio antracite | € 35 |

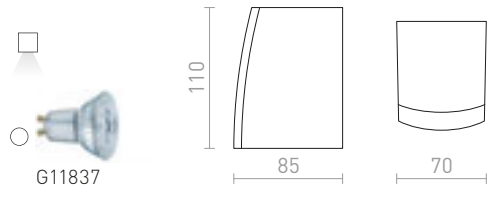

IP54

## SIV

Appliche arrotondate con LED incorporato e illuminazione verso il basso obliquamente. Adatta per corridoi.

**SIV PLAFONIERA/APPLIQUE**  
230 V LED 6 W  $\angle 120^\circ$  3000 K 360 lm Ra80 IP54

|                                |      |
|--------------------------------|------|
| <b>R13502</b> grigio antracite | € 78 |
|--------------------------------|------|

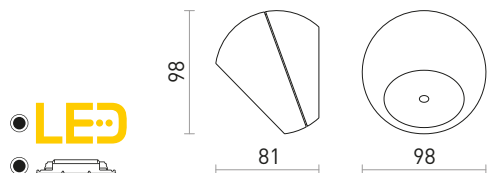





IP54

### BOURDON

Applique da esterno per sorgenti luminose con portalampada GU10. Corpo realizzato in alluminio pressofuso laccato.

#### BOURDON DA PARETE

230 V GU10 35 W IP54

R13559 grigio antracite

€ 48

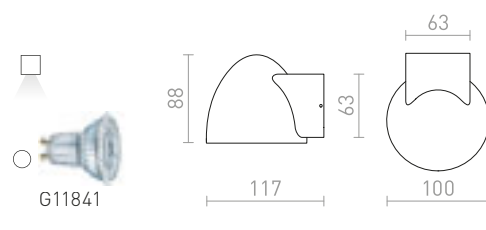

IP54

### PIPER

Applique a tubo da esterno a LED con illuminazione verso il basso.

#### PIPER DA PARETE

230 V LED 6 W 3000 K 489 lm Ra 80 IP54

R13560 grigio antracite

€ 78

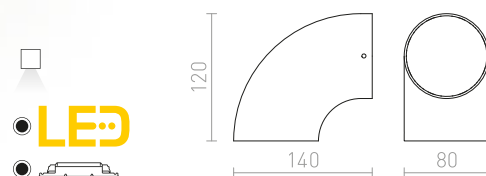



IP54



IP54

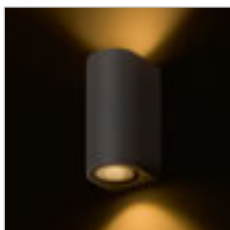

## ZACK

Apparecchio esterno da parete a LED integrato in alluminio pressofuso.

### ZACK II

230 V LED 2x3 W  $\angle 58^\circ$  3000 K 315 lm Ra 80 IP54

R12022 grigio antracite

€ 78

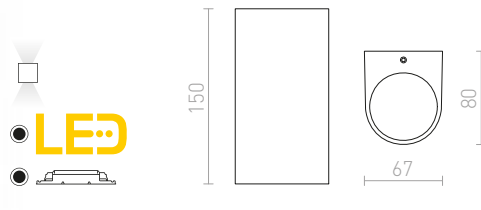

### ZACK I

230 V LED 3 W  $\angle 58^\circ$  3000 K 176 lm Ra 80 IP54

R12027 grigio antracite

€ 58

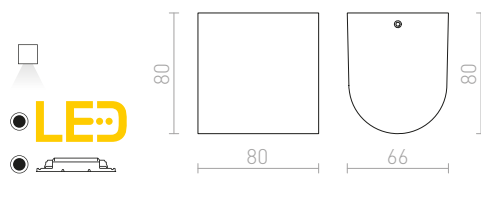

IP54

## MIDZACK

Apparecchio da parete arrotondato per illuminazione UP/DOWN con LED integrato.

### MIDZACK DA PARETE

230 V LED 2x3 W 3000 K 480 lm Ra 80 IP54

R12585 bianco

€ 88 

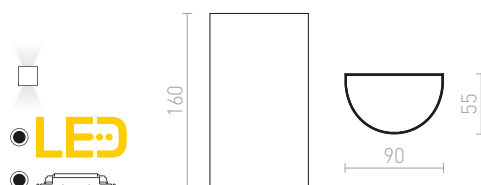



IP65

## BEJA

Applique da esterno UP/DOWN in alluminio pressofuso. L'apparecchio è dotato di LED ad alta prestazione.

### BEJA II DA PARETE

230 V LED 2x9 W  $\angle 24^\circ$  3000 K 670 lm Ra 80 IP65

R13757 grigio antracite

€ 138

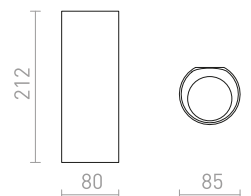
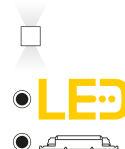



IP54

### KUBI

Applique esterna a LED integrato in alluminio pressofuso.

#### KUBI I

230 V LED 3 W  $\angle 56^\circ$  3000 K 176 lm Ra 80 IP54

R12021 grigio antracite

€ 58

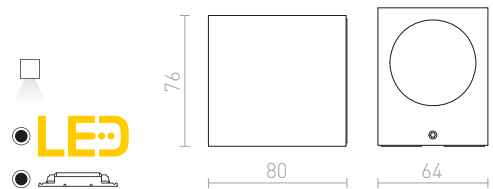

IP54

#### KUBI II

230 V LED 2x3 W  $\angle 56^\circ$  3000 K 315 lm Ra 80 IP54

R12028 grigio antracite

€ 68

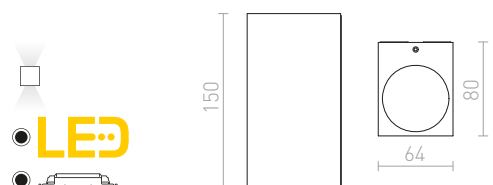

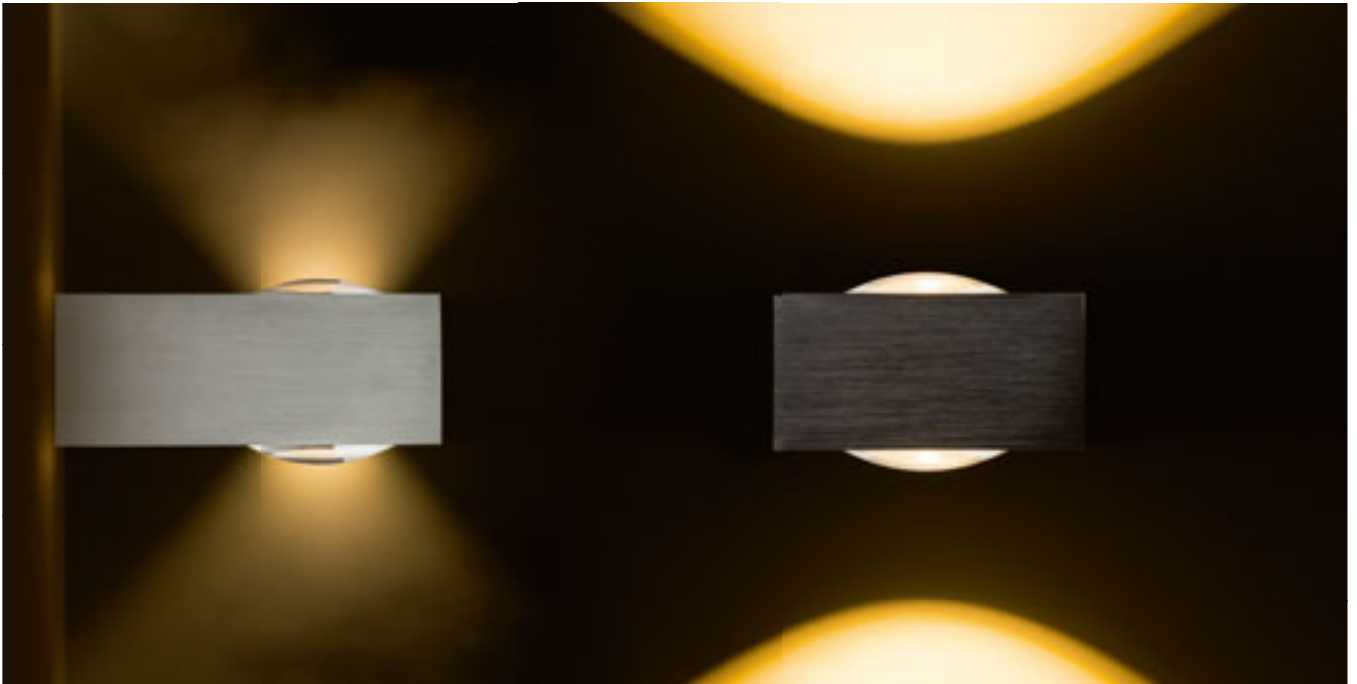

IP54

### KORSO

Apparecchio da parete con LED integrato per uso esterno e interno. Realizzato in alluminio spazzolato con finitura naturale o nero anodizzato.

#### KORSO II DA PARETE

230 V LED 2x3 W  $\angle 120^\circ$  3000 K 780 lm Ra 80 IP54

R12831 alluminio spazzolato

€ 68 %

R12832 nero anodizzato

€ 68 %

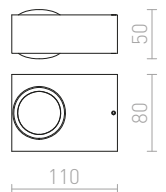

IP54

#### KORSO I DA PARETE

230 V LED 5 W  $\angle 120^\circ$  3000 K 390 lm Ra 80 IP54

R12829 alluminio spazzolato

€ 58 %

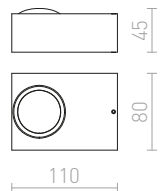





## DIXIE

Apparecchio esterno da parete con CREE LED integrato, in alluminio pressofuso per illuminazione UP/DOWN.

### DIXIE 10x16 DA PARETE

230V LED 2x5W  $\angle 84^\circ$  3000 K 550lm Ra80 IP54

R10352 bianco

€ 68 %

R10353 nero

€ 68 %

R10354 grigio argento

€ 68 %

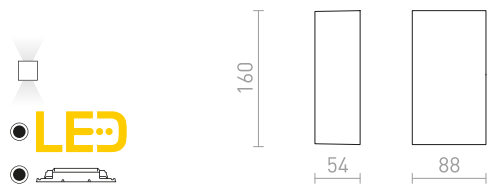

### DIXIE 4x12 DA PARETE

230V/700mA LED 2x3W  $\angle 48^\circ$  3000 K 360lm Ra80 IP54

R10355 nero

€ 98 →

R10356 grigio argento

€ 48 %

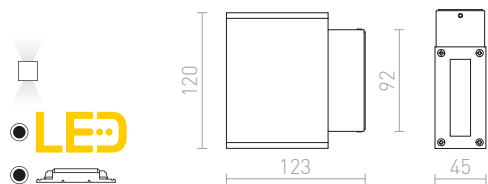

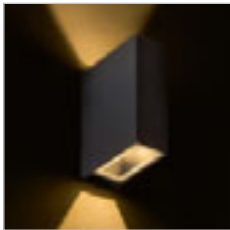

IP54

## UKKO

Appliche quadrata da esterno con LED integrato per illuminazione UP/DOWN.

### UKKO DA PARETE

230 V LED 2x3 W  $\angle 55^\circ$  3000 K 180 lm Ra 80 IP54

R12555 nero

€ 120

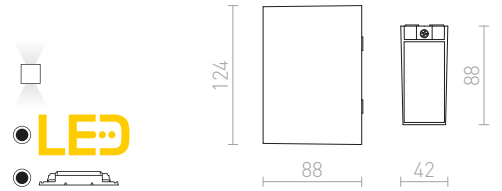

IP54

## PEKKO

Appliche quadrata da esterno con LED integrato per illuminazione unidirezionale.

### PEKKO DA PARETE

230 V LED 3 W  $\angle 67^\circ$  3000 K 86 lm Ra 80 IP54

R12552 bianco

€ 78

R12553 nero

€ 78

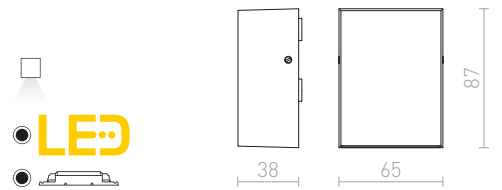

IP54

## NICK

Appliche a LED con illuminazione UP/DOWN per uso esterno ed interno.

### NICK II DA PARETE

230 V LED 2x3 W  $\angle 10^\circ$  3000 K 780 lm Ra 80 IP54

R12827 alluminio spazzolato

€ 68

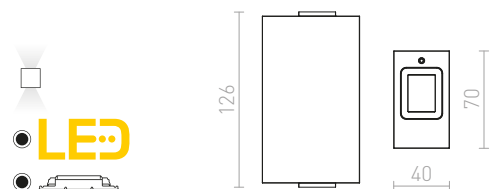



IP54

## ZANE

Applique a tubo piccolo su base quadrata con LED integrato per illuminazione UP/DOWN, adatta per uso esterno.

### ZANE DA PARETE

230 V LED 2x3 W  $\angle 60^\circ$  3000 K 300 lm Ra 80 IP54

R12960 nichel opaco

€ 58 %

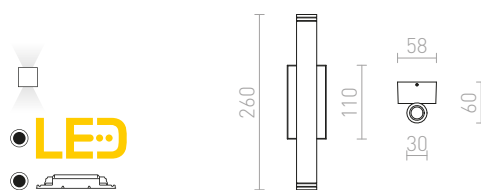

IP54

## MICO

Applique in alluminio pressofuso con riflettore non orientabile, per illuminazione unidirezionale.

### MICO I PARETE

230 V GU10 35 W IP54

R10170 alluminio

€ 58 %

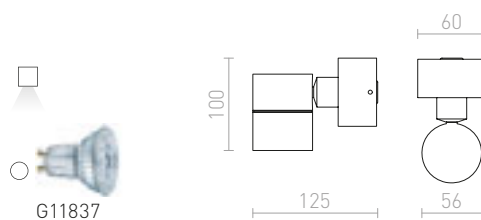

G11837



IP54



IP54

## MOIRE

Lampada da parete in alluminio naturale con coperture di vetro.

### MOIRE I PARETE

230 V GU10 35 W IP54

R10133 alluminio

€ 48 %

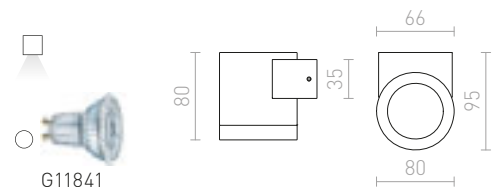

### MOIRE II PARETE

230 V G9 25 W IP54

R10132 alluminio

€ 68 %

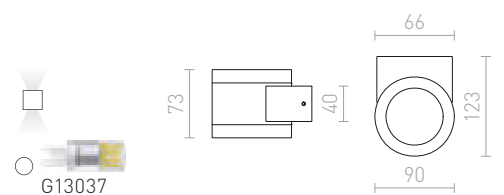

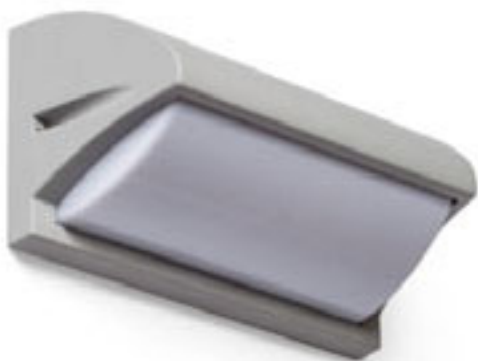

IP54



## MORA

Applique esterna con luce soffusa adatta per terrazze e ingressi di case. Per sorgenti luminose a risparmio energetico E27.

### MORA DA PARETE

230 V E27 18 W IP54

R12571 grigio argento

€ 48

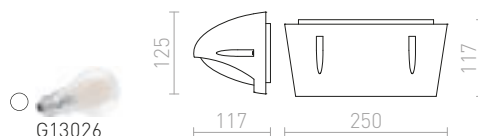

IP54



## LESA

Applique esterna in alluminio pressofuso disponibile in tre colori. Con copertura in metallo per prevenire la diffusione della luce verso l'alto.

### LESA DA PARETE

230 V E27 26 W IP54

R10364 nero

€ 88

R10365 bianco

€ 88

R10366 grigio argento

€ 88

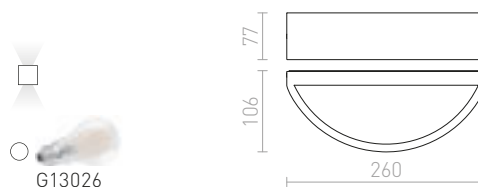





IP54



IP54

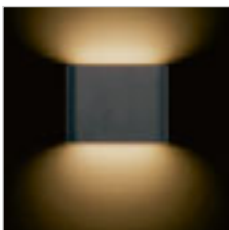

## CHOIX

Applique piatta da esterno UP/DOWN in alluminio pressofuso.

### CHOIX 114 DA PARETE

230 V LED 2x3 W 3000 K 318 lm Ra 80 IP54

R12012 grigio antracite

€ 68



LED

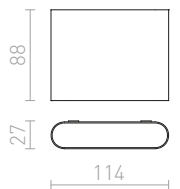

### CHOIX 175 DA PARETE

230 V LED 10 W 3000 K 660 lm Ra 80 IP54

R12691 grigio antracite

€ 78



LED

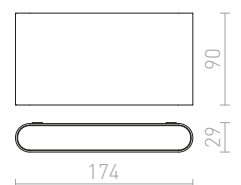



IP65



## FOX

Proiettore a LED orientabile per esterno, con vetro trasparente, montaggio a parete. Per una possibile installazione in giardino, può essere completato con un picchetto (accessorio R11755).

### FOX RIFLETTORE ESTERNO

230 V LED 9 W  $\angle 120^\circ$  3000 K 900 lm Ra 80 IP65

R11753 grigio antracite

€ 178

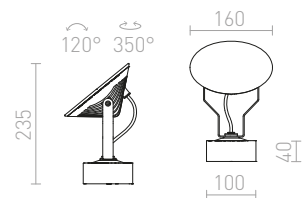

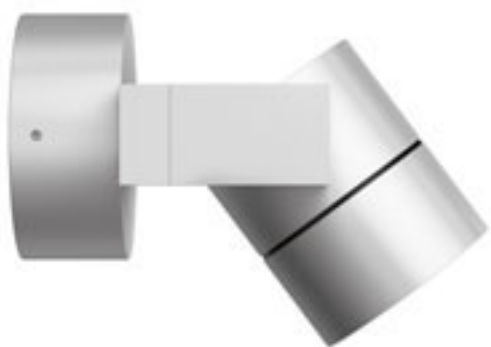

IP44



## ORIT

Faretto da esterno inclinabile in alluminio robusto con LED 6W integrato. Inclinabile solo su un asse.

### ORIT DA PARETE

230 V LED 6 W  $\angle 80^\circ$  3000 K 315 lm Ra 80 IP44

R12033 alluminio

€ 78 ➔

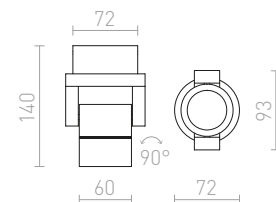

IP54

## DIREZZA

Faretto esterno con un riflettore inclinabile dopo allentamento una vite tra il riflettore e base.

### DIREZZA DA PARETE

230 V GU10 35 W IP54

R10388 grigio argento

€ 58

R10432 grigio antracite

€ 58



G11837

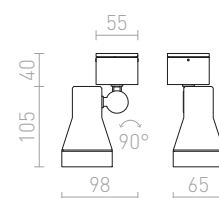







IP54

## BORA

Proiettore quadrato da esterno con LED integrato per montaggio a parete.

### BORA DA PARETE

230 V LED 6 W  $\angle 44^\circ$  3000 K 355 lm Ra 80 IP54

R12578 grigio antracite

€ 98

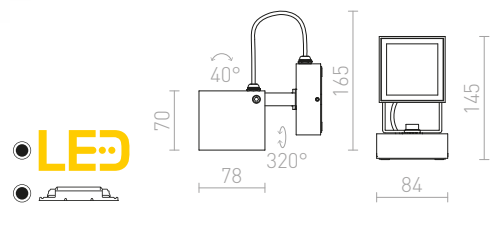

IP54

## PONTA

Proiettore piatto nero ad alta performance con LED integrato e sensore di movimento.

### PONTA RIFLETTORE CON SENSORE

230 V LED 30 W  $\angle 120^\circ$  3000 K 2700 lm Ra 80 IP54

R12982 nero

€ 68

%

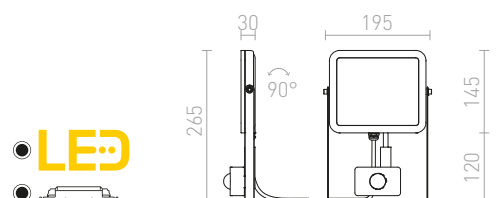





IP65

## BLUESTAR

Proiettore esterno in alluminio con picchetto, compatibile con LED GU10, con cornice frontale in acciaio inossidabile. Fornito con un cavo da 1 m senza presa finale.

### BLUESTAR CON PICCHETTO

230 V GU10 35 W IP65

R13630 grigio antracite

€ 78

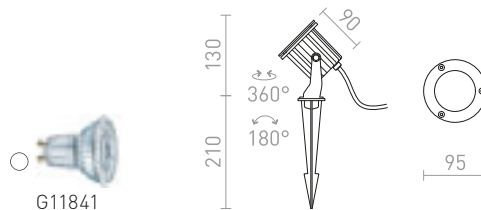

IP65

## GUN

Mini riflettore esterno a LED su picchetto. Fornito con un cavo da 1 m senza presa finale!

### GUN CON PICCHETTO

230 V LED 3x1 W  $\angle 30^\circ$  3000 K 210 lm Ra 80 IP65

R10530 nero

€ 48

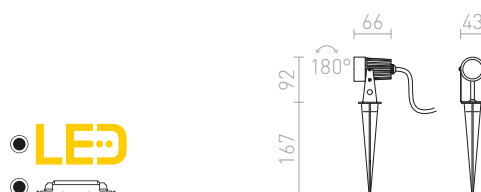



IP54

## DIREZZA

Faretto da esterno con un riflettore inclinabile dopo l'allentamento di una vite tra il riflettore e la base.

### DIREZZA CON PICCHETTO

230 V GU10 35 W IP54

R10427 grigio argento

€ 68

R10431 grigio antracite

€ 68



G11837



IP54

## CORDOBA

Faretto da esterno su picchetto con portalampada GU10. Fornito con cavo da 1m senza presa finale!

### CORDOBA CON PICCHETTO

230 V GU10 35 W IP54

R12579 grigio antracite

€ 68

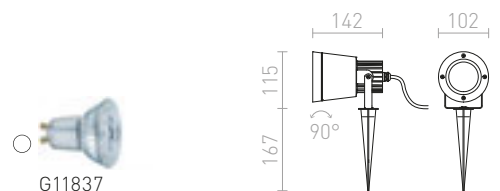

G11837



IP65

## LORCA

Mini faretto a LED da esterno con picchetto da terra.  
Incluso cavo di alimentazione da 1 metro. Cavo fornito  
senza presa finale!

### LORCA CON PICCHETTO

230 V LED 5 W 3000 K 316 lm Ra 80 IP65

R13568 grigio antracite

€ 120

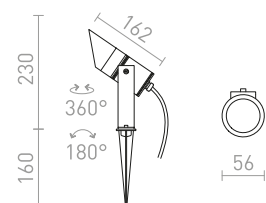



IP65

### GARY

Proiettore LED per esterni su picchetto. Fornito con cavo da 1 m senza presa finale!

#### GARY LED CON PICCHETTO

230 V LED 10 W  $\angle 45^\circ$  3000 K 900 lm Ra 80 IP65

R10527 grigio

€ 88

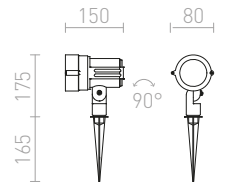

IP54

### BORA

Proiettore quadrato da esterno a diodo LED integrato. Fornito con cavo da 1 m senza presa finale.

#### BORA CON PICCHETTO

230 V LED 6 W  $\angle 50^\circ$  3000 K 340 lm Ra 80 IP54

R12025 grigio antracite

€ 98

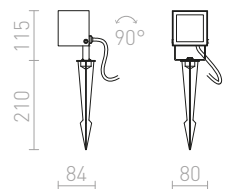

IP65

### COSMO

Proiettore da esterno su picchetto con LED integrato. Fornito con un cavo senza presa finale!

#### COSMO CON PICCHETTO

230 V LED 10 W  $\angle 24^\circ$  3000 K 850 lm Ra 80 IP65

R12580 grigio antracite

€ 98

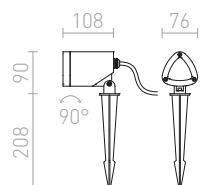



IP65

### HEAVY DUTY

Proiettore da esterno in alluminio robusto. Fornito con cavo senza presa finale! Da combinare con picchetto a terra (accessorio R11755).

#### HEAVY DUTY RIFLETTORE ESTERNO

230 V GU10 50 W IP65

R11948 grigio antracite

€ 68

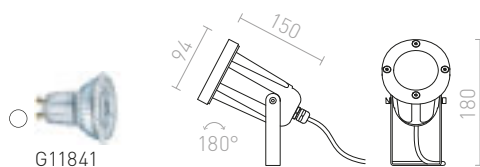

G11841



IP65

### FOX

Proiettore a LED orientabile per esterno, con vetro trasparente, montaggio a parete. Per una possibile installazione in giardino, può essere completato con un picchetto (accessorio R11755).

#### FOX RIFLETTORE ESTERNO

230 V LED 9 W  $\angle 120^\circ$  3000 K 900 lm Ra 80 IP65

R11753 grigio antracite

€ 178

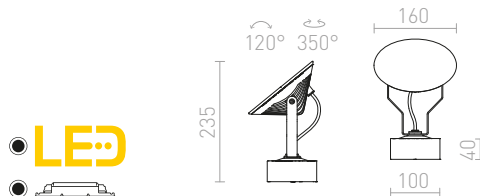

IP65

### ROSS

Proiettore per esterno a LED orientabile con vetro di copertura satinato e scelta d'angolo luminoso di 8-30°. Per installazione in giardino è possibile completarlo con il picchetto a terra (R11755). Fornito senza cavo.

#### ROSS RIFLETTORE ESTERNO

230 V LED 9 W  $\angle 30^\circ$  3000 K 900 lm Ra 80 IP65

R11754 grigio antracite

€ 178

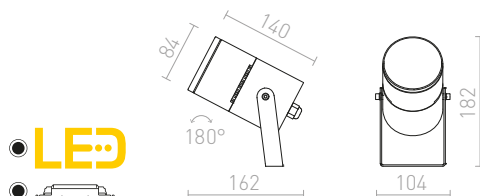





## PICCHETTO

Picchetto universale per apparecchi per esterni. Può essere fissato alle luci con staffa con la filettatura M10 \*1 o con la vite su una console.

**PICCHETTO UNIVERSALE DA TERRA**

R11755 nero

€ 12

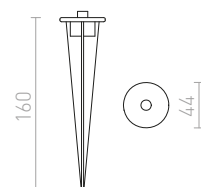



IP67



IP67

## TOPTOP

Apparecchio a LED da terra con le aperture, adatto per il montaggio sulla pavimentazione senza necessità d'incasso.

### TOPTOP S I

230 V LED 1,5 W 3000 K 105 lm Ra 80 IP67

R13617 grigio antracite

€ 88

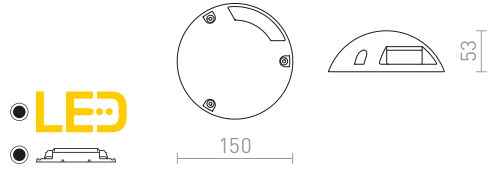

### TOPTOP S III

230 V LED 3x1 W 3000 K 210 lm Ra 80 IP67

R13618 grigio antracite

€ 88

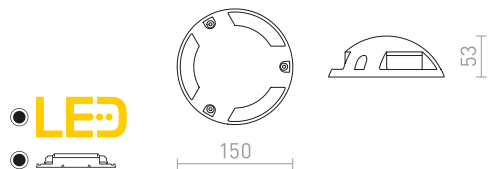



IP54

## FAROS

Apparecchio da esterno a LED integrato con corpo in alluminio pressofuso e illuminazione laterale. Per installazione a parete o a terra.

### FAROS ESTERNO

230 V LED 3 W 3000 K 154 lm Ra 80 IP54

R11963 grigio antracite

€ 120

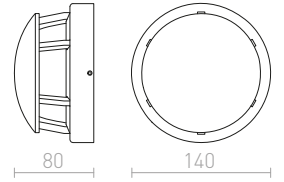

IP67



## TOPTOP

Apparecchio a LED da terra con 4 aperture, adatto per il montaggio sulla pavimentazione senza necessità d'incasso. Se combinato con l'accessorio, picchetto (R11755) è anche possibile installarlo nel giardino.

### TOPTOP IV DA TERRA

230 V LED 4x1 W 3000 K 400 lm Ra 80 IP67

R11751 grigio antracite

€ 158

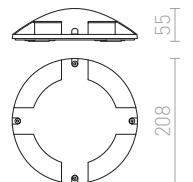

## PICCHETTO

Picchetto universale per apparecchi per esterni. Può essere fissato alle luci con staffa con la filettatura M10 \*1 o con la vite su una console.

### PICCHETTO UNIVERSALE DA TERRA

R11755 nero

€ 12

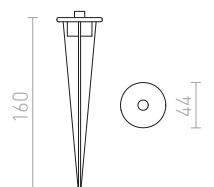





IP65

## BOBO

Luce a LED da esterno in alluminio a plafone per l'illuminazione di orientamento di camminamenti e scale senza necessità d'incasso.

### BOBO R DA PARETE

230 V LED 3 W 3000 K 212 lm Ra 80 IP65

R13933 grigio antracite

€ 48 **NEW**

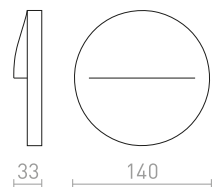
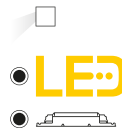



IP65



### BOBO

Luce a LED da esterno in alluminio a plafone per l'illuminazione di orientamento di camminamenti e scale senza necessità d'incasso.

#### BOBO RC DA PARETE

230V LED 8W 3000K 640lm Ra80 IP65

R13934 grigio antracite

€ 58 **NEW**

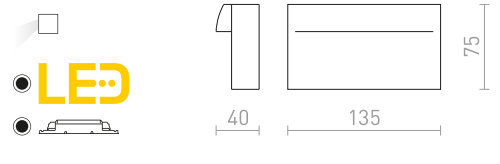

IP65



### BOBO

Luce a LED da esterno in alluminio a plafone per l'illuminazione di orientamento di camminamenti e scale senza necessità d'incasso.

#### BOBO SQ DA PARETE

230V LED 3W 3000K 135lm Ra80 IP65

R13935 grigio antracite

€ 48 **NEW**

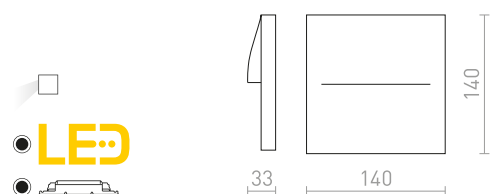





IP65

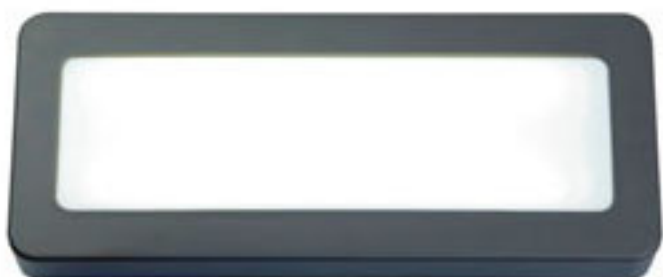

### RENO

Apparecchio esterno da parete realizzato in plastica resistente con LED integrato e driver.

#### RENO SQ DR APPLIQUE/PLAFONIERA

230 V LED 5 W 3000 K 450 lm Ra 80 IP65

R11951 grigio

€ 48 →

R11954 grigio antracite

€ 48 →

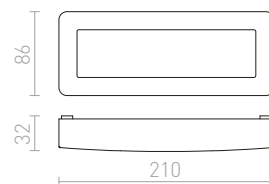

IP65



### RENO

Apparecchio esterno da parete in plastica resistente con LED integrato e driver. Disponibile in due colori. Per illuminazione verso il basso.

#### RENO R DA PARETE

230 V LED 2 W 3000 K 180 lm Ra 80 IP65

R11949 grigio

€ 32 →

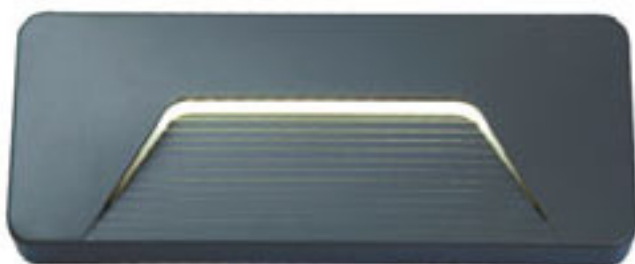
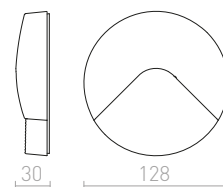
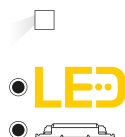

IP65

#### RENO SQ INDR DA PARETE

230 V LED 3 W 3000 K 280 lm Ra 80 IP65

R11950 grigio

€ 38 →

R11953 grigio antracite

€ 38 →

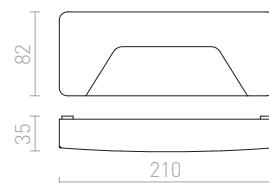
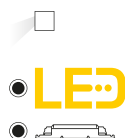





IP54



## ITAKA

Proiettore esterno da parete con inclinazione della luce verso il basso. Adatto per illuminazione di scale e sentieri.

### ITAKA DA PARETE

230 V LED 2 W 3000 K 180 lm Ra 80 IP54

R10379 grigio argento

€ 48 %

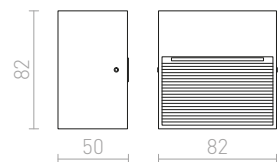
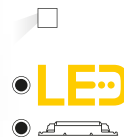



IP54

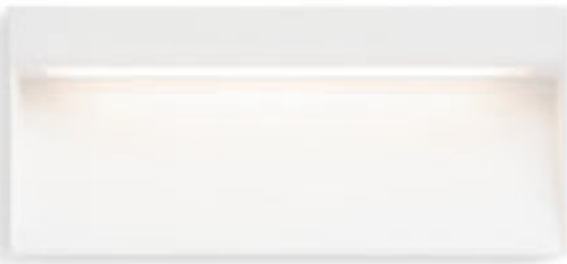

IP54



IP54

## AQILA

Applique con LED integrato per illuminazione di orientamento (illuminazione segnapasso) di marciapiedi, scale o terrazze. Per uso esterno e interno senza necessità d'incasso. Solo luce verso il basso.

### AQILA R DA PARETE

230 V LED 6 W 3000 K 200 lm Ra 80 IP54

R12539 bianco

€ 88

R12540 grigio

€ 78

R12541 grigio antracite

€ 88



LED

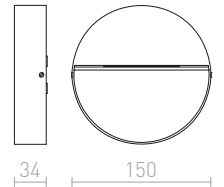

### AQILA RC DA PARETE

230 V LED 6 W 3000 K 200 lm Ra 80 IP54

R12545 bianco

€ 88

R12547 grigio antracite

€ 98



LED

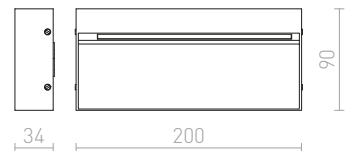

### AQILA SQ DA PARETE

230 V LED 6 W 3000 K 200 lm Ra 80 IP54

R12542 bianco

€ 88

R12544 grigio antracite

€ 88



LED

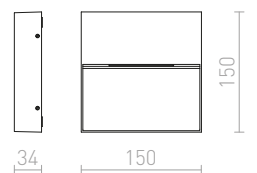









IP54



IP54



IP54

## KICK

Apparecchio di orientamento da incasso con LED integrato, illuminazione verso uno, due o tre lati. Progettato per il montaggio a parete.

### KICK I DA INCASSO

230 V LED 3 W 3000 K 100 lm Ra 80 IP54

R12613 bianco

€ 48

R12615 nero

€ 48

↑ 80  
↻ Ø40

LED

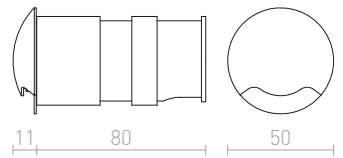
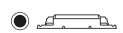

### KICK II DA INCASSO

230 V LED 3 W 3000 K 120 lm Ra 80 IP54

R12616 bianco

€ 48

R12618 nero

€ 48

↑ 80  
↻ Ø40

LED

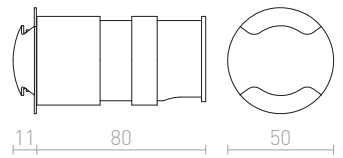
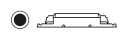

### KICK III DA INCASSO

230 V LED 3 W 3000 K 150 lm Ra 80 IP54

R12619 bianco

€ 48

R12621 nero

€ 48

↑ 80  
↻ Ø40

LED

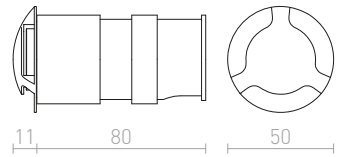



IP54



IP54



IP54



## CLUB

Lampada da incasso a parete con LED integrato adatta per illuminazione direzionale di corridoi e scale.

### CLUB IND DA INCASSO

230 V LED 3 W 3000 K 270 lm Ra 80 IP54

R12686 grigio argento

€ 48

⊥ 90  
● Ø56



● LED

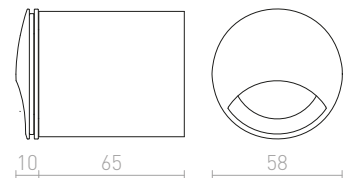
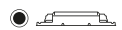

### CLUB DA INCASSO

230 V LED 3 W 3000 K 270 lm Ra 80 IP54

R12685 grigio argento

€ 48

⊥ 90  
● Ø57

● LED

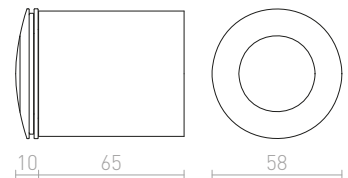

## ELICA

Apparecchio da esterno da incasso a parete con LED integrato e piastra frontale in metallo con orientamento d'illuminazione verso il basso. Scatola di montaggio compresa.

### ELICA R DA INCASSO

230 V LED 3 W 3000 K 75 lm Ra 80 IP54

R12528 alluminio spazzolato

€ 58 %

⊥ 95  
● Ø75



● LED

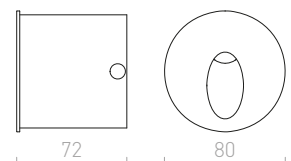



IP54

## MARCO LED

Apparecchio da incasso circolare adatto sia per uso esterno che interno. Solo per illuminazione verso il basso. Scatola di montaggio inclusa.

### MARCO DA INCASSO

230 V LED 3 W 3000 K 80 lm Ra 80 IP54

R12024 bianco

€ 48

R12029 grigio argento

€ 48

R12030 grigio antracite

€ 48

↑ 60  
 ⚙️ Ø76



LED

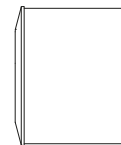

56

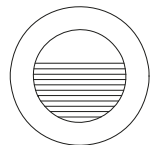

78



IP54



## ASTERIA

Applique da incasso a parete esterna. Montatura visibile con profondità di 3 cm. Da installare solo per illuminazione verso il basso.

### ASTERIA DA INCASSO

230 V LED 3 W 3000 K 180 lm Ra 80 IP54

R10558 grigio argento

€ 58

↑ 75  
 ⚙️ Ø113



LED

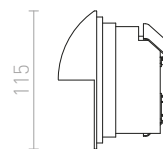

115

32 58

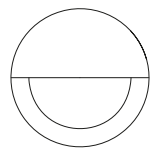

115



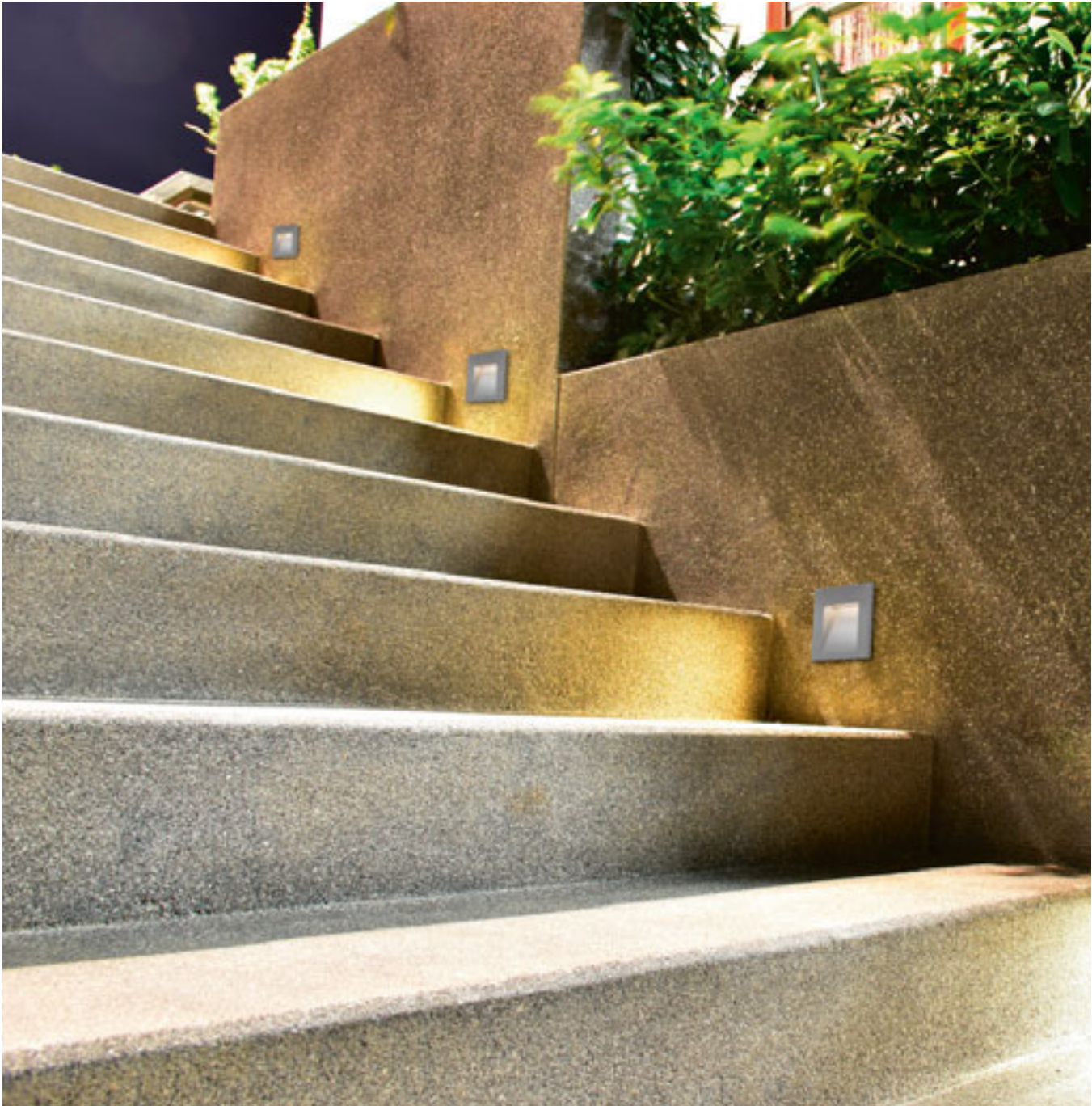

IP54

## TESS

Apparecchio quadrato da incasso a parete per interni ed esterni. Solo per illuminazione verso il basso, disponibile in tre colori. Scatola di montaggio inclusa.

### TESS SQ DA INCASSO

230 V LED 3 W 3000 K 80 lm Ra 80 IP54

**R12013** bianco € 58

**R12014** grigio argento € 58

**R12015** grigio antracite € 58

± 70  
60x55



LED

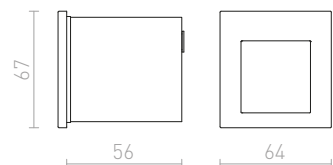



IP65



### RASQ

Lampada da incasso a parete con LED integrato, adatta sia per interni che per esterni. Adatta per l'illuminazione direzionale di sentieri, scale, o terrazze. Illuminazione solo in basso.

#### RASQ DA INCASSO A PARETE

230 V LED 9 W 3000 K 190 lm Ra 80 IP65

R12627 bianco

€ 178

R12628 grigio antracite

€ 178

↑ 80

▣ 237x77



● LED

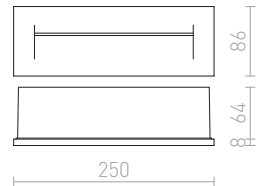

### PER

Applique da incasso a parete con LED integrato. Per uso esterno e interno come illuminazione direzionale di sentieri, scale o terrazze.

#### PER DA INCASSO

230 V LED 3 W 3000 K 76 lm Ra 80 IP54

R12576 bianco

€ 58

R12577 grigio antracite

€ 58

↑ 60

▣ 65x102



● LED

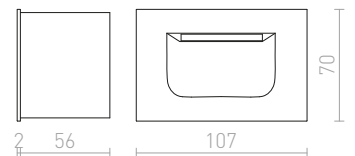

IP54



### ELICA

Apparecchio da esterno da incasso a parete con LED integrato e piastra frontale in metallo con orientamento d'illuminazione verso il basso. Scatola di montaggio compresa.

#### ELICA SQ DA ESTERNO

230 V LED 3 W 3000 K 180 lm Ra 80 IP54

R10639 nichel opaco

€ 35

R12529 alluminio spazzolato

€ 58

↑ 70

⊘ Ø75



● LED

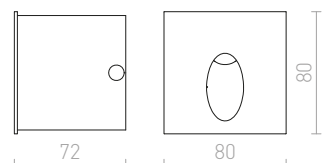

IP54





IP65



IP65



IP65



## GORDIQ

Apparecchio da incasso a parete con LED integrato per illuminazione direzionale di sentieri, scale o terrazze. Luce solo verso il basso.

### GORDIQ S DA INCASSO

230 V LED 1,5 W 3000 K 30 lm Ra 80 IP65

R12533 bianco

€ 58

R12534 grigio antracite

€ 58

↑ 60  
75x72



LED

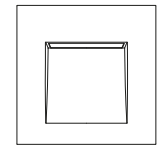
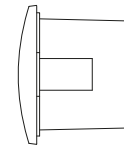

90

### GORDIQ M DA INCASSO

230 V LED 3 W 3000 K 90 lm Ra 80 IP65

R12535 bianco

€ 88

R12536 grigio antracite

€ 88

↑ 60  
115x108



LED

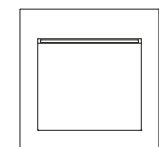
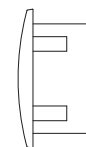
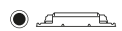

140

### GORDIQ L DA INCASSO

230 V LED 3 W 3000 K 90 lm Ra 80 IP65

R12537 bianco

€ 68

R12538 grigio antracite

€ 68

↑ 60  
115x50



LED

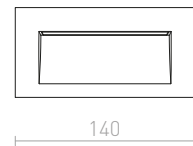
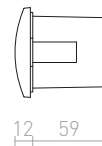

70



IP65

**RAGG**

Apparecchio da incasso da esterno con possibilità di orientare l'illuminazione, adatto per illuminare i marciapiedi o le scale.

**RAGG DA INCASSO**

230V LED 12W 3000K 406lm Ra80 IP65

**R13620** bianco

€ 120

**R13621** nero

€ 120



↑ 80

⚡ 80x230



LED

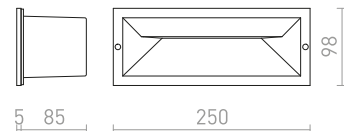





IP65



IP65

## DEJAVU

Apparecchio da incasso a parete con LED integrato. Adatto come illuminazione orientabile per sentieri, scale o terrazze.

### DEJAVU SQ 9 DA INCASSO

230 V LED 3,5 W 3000 K 120 lm Ra 80 IP65

R12530 nero

€ 58 %

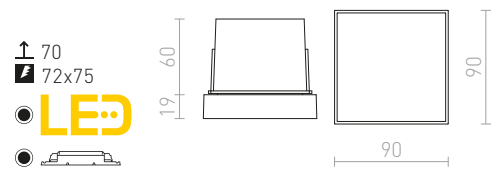

### DEJAVU SQ 14 DA INCASSO

230 V LED 6 W 3000 K 270 lm Ra 80 IP65

R12531 nero

€ 78 %

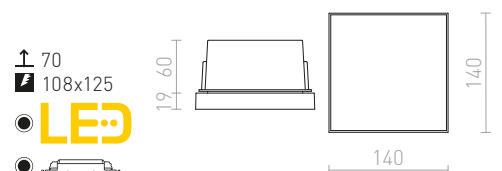



IP54



## SEGNO

Appliche da incasso a parete per ambienti esterni con discreta emissione della luce tramite apertura stretta.

### SEGNO DA INCASSO

230 V LED 3 W 3000 K Ra 80 IP54

R13566 bianco

€ 98

R13567 grigio antracite

€ 98

↑ 70

▣ 172x62



● LED

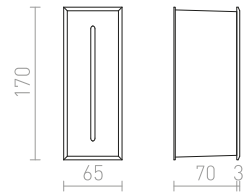

IP54



## FACCA

Apparecchio esterno da incasso a parete. Cornice visibile con profondità di 2 cm. Da installare solo per illuminazione verso il basso.

### FACCA DA INCASSO

230 V LED 2 W 3000 K 130 lm Ra 80 IP54

R10557 grigio argento

€ 48 %

↑ 100

▣ 225x85



● LED

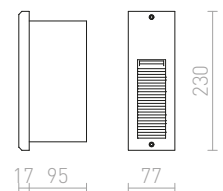





IP54

### GAP

Lampada da incasso a parete in alluminio laccato, adatta sia per uso interno che esterno. Installazione solo per illuminazione verso basso.

#### GAP DA INCASSO

230 V LED 3 W 3000 K 180 lm Ra 80 IP54

R10545 grigio argento

€ 68 %

↑ 55  
 190x45



LED

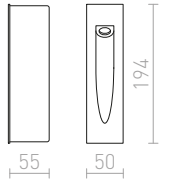

IP65

### AKORD

Applique da incasso a parete, per uso esterno con cornice in acciaio inossidabile e copertura in vetro trasparente. Dimensioni della parte visibile di vetro 11,8/11,5 cm.

#### AKORD DA INCASSO A PARETE

230 V LED 3 W 3000 K 260 lm Ra 80 IP65

R10546 acciaio inossidabile

€ 88 %

↑ 65  
 180x155



LED

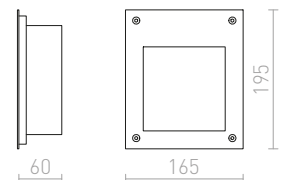



IP67



## ORBU

Apparecchio da incasso esterno in metallo per installazioni a terra.

### ORBU R

230 V GU10 35 W IP67

**R10555** acciaio inossidabile

€ 78

± 105  
 Ø98

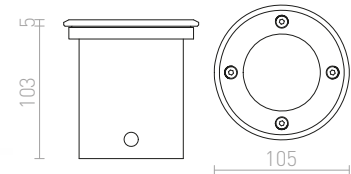

### ORBU SQ 10 DA INCASSO

230 V LED GU10 15 W IP67

**R13439** acciaio inossidabile

€ 78

± 140  
 Ø100

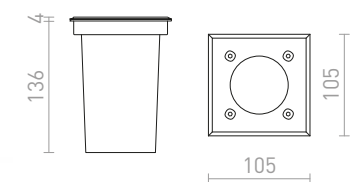



IP65



### NAVY

Faretto robusto da incasso con LED integrato per installazione in controsoffitti esterni.

#### NAVY DA INCASSO

230 V LED 15 W  $\angle 36^\circ$  2700 K 1100 lm Ra 80 IP65

R12661 bianco

€ 120 %

↑ 110  
⊗ Ø125

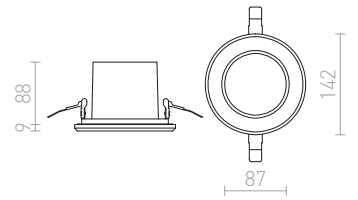
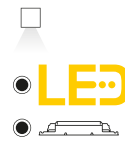

IP65



### TERRA

Apparecchio da esterno da incasso a terra con LED integrato ad alta potenza. Fornito con cavo da 1 m.

#### TERRA DA INCASSO

230 V LED 20 W  $\angle 120^\circ$  3000 K 1450 lm Ra 80 IP65

R10532 acciaio inossidabile

€ 198

↑ 100  
⊗ Ø190

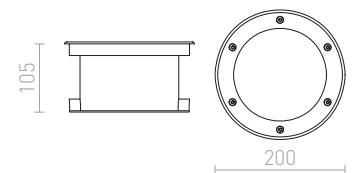
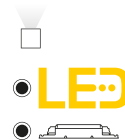

IP65



### RIZZ

Faretto da esterno da incasso, per installazioni a terra con CREE LED integrato. Driver incluso.

#### RIZZ SQ 105

230 V LED 3 W  $\angle 96^\circ$  3000 K 128 lm Ra 80 IP65

R10436 acciaio inossidabile

€ 138

↑ 120  
⊗ Ø90

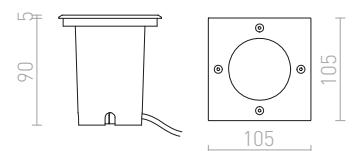
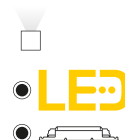





SORGENTI LUMINOSE



# GREEN

# NEW!

NUOVE CATEGORIE DI SORGENTI LUMINOSE LED

## MASSIMA EFFICIENZA ENERGETICA MASSIMA QUALITÀ

Facile sostituzione delle lampadine classiche o alogene con E14, E27, GU10, G9, G53 e altri portalampade.

CONSUMO ENERGETICO MOLTO BASSO

CICLO DI VITA ESTREMAMENTE LUNGO

RAGGIUNGIMENTO DEL 100% DI RESA LUMINOSA INSTANTANEA  
SENZA RITARDO ACCENSIONE

NESSUNA RADIAZIONE UV E BASSA RADIAZIONE INFRAROSSA NEL CONO DI LUCE

MINORE RADIAZIONE DI CALORE RISPETTO AI PRODOTTI STANDARD DI RIFERIMENTO

DESIGN, DIMENSIONI RIDOTTE E FLUSSO LUMINOSO PARAGONABILE A UNA LAMPADINA CLASSICA O ALOGENA



### GLOSSARIO

**RETROFIT** sostituzione diretta di lampadine classiche con lo stesso portalampada E14 o E27.

**Non dimmerabile / ciclo fino a 15.000 ore / fino a 100.000 cicli di acceso-spento / Ra = 80**

**PRO** gamma per uso professionale.

**Dimmerabile / ciclo fino a 45.000 ore / fino a 1.000.000 di cicli acceso-spento / Ra > 90**

**ADV** alta qualità e flessibilità per tutte le applicazioni di dimmeraggio.

**Dimmerabile / ciclo fino a 40.000 ore / fino a 100.000 cicli di acceso-spento / Ra = 80**

**GLOWdim** dimmerazione cambia non solo l'intensità della luce ma anche il colore della luce - da bianco caldo a bianco extra caldo (2700 K-1800 K).

**Dimmerabile / ciclo fino a 25.000 ore / fino a 100.000 cicli di acceso-spento / Ra > 80**

**DIMM** - Dimmerabile con molti dimmer disponibili in commercio.

**Bluetooth** - controllo Bluetooth tramite l'app.

**WIFI** - controllo WIFI tramite l'app.

**Ra (resa cromatica)** - è una valutazione dell'autenticità di percezione del colore prodotta dall'illuminazione di una fonte, rispetto alla quale sarebbe la percezione del colore della luce diurna. Più il numero di Ra si avvicina a 100, minore è la distorsione del colore.



80 Ra

90 Ra

**K (Kelvin)** - la temperatura di cromaticità caratterizza il colore della luce.

1800 K    2700 K    3000 K    4000 K    6500 K    12000 K    16000 K



bianco caldo 1800-2700 K

bianco neutro 3000-3500 K

bianco freddo 4000-4500 K

bianco naturale 5500-6500 K

### Angoli di radiazione

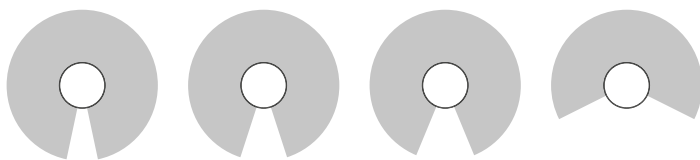

24°

36°

45°

120°

Tutti i parametri tecnici si riferiscono all'intera sorgente luminosa. A causa della complessa procedura durante la produzione dei diodi luminosi, i valori tipici indicate in relazione ai parametri tecnici dei LED solo valori statistici, che non corrispondono necessariamente ai parametri tecnici reali dei prodotti singoli - i prodotti singoli possono presentare deviazioni dai valori tipici.



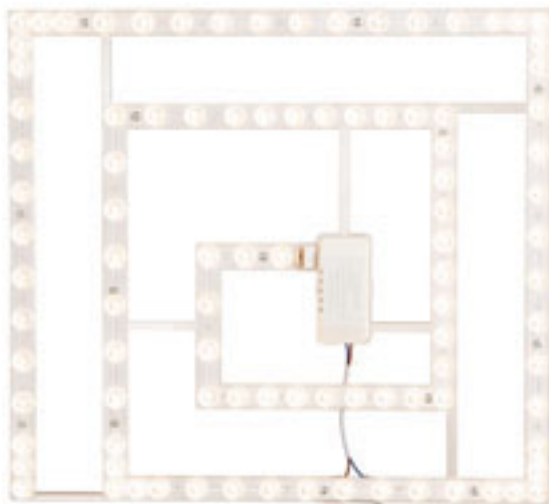

## LED MODUL

Modulo LED di ricambio per un facile utilizzo al posto di sorgenti luminosi esistenti. Il modulo LED viene attaccato alle lampade tramite fissaggi magnetici integrati.

### LED MODUL SQ 10

230 V LED 12 W 3000 K 900 lm Ra 80

G13546

€ 5.50

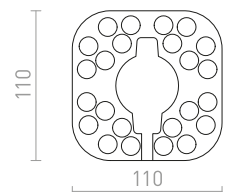
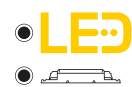

### LED MODUL R 30

230 V LED 36 W 3000 K 2700 lm Ra 80

G13545

€ 14.50

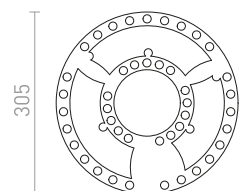
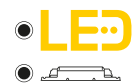

### LED MODUL SQ 41

230 V LED 48 W 3000 K 3600 lm Ra 80

G13547

€ 22

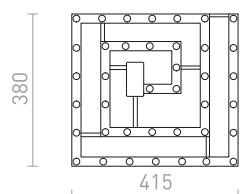



## PARATHOM SMART

Lampadina LED Smart con portalampada E27 controllabile da LEDVANCE SMART+ Android 6.0 o app Apple Homekit. Controllo del colore RGBW. Temperatura regolabile da 2700K a 6500K. Dimmerabile tramite Bluetooth.

### OSRAM SMART+ RGBW CLASSIC A

230 V E27 LED EQ 60 W 2700 K-6500 K 810 lm Ra 80

G13728 opaco

€ 19

Ø60x120 mm

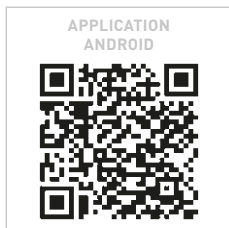

APPLICATION  
ANDROID

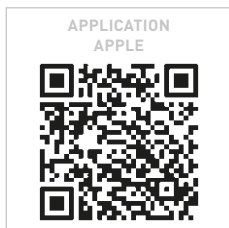

APPLICATION  
APPLE



## PARATHOM SMART

Lampadina LED Smart con portalampada E27 controllabile da LEDVANCE SMART+ Android 6.0 o app Apple Homekit. Dimmerabile tramite Bluetooth.

### OSRAM SMART+ CLASSIC

230 V E27 LED EQ 60 W 2700 K 800 lm Ra 80

G13700 opaco

€ 12

Ø60x120 mm



## PARATHOM RGBW

Lampadina a LED con tecnologia RGB o con illuminazione di colore bianco caldo. Installazione facile senza uso di applicazione o smartphone. Con un semplice tocco di pulsante potete cambiare colori, scene, regolare la loro saturazione ed attenuare l'intensità. Confezione include un telecomando a infrarossi.

### OSRAM RGBW CLASSIC A

230 V E27 LED EQ 60 W 2700 K 806 lm Ra 80

G13579 opaco

€ 16

Ø60x114 mm





### PARATHOM RGBW

Lampadina a LED con tecnologia RGB o con illuminazione di colore bianco caldo. Installazione facile senza uso di applicazione o smartphone. Con un semplice tocco di pulsante potete cambiare colori, scene, regolare la loro saturazione ed attenuare l'intensità. Confezione include un telecomando a infrarossi.

#### OSRAM RGBW PAR16

230 V GU10 LED EQ 25 W 2700 K 250 lm Ra 80

**G13577** bianco

€ 15

Ø50x56 mm



### PARATHOM RGBW

Lampadina a LED con tecnologia RGB o con illuminazione di colore bianco caldo. Installazione facile senza uso di applicazione o smartphone. Con un semplice tocco di pulsante potete cambiare colori, scene, regolare la loro saturazione ed attenuare l'intensità. Confezione include un telecomando a infrarossi.

#### OSRAM RGBW ILUM

230 V E14 LED EQ 40 W 2700 K 470 lm Ra 80

**G13578** opaco

€ 13.50

Ø47x91 mm

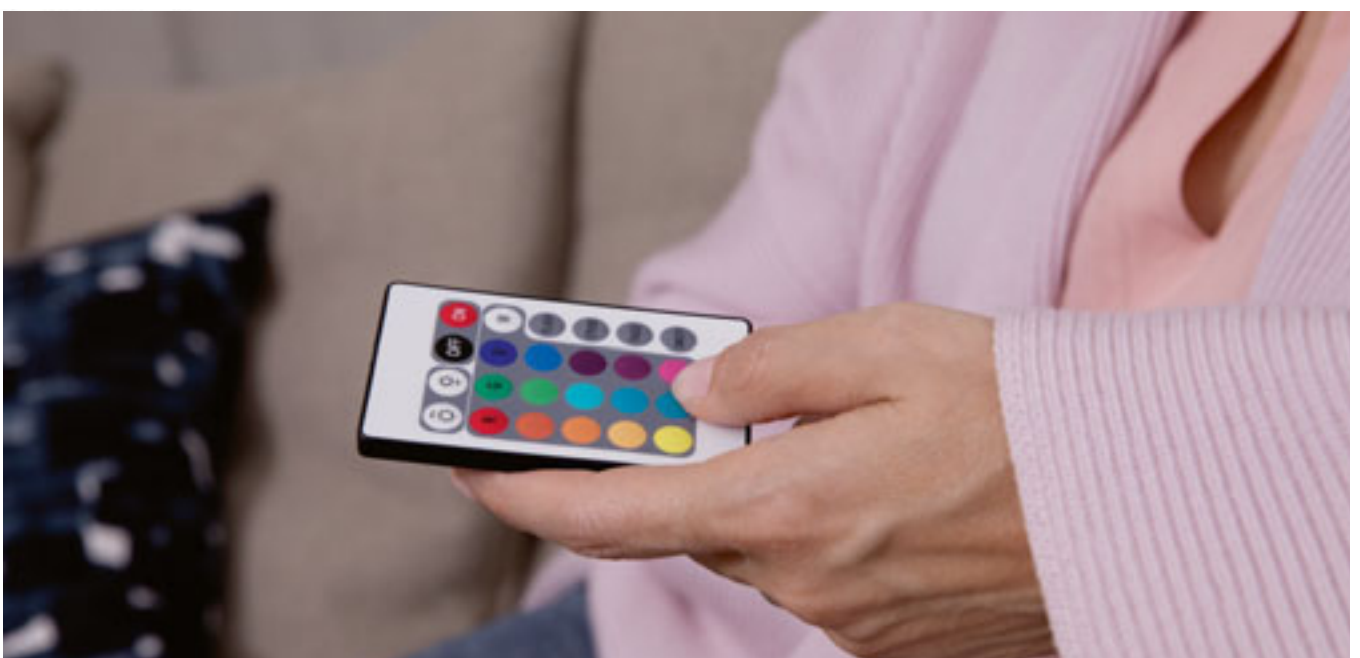



## PARATHOM SMART

Lampadina LED Globe Smart WiFi con attacco E27 dimmerabile tramite l'app: LEDVANCE SMART+ WiFi (con una versione minima di Android 4.4 o iOS 9.0), Google Assistant o Amazon Alexa. Controllo tramite Wi-Fi.

### OSRAM SMART+ GLOBE 125 WIFI

230 V E27 LED EQ 60 W 2700 K 806 lm Ra 80

G13943 chiaro

€ 22

NEW

Ø124x168 mm



### OSRAM SMART+ GLOBE 125 WIFI

230 V E27 LED EQ 60 W 2700 K 806 lm Ra 80

G13944 ambrato

€ 25

NEW

Ø124x168 mm



### OSRAM SMART+ GLOBE 125 WIFI

230 V E27 LED EQ 60 W 2700 K 806 lm Ra 80

G13945 color fumo

€ 25

NEW

Ø124x168 mm







APPLICATION  
ANDROID



APPLICATION  
APPLE



## PARATHOM SMART

Lampadina LED Globe Smart con portalampada E27 controllabile tramite l'app LEDVANCE SMART+ WiFi (con Android 4.4 o iOS 9.0 minimo), Google Assistant o Amazon Alexa. Controllo del colore RGBW. Temperatura di colore della luce bianca regolabile: da 2700K a 6500K. Controllo WiFi.

### OSRAM SMART+ GLOBE 95

230 V E27 LED EQ 100 W RGBW 1521 lm Ra 80

G13833 opaco

€ 38

Ø95x142 mm



WIFI



**OSRAM  
VINTAGE GLOBE 125 DECO**



Ø125x168 mm  
ambrato  
230 V LED E27 EQ 40 W  
2500 K 470 lm Ra 80  
**G13311**

**€ 25**

**OSRAM  
VINTAGE GLOBE 125 SPIRALE**



Ø125x178 mm  
color fumo  
230 V LED E27 EQ 15 W  
1800 K 140 lm Ra 80  
**G13459**

**€ 24**

**OSRAM  
VINTAGE GLOBE 125 SPIRALE**



Ø125x178 mm  
ambrato  
230 V LED E27 EQ 25 W  
2000 K 250 lm Ra 80  
**G13152**

**€ 17**

**OSRAM  
VINTAGE GLOBE 125 DIMM**



Ø125x173 mm  
ambrato dimmerabile  
230 V LED E27 EQ 55 W  
2400 K 650 lm Ra 80  
**G13023**

**€ 18.50**

**OSRAM  
VINTAGE BALLON DIMM**



Ø170x270 mm  
chiaro dimmerabile  
230 V LED E27 EQ 30 W  
2700 K 400 lm Ra 80  
**G13953** NEW

**€ 88**

**OSRAM  
VINTAGE EDISON SPIRALE**



Ø64x140 mm  
color fumo  
230 V LED E27 EQ 25 W  
1800 K 250 lm Ra 80  
**G13581**

**€ 24**

**OSRAM  
VINTAGE EDISON SPIRALE**



Ø64x140 mm  
ambrato  
230 V LED E27 EQ 25 W  
2000 K 250 lm Ra 80  
**G13309**

**€ 14**

**OSRAM  
RETROFIT EDISON**



Ø64x143 mm  
chiaro  
230 V LED E27 EQ 40 W  
2700 K 470 lm Ra 80  
**G13573**

**€ 11.50**

**OSRAM  
VINTAGE**



Ø75x156 mm  
ambrato  
230 V LED E27 EQ 40 W  
2500 K 470 lm Ra 80  
**G13310**

**€ 24**

**OSRAM  
RETROFIT TUBE**



Ø25x80 mm  
chiaro  
230 V LED E14 EQ 40 W  
2700 K 470 lm Ra 80  
**G13150**

**€ 9.20**

**OSRAM  
VINTAGE TUB**



Ø28.5x138 mm  
ambrato  
230 V LED E27 EQ 20 W  
2400 K 200 lm Ra 80  
**G13021**

**€ 13**

**OSRAM  
VINTAGE TUB**



Ø28.5x204 mm  
ambrato  
230 V LED E27 EQ 35 W  
2400 K 400 lm Ra 80  
**G13022**

**€ 17**

**OSRAM  
VINTAGE CANDELA**



Ø35x100 mm  
ambrato  
230 V LED E14 EQ 35 W  
2400 K 410 lm Ra 80  
**G13308**

**€ 8.35**

**OSRAM  
TOP ILUM**



Ø45x78 mm  
cromo  
230 V LED E14 EQ 31 W  
2700 K  $\angle 320^\circ$  380 lm Ra 80  
**G13013**

**€ 9**

**OSRAM  
TOP CLASSIC A**



Ø60x105 mm  
cromo  
230 V LED E27 EQ 50 W  
2700 K 650 lm Ra 80  
**G13154**

**€ 11**

**OSRAM  
TOP CLASSIC A**



Ø60x105 mm  
lamina d'oro  
230 V LED E27 EQ 50 W  
2700 K 650 lm Ra 80  
**G13458**

**€ 7.80**

**OSRAM  
RETROFIT GLOBE 125**



Ø124x168 mm  
chiaro  
230 V LED E27 EQ 25 W  
2700 K 250 lm Ra 80  
**G12244** € 9.80

**OSRAM  
RETROFIT GLOBE 125**



Ø124x168 mm  
chiaro  
230 V LED E27 EQ 40 W  
2700 K 470 lm Ra 80  
**G12245** € 11.50

**OSRAM  
RETROFIT GLOBE 125**



Ø124x168 mm  
chiaro  
230 V LED E27 EQ 60 W  
2700 K 806 lm Ra 80  
**G12246** € 14.50

**OSRAM  
RETROFIT GLOBE 125**



Ø124x168 mm  
opaco  
230 V LED E27 EQ 100 W  
2700 K 1521 lm Ra 80  
**G13460** € 24

**OSRAM  
RETROFIT GLOBE 95**



Ø95x138 mm  
opaco  
230 V LED E27 EQ 60 W  
2700 K 806 lm Ra 80  
**G13024** € 10.50

**OSRAM  
RETROFIT GLOBE 95 DIMM**



Ø95x135 mm  
vetro opalino dimmerabile  
230 V LED E27 EQ 75 W  
2700 K 1055 lm Ra 80  
**G13462** € 15.50

**OSRAM  
RETROFIT GLOBE 95 DIMM**



Ø95x135 mm  
vetro opalino dimmerabile  
230 V LED E27 EQ 100 W  
2700 K 1521 lm Ra 80  
**G13461** € 22

**OSRAM  
ULTRA ECONOMY  
210LM/W GLOBE 95**



Ø95x140 mm **A**  
chiaro  
230 V LED E27 EQ 60 W  
3000 K 840 lm Ra 80  
**G13951** **NEW** € 24

**OSRAM  
ULTRA ECONOMY  
210LM/W GLOBE 95**



Ø95x140 mm **A**  
opaco  
230 V LED E27 EQ 60 W  
3000 K 840 lm Ra 80  
**G13952** **NEW** € 24

**LAMBRINA  
230**



Ø230x80 mm  
opaco  
230 V LED E27 36 W  
3000 K 2200 lm Ra 80  
**G13518** **NEW** € 15.50

**OSRAM  
ULTRA ECONOMY  
210LM/W CLASSIC A**



Ø60x105 mm **A**  
chiaro  
230 V LED E27 EQ 60 W  
3000 K 840 lm Ra 80  
**G13947** **NEW** € 22

**OSRAM  
ULTRA ECONOMY  
210LM/W CLASSIC A**



Ø60x105 mm **A**  
chiaro  
230 V LED E27 EQ 100 W  
3000 K 1521 lm Ra 80  
**G13948** **NEW** € 28

**OSRAM  
ULTRA ECONOMY  
210LM/W CLASSIC A**



Ø60x105 mm **A**  
opaco  
230 V LED E27 EQ 60 W  
3000 K 840 lm Ra 80  
**G13949** **NEW** € 22

**OSRAM  
ULTRA ECONOMY  
210LM/W CLASSIC A**



Ø60x105 mm **A**  
opaco  
230 V LED E27 EQ 100 W  
3000 K 1521 lm Ra 80  
**G13950** **NEW** € 28

**OSRAM  
RETROFIT CANDELA**



Ø35x100 mm  
chiaro  
230 V LED E14 EQ 40 W  
2700 K 470 lm Ra 80  
**G11849**

**€ 5.35**

**OSRAM  
RETROFIT CANDELA**



Ø35x100 mm  
chiaro  
230 V LED E14 EQ 40 W  
4000 K 470 lm Ra 80  
**G13455**

**€ 5.35**

**OSRAM  
RETROFIT CANDELA**



Ø35x100 mm  
chiaro  
230 V LED E14 EQ 60 W  
2700 K 806 lm Ra 80  
**G13725**

**€ 8.25**

**OSRAM  
RETROFIT CANDELA**



Ø35x100 mm  
opaco  
230 V LED E14 EQ 25 W  
2700 K 250 lm Ra 80  
**G13946** NEW

**€ 4.80**

**OSRAM  
RETROFIT CANDELA DIMM**



Ø35x97 mm  
opaco dimmerabile  
230 V LED E14 EQ 40 W  
2700 K 470 lm Ra 80  
**G13151**

**€ 7.80**

**OSRAM  
RETROFIT CANDELA DIMM**



Ø35x100 mm  
opaco dimmerabile  
230 V LED E14 EQ 60 W  
2700 K 806 lm Ra 80  
**G13454**

**€ 11.50**

**OSRAM  
RETROFIT ILUM DIMM**



Ø45x78 mm  
opaco dimmerabile  
230 V LED E14 EQ 25 W  
2700 K 250 lm Ra 80  
**G13847** NEW

**€ 7.80**

**OSRAM  
RETROFIT ILUM**



Ø45x78 mm  
chiaro  
230 V LED E14 EQ 40 W  
2700 K 470 lm Ra 80  
**G12243**

**€ 5.80**

**OSRAM  
RETROFIT ILUM DIMM**



Ø45x78 mm  
chiaro dimmerabile  
230 V LED E14 EQ 60 W  
2700 K 806 lm Ra 80  
**G13572**

**€ 8.80**

**OSRAM  
RETROFIT ILUM**



Ø45x77 mm  
opaco  
230 V LED E14 EQ 40 W  
2700 K 470 lm Ra 80  
**G13098**

**€ 5.50**

**OSRAM  
RETROFIT ILUM DIMM**



Ø45x78 mm  
opaco dimmerabile  
230 V LED E14 EQ 60 W  
2700 K 806 lm Ra 80  
**G13453**

**€ 11.50**

**OSRAM  
RETROFIT ILUM DIMM**



Ø45x77 mm  
chiaro dimmerabile  
230 V LED E27 EQ 40 W  
2700 K 470 lm Ra 80  
**G13014**

**€ 8.25**

**OSRAM  
RETROFIT ILUM**



Ø45x77 mm  
chiaro  
230 V LED E27 EQ 60 W  
2700 K 806 lm Ra 80  
**G13307**

**€ 8.80**

**OSRAM  
RETROFIT ILUM DIMM**



Ø45x77 mm  
opaco dimmerabile  
230 V LED E27 EQ 25 W  
2700 K 250 lm Ra 80  
**G13119**

**€ 7.80**

**OSRAM  
RETROFIT ILUM DIMM**



Ø45x77 mm  
opaco dimmerabile  
230 V LED E27 EQ 40 W  
2700 K 470 lm Ra 80  
**G13015**

**€ 8.50**

**OSRAM  
RETROFIT CLASSIC A DIMM**



Ø60x105 mm  
chiaro dimmerabile  
230 V LED E27 EQ 40 W  
2700 K 470 lm Ra 80  
**G13110** € 7.35

**OSRAM  
RETROFIT CLASSIC A DIMM**



Ø60x105 mm  
chiaro dimmerabile  
230 V LED E27 EQ 60 W  
2700 K 806 lm Ra 80  
**G13111** € 7.35

**OSRAM  
RETROFIT CLASSIC A DIMM**



Ø60x105 mm  
chiaro dimmerabile  
230 V LED E27 EQ 75 W  
2700 K 1055 lm Ra 80  
**G13112** € 11

**OSRAM  
RETROFIT CLASSIC A DIMM**



Ø60x105 mm  
chiaro dimmerabile  
230 V LED E27 EQ 100 W  
2700 K 1521 lm Ra 80  
**G13123** € 14.50

**OSRAM  
RETROFIT CLASSIC A DIMM**



Ø60x105 mm  
opaco dimmerabile  
230 V LED E27 EQ 40 W  
2700 K 470 lm Ra 80  
**G13099** € 8.35

**OSRAM  
RETROFIT CLASSIC A DIMM**



Ø60x106 mm  
opaco dimmerabile  
230 V LED E27 EQ 60 W  
2700 K 806 lm Ra 80  
**G13026** € 8.35

**OSRAM  
RETROFIT CLASSIC A DIMM**



Ø60x105 mm  
opaco dimmerabile  
230 V LED E27 EQ 60 W  
4000 K 806 lm Ra 80  
**G13027** € 8.35

**OSRAM  
RETROFIT CLASSIC A DIMM**



Ø60x105 mm  
opaco dimmerabile  
230 V LED E27 EQ 75 W  
2700 K 1055 lm Ra 80  
**G13028** € 12

**OSRAM  
RETROFIT CLASSIC A DIMM**



Ø60x105 mm  
opaco dimmerabile  
230 V LED E27 EQ 75 W  
4000 K 1055 lm Ra 80  
**G13477** € 12

**OSRAM  
RETROFIT CLASSIC A**



Ø60x105 mm  
opaco  
230 V LED E27 EQ 100 W  
2700 K 1521 lm Ra 80  
**G13029** € 12

**OSRAM  
RETROFIT CLASSIC A DIMM**



Ø60x105 mm  
opaco dimmerabile  
230 V LED E27 EQ 100 W  
2700 K 1521 lm Ra 80  
**G13306** € 14.50

**OSRAM  
RETROFIT CLASSIC A**



Ø70x118 mm  
opaco  
230 V LED E27 EQ 150 W  
2700 K 2452 lm Ra 80  
**G13457** € 24

**OSRAM  
ADV CLASSIC A DIMM**



Ø67x143 mm  
opaco dimmerabile  
230 V LED E27 EQ 150 W  
2700 K <200° 2452 lm Ra 80  
**G12237** € 24

**OSRAM  
RETROFIT CLASSIC A**



Ø95x162 mm  
opaco  
230 V LED E27 EQ 200 W  
2700 K 3452 lm Ra 80  
**G13831** € 35

**OSRAM  
RETROFIT CLASSIC A DIMM**



Ø90x184 mm  
opaco dimmerabile  
230 V LED E27 EQ 200 W  
2700 K 3452 lm Ra 80  
**G13832** € 35



**LED E27  
TUBE**



Ø50x100 mm  
230 V LED E27 7,5 W  
3000 K ∠180° 700 lm Ra 80  
**G12985** ➔ **€ 3.80**

**OSRAM  
TUBE**



Ø36x116 mm  
opaco  
230 V LED E27 EQ 75 W  
2700 K 1050 lm Ra 80  
**G13155** **€ 7.80**

**OSRAM  
PIN MICRO G4**



Ø10x30 mm  
12 V LED G4 EQ 10 W  
2700 K ∠300° 100 lm Ra 80  
**G13828** **€ 11**

**OSRAM  
PIN G4**



Ø13x36 mm  
12 V LED G4 EQ 20 W  
2700 K ∠300° 200 lm Ra 80  
**G13034** **€ 7.35**

**OSRAM  
PIN G4**



Ø14x40 mm  
12 V LED G4 EQ 30 W  
2700 K ∠320° 300 lm Ra 80  
**G13035** **€ 8.80**

**OSRAM  
PIN G9**



Ø16x60 mm  
vetro trasparente  
230 V LED G9 EQ 30 W  
2700 K ∠320° 300 lm Ra 80  
**G13478** ➔ **€ 11**

**OSRAM  
PIN G9**



Ø15x46 mm  
230 V LED G9 EQ 20 W  
2700 K 200 lm Ra 80  
**G13715** **€ 6.80**

**OSRAM  
PIN G9**



Ø15x47 mm  
230 V LED G9 EQ 30 W  
2700 K ∠300° 320 lm Ra 80  
**G13036** **€ 8.80**

**OSRAM  
PIN G9 DIMM**



Ø16x52 mm  
dimmerabile  
230 V LED G9 EQ 30 W  
2700 K 320 lm Ra 80  
**G13829** **€ 17**

**OSRAM  
PIN G9**



Ø19x52 mm  
230 V LED G9 EQ 40 W  
2700 K ∠300° 470 lm Ra 80  
**G13037** **€ 12**

**OSRAM  
PIN G9**



Ø19x52 mm  
230 V LED G9 EQ 40 W  
4000 K ∠300° 470 lm Ra 80  
**G13038** **€ 12**

**OSRAM  
PIN G9 DIMM**



Ø18x59 mm  
dimmerabile  
230 V LED G9 EQ 40 W  
2700 K 470 lm Ra 80  
**G13830** **€ 22**

**OSRAM  
PIN G9**



Ø18x59 mm  
230 V LED G9 EQ 50 W  
2700 K ∠320° 600 lm Ra 80  
**G13464** **€ 17**

**OSRAM  
SPECIAL SLIM**



Ø18x90 mm  
chiaro  
230 V LED B15d EQ 60 W  
2700 K ∠320° 806 lm Ra 80

**G13456 € 38**

**OSRAM  
SPECIAL SLIM DIMM**



Ø18x100 mm  
chiaro dimmerabile  
230 V LED B15D EQ 75 W  
2700 K 1055 lm Ra 80

**G13574 € 48**

**OSRAM  
SLIM LINE 118MM**



Ø20x118 mm  
chiaro  
230 V LED R7S EQ 100 W  
2700 K 1521 lm Ra 80

**G13576 € 24**

**OSRAM  
LINE 118MM DIMM**



Ø28x118 mm  
dimmerabile  
230 V LED R7S EQ 125 W  
2700 K ∠300° 2000 lm Ra 80

**G13044 € 38**

**OSRAM  
LINE 118MM DIMM**



Ø28x118 mm  
chiaro dimmerabile  
230 V LED R7s EQ 150 W  
2700 K 2452 lm Ra 80

**G13468 € 58**

**OSRAM  
SLIM LINE 78MM**



Ø20x78 mm  
chiaro  
230 V LED R7S EQ 60 W  
2700 K ∠300° 806 lm Ra 80

**G13575 € 16.50**

**OSRAM  
LINE 78MM DIMM**

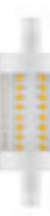

Ø29x78 mm  
dimmerabile  
230 V LED R7S EQ 75 W  
2700 K ∠300° 1055 lm Ra 80

**G13043 € 18**

**OSRAM  
LINE 78MM DIMM**

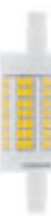

Ø28x78 mm  
chiaro dimmerabile  
230 V LED R7s EQ 100 W  
2700 K 1521 lm Ra 80

**G13467 € 32**

**OSRAM  
HALO PIN G9**



Ø14x43 mm  
chiaro dimmerabile  
230 V G9 EQ 25 W  
2700 K 235 lm Ra 100

**G13122 € 5**

**OSRAM  
HALO PIN G9**



Ø14x43 mm  
chiaro dimmerabile  
230 V G9 EQ 40 W  
2700 K 460 lm Ra 100

**G13045 € 5**

**OSRAM  
HALO LINE 78MM**



Ø12x78 mm  
chiaro dimmerabile  
230 V R7S EQ 60 W  
2900 K 750 lm Ra 100

**G13047 € 9**

**OSRAM  
MR16 DIMM**



Ø50x44 mm  
dimmerabile  
12 V LED GU5,3 EQ 35 W  
3000 K ∠36° 345 lm Ra 90

**G13960** **NEW** € 12

**OSRAM  
PRO MR16 DIMM**



Ø51x46 mm  
dimmerabile  
12 V LED GU5,3 EQ 20 W  
3000 K ∠36° 230 lm Ra 97

**G12234** € 11

**OSRAM  
MR16 DIMM**



Ø50x44 mm  
dimmerabile  
12 V LED GU5,3 EQ 50 W  
3000 K ∠36° 621 lm Ra 90

**G13705** € 17.50

**OSRAM  
PAR16 DIMM**



Ø51x55 mm  
dimmerabile  
230 V LED GU10 EQ 35 W  
2700 K ∠36° 230 lm Ra 90

**G13120** € 7.80

**OSRAM  
ADV PAR16 DIMM**



Ø51x55 mm  
dimmerabile  
230 V LED GU10 EQ 35 W  
3000 K ∠36° 230 lm Ra 90

**G11837** € 7.80

**OSRAM  
ADV PAR16 DIMM**



Ø50x52 mm  
dimmerabile  
230 V LED GU10 EQ 35 W  
4000 K ∠36° 230 lm Ra 90

**G12206** € 7.80

**OSRAM  
PRO PAR16 DIMM**



Ø51x55 mm  
dimmerabile  
230 V LED GU10 EQ 35 W  
3000 K ∠36° 230 lm Ra 97

**G11852** € 10.50

**OSRAM  
ADV PAR16 DIMM**



Ø50x52 mm  
dimmerabile  
230 V LED GU10 EQ 50 W  
2700 K ∠36° 350 lm Ra 90

**G11840** € 8.35

**OSRAM  
ADV PAR16 DIMM**



Ø51x55 mm  
dimmerabile  
230 V LED GU10 EQ 50 W  
3000 K ∠36° 350 lm Ra 90

**G11841** € 8.35

**OSRAM  
ADV PAR16 DIMM**



Ø50x52 mm  
dimmerabile  
230 V LED GU10 EQ 50 W  
4000 K ∠36° 350 lm Ra 90

**G12207** € 8.35

**OSRAM  
PAR16**



Ø51x55 mm  
230 V LED GU10 EQ 50 W  
2700 K ∠120° 350 lm Ra 80

**G12232** € 6

**OSRAM  
ADV PAR16 DIMM**



Ø50x52 mm  
dimmerabile  
230 V LED GU10 EQ 80 W  
3000 K ∠36° 550 lm Ra 90

**G12065** € 13

**OSRAM  
PAR16 DIMM**



Ø51x54 mm  
dimmerabile  
230 V LED GU10 EQ 80 W  
4000 K ∠36° 575 lm Ra 90

**G13041** € 13

**OSRAM  
PAR16 DIMM**



Ø50x52 mm  
dimmerabile  
230 V LED GU10 EQ 80 W  
2700 K ∠120° 575 lm Ra 90

**G13040** € 13

**OSRAM  
PAR16 DIMM**



Ø50x52 mm  
dimmerabile  
230 V LED GU10 EQ 100 W  
3000 K ∠36° 750 lm Ra 80

**G13706** € 19

**OSRAM  
PAR16**



Ø50x53 mm  
bianco  
230 V LED GU10 EQ 35 W  
2700 K ∠36° 230 lm Ra 80  
**G13465 € 4.35**

**OSRAM  
PAR16**



Ø50x53 mm  
bianco  
230 V LED GU10 EQ 50 W  
2700 K ∠36° 350 lm Ra 80  
**G13466 € 6**

**ALFA  
69**



Ø69x70 mm  
grigio argento/cromo  
230 V LED GU10 6 W  
3000 K ∠24° 300 lm Ra 80  
**G13406 € 11**

**ALFA  
69**



Ø69x70 mm  
grigio argento/cromo  
230 V LED GU10 6 W  
4000 K ∠24° 300 lm Ra 80  
**G13407 € 11**

**OSRAM  
PRO AR111 DIMM**



Ø111x62 mm  
dimmerabile  
12 V LED G53 EQ 50 W  
3000 K ∠24° 450 lm Ra 90  
**G13722 € 48**

**OSRAM  
PRO AR111 DIMM**



Ø111x62 mm  
dimmerabile  
12 V LED G53 EQ 100 W  
2700 K ∠24° 950 lm Ra 90  
**G13723 € 58**

**OSRAM  
PRO AR111 DIMM**



Ø107x55 mm  
dimmerabile  
12 V LED G53 EQ 75 W  
4000 K ∠24° 800 lm Ra 97  
**G13724 € 48**

**OSRAM  
PRO AR111 DIMM**



Ø111x62 mm  
dimmerabile  
12 V LED G53 EQ 50 W  
3000 K ∠40° 450 lm Ra 97  
**G13655 € 48**

**OSRAM  
PRO AR111 DIMM**



Ø111x62 mm  
dimmerabile  
12 V LED G53 EQ 75 W  
3000 K ∠40° 800 lm Ra 97  
**G13656 € 48**

**OSRAM  
PRO AR111 DIMM**



Ø111x62 mm  
dimmerabile  
12 V LED G53 EQ 75 W  
3000 K ∠24° 800 lm Ra 97  
**G13657 € 48**

**LED  
ES111**



Ø111x70 mm  
bianco  
230 V LED GU10 12 W  
3000 K ∠45° 1000 lm Ra 80  
**G12723 € 12**

**LED  
ES111**



Ø111x70 mm  
grigio  
230 V LED GU10 12 W  
3000 K ∠45° 1000 lm Ra 80  
**G12724 € 12**

**LED  
ES111**



Ø111x70 mm  
bianco  
230 V LED GU10 12 W  
4000 K ∠45° 1000 lm Ra 80  
**G12725 € 12**

**LED  
ES111**



Ø111x70 mm  
grigio  
230 V LED GU10 12 W  
4000 K ∠45° 1000 lm Ra 80  
**G12726 € 12**

**OSRAM  
R50 DIMM**



Ø50x85 mm  
dimmerabile  
230 V LED E14 EQ 60 W  
2700 K ∠36° 345 lm Ra 90

**G13147 € 11.50**

**OSRAM  
R63 DIMM**



Ø63x105 mm  
dimmerabile  
230 V LED E27 EQ 60 W  
2700 K ∠36° 345 lm Ra 90

**G13148 € 14**

**OSRAM  
R80 DIMM**



Ø80x115 mm  
dimmerabile  
230 V LED E27 EQ 100 W  
2700 K ∠36° 670 lm Ra 80

**G13149 € 18**

**OSRAM  
PAR20 DIMM**



Ø65x85 mm  
dimmerabile  
230 V LED E27 EQ 50 W  
2700 K ∠36° 345 lm Ra 90

**G13020 € 12**

**OSRAM  
ADV PAR30 DIMM**



Ø95x93 mm  
dimmerabile  
230 V LED E27 EQ 75 W  
2700 K ∠36° 633 lm Ra 90

**G12067 € 22**

**OSRAM  
ADV PAR38 DIMM**



Ø120x132 mm  
dimmerabile  
230 V LED E27 EQ 120 W  
2700 K ∠30° 1035 lm Ra 80

**G12068 € 32**



**OSRAM  
PAR16 GLOWDIM**



Ø50x54 mm  
dimmerabile  
230 LED GU10 EQ 50 W  
2700 K ∠36° 350 lm Ra 80

**G13185 € 11.50**

**OSRAM  
ADV CANDELA GLOWDIM**



Ø38x105 mm  
opaco dimmerabile  
230 V LED E14 EQ 40 W  
2700 K 470 lm Ra 80

**G12209 % € 8.50**



**OSRAM LEDINESTRA  
1P 30 DIMM**

Ø300 mm  
opaco dimmerabile  
230 V LED S14d EQ 27 W  
2700 K 275 lm Ra 80  
**G11860** € 38

**OSRAM LEDINESTRA  
1P 50 DIMM**

Ø500 mm  
opaco dimmerabile  
230 V LED S14d EQ 40 W  
2700 K 470 lm Ra 80  
**G11862** € 48

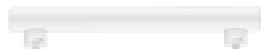
**OSRAM LEDINESTRA  
2P 30 DIMM**

Ø300 mm  
opaco dimmerabile  
230 V LED S14s EQ 27 W  
2700 K 275 lm Ra 80  
**G11859** € 38

**OSRAM LEDINESTRA  
2P 50 DIMM**

Ø500 mm  
opaco dimmerabile  
230 V LED S14s EQ 40 W  
2700 K 470 lm Ra 80  
**G11861** € 48

**OSRAM LEDINESTRA  
2P 100 DIMM**

Ø29x1000 mm  
opaco dimmerabile  
230 V LED S14s EQ 75 W  
2700 K 1055 lm Ra 80  
**G12251** € 88

**OSRAM  
DULUX L**

Ø413 mm  
opaco  
230 V LED 2G11 EQ 36 W  
3000 K 2070 lm Ra 80  
**G13469** € 48

**OSRAM  
DULUX L**

Ø413 mm  
opaco  
230 V LED 2G11 EQ 36 W  
4000 K 2300 lm Ra 80  
**G13470** € 48

**OSRAM  
STAR**

Ø75x28 mm  
230 V LED GX53 EQ 40 W  
2700 K ∠120° 470 lm Ra 80  
**G13032** € 11.50

**OSRAM  
STAR**

Ø75x28 mm  
230 V LED GX53 EQ 40 W  
4000 K ∠120° 470 lm Ra 80  
**G13033** € 11.50

**PUC  
SORGENTE LUMINOSA**

Ø74x27 mm  
230 V LED GX53 7 W  
3000 K ∠105° 560 lm Ra 80  
**G12340** € 8





ACCESSORI PER LAMPADE



### DRIVER

Driver LED 350mA.

#### DRIVER LED 1-3W

350 mA 4,2W

**G13124**

**€ 5.80**

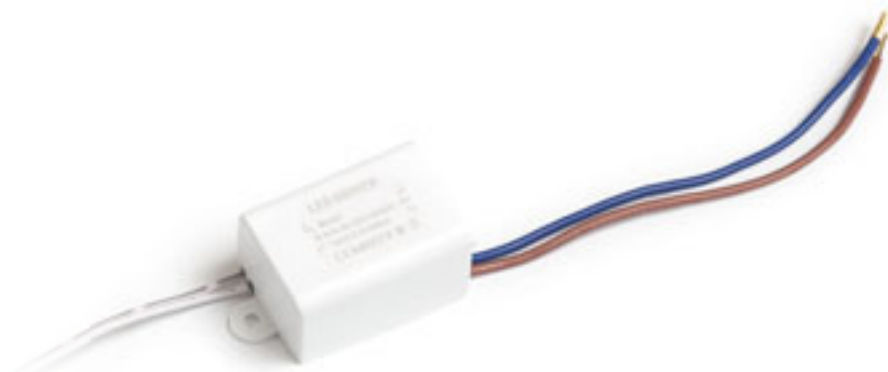
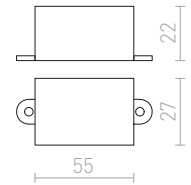

### DRIVER

Driver LED 700mA.

#### DRIVER LED 1x3W

700 mA 3 W

**G13125**

**€ 5.80**

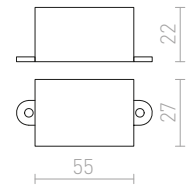

### DRIVER

Driver LED 350mA.

#### DRIVER LED 3-8W

350 mA 8,5 W

**G13008**

**€ 28**

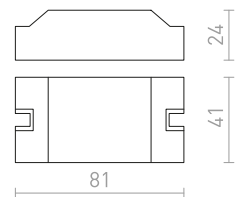

### DRIVER

Driver LED 350mA.

#### DRIVER LED 7-15W

350 mA 16 W

**G13806**

**€ 8.50**

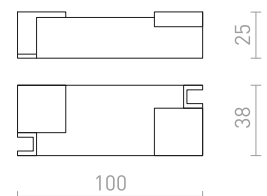



### TRASFORMATORE 12V

Trasformatore 12 AC.

#### TRAF0 20-70W 12V AC DIMM

12 V 70 W

G13002

€ 19

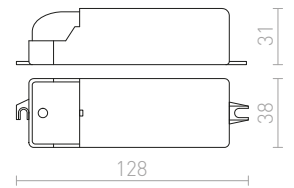

dimmerabile



### TRASFORMATORE 12V

Trasformatore 12 AC.

#### TRAF0 35-105W 12V AC DIMM

12 V 105 W

G13003

€ 22

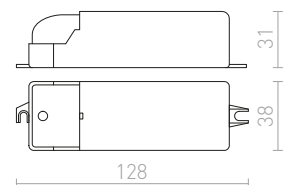

dimmerabile



### TRASFORMATORE 12V

Trasformatore 12 AC.

#### TRAF0 50-150W 12V AC DIMM

12 V 150 W

G13004

€ 58

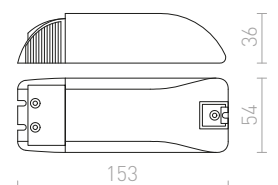

dimmerabile





## DRIVER

Driver LED 500mA 9-18W. Dimmerazione TRIAC.

### DRIVER LED 9-18W DIMM

500 mA max 18 W

G13840

€ 48

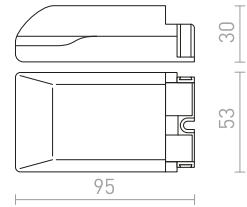

dimmerabile



## DRIVER

Driver LED 700mA 3x3W. Dimmerazione TRIAC.

### DRIVER LED 3x3W DIMM

700 mA 10 W

G13009

€ 35

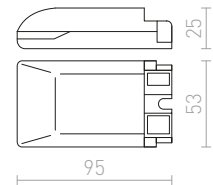

dimmerabile



IP67

## TRASFORMATORE 12V=

Trasformatore 12V DC.

### TRAF0 0-20W

230 V/12 V= 20 W IP67

G14018

€ 22

NEW

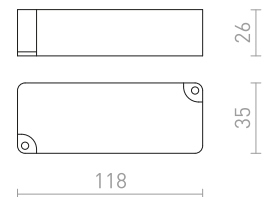

## TRASFORMATORE 24V=

Trasformatore 24V DC.

### TRAF0 0,5-20W

24= 20 W

G13006

€ 48

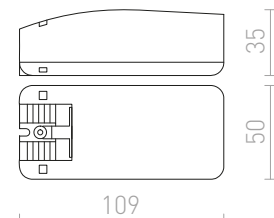



IP44

**IP-BOX**

Morsetiera con protezione per ambienti umidi. Adatto per cavi 3 x1,5.

**IP-BOX**

IP44

G12582 bianco

€ 1.80

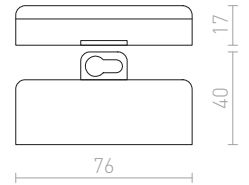

IP67

**IP-BOX**

Raccordo per cavo, adatto per ambienti esterni. Adatto per cavo 3x1,5.

**IP-BOX**

230 V IP67

G12984

€ 5.20

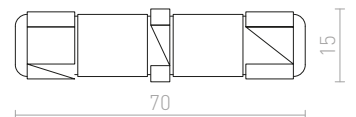

IP65

**IP-BOX**

Box di connessione adatto per ambienti esterni. Adatto per cavo 3x1,5.

**IP-BOX**

230 V IP65

G12983

€ 3.80

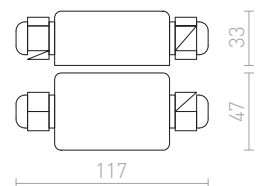

IP68

**IP-BOX**

Raccordo per cavo, adatto per ambienti esterni. Adatto per cavi 2x1,5. Fornito con 4 pezzi di manicotti e 2 pezzi di tappi.

**IP-BOX IP68**

IP68

G13846 nero

€ 12

NEW

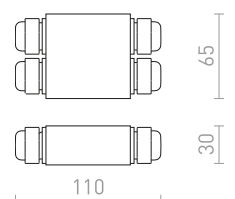



## SENSOR

Adattatore con portalampada E27, sensore di movimento integrato.

### SENSOR E27

230 V E27 60 W  $\angle 360^\circ$

G12752

€ 11 %

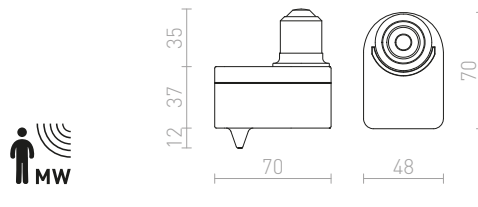

## SENSOR

Sensore di movimento per montaggio a soffitto o da parete.

### SENSOR DA SOFFITTO

230 V max 2000 W  $\angle 360^\circ$

G12754

€ 12.50

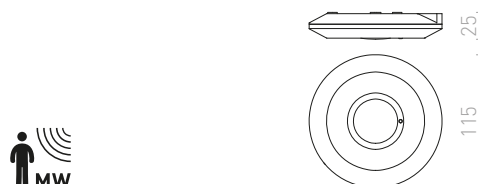

## SENSOR

Sensore di movimento per l'installazione in apparecchi adatti.

### SENSOR PER MONTAGGIO IN IMPIANTO LUCE

230 V max 1200 W  $\angle 360^\circ$

G12755 bianco

€ 10.50

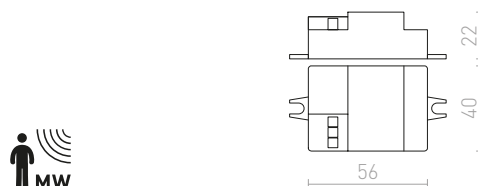

IP65



## IP-BOX

Box resistente per ambienti umidi per proteggere il sensore di movimento G12755.

### IP-BOX PER SENSORE G12755

IP65

G12756

€ 4.80 %

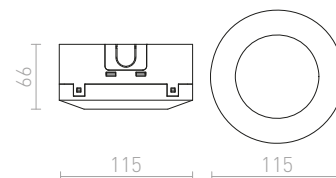

**SENSOR**

Sensore di movimento con sensore di luce esterno sul cavo. Il sensore esterno viene utilizzato solo per rilevare (determinare) l'intensità della luce per il corretto funzionamento del sensore.

**SENSOR PER CONTROSOFFITTO**

max 1200 W  $\angle 360^\circ$

G12753 bianco

€ 13.50

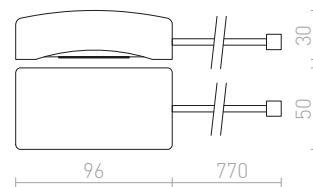
**SENSOR**

Sensore di movimento per il montaggio su apparecchi di illuminazione.

**SENSOR PER IL MONTAGGIO SU LAMPADE ESTERNE**

230 V max 500 W  $\angle 180^\circ$  IP65

G12757 bianco

€ 6 %

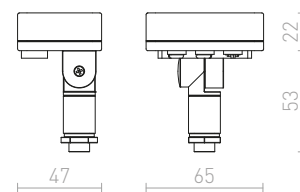

IP65

**DARK SENSOR**

Interruttore crepuscolare per la connessione automatica con un rilevatore esterno.

**DARK SENSOR 5-50 LUX INTEGRATO**

230 V IP44

G12758 bianco

€ 5 %

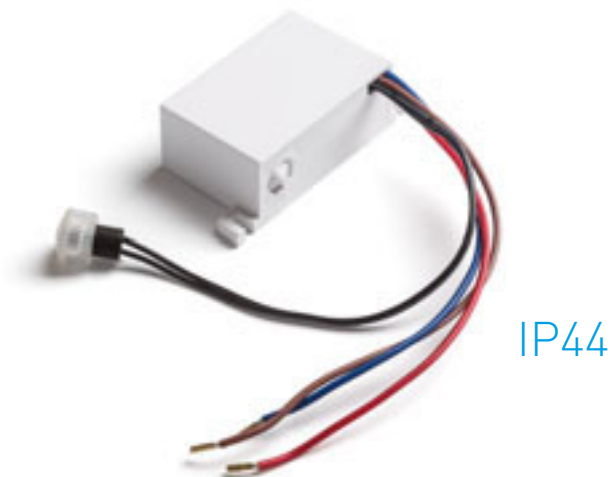
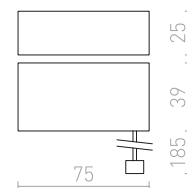

IP44

**DARK SENSOR**

Interruttore crepuscolare per la connessione automatica, adatto anche per uso esterno.

**DARK SENSOR 2-100 LUX APPLIQUE**

230 V IP44

G12759 nero

€ 7.80

G13528 bianco

€ 7.80

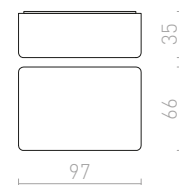

IP44

**1****1F** binario 532-533**A****ABAX** paletto 638-639**ACASA** da incasso 446-447**ACUA** da incasso 400-401**ADAGIO** da parete 196-197**AGATE** da parete 250-251**AGATE** da soffitto 138-139**AGNETA**

per binario monofase a sospensione 554-555

**AGNETA** per binario trifase a sospensione 522-523**AGNETA** applique/plafoniera 310-311**AGNETA** a sospensione 64-65**AIM** a collo di cigno 304-305**AINO** a sospensione 30-31**AKORD** da incasso a parete 722-723**ALFA** 740-741**ALGOT** da tavolo 338-339**ALLEGRO** DIMM da soffitto 154-155**ALVIS** piedistallo da terra 612-613**ALVIS** piedistallo da tavolo 612-613**ALVIS** paralume / lampade da tavolo 576-577**ALVIS/AMBITUS** da terra 352-353**ALVIS/AMBITUS** da tavolo 322-323**ALVIS/ILUSION** da terra 352-353**ALVIS/RIDICK** da terra 352-353**ALVIS/RON** da tavolo 324-325**AMADEUS** da parete 282-283**AMARO** da incasso 474-475**AMBER** da parete 262-263**AMBITUS** da terra 352-353**AMBITUS** paralume / lampade da terra 576-577**AMBITUS** piedistallo da terra 612-613**AMBITUS** piedistallo da tavolo 612-613**AMBITUS** paralume / lampade da tavolo 576-577**AMBITUS/ALVIS** da tavolo 322-323**AMENITY** da parete 194-195**AMICI** a sospensione in silicone 26-27**AMIGA** DIMM 394-395**ANDANTE** da parete 668-669**ANIKA** da tavolo 342-343**ANTE** parete 226-227**APRIORI** 398-399**AQUILA** da parete 262-263**ARANA** da soffitto 104-105**ARAQ** da parete 278-279**ARAQ** per binario monofase a sospensione 548-549**ARAQ** per binario trifase a sospensione 520-521**ARAQ** a sospensione 64-65**ASHLEY** da parete 224-225**ASPRO** paralume 572-573**ASTERI** a sospensione 76-77**ASTERIA** da incasso 470-471**ASTON** per binario trifase 522-523**ASTON** a sospensione 66-67**ASTOR** 402-403**ASTRAL** a sospensione 32-33**ASTROMET** a sospensione 32-33**ATHI** da parete 238-239**ATLANTA** applique/plafoniera 238-239**AWE** da soffitto 100-101**AZRIA** a sospensione 42-43**B****BABADES** per binario monofase 552-553**BABADES** per binario trifase 526-527**BABADES** a sospensione 70-71**BABU** a sospensione 40-41**BABYMOON** a sospensione o da terra 630-631**BAHIA** per binario trifase 504-505**BALEA** per armadio 190-191**BAROQUE** da parete 310-311**BARRY** da soffitto 100-101**BEACON** da parete 630-631**BEAT** paralume a sospensione 572-573**BEAU MONDE** a sospensione 34-35**BEEBA** per binario monofase 544-545**BEEBA** per binario trifase 510-511**BEJA** da parete 684-685**BELENOS** per binario monofase 540-541**BELENOS**

per binario monofase a sospensione 552-553

**BELENOS** per binario trifase 508-509**BELENOS** per binario trifase a sospensione 526-527**BELENOS** da soffitto 126-127**BELENOS** a sospensione 62-63**BELI** da incasso 396-397**BELLA** da incasso 392-393**BELLINI**

per binario monofase a sospensione 548-549

**BELLINI** per binario trifase 516-517**BELLINI** a sospensione 42-43**BEND** da parete con arco di base 608-609**BENITA** da parete 228-229**BERIT** da soffitto 140-141**BERMUDA** da incasso 398-399**BIANCA** da incasso 416-417**BIARITZ** da parete 242-243**BJORK** da incasso 448-449**BLONDIE** per binario monofase 554-555**BLONDIE** per binario trifase 522-523**BLONDIE** a sospensione 66-67**BLUESTAR** con picchetto 698-699**BOB** a collo di cigno 306-307**BOBO** da parete 264-265**BOBO** da terra 642-643**BODIE** da parete 228-229**BOGARD**

estensione per lampada a sospensione 62-63

**BOGARD** da parete 286-287**BOGARD** da soffitto 126-127**BOGARD** a sospensione 62-63**BOLLY** applique/plafoniera 206-207**BOLLY** da soffitto 106-107**BOLLY** a sospensione 36-37**BONDY** da incasso 438-439**BONNIE** da parete 634-635**BONNIE** paletto 634-635**BONO** plafoniera/applique 114-115**BORA** con picchetto 700-701**BORA** da parete 696-697**BOSANNA** da terra 632-633**BOSANOVA** da terra 632-633**BOULOGNE** da terra 354-355**BOURDON** da parete 682-683**BRAN** da incasso 404-405**BROADWAY** da tavolo 326-327**BROADWAY** a sospensione scorrevole 52-53**BROADWAY** a sospensione con braccio 54-55**BRUXEL** da parete 238-239**BUCKY** per binario trifase 524-525**BUCKY** a sospensione 24-25**BUGSY** da parete 316-317**BUGSY** da terra 370-371**BUGSY** da tavolo 344-345**BURTON** per binario trifase 528-529**BURTON** a sospensione 16-17**C****CABOX** da parete 674-675**CADENZA** per binario monofase 540-541**CADENZA** per binario trifase 506-507**CALLUM** da parete 210-211**CAMARGUE** da parete 660-661**CAMINO** da tavolo 338-339**CAMINO** da tavolo con paralume 338-339**CAMINO** a sospensione 16-17**CANTO** anello decorativo 132-133**CANTO** da soffitto senza anello decorativo 132-133**CARISSIMA** a sospensione 70-71**CARRE** da parete 240-241**CASSABLANCA** a sospensione 76-77**CASSAMBA** da parete 186-187**CASSIE** da parete 316-317**CASUAL** paralume 590-591**CELEIA** applique/plafoniera 310-311**CELEIA** da tavolo 342-343**CHIC** da parete 228-229**CHICAGO** da parete 666-667**CHLOE** da parete 252-253**CHOIX** da parete 692-693**CHOUPETTE** scorrevole da parete 278-279**CHOUPETTE** per binario monofase 552-553**CHOUPETTE** per binario trifase 520-521**CHOUPETTE** a sospensione 26-27**CINDY** a sospensione 32-33**CIRA** da soffitto 98-99**CLAIRE** da parete 658-659**CLANK** a sospensione 22-23**CLUB** da incasso 470-471**CLYDE** da parete 634-635**CLYDE** paletto 634-635**COCO** a sospensione 20-21**COIMBRA** da incasso 428-429**COLES** da soffitto 120-121**COLES** da soffitto inclinabile 120-121**COLIN** da soffitto 116-117**COMODO** da parete 672-673**CONDU** da soffitto 126-127**CONFETTI** a sospensione 20-21**CONNOR** per binario monofase 542-543**CONNOR** per binario trifase 506-507**CONNOR** da soffitto 130-131**CONNOR** paralume / lampade da terra 574-575**CONNOR** paralume / lampade da tavolo 574-575**CONNOR** paralume 574-575**COPA** per binari monofase 546-547**COPA** per binario trifase 516-517**COPA** a sospensione 64-65**CORAZON** 204-205**CORDOBA** con picchetto 698-699**COROA** a sospensione 44-45**CORONA** a sospensione 42-43**CORTINA** piedistallo da terra 616-617**CORTINA** piedistallo da tavolo 616-617**CORTINA/JAKARANDA** da terra 362-363**COSMO** con picchetto 700-701**COWLEY** da parete 230-231**COZY** da tavolo 346-347**CRESCENDO** da parete 200-201**CRESCENT** da parete 232-233**D****DADA** da incasso 450-451**DADOS** a sospensione 50-51



|  |         |  |         |  |         |
|--|---------|--|---------|--|---------|
| <b>DAFFY</b> da parete                         | 242-243 | <b>ESPLANADE</b> da tavolo             | 330-331 | <b>GRANDE</b> da soffitto                  | 96-97   |
| <b>DAG</b> da incasso                          | 418-419 | <b>ESPLANADE</b> a sospensione         | 26-27   | <b>GRANITA</b> da parete                   | 228-229 |
| <b>DAISY</b> paralume a sospensione            | 572-573 | <b>ESSEX</b> da parete                 | 248-249 | <b>GUN</b> con picchetto                   | 698-699 |
| <b>DAN</b> da incasso                          | 426-427 | <b>ESTRA</b> a sospensione             | 48-49   |  |         |
| <b>DANDY</b> da incasso                        | 418-419 | <b>ETESIAN</b> da terra                | 360-361 | <b>H</b>                                   |         |
| <b>DANTE</b> da terra                          | 358-359 | <b>EUTRAC</b> binario trifase          | 490-491 | <b>HAREN</b> applique/plafoniera           | 278-279 |
| <b>DARIO</b> anello decorativo                 | 128-129 | <b>EZRA</b> a sospensione              | 22-23   | <b>HAY</b> da parete                       | 234-235 |
| <b>DARIO</b> per binario monofase              | 542-543 |  |         | <b>HEAVY DUTY</b> riflettore esterno       | 702-703 |
| <b>DARIO</b> per binario trifase               | 506-507 | <b>F</b>                               |         | <b>HEIDI</b> da tavolo                     | 338-339 |
| <b>DARIO</b> da soffitto                       | 128-129 | <b>FABIO</b> set da sospensione        | 602-603 | <b>HEIDI</b> a sospensione                 | 14-15   |
| <b>DARK SENSOR</b> applique                    | 750-751 | <b>FACA</b> da incasso                 | 722-723 | <b>HEX</b> set da sospensione              | 598-599 |
| <b>DARK SENSOR</b> integrato                   | 750-751 | <b>FADO</b> da parete                  | 280-281 | <b>HIDE</b> da parete                      | 668-669 |
| <b>DEJAVU</b> da incasso                       | 480-481 | <b>FADO</b> terra                      | 370-371 | <b>HUDSON</b> da parete                    | 218-219 |
| <b>DELISA</b> paralume                         | 580-581 | <b>FADO</b> da tavolo                  | 346-347 | <b>HUE DIMM</b> da soffitto                | 152-153 |
| <b>DELTA</b> da parete                         | 666-667 | <b>FANCY</b> a sospensione             | 28-29   | <b>HUE DIMM</b> da incasso                 | 454-455 |
| <b>DELTA</b> applique/plafoniera               | 664-665 | <b>FANGIO</b> per binario trifase      | 504-505 | <b>HUE</b> da soffitto                     | 150-151 |
| <b>DESMOND</b> da parete                       | 250-251 | <b>FAO</b> da parete                   | 204-205 | <b>HUE</b> da incasso                      | 452-453 |
| <b>DESTY</b> per binario monofase              | 554-555 | <b>FAROS</b> esterno                   | 704-705 |  |         |
| <b>DESTY</b> per binario trifase               | 526-527 | <b>FAX</b> per binario trifase         | 512-513 | <b>I</b>                                   |         |
| <b>DESTY</b> a sospensione                     | 64-65   | <b>FIATLUX</b> a sospensione           | 28-29   | <b>ICAR</b> per binario monofase           | 552-553 |
| <b>DEZA</b> quadrato                           | 112-113 | <b>FIT</b> cavo PPM                    | 618-619 | <b>ICAR</b> a sospensione                  | 26-27   |
| <b>DIDO</b> da parete                          | 248-249 | <b>FIT</b> cavo in tessuto PPM         | 618-619 | <b>ILLUSION</b> paralume                   | 578-579 |
| <b>DIFFUSER</b>                                | 588-589 | <b>FIT</b> cavo in tessuto             | 618-619 | <b>ILUSIA</b> a sospensione                | 16-17   |
| <b>DIFFUSER PRISM</b>                          | 582-583 | <b>FIZZ</b> inclinabile                | 440-441 | <b>IMPERIA</b> da parete                   | 196-197 |
| <b>DINGO</b> inclinabile                       | 424-425 | <b>FLAP</b> da parete                  | 308-309 | <b>IMPERISO</b>                            | 184-185 |
| <b>DINGO</b> fisso                             | 422-423 | <b>FLATLINE</b> per binario trifase    | 496-497 | <b>INCA</b>                                | 404-405 |
| <b>DINGO</b> da incasso                        | 426-427 | <b>FLORIDA</b> a sospensione           | 14-15   | <b>INEZ</b>                                | 392-393 |
| <b>DINO</b> inclinabile                        | 426-427 | <b>FLORIO</b>                          | 202-203 | <b>INTRO</b>                               | 476-477 |
| <b>DIREZZA</b> con picchetto                   | 698-699 | <b>FOCUS DIMM</b> per binario monofase | 536-537 | <b>IP-BOX</b>                              | 748-749 |
| <b>DIREZZA</b> da parete                       | 694-695 | <b>FOCUS DIMM</b> per binario trifase  | 498-499 | <b>IP-BOX</b> per sensore G12755           | 750-751 |
| <b>DIXIE</b> da parete                         | 688-689 | <b>FOND</b> da parete                  | 238-239 | <b>IPSO</b>                                | 428-429 |
| <b>DOUBLE</b> paralume                         | 586-587 | <b>FORZA</b> per binario monofase      | 540-541 | <b>IPSO</b> fisso                          | 428-429 |
| <b>DRIVER</b>                                  | 746-747 | <b>FORZA</b> per binario trifase       | 508-509 | <b>IRIA</b> da incasso                     | 464-465 |
| <b>DRIVER DIMM</b>                             | 748-749 | <b>FOX</b> riflettore esterno          | 694-695 | <b>ISLA</b> da incasso                     | 404-405 |
| <b>DUBLIN</b> applique/plafoniera              | 208-209 | <b>FRISCO</b> da parete                | 304-305 | <b>ITAKA</b> da parete                     | 710-711 |
| <b>DUDE</b> da parete                          | 290-291 | <b>FRISCO</b> da tavolo                | 344-345 |  |         |
| <b>DUDE</b> per binario monofase               | 540-541 | <b>FRUTTI</b> per binario trifase      | 528-529 | <b>J</b>                                   |         |
| <b>DUDE</b> per binario trifase                | 508-509 | <b>FRUTTI</b> a sospensione            | 18-19   | <b>JACK</b> da parete                      | 234-235 |
| <b>DUDE</b> applique/plafoniera                | 290-291 |  |         | <b>JACK</b> per binario trifase            | 528-529 |
| <b>DUGME</b>                                   | 292-293 | <b>G</b>                               |         | <b>JACK</b> da soffitto                    | 118-119 |
| <b>DURANT</b> parete                           | 662-663 | <b>GAN</b> da parete                   | 230-231 | <b>JACK</b> a sospensione                  | 16-17   |
|  |         | <b>GAP</b> da incasso                  | 722-723 | <b>JAKARANDA</b> paralume                  | 578-579 |
| <b>E</b>                                       |         | <b>GARBO</b> da tavolo                 | 342-343 | <b>JAMAICA</b> a sospensione               | 24-25   |
| <b>EDIKA</b> da terra                          | 360-361 | <b>GARDETTE</b> da terra               | 356-357 | <b>JAMES DIMM</b> da soffitto              | 140-141 |
| <b>EDIKA</b> da tavolo                         | 330-331 | <b>GARDETTE</b> da tavolo              | 324-325 | <b>JERSEY</b> da parete                    | 218-219 |
| <b>EIGHT</b> per binario trifase a sospensione | 518-519 | <b>GARDIEN</b> terra                   | 642-643 | <b>JOLI</b> da parete                      | 310-311 |
| <b>EIGHT</b> da soffitto                       | 108-109 | <b>GARNISH</b> per binario trifase     | 518-519 | <b>JOLI</b> da tavolo                      | 344-345 |
| <b>EIGHT</b> a sospensione                     | 46-47   | <b>GARNISH</b> a sospensione           | 46-47   | <b>JULIETTA</b> per binario monofase       | 550-551 |
| <b>EILEEN</b> da soffitto                      | 110-111 | <b>GARRET</b> da parete                | 636-637 | <b>JULIETTA</b> per binario trifase        | 516-517 |
| <b>EKE</b> da parete                           | 304-305 | <b>GARY</b> con picchetto              | 700-701 | <b>JULIETTA</b> a sospensione              | 40-41   |
| <b>EL PASO</b> da tavolo                       | 324-325 | <b>GAVIN</b> da parete                 | 670-671 |  |         |
| <b>ELECTRA</b>                                 | 430-431 | <b>GAYA</b>                            | 136-137 | <b>K</b>                                   |         |
| <b>ELIA</b> da parete                          | 632-633 | <b>GERI</b> da parete                  | 680-681 | <b>KANE</b> da parete                      | 678-679 |
| <b>ELIA</b> da terra                           | 632-633 | <b>GIFT</b> a sospensione              | 48-49   | <b>KAY</b> da incasso                      | 416-417 |
| <b>ELICA</b> da esterno                        | 466-467 | <b>GIGI</b> da parete                  | 680-681 | <b>KAYA</b> da parete                      | 308-309 |
| <b>ELICA</b> da incasso                        | 466-467 | <b>GINA</b> da parete                  | 228-229 | <b>KEIG</b> da soffitto                    | 650-651 |
| <b>ELISA</b> per binari monofase               | 554-555 | <b>GINA</b> da soffitto                | 116-117 | <b>KEITH</b> piedistallo da tavolo con USB | 614-615 |
| <b>ELISA</b> per binario trifase               | 530-531 | <b>GINO</b> da parete                  | 662-663 | <b>KEITH/ALVIS</b> da tavolo con USB       | 326-327 |
| <b>ELISA</b> serie a sospensione               | 600-601 | <b>GIULIA</b> per binario monofase     | 550-551 | <b>KEITH/AMBITUS</b> da tavolo con USB     | 328-329 |
| <b>ELISEO</b> da parete                        | 284-285 | <b>GIULIA</b> per binario trifase      | 520-521 | <b>KEITH/DELISA</b> da tavolo con USB      | 326-327 |
| <b>ELISEO</b> applique/plafoniera              | 300-301 | <b>GIULIA</b> a sospensione            | 58-59   | <b>KEITH/RON</b> da tavolo con USB         | 334-335 |
| <b>ELLA</b> a sospensione                      | 14-15   | <b>GLAMOUR</b> a sospensione           | 28-29   | <b>KELLY</b> dimm da parete                | 298-299 |
| <b>ENCOMBRE</b> a sospensione                  | 20-21   | <b>GLANS</b> da parete                 | 212-213 | <b>KELLY</b> dimm da soffitto              | 296-297 |
| <b>ENKI</b>                                    | 138-139 | <b>GLOSSY</b>                          | 302-303 | <b>KELLY DIMM</b> da incasso               | 130-131 |
| <b>ENZO</b> set da sospensione                 | 602-603 | <b>GLOSSY</b> a collo di cigno         | 302-303 | <b>KELLY DIMM</b> da incasso               | 432-433 |
| <b>EQUA</b>                                    | 398-399 | <b>GOLDIE</b> a sospensione            | 72-73   | <b>KELLY</b> da parete                     | 296-297 |
| <b>ESICA</b> da soffitto                       | 108-109 | <b>GORDIQ</b> da incasso               | 478-479 | <b>KELLY</b> per binario trifase           | 512-513 |
| <b>ESME</b> a sospensione                      | 18-19   | <b>GORRA</b> da soffitto               | 100-101 | <b>KENNY</b> anello decorativo             | 288-289 |
| <b>ESPLANADE</b> da terra                      | 358-359 | <b>GRANADA</b>                         | 434-435 | <b>KENNY</b> applique/plafoniera           | 288-289 |



|  |         |  |         |   |         |
|--|---------|--|---------|---|---------|
| <b>POSTE</b> base per soffitto               | 604-605 | <b>SHARM</b> da incasso                | 386-387 | <b>TRICA</b> per binario monofase         | 544-545 |
| <b>PRAGMA</b> da terra                       | 368-369 | <b>SHARP</b> da parete                 | 218-219 | <b>TRICA</b> per binario trifase          | 510-511 |
| <b>PRIO LED</b> da parete                    | 254-255 | <b>SHOW</b> da parete                  | 306-307 | <b>TRIDENT</b> corpo                      | 84-85   |
| <b>PRODIGI</b> per binario trifase           | 504-505 | <b>SID</b> da parete                   | 232-233 | <b>TRIDENT</b> set da sospensione 2 pezzi | 84-85   |
| <b>PUC</b> sorgente luminosa                 | 742-743 | <b>SIENA</b> da parete                 | 284-285 | <b>TRIP</b> da parete                     | 248-249 |
| <b>PULIRE</b> per binario monofase           | 548-549 | <b>SIENA</b> per binario monofase      | 542-543 | <b>TRIX</b> set da sospensione            | 604-605 |
| <b>PULIRE</b> a sospensione                  | 44-45   | <b>SINTRA</b> per binario trifase      | 524-525 | <b>TUBA</b> da parete                     | 242-243 |
| <b>PURINA</b> per binario monofase           | 544-545 | <b>SINTRA</b> a sospensione            | 68-69   | <b>TUBA</b> da soffitto                   | 132-133 |
| <b>PURINA</b> per binario trifase            | 510-511 | <b>SIV</b> plafoniera/applique         | 682-683 | <b>TUTTI</b> per binario trifase          | 528-529 |
|  |         | <b>SLENDER</b> plafoniera/applique     | 168-169 | <b>TUTTI</b> a sospensione                | 18-19   |
|  |         | <b>SLENDER</b> da incasso              | 460-461 | <b>TWIST</b> da parete                    | 254-255 |
|  |         | <b>SNAZZY</b>                          | 128-129 |   |         |
| <b>Q</b>                                     |         | <b>SOBER</b> da incasso                | 442-443 | <b>U</b>                                  |         |
| <b>QUADRA</b> da soffitto                    | 650-651 | <b>SOCORRO</b> plafoniera/applique     | 168-169 | <b>UKKO</b> da parete                     | 250-251 |
| <b>QUO</b> da incasso                        | 420-421 | <b>SOCORRO</b> da incasso              | 460-461 |   |         |
|  |         | <b>SOLARIS</b> applique/plafoniera     | 122-123 | <b>V</b>                                  |         |
| <b>R</b>                                     |         | <b>SOLO</b> base per soffitto          | 604-605 | <b>VADE</b>                               | 132-133 |
| <b>RADICAL</b> a sospensione                 | 14-15   | <b>SONET</b> da parete                 | 638-639 | <b>VADIS</b> da parete                    | 636-637 |
| <b>RAGG</b> da incasso                       | 476-477 | <b>SONET</b> paletto                   | 638-639 | <b>VADIS</b> paletto                      | 636-637 |
| <b>RALLONG</b> base per soffitto             | 594-595 | <b>SONNY</b> da soffitto               | 652-653 | <b>VALE</b> da parete                     | 308-309 |
| <b>RALLONG</b> base a sospensione            | 594-595 | <b>SONYA</b>                           | 652-653 | <b>VALTO</b> da parete                    | 206-207 |
| <b>RARA</b> a sospensione                    | 22-23   | <b>SORANO</b> da parete                | 644-645 | <b>VALTO</b> applique/plafoniera          | 206-207 |
| <b>RASQ</b> da incasso a parete              | 476-477 | <b>SORANO</b> da soffitto              | 644-645 | <b>VARIA</b> da terra                     | 368-369 |
| <b>REDO</b> inclinabile                      | 316-317 | <b>SPECTACLE</b> plafoniera/applique   | 114-115 | <b>VECINO</b> da parete                   | 670-671 |
| <b>REEM</b> da parete                        | 246-247 | <b>SPIDER</b> set da sospensione       | 606-607 | <b>VENICE</b> da soffitto                 | 104-105 |
| <b>RENO</b> da parete                        | 708-709 | <b>SPIDER</b> connettore / maniglia    | 606-607 | <b>VERIA</b> da parete                    | 666-667 |
| <b>RENO</b> applique/plafoniera              | 708-709 | <b>SPLASH</b> da incasso               | 402-403 | <b>VERITA</b> da parete                   | 230-231 |
| <b>REWA</b> fisso                            | 442-443 | <b>SPRAY</b> da incasso                | 434-435 | <b>VERO</b> da incasso                    | 400-401 |
| <b>RIDICK</b> paralume                       | 578-579 | <b>STIG</b> da parete                  | 282-283 | <b>VERSA</b> parete                       | 306-307 |
| <b>RIGA</b> da soffitto                      | 130-131 | <b>STIG</b> da terra                   | 368-369 | <b>VERSA</b> da parete con paralume       | 220-221 |
| <b>RIGA</b> a sospensione                    | 60-61   | <b>STIG</b> a sospensione              | 60-61   | <b>VERSINA</b> con paralume               | 220-221 |
| <b>RINA</b> da parete                        | 642-643 | <b>STRUCTURAL</b> plafoniera/applique  | 174-175 | <b>VESCO</b> a sospensione                | 24-25   |
| <b>RINA</b> paletto                          | 642-643 | <b>STRUCTURAL</b> da incasso           | 462-463 | <b>VIENNA</b> applique/plafoniera         | 238-239 |
| <b>RINO</b> copertura decorativa             | 390-391 | <b>STRUCTURAL</b> a sospensione        | 80-81   | <b>VIP</b> reclinabile                    | 442-443 |
| <b>RINO</b> da incasso senza copertura       | 390-391 | <b>SWAY</b> per bagno                  | 184-185 | <b>VIPER</b>                              | 346-347 |
| <b>RIO</b> da incasso                        | 468-469 | <b>SWING</b> sopra quadro              | 256-257 | <b>VIRGO</b> da parete                    | 672-673 |
| <b>RITZY</b> da terra                        | 358-359 |  |         | <b>VOLCA</b> da soffitto                  | 120-121 |
| <b>RITZY</b> da tavolo                       | 340-341 | <b>T</b>                               |         | <b>VOLTERA</b> da parete                  | 284-285 |
| <b>RIZZ</b>                                  | 724-725 | <b>TACO</b> da soffitto                | 122-123 |   |         |
| <b>RODGE</b> da soffitto                     | 650-651 | <b>TAINA</b> con paralume              | 222-223 | <b>W</b>                                  |         |
| <b>ROLO</b> da parete                        | 236-237 | <b>TAMPA</b> coperture 2 pezzi         | 202-203 | <b>WATERBOY</b>                           | 390-391 |
| <b>RON</b> da parete                         | 214-215 | <b>TAMPA</b> da parete senza copertura | 202-203 | <b>WIM</b> da parete                      | 236-237 |
| <b>RON</b> paralume                          | 582-583 | <b>TAPA</b> da parete                  | 246-247 | <b>WISH DIMM</b> per binario monofase     | 538-539 |
| <b>ROSITA</b> da parete                      | 302-303 | <b>TAPIO</b> da parete                 | 280-281 | <b>WISH DIMM</b> per binario trifase      | 500-501 |
| <b>ROSITA</b> da terra                       | 368-369 | <b>TAPIO</b> da tavolo                 | 346-347 | <b>WOODY</b> piedistallo da tavolo        | 610-611 |
| <b>ROSITA</b> da tavolo                      | 344-345 | <b>TARIS</b> plafoniera/applique       | 654-655 | <b>WOOP</b> da parete                     | 660-661 |
| <b>ROSS</b> riflettore esterno               | 702-703 | <b>TECH</b> fisso                      | 444-445 |   |         |
| <b>ROSTAM</b> da parete con USB              | 278-279 | <b>TELO</b> da parete                  | 674-675 | <b>X</b>                                  |         |
| <b>ROZA</b> da parete                        | 246-247 | <b>TEMPO</b> paralume                  | 588-589 | <b>XYLO</b> da parete                     | 672-673 |
|  |         | <b>TERRA</b> da incasso                | 724-725 |   |         |
| <b>S</b>                                     |         | <b>TESS</b> da incasso                 | 474-475 | <b>Y</b>                                  |         |
| <b>SAMMY</b> da soffitto                     | 110-111 | <b>THALIA</b> da parete                | 282-283 | <b>YOLO</b> sopra specchio                | 190-191 |
| <b>SAMPO</b> da parete                       | 660-661 | <b>TIARA</b> da parete                 | 222-223 |   |         |
| <b>SANSSOUCI</b> per binario trifase         | 518-519 | <b>TICO</b> da parete                  | 262-263 | <b>Z</b>                                  |         |
| <b>SANSSOUCI</b> a sospensione               | 46-47   | <b>TIM</b> da incasso                  | 444-445 | <b>ZACK</b>                               | 684-685 |
| <b>SARA</b> da soffitto                      | 102-103 | <b>TIRAS</b> da parete                 | 658-659 | <b>ZALA</b> a sospensione                 | 22-23   |
| <b>SASSARI</b> da soffitto                   | 102-103 | <b>TITO DIMM</b> da parete             | 240-241 | <b>ZANE</b> da parete                     | 690-691 |
| <b>SAVOY</b> per armadio                     | 190-191 | <b>TITO</b> da parete                  | 240-241 | <b>ZARA</b> da soffitto                   | 102-103 |
| <b>SCOTT</b> da soffitto                     | 654-655 | <b>TOLEDO</b>                          | 394-395 | <b>ZAZA</b> da parete                     | 680-681 |
| <b>SEGNO</b> da incasso                      | 464-465 | <b>TOMBA</b> a sospensione             | 46-47   | <b>ZIZI</b> da incasso                    | 432-433 |
| <b>SELENA</b> da parete                      | 216-217 | <b>TOPIC</b> inclinabile               | 442-443 | <b>ZUMA</b> DIMM per binario trifase      | 500-501 |
| <b>SELMA</b> da parete                       | 682-683 | <b>TOPTOP</b>                          | 704-705 | <b>ZUMBA</b> da tavolo                    | 334-335 |
| <b>SEMPRE</b> sensore da soffitto            | 172-173 | <b>TOPTOP</b> da terra                 | 704-705 | <b>ZURI</b> da incasso                    | 446-447 |
| <b>SEMPRE</b> da soffitto                    | 170-171 | <b>TORINO</b> da parete                | 252-253 |   |         |
| <b>SENSOR</b>                                | 750-751 | <b>TRAF0</b>                           | 748-749 |   |         |
| <b>SENSOR</b> per controsoffitto             | 750-751 | <b>TRAF0</b> dimm                      | 746-747 |   |         |
| <b>SENSOR</b> per montaggio in impianto luce | 750-751 | <b>TRAX</b> per binario trifase        | 502-503 |   |         |
| <b>SENSOR</b>                                |         | <b>TREEZA</b> paletto                  | 640-641 |   |         |
| per il montaggio su lampade esterne          | 750-751 | <b>TRICA</b> da parete                 | 294-295 |   |         |
| <b>SENSOR</b> da soffitto                    | 750-751 |  |         |   |         |
| <b>SENZA</b> da soffitto                     | 648-649 |  |         |   |         |

|        |         |        |         |           |         |        |         |        |         |        |         |
|--------|---------|--------|---------|-----------|---------|--------|---------|--------|---------|--------|---------|
| G11837 | 740-741 | G13119 | 736-737 | G13944    | 732-733 | R10437 | 660-661 | R11296 | 170-171 |        | 492-493 |
| G11840 | 740-741 | G13120 | 740-741 | G13945    | 732-733 | R10438 | 660-661 | R11297 | 170-171 | R11352 | 490-491 |
| G11841 | 740-741 | G13122 | 738-739 | G13946    | 736-737 | R10439 | 660-661 | R11299 | 160-161 |        | 492-493 |
| G11849 | 736-737 | G13123 | 736-737 | G13947    | 734-735 | R10441 | 640-641 | R11300 | 490-491 | R11353 | 490-491 |
| G11852 | 740-741 | G13124 | 746-747 | G13948    | 734-735 | R10444 | 426-427 |        | 492-493 |        | 492-493 |
| G11859 | 742-743 | G13125 | 746-747 | G13949    | 734-735 | R10445 | 234-235 | R11301 | 490-491 | R11354 | 490-491 |
| G11860 | 742-743 | G13147 | 742-743 | G13950    | 734-735 | R10446 | 236-237 |        | 492-493 |        | 492-493 |
| G11861 | 742-743 | G13148 | 742-743 | G13951    | 734-735 | R10448 | 234-235 | R11302 | 490-491 | R11355 | 490-491 |
| G11862 | 742-743 | G13149 | 742-743 | G13952    | 734-735 | R10451 | 232-233 |        | 492-493 |        | 492-493 |
| G11867 | 584-585 | G13150 | 734-735 | G13953    | 734-735 | R10454 | 120-121 | R11303 | 490-491 | R11356 | 490-491 |
|        | 586-587 | G13151 | 736-737 | G13960    | 740-741 | R10455 | 234-235 |        | 492-493 |        | 492-493 |
| G11868 | 582-583 | G13152 | 734-735 | G14018    | 748-749 | R10465 | 236-237 | R11304 | 490-491 | R11357 | 494-495 |
|        | 586-587 | G13154 | 734-735 | R10119    | 140-141 | R10478 | 38-39   |        | 492-493 | R11358 | 490-491 |
| G11869 | 582-583 | G13155 | 738-739 | R10120    | 140-141 | R10479 | 38-39   | R11305 | 490-491 |        | 492-493 |
| G11870 | 588-589 | G13185 | 742-743 | R10122    | 142-143 | R10491 | 204-205 |        | 492-493 | R11359 | 492-493 |
| G11871 | 588-589 | G13306 | 736-737 | R10123    | 142-143 | R10492 | 108-109 | R11306 | 494-495 |        | 494-495 |
| G12065 | 740-741 | G13307 | 736-737 | R10124    | 134-135 | R10493 | 46-47   | R11307 | 490-491 | R11360 | 490-491 |
| G12067 | 742-743 | G13308 | 734-735 | R10129    | 244-245 | R10500 | 100-101 |        | 492-493 |        | 492-493 |
| G12068 | 742-743 | G13309 | 734-735 | R10132    | 244-245 | R10501 | 46-47   | R11308 | 490-491 | R11361 | 490-491 |
| G12206 | 740-741 | G13310 | 734-735 |           | 690-691 | R10509 | 46-47   |        | 492-493 |        | 492-493 |
| G12207 | 740-741 | G13311 | 734-735 | R10133    | 244-245 | R10510 | 48-49   | R11309 | 490-491 | R11362 | 490-491 |
| G12209 | 742-743 | G13406 | 740-741 |           | 740-741 | R10511 | 46-47   |        | 492-493 |        | 492-493 |
| G12232 | 740-741 | G13407 | 740-741 | R10148    | 440-441 | R10513 | 32-33   | R11310 | 494-495 | R11365 | 214-215 |
| G12234 | 740-741 | G13453 | 736-737 | R10166    | 112-113 | R10515 | 66-67   | R11311 | 490-491 | R11368 | 114-125 |
| G12237 | 736-737 | G13454 | 736-737 | R10170    | 244-245 | R10516 | 34-35   |        | 492-493 | R11370 | 574-575 |
| G12243 | 736-737 | G13455 | 736-737 |           | 690-691 | R10517 | 34-35   | R11312 | 490-491 | R11371 | 574-575 |
| G12244 | 734-735 | G13456 | 738-739 | R10171    | 142-143 | R10518 | 34-35   |        | 492-493 | R11372 | 574-575 |
| G12245 | 734-735 | G13457 | 736-737 |           | 316-317 | R10519 | 344-345 | R11313 | 490-491 | R11377 | 214-215 |
| G12246 | 734-735 | G13458 | 734-735 | R10173    | 316-317 | R10520 | 370-371 |        | 492-493 | R11381 | 214-215 |
| G12251 | 742-743 | G13459 | 734-735 | R10178    | 262-263 | R10521 | 316-317 | R11314 | 490-491 | R11383 | 214-215 |
| G12299 | 584-585 | G13460 | 734-735 | R10204    | 440-441 | R10522 | 76-77   |        | 492-493 | R11461 | 586-587 |
|        | 586-587 | G13461 | 734-735 | R10212    | 440-441 | R10527 | 700-701 | R11315 | 490-491 | R11462 | 582-583 |
| G12300 | 582-583 | G13462 | 734-735 | R10217    | 440-441 | R10530 | 698-699 |        | 492-493 | R11463 | 582-583 |
|        | 586-587 | G13464 | 738-739 | R10218    | 440-441 | R10532 | 724-725 | R11316 | 490-491 | R11464 | 214-215 |
| G12340 | 742-743 | G13465 | 740-741 | R10219    | 446-447 | R10536 | 24-25   |        | 492-493 | R11465 | 584-585 |
| G12366 | 560-561 | G13466 | 740-741 | R10251    | 618-619 | R10538 | 306-307 | R11317 | 490-491 | R11466 | 572-573 |
| G12367 | 560-561 | G13467 | 738-739 | R10252    | 618-619 | R10539 | 30-31   |        | 492-493 | R11467 | 572-573 |
| G12368 | 560-561 | G13468 | 738-739 | R10253    | 618-619 | R10540 | 30-31   | R11318 | 490-491 | R11468 | 574-575 |
| G12369 | 560-561 | G13469 | 742-743 | R10254    | 618-619 | R10541 | 304-305 |        | 492-493 | R11469 | 574-575 |
| G12370 | 560-561 | G13470 | 742-743 | R10262    | 194-195 | R10542 | 302-303 | R11319 | 490-491 | R11471 | 590-591 |
| G12371 | 560-561 | G13477 | 736-737 | R10263    | 194-195 | R10543 | 302-303 |        | 492-493 | R11472 | 590-591 |
| G12372 | 560-561 | G13478 | 738-739 | R10264    | 194-195 | R10545 | 722-723 | R11320 | 490-491 | R11473 | 592-593 |
| G12373 | 560-561 | G13518 | 734-735 | R10265    | 194-195 | R10546 | 722-723 |        | 492-493 | R11474 | 592-593 |
| G12374 | 560-561 | G13528 | 750-751 | R10266    | 232-233 | R10547 | 636-637 | R11321 | 490-491 | R11475 | 588-589 |
| G12375 | 560-561 | G13545 | 728-729 | R10269    | 424-425 | R10548 | 636-637 | R11321 | 492-493 | R11476 | 588-589 |
| G12377 | 560-561 | G13546 | 728-729 | R10270    | 424-425 | R10552 | 654-655 | R11322 | 490-491 | R11477 | 586-587 |
| G12378 | 560-561 | G13547 | 728-729 | R10271    | 422-423 | R10553 | 646-647 |        | 492-493 | R11478 | 586-587 |
| G12582 | 748-749 | G13572 | 736-737 | R10272    | 426-427 | R10554 | 674-675 | R11323 | 490-491 | R11479 | 582-583 |
| G12723 | 740-741 | G13573 | 734-735 | R10304    | 416-417 | R10555 | 724-725 | R11323 | 492-493 | R11480 | 582-583 |
| G12724 | 740-741 | G13574 | 738-739 | R10326    | 140-141 | R10557 | 722-723 | R11324 | 490-491 | R11481 | 584-585 |
| G12725 | 740-741 | G13575 | 738-739 | R10351    | 670-671 | R10558 | 470-471 |        | 492-493 | R11482 | 572-573 |
| G12726 | 740-741 | G13576 | 738-739 | R10352    | 688-689 |        | 714-715 | R11325 | 490-491 | R11483 | 572-573 |
| G12752 | 750-751 | G13577 | 730-731 | R10353    | 688-689 | R10565 | 394-395 |        | 492-493 | R11484 | 590-591 |
| G12753 | 750-751 | G13578 | 730-731 | R10354    | 688-689 | R10566 | 394-395 | R11326 | 490-491 | R11485 | 590-591 |
| G12754 | 750-751 | G13579 | 730-731 | R10355    | 688-689 | R10572 | 392-393 |        | 492-493 | R11486 | 592-593 |
| G12755 | 750-751 | G13581 | 734-735 | R10356    | 688-689 | R10574 | 402-403 | R11327 | 490-491 | R11487 | 592-593 |
| G12756 | 750-751 | G13655 | 740-741 | R10361    | 652-653 | R10576 | 100-101 |        | 492-493 | R11488 | 588-589 |
| G12757 | 750-751 | G13656 | 740-741 | R10362    | 652-653 | R10578 | 66-67   | R11328 | 490-491 | R11489 | 588-589 |
| G12758 | 750-751 | G13657 | 740-741 | R10363    | 652-653 | R10580 | 220-221 |        | 492-493 | R11490 | 582-583 |
| G12759 | 750-751 | G13670 | 84-85   | R10364    | 692-693 |        | 776-777 | R11329 | 490-491 | R11491 | 582-583 |
| G12983 | 748-749 |        | 174-175 | R10365    | 692-693 | R10581 | 76-77   |        | 492-493 | R11492 | 214-215 |
| G12984 | 748-749 | G13671 | 84-85   | R10366    | 692-693 | R10582 | 160-161 | R11330 | 490-491 | R11493 | 584-585 |
| G12985 | 738-739 |        | 174-175 | R10367    | 640-641 | R10584 | 78-79   |        | 492-493 | R11494 | 572-573 |
| G13002 | 746-747 | G13672 | 84-85   | R10368    | 640-641 | R10586 | 392-393 | R11331 | 490-491 | R11495 | 572-573 |
| G13003 | 746-747 | G13700 | 730-731 | R10372    | 630-631 | R10587 | 392-393 |        | 492-493 | R11496 | 574-575 |
| G13004 | 746-747 | G13705 | 740-741 | R10374    | 134-135 | R10588 | 190-191 | R11332 | 490-491 | R11497 | 574-575 |
| G13006 | 748-749 | G13706 | 740-741 | R10379    | 710-711 | R10591 | 316-317 |        | 492-493 | R11498 | 574-575 |
| G13008 | 746-747 | G13715 | 738-739 | R10380    | 640-641 | R10598 | 476-477 | R11333 | 490-491 | R11500 | 590-591 |
| G13009 | 748-749 | G13722 | 740-741 | R10382    | 652-653 | R10602 | 306-307 |        | 492-493 | R11501 | 590-591 |
| G13013 | 734-735 | G13723 | 740-741 | R10383    | 652-653 | R10604 | 302-303 | R11334 | 490-491 | R11502 | 592-593 |
| G13014 | 736-737 | G13724 | 740-741 | R10384    | 674-675 | R10605 | 30-31   |        | 492-493 | R11503 | 592-593 |
| G13015 | 736-737 | G13725 | 736-737 | R10385    | 650-651 | R10612 | 188-189 | R11335 | 490-491 | R11504 | 214-215 |
| G13020 | 742-743 | G13728 | 730-731 | R10386    | 650-651 | R10613 | 188-189 |        | 492-493 | R11505 | 588-589 |
| G13021 | 734-735 | G13749 | 86-87   | R10387    | 662-663 | R10614 | 188-189 | R11336 | 490-491 | R11506 | 588-589 |
| G13022 | 734-735 | G13750 | 86-87   | R10388    | 694-695 | R10615 | 604-605 |        | 492-493 | R11507 | 586-587 |
| G13023 | 734-735 | G13751 | 86-87   | R10395    | 400-401 | R10616 | 602-603 | R11337 | 490-491 | R11508 | 586-587 |
| G13024 | 734-735 | G13798 | 558-559 | R10395/12 | 400-401 | R10617 | 602-603 |        | 492-493 | R11509 | 214-215 |
| G13026 | 736-737 | G13799 | 558-559 | R10398    | 680-681 | R10618 | 602-603 | R11338 | 490-491 | R11510 | 584-585 |
| G13027 | 736-737 | G13800 | 556-557 | R10399    | 680-681 | R10620 | 26-27   |        | 492-493 | R11511 | 592-593 |
| G13028 | 736-737 | G13801 | 556-557 | R10400    | 248-249 | R10622 | 602-603 | R11339 | 490-491 | R11512 | 214-215 |
| G13029 | 736-737 |        | 558-559 | R10401    | 246-247 | R10623 | 602-603 |        | 492-493 | R11513 | 588-589 |
| G13032 | 742-743 | G13802 | 556-557 | R10402    | 444-445 | R10624 | 602-603 | R11340 | 490-491 | R11514 | 588-589 |
| G13033 | 742-743 |        | 558-559 | R10404    | 444-445 | R10625 | 602-603 |        | 492-493 | R11515 | 586-587 |
| G13034 | 738-739 | G13803 | 556-557 | R10407    | 400-401 | R10626 | 76-77   | R11341 | 494-495 | R11516 | 586-587 |
| G13035 | 738-739 |        | 558-559 | R10418    | 416-417 | R10639 | 466-467 | R11342 | 494-495 | R11517 | 582-583 |
| G13036 | 738-739 | G13804 | 556-557 | R10419    | 416-417 |        | 716-717 | R11343 | 494-495 | R11518 | 582-583 |
| G13037 | 738-739 |        | 558-559 | R10420    | 442-443 | R10640 | 512-513 | R11344 | 494-495 | R11519 | 214-215 |
| G13038 | 738-739 | G13806 | 746-747 | R10421    | 442-443 | R10641 | 512-513 | R11345 | 494-495 | R11520 | 584-585 |
| G13040 | 740-741 | G13820 | 556-557 | R10427    | 698-699 | R10644 | 512-513 |        | 490-491 | R11522 | 214-215 |
| G13041 | 740-741 | G13828 | 738-739 | R10428    | 112-113 | R10645 | 512-513 | R11346 | 492-493 | R11523 | 588-589 |
| G13043 | 738-739 | G13829 | 738-739 | R10428    | 648-649 | R11169 | 666-667 | R11347 | 490-491 | R11524 | 588-589 |
| G13044 | 738-739 | G13830 | 738-739 | R10429    | 112-113 | R11170 | 638-639 |        | 492-493 | R11535 | 586-587 |
| G13045 | 738-739 | G13831 | 736-737 | R10429    | 648-649 | R11171 | 638-639 | R11348 | 490-491 | R11541 | 592-593 |
| G13047 | 738-739 | G13832 | 736-737 | R10430    | 112-113 | R11281 | 168-169 |        | 492-493 | R11542 | 588-589 |
| G13098 | 736-737 | G      |         |           |         |        |         |        |         |        |         |



|        |         |        |         |         |         |         |         |         |         |         |         |         |
|--------|---------|--------|---------|---------|---------|---------|---------|---------|---------|---------|---------|---------|
| R11549 | 584-585 |        | R11753  | 670-671 | R11909  | 598-599 | R12046  | 428-429 | R12267  | 532-533 | R12365  | 230-231 |
| R11550 | 592-593 |        |         | 694-695 | R11910  | 598-599 | R12047  | 134-135 |         | 534-535 | R12379  | 338-339 |
| R11551 | 588-589 | R11754 | 702-703 | R11911  | 598-599 | R12048  | 100-101 | R12268  | 532-533 | R12380  | 14-15   |         |
| R11552 | 588-589 |        | 702-703 | R11912  | 598-599 | R12050  | 430-431 |         | 534-535 | R12381  | 20-21   |         |
| R11553 | 586-587 | R11755 | 702-703 | R11913  | 598-599 | R12052  | 430-431 | R12269  | 532-533 | R12382  | 20-21   |         |
| R11554 | 586-587 |        | 704-705 | R11914  | 598-599 | R12053  | 430-431 |         | 534-535 | R12383  | 20-21   |         |
| R11555 | 582-583 | R11756 | 46-47   | R11915  | 598-599 | R12054  | 32-33   | R12270  | 532-533 | R12384  | 20-21   |         |
| R11556 | 582-583 | R11758 | 306-307 | R11916  | 598-599 | R12055  | 42-43   |         | 534-535 | R12388  | 580-581 |         |
| R11557 | 214-215 | R11759 | 346-347 | R11917  | 598-599 | R12056  | 42-43   | R12271  | 532-533 | R12389  | 580-581 |         |
| R11558 | 584-585 | R11761 | 32-33   | R11918  | 598-599 | R12057  | 66-67   |         | 534-535 | R12392  | 578-579 |         |
| R11559 | 592-593 | R11765 | 70-71   | R11919  | 598-599 | R12059  | 504-505 | R12272  | 532-533 | R12393  | 578-579 |         |
| R11560 | 214-215 | R11766 | 70-71   | R11920  | 598-599 | R12060  | 504-505 |         | 534-535 | R12394  | 66-67   |         |
| R11561 | 588-589 | R11768 | 512-513 | R11922  | 598-599 | R12062  | 462-463 | R12273  | 532-533 | R12395  | 66-67   |         |
| R11562 | 588-589 | R11769 | 512-513 | R11923  | 598-599 | R12063  | 162-163 |         | 532-533 | R12396  | 68-69   |         |
| R11563 | 586-587 | R11770 | 128-129 | R11924  | 598-599 | R12064  | 174-175 | R12274  | 532-533 | R12397  | 68-69   |         |
| R11564 | 586-587 | R11771 | 128-129 | R11925  | 598-599 | R12072  | 490-491 |         | 534-535 | R12398  | 190-191 |         |
| R11565 | 582-583 | R11772 | 128-129 | R11926  | 598-599 |         | 492-493 | R12275  | 532-533 | R12399  | 190-191 |         |
| R11566 | 582-583 |        | 314-315 | R11927  | 598-599 | R12073  | 490-491 |         | 534-535 | R12400  | 190-191 |         |
| R11567 | 214-215 | R11773 | 128-129 | R11929  | 598-599 |         | 492-493 | R12276  | 532-533 | R12401  | 192-193 |         |
| R11568 | 584-585 |        | 314-315 | R11930  | 598-599 | R12074  | 490-491 |         | 534-535 | R12402  | 192-193 |         |
| R11569 | 592-593 | R11774 | 594-595 | R11931  | 598-599 |         | 492-493 | R12277  | 532-533 | R12403  | 192-193 |         |
| R11570 | 214-215 | R11775 | 594-595 | R11932  | 598-599 | R12076  | 292-293 |         | 534-535 | R12404  | 192-193 |         |
| R11573 | 582-583 | R11776 | 594-595 | R11933  | 598-599 | R12077  | 292-293 | R12278  | 532-533 | R12405  | 192-193 |         |
| R11574 | 582-583 | R11777 | 594-595 | R11934  | 598-599 | R12078  | 292-293 |         | 534-535 | R12406  | 192-193 |         |
| R11575 | 214-215 | R11778 | 596-597 | R11935  | 598-599 | R12081  | 70-71   | R12279  | 532-533 | R12407  | 200-201 |         |
| R11576 | 584-585 | R11779 | 596-597 | R11936  | 598-599 | R12082  | 70-71   |         | 534-535 | R12409  | 200-201 |         |
| R11577 | 572-573 | R11780 | 596-597 | R11937  | 598-599 | R12083  | 70-71   | R12280  | 532-533 | R12412  | 502-503 |         |
| R11578 | 572-573 | R11781 | 596-597 | R11938  | 598-599 | R12084  | 70-71   |         | 534-535 | R12413  | 502-503 |         |
| R11579 | 574-575 | R11782 | 596-597 | R11939  | 598-599 | R12085  | 64-65   | R12281  | 532-533 | R12416  | 14-15   |         |
| R11580 | 574-575 | R11783 | 596-597 | R11940  | 598-599 | R12086  | 64-65   |         | 534-535 | R12418  | 26-27   |         |
| R11581 | 574-575 | R11784 | 596-597 | R11941  | 598-599 | R12091  | 254-255 | R12282  | 532-533 | R12420  | 632-633 |         |
| R11582 | 590-591 | R11785 | 596-597 | R11942  | 598-599 | R12092  | 254-255 |         | 534-535 | R12421  | 632-633 |         |
| R11583 | 590-591 | R11786 | 596-597 | R11943  | 598-599 | R12094  | 518-519 | R12283  | 532-533 | R12434  | 170-171 |         |
| R11584 | 582-583 | R11787 | 596-597 | R11944  | 598-599 | R12095  | 518-519 |         | 534-535 | R12439  | 170-171 |         |
| R11585 | 582-583 | R11788 | 596-597 | R11945  | 598-599 | R12100  | 522-523 | R12284  | 532-533 | R12440  | 172-173 |         |
| R11586 | 214-215 | R11789 | 596-597 | R11946  | 672-673 | R12101  | 524-525 |         | 534-535 | R12441  | 172-173 |         |
| R11587 | 584-585 | R11791 | 610-611 | R11947  | 642-643 | R12102  | 524-525 | R12285  | 532-533 | R12442  | 172-173 |         |
| R11588 | 572-573 | R11795 | 594-595 | R11948  | 702-703 | R12103  | 528-529 |         | 534-535 | R12443  | 172-173 |         |
| R11589 | 572-573 | R11796 | 594-595 | R11949  | 708-709 | R12106  | 530-531 | R12286  | 532-533 | R12446  | 72-73   |         |
| R11590 | 574-575 | R11797 | 594-595 | R11950  | 708-709 | R12107  | 530-531 |         | 534-535 | R12447  | 72-73   |         |
| R11591 | 574-575 | R11798 | 594-595 | R11951  | 708-709 | R12108  | 530-531 | R12287  | 532-533 | R12448  | 130-131 |         |
| R11592 | 574-575 | R11799 | 604-605 | R11953  | 708-709 | R12109  | 530-531 |         | 534-535 | R12449  | 130-131 |         |
| R11593 | 590-591 | R11800 | 574-575 | R11954  | 708-709 | R12110  | 530-531 | R12288  | 532-533 | R12450  | 130-131 |         |
| R11594 | 590-591 | R11802 | 584-585 | R11957  | 118-119 | R12111  | 530-531 |         | 534-535 | R12451  | 130-131 |         |
| R11597 | 574-575 | R11803 | 584-585 | R11959  | 228-229 | R12112  | 530-531 | R12289  | 532-533 | R12452  | 130-131 |         |
| R11599 | 586-587 | R11804 | 584-585 | R11960  | 234-235 | R12113  | 530-531 |         | 534-535 | R12453  | 130-131 |         |
| R11600 | 586-587 | R11805 | 584-585 | R11963  | 704-705 | R12114  | 530-531 | R12290  | 532-533 | R12454  | 130-131 |         |
| R11607 | 582-583 | R11806 | 584-585 | R11964  | 674-675 | R12115  | 154-155 |         | 534-535 | R12455  | 130-131 |         |
| R11608 | 582-583 | R11809 | 584-585 | R11967  | 114-115 | R12120  | 160-161 | R12291  | 532-533 | R12458  | 60-61   |         |
| R11611 | 592-593 | R11810 | 584-585 |         | 654-655 | R12121  | 160-161 |         | 534-535 | R12459  | 60-61   |         |
| R11616 | 592-593 | R11811 | 584-585 | R11968  | 114-115 | R12186  | 460-461 | R12292  | 512-513 | R12461  | 280-281 |         |
| R11634 | 592-593 | R11812 | 590-591 |         | 654-655 | R12187  | 460-461 |         | 534-535 | R12462  | 346-347 |         |
| R11639 | 592-593 | R11813 | 590-591 | R11973  | 336-337 | R12196  | 100-101 | R12293  | 532-533 |         | 370-371 |         |
| R11676 | 16-17   | R11814 | 590-591 | R11976  | 218-219 | R12197  | 100-101 |         | 534-535 | R12464  | 332-333 |         |
| R11678 | 48-49   | R11815 | 590-591 | R11978  | 54-55   | R12198  | 108-109 | R12294  | 532-533 | R12465  | 332-333 |         |
| R11679 | 48-49   | R11816 | 590-591 | R11982  | 222-223 | R12199  | 108-109 |         | 534-535 | R12466  | 364-365 |         |
| R11680 | 116-117 | R11817 | 590-591 | R11983  | 336-337 | R12201  | 100-101 | R12295  | 532-533 | R12467  | 364-365 |         |
| R11682 | 390-391 | R11819 | 590-591 | R11984  | 366-367 | R12202  | 100-101 |         | 534-535 | R12470  | 360-361 |         |
| R11683 | 390-391 | R11820 | 590-591 | R11986  | 326-327 | R12214  | 618-619 | R12296  | 532-533 | R12471  | 122-123 |         |
| R11684 | 390-391 | R11822 | 590-591 | R11989  | 52-53   | R12216  | 618-619 |         | 534-535 | R12473  | 280-281 |         |
| R11685 | 390-391 | R11823 | 64-65   | R11990  | 616-617 | R12217  | 196-197 | R12297  | 532-533 | R12474  | 346-347 |         |
| R11686 | 390-391 | R11824 | 64-65   | R11991  | 616-617 | R12218  | 196-197 |         | 534-535 | R12475  | 370-371 |         |
| R11687 | 72-73   | R11872 | 600-601 | R11992  | 614-615 | R12219  | 196-197 | R12298  | 532-533 | R12476  | 282-283 |         |
| R11688 | 72-73   | R11873 | 600-601 | R11993  | 198-199 | R12220  | 200-201 |         | 534-535 | R12477  | 52-53   |         |
| R11689 | 72-73   | R11874 | 600-601 | R11996  | 198-199 | R12222  | 618-619 | R12305  | 510-511 | R12478  | 52-53   |         |
| R11690 | 72-73   | R11875 | 600-601 | R11998  | 198-199 | R12223  | 618-619 | R12306  | 510-511 | R12479  | 54-55   |         |
| R11691 | 72-73   | R11876 | 600-601 | R12006  | 510-511 | R12224  | 618-619 | R12307  | 510-511 | R12480  | 224-225 |         |
| R11692 | 72-73   | R11877 | 600-601 | R12007  | 510-511 | R12225  | 618-619 | R12308  | 544-545 | R12481  | 218-219 |         |
| R11694 | 502-503 | R11878 | 600-601 | R12009  | 444-445 | R12226  | 618-619 | R12310  | 544-545 | R12482  | 224-225 |         |
| R11698 | 68-69   | R11879 | 600-601 | R12010  | 680-681 | R12227  | 618-619 | R12311  | 510-511 | R12483  | 26-27   |         |
| R11699 | 68-69   | R11880 | 600-601 | R12012  | 692-693 | R12228  | 618-619 | R12312  | 510-511 | R12484  | 330-331 |         |
| R11700 | 68-69   | R11881 | 600-601 | R12013  | 474-475 | R12229  | 618-619 | R12313  | 510-511 | R12485  | 358-359 |         |
| R11701 | 68-69   | R11882 | 600-601 | R12013  | 716-717 | R12230  | 618-619 | R12314  | 544-545 | R12486  | 340-341 |         |
| R11706 | 32-33   | R11883 | 600-601 | R12014  | 474-475 | R12254  | 532-533 | R12316  | 544-545 | R12487  | 358-359 |         |
| R11707 | 68-69   | R11884 | 600-601 |         | 716-717 |         | 534-535 | R12317  | 510-511 | R12488  | 324-325 |         |
| R11715 | 38-39   | R11885 | 600-601 | R12015  | 474-475 | R12255  | 532-533 | R12318  | 510-511 | R12489  | 356-357 |         |
| R11724 | 512-513 | R11886 | 600-601 |         | 716-717 |         | 534-535 | R12319  | 510-511 | R12493  | 62-63   |         |
| R11725 | 390-391 | R11887 | 600-601 | R12018  | 666-667 | R12256  | 532-533 | R12320  | 544-545 | R12494  | 62-63   |         |
| R11726 | 390-391 | R11888 | 600-601 | R12021  | 686-687 |         | 534-535 | R12321  | 544-545 | R12495  | 62-63   |         |
| R11727 | 390-391 | R11889 | 600-601 | R12022  | 684-685 | R12257  | 532-533 | R12322  | 544-545 | R12496  | 62-63   |         |
| R11728 | 390-391 | R11890 | 600-601 | R12024  | 470-471 |         | 534-535 | R12332  | 296-297 | R12497  | 126-127 |         |
| R11729 | 390-391 | R11891 | 600-601 | R12024  | 714-715 | R12258  | 532-533 | R12333  | 296-297 |         | 312-313 |         |
| R11730 | 390-391 | R11892 | 600-601 | R12025  | 700-701 |         | 534-535 | R12334  | 296-297 | R12498  | 126-127 |         |
| R11731 | 442-443 | R11893 | 600-601 | R12027  | 684-685 | R12259  | 532-533 | R12335  | 296-297 |         | 312-313 |         |
| R11732 | 446-447 | R11894 | 600-601 | R12028  | 686-687 |         | 534-535 | R12336  | 296-297 | R12499  | 126-127 |         |
| R11733 | 402-403 | R11895 | 600-601 | R12029  | 470-471 | R12260  | 532-533 | R12337  | 296-297 |         | 312-313 |         |
| R11734 | 402-403 | R11896 | 600-601 | R12029  | 714-715 |         | 534-535 | R12338  | 512-513 | R12500  | 126-127 |         |
| R11735 | 402-403 | R11897 | 600-601 | R12030  | 470-471 | R12261  | 532-533 | R12339  | 512-513 |         | 312-313 |         |
| R11736 | 402-403 | R11898 | 600-601 | R12030  | 714-715 |         | 534-535 | R12350  | 468-469 | R12502  | 286-287 |         |
| R11738 | 442-443 | R11899 | 600-601 | R12033  | 314-315 | R12262  | 532-533 | R12354  | 116-117 | R12503  | 286-287 |         |
| R11740 | 390-391 | R11900 | 600-601 | R12033  | 694-695 |         | 534-535 | R12355  | 420-421 | R12504  | 286-287 |         |
| R11741 | 390-391 | R11901 | 600-601 | R12037  | 422-423 | R12263  | 532-533 | R12356  | 426-427 | R12505  | 286-287 |         |
| R11742 | 442-443 | R11902 | 600-601 | R12038  | 426-427 |         | 534-535 | R12357  | 418-419 | R12506  | 286-287 |         |
| R11743 | 442     |        |         |         |         |         |         |         |         |         |         |         |



|        |         |        |         |         |        |         |        |         |        |         |        |         |
|--------|---------|--------|---------|---------|--------|---------|--------|---------|--------|---------|--------|---------|
| R12515 | 642-643 |        | R12615  | 712-713 | R12743 | 246-247 | R12888 | 450-451 | R13067 | 458-459 | R13243 | 386-387 |
| R12516 | 134-135 |        |         | 472-473 | R12744 | 246-247 | R12889 | 450-451 | R13068 | 458-459 | R13244 | 386-387 |
| R12517 | 134-135 |        |         | 712-713 | R12745 | 132-133 | R12890 | 450-451 | R13069 | 458-459 | R13245 | 386-387 |
| R12525 | 654-655 | R12616 | 472-473 |         | R12746 | 398-399 | R12894 | 124-125 | R13070 | 458-459 | R13246 | 386-387 |
| R12527 | 428-429 |        | 712-713 |         | R12747 | 398-399 | R12896 | 306-307 | R13071 | 458-459 | R13247 | 386-387 |
| R12528 | 466-467 | R12618 | 472-473 |         | R12748 | 446-447 | R12897 | 306-307 | R13072 | 458-459 | R13248 | 386-387 |
|        | 714-715 |        | 712-713 |         | R12749 | 398-399 | R12898 | 308-309 | R13073 | 152-153 | R13249 | 386-387 |
| R12529 | 466-467 | R12619 | 472-473 |         | R12750 | 446-447 | R12900 | 418-419 | R13076 | 152-153 | R13250 | 388-389 |
|        | 716-717 |        | 712-713 |         | R12751 | 118-119 | R12901 | 204-205 | R13077 | 152-153 | R13251 | 388-389 |
| R12530 | 480-481 | R12621 | 472-473 |         | R12760 | 452-453 |        | 260-261 | R13078 | 152-153 | R13252 | 388-389 |
|        | 720-721 |        | 712-713 |         | R12761 | 452-453 | R12902 | 204-205 | R13082 | 152-153 | R13253 | 388-389 |
| R12531 | 480-481 | R12626 | 638-639 |         | R12763 | 452-453 | R12902 | 260-261 | R13083 | 166-167 | R13254 | 388-389 |
|        | 720-721 | R12627 | 476-477 |         | R12764 | 452-453 | R12903 | 202-203 | R13084 | 166-167 | R13255 | 388-389 |
| R12533 | 478-479 |        | 716-717 |         | R12765 | 452-453 |        | 260-261 | R13085 | 166-167 | R13256 | 388-389 |
|        | 718-719 | R12628 | 476-477 |         | R12766 | 452-453 | R12904 | 202-203 | R13086 | 166-167 | R13257 | 388-389 |
| R12534 | 478-479 |        | 716-717 |         | R12767 | 452-453 |        | 260-261 | R13087 | 166-167 | R13258 | 388-389 |
|        | 718-719 | R12633 | 130-131 |         | R12768 | 452-453 | R12905 | 202-203 | R13088 | 166-167 | R13259 | 388-389 |
| R12535 | 478-479 | R12634 | 130-131 |         | R12770 | 452-453 | R12906 | 202-203 | R13089 | 166-167 | R13260 | 388-389 |
|        | 718-719 | R12635 | 432-433 |         | R12771 | 452-453 | R12907 | 202-203 | R13090 | 166-167 | R13261 | 388-389 |
| R12536 | 478-479 | R12636 | 432-433 |         | R12772 | 452-453 | R12908 | 202-203 | R13091 | 166-167 | R13262 | 388-389 |
|        | 718-719 | R12637 | 296-297 |         | R12773 | 452-453 | R12911 | 398-399 | R13104 | 298-299 | R13263 | 388-389 |
| R12537 | 478-479 |        | 432-433 | R12638  | R12774 | 452-453 | R12912 | 288-289 | R13105 | 298-299 | R13264 | 388-389 |
|        | 718-719 |        | 296-297 |         | R12775 | 456-457 | R12913 | 288-289 | R13106 | 298-299 | R13267 | 158-159 |
| R12538 | 478-479 |        | 432-433 |         | R12776 | 456-457 | R12914 | 288-289 | R13107 | 298-299 | R13268 | 158-159 |
|        | 718-719 | R12639 | 194-195 |         | R12777 | 456-457 | R12915 | 288-289 | R13108 | 298-299 | R13271 | 28-29   |
| R12539 | 262-263 | R12640 | 194-195 |         | R12778 | 456-457 | R12916 | 288-289 | R13109 | 298-299 | R13275 | 30-31   |
|        | 710-711 | R12641 | 194-195 |         | R12780 | 456-457 | R12917 | 288-289 | R13113 | 576-577 | R13276 | 18-19   |
| R12540 | 262-263 | R12651 | 226-227 |         | R12781 | 456-457 | R12918 | 288-289 | R13113 | 610-611 | R13278 | 572-573 |
|        | 710-711 | R12652 | 226-227 |         | R12782 | 456-457 | R12919 | 288-289 | R13114 | 576-577 | R13279 | 572-573 |
| R12541 | 262-263 | R12654 | 608-609 |         | R12783 | 456-457 | R12920 | 288-289 | R13114 | 610-611 | R13280 | 24-25   |
|        | 710-711 | R12655 | 468-469 |         | R12784 | 456-457 | R12921 | 288-289 | R13126 | 420-421 | R13281 | 572-573 |
| R12542 | 262-263 | R12656 | 468-469 |         | R12785 | 456-457 | R12922 | 288-289 | R13127 | 454-455 | R13282 | 226-227 |
|        | 710-711 | R12657 | 404-405 |         | R12786 | 456-457 | R12923 | 288-289 | R13128 | 454-455 | R13283 | 340-341 |
| R12544 | 262-263 | R12659 | 404-405 |         | R12787 | 456-457 | R12924 | 288-289 | R13130 | 454-455 | R13284 | 218-219 |
|        | 710-711 | R12660 | 404-405 |         | R12788 | 456-457 | R12925 | 288-289 | R13131 | 454-455 | R13285 | 608-609 |
| R12545 | 262-263 | R12661 | 390-391 |         | R12789 | 456-457 | R12926 | 288-289 | R13132 | 458-459 | R13285 | 20-21   |
|        | 710-711 |        | 724-725 |         | R12790 | 150-151 | R12927 | 616-617 | R13133 | 458-459 | R13288 | 428-429 |
| R12547 | 262-263 | R12663 | 44-45   |         | R12791 | 150-151 | R12930 | 616-617 | R13134 | 458-459 | R13289 | 18-19   |
|        | 710-711 | R12664 | 44-45   |         | R12792 | 150-151 | R12931 | 16-17   | R13135 | 458-459 | R13290 | 18-19   |
| R12548 | 636-637 | R12665 | 330-331 |         | R12794 | 150-151 | R12932 | 56-57   | R13137 | 152-153 | R13293 | 338-339 |
| R12551 | 238-239 | R12666 | 360-361 |         | R12795 | 150-151 | R12933 | 56-57   | R13138 | 152-153 | R13294 | 338-339 |
|        | 656-657 | R12667 | 136-137 |         | R12798 | 150-151 | R12934 | 56-57   | R13139 | 152-153 | R13295 | 338-339 |
|        | 666-667 | R12668 | 136-137 |         | R12799 | 150-151 | R12935 | 56-57   | R13141 | 152-153 | R13296 | 16-17   |
| R12552 | 248-249 | R12669 | 132-133 |         | R12800 | 150-151 | R12940 | 344-345 | R13142 | 166-167 | R13297 | 16-17   |
| R12552 | 688-689 | R12670 | 128-129 |         | R12804 | 150-151 | R12942 | 304-305 | R13143 | 166-167 | R13298 | 14-15   |
| R12553 | 248-249 | R12672 | 138-139 |         | R12805 | 164-165 | R12943 | 308-309 | R13144 | 166-167 | R13300 | 434-435 |
|        | 688-689 | R12673 | 138-139 |         | R12806 | 164-165 | R12944 | 304-305 | R13145 | 166-167 | R13302 | 434-435 |
| R12555 | 250-251 | R12674 | 354-355 |         | R12807 | 164-165 | R12945 | 304-305 | R13157 | 148-149 | R13303 | 612-613 |
|        | 688-689 | R12675 | 342-343 |         | R12808 | 164-165 | R12947 | 610-611 | R13158 | 158-159 | R13304 | 612-613 |
| R12556 | 240-241 | R12677 | 250-251 |         | R12810 | 164-165 | R12949 | 184-185 | R13163 | 538-539 | R13315 | 22-23   |
|        | 676-677 | R12678 | 250-251 |         | R12811 | 164-165 | R12950 | 184-185 | R13164 | 148-149 | R13316 | 22-23   |
| R12557 | 240-241 | R12679 | 248-249 |         | R12812 | 164-165 |        | 256-257 | R13171 | 502-503 | R13319 | 22-23   |
|        | 676-677 | R12680 | 248-249 |         | R12813 | 164-165 | R12951 | 184-185 | R13172 | 502-503 | R13320 | 334-335 |
| R12559 | 662-663 | R12681 | 136-137 |         | R12814 | 164-165 |        | 256-257 | R13173 | 502-503 | R13321 | 22-23   |
| R12560 | 668-669 | R12682 | 136-137 |         | R12815 | 164-165 | R12954 | 256-257 | R13177 | 148-149 | R13324 | 330-331 |
| R12561 | 668-669 | R12684 | 136-137 |         | R12816 | 164-165 | R12955 | 220-221 | R13178 | 148-149 | R13325 | 330-331 |
| R12562 | 672-673 | R12685 | 470-471 |         | R12817 | 164-165 |        | 276-277 | R13182 | 60-61   | R13328 | 74-75   |
| R12563 | 664-665 |        | 714-715 |         | R12818 | 164-165 | R12956 | 222-223 | R13183 | 60-61   |        | 144-145 |
| R12564 | 664-665 | R12686 | 470-471 |         | R12823 | 504-505 |        | 276-277 | R13184 | 60-61   | R13329 | 74-75   |
| R12565 | 664-665 |        | 714-715 |         | R12824 | 504-505 | R12957 | 222-223 | R13201 | 554-555 |        | 144-145 |
| R12566 | 664-665 | R12687 | 466-467 |         | R12825 | 238-239 |        | 280-281 | R13202 | 554-555 | R13330 | 74-75   |
| R12567 | 666-667 | R12688 | 466-467 |         |        | 656-657 | R12960 | 690-691 | R13203 | 554-555 | R13331 | 74-75   |
| R12568 | 662-663 | R12690 | 474-475 |         | R12827 | 250-251 | R12963 | 460-461 | R13204 | 554-555 | R13332 | 74-75   |
| R12569 | 662-663 | R12691 | 692-693 |         |        | 688-689 | R12965 | 460-461 | R13205 | 546-547 |        | 144-145 |
| R12571 | 692-693 | R12695 | 432-433 |         | R12829 | 686-687 | R12973 | 168-169 | R13206 | 546-547 | R13333 | 74-75   |
| R12573 | 252-253 | R12696 | 432-433 |         | R12831 | 248-249 | R12977 | 544-545 | R13207 | 516-517 |        | 144-145 |
|        | 660-661 | R12697 | 436-437 |         |        | 686-687 | R12978 | 544-545 | R13208 | 516-517 | R13334 | 74-75   |
| R12574 | 252-253 | R12699 | 436-437 |         | R12832 | 248-249 | R12982 | 696-697 | R13209 | 548-549 |        | 144-145 |
|        | 660-661 | R12700 | 436-437 |         |        | 686-687 | R12986 | 310-311 | R13210 | 548-549 | R13335 | 74-75   |
| R12575 | 246-247 | R12702 | 436-437 |         | R12839 | 126-127 | R12989 | 368-369 | R13211 | 554-555 | R13337 | 186-187 |
| R12576 | 474-475 | R12703 | 436-437 |         | R12840 | 126-127 | R12990 | 60-61   | R13212 | 552-553 | R13338 | 324-325 |
|        | 716-717 | R12704 | 436-437 |         | R12842 | 146-147 | R12991 | 60-61   | R13213 | 552-553 | R13339 | 612-613 |
| R12577 | 474-475 | R12705 | 436-437 |         | R12843 | 146-147 | R12992 | 60-61   | R13214 | 552-553 | R13340 | 612-613 |
|        | 716-717 | R12707 | 434-435 |         | R12844 | 146-147 | R12993 | 538-539 | R13215 | 526-527 | R13344 | 578-579 |
| R12578 | 696-697 | R12709 | 436-437 |         | R12845 | 146-147 | R12994 | 538-539 | R13216 | 526-527 | R13345 | 18-19   |
| R12579 | 698-699 | R12710 | 436-437 |         | R12846 | 76-77   | R12995 | 502-503 | R13217 | 526-527 | R13346 | 540-541 |
| R12580 | 700-701 | R12711 | 436-437 |         | R12848 | 156-157 | R12996 | 502-503 | R13218 | 522-523 | R13347 | 540-541 |
| R12581 | 192-193 | R12712 | 436-437 |         | R12849 | 156-157 | R12997 | 502-503 | R13221 | 384-385 | R13348 | 506-507 |
| R12583 | 604-605 | R12713 | 436-437 |         | R12850 | 156-157 | R12998 | 232-233 | R13222 | 384-385 | R13349 | 506-507 |
| R12584 | 604-605 | R12716 | 394-395 |         | R12851 | 156-157 | R12999 | 228-229 | R13223 | 384-385 | R13350 | 540-541 |
| R12585 | 242-243 | R12717 | 394-395 |         | R12852 | 78-79   | R13000 | 504-505 | R13224 | 384-385 | R13351 | 540-541 |
|        | 684-685 | R12718 | 82-83   |         | R12853 | 78-79   | R13048 | 70-71   | R13225 | 384-385 | R13352 | 508-509 |
| R12587 | 252-253 | R12719 | 82-83   |         | R12854 | 438-439 | R13049 | 584-585 | R13226 | 384-385 | R13353 | 508-509 |
| R12589 | 238-239 | R12720 | 82-83   |         | R12856 | 438-439 | R13050 | 584-585 | R13227 | 384-385 | R13360 | 24-25   |
| R12590 | 246-247 | R12721 | 82-83   |         | R12857 | 438-439 | R13051 | 582-583 | R13228 | 384-385 | R13361 | 140-141 |
| R12591 | 246-247 | R12722 | 462-463 |         | R12858 | 438-439 | R13052 | 582-583 | R13229 | 384-385 | R13362 | 140-141 |
| R12592 | 242-243 | R12729 | 136-137 |         | R12870 | 450-451 | R13053 | 454-455 | R13230 | 384-385 | R13363 | 126-127 |
| R12593 | 242-243 | R12730 | 136-137 |         | R12871 | 450-451 | R13054 | 454-455 | R13231 | 384-385 |        | 312-313 |
| R12595 | 252-253 | R12731 | 136-137 |         | R12872 | 450-451 | R13055 | 454-455 | R13232 | 384-385 |        | 126-127 |
| R12596 | 238-239 | R12732 | 136-137 |         | R12875 | 450-451 | R13056 | 454-455 | R13233 | 384-385 | R13364 | 312-313 |
| R12598 | 248-249 | R12733 | 136-137 |         | R12876 | 450-451 | R13058 | 454-455 | R13234 | 384-385 | R13365 | 62-63   |
| R12599 | 248-249 | R12734 | 136-137 |         | R12877 |         |        |         |        |         |        |         |

|        |                |        |                |        |                |        |                |        |                |        |                |
|--------|----------------|--------|----------------|--------|----------------|--------|----------------|--------|----------------|--------|----------------|
| R13374 | <b>294-295</b> | R13554 | <b>188-189</b> | R13652 | <b>42-43</b>   | R13776 | <b>500-501</b> | R13897 | <b>64-65</b>   | R14004 | <b>408-409</b> |
| R13375 | <b>294-295</b> |        | <b>258-259</b> | R13653 | <b>358-359</b> | R13777 | <b>62-63</b>   | R13898 | <b>64-65</b>   | R14005 | <b>412-413</b> |
| R13376 | <b>294-295</b> | R13555 | <b>184-185</b> | R13654 | <b>642-643</b> | R13778 | <b>62-63</b>   | R13899 | <b>64-65</b>   | R14006 | <b>414-415</b> |
| R13377 | <b>208-209</b> |        | <b>258-259</b> | R13658 | <b>42-43</b>   | R13779 | <b>312-313</b> | R13900 | <b>64-65</b>   | R14007 | <b>410-411</b> |
|        | <b>274-275</b> | R13556 | <b>310-311</b> | R13660 | <b>368-369</b> | R13780 | <b>312-313</b> | R13901 | <b>310-311</b> | R14008 | <b>410-411</b> |
| R13378 | <b>208-209</b> | R13558 | <b>344-345</b> | R13661 | <b>220-221</b> | R13781 | <b>536-537</b> | R13902 | <b>310-311</b> | R14009 | <b>410-411</b> |
|        | <b>274-275</b> | R13559 | <b>682-683</b> |        | <b>276-277</b> | R13782 | <b>536-537</b> | R13903 | <b>342-343</b> | R14010 | <b>414-415</b> |
| R13379 | <b>208-209</b> | R13560 | <b>682-683</b> | R13662 | <b>220-221</b> | R13783 | <b>500-501</b> | R13904 | <b>342-343</b> | R14011 | <b>406-407</b> |
|        | <b>274-275</b> | R13561 | <b>680-681</b> |        | <b>276-277</b> | R13784 | <b>500-501</b> | R13905 | <b>342-343</b> | R14012 | <b>412-413</b> |
| R13380 | <b>208-209</b> | R13562 | <b>246-247</b> | R13663 | <b>328-329</b> | R13788 | <b>14-15</b>   | R13906 | <b>342-343</b> | R14013 | <b>412-413</b> |
|        | <b>274-275</b> |        | <b>670-671</b> | R13664 | <b>328-329</b> | R13789 | <b>116-117</b> | R13907 | <b>338-339</b> | R14014 | <b>414-415</b> |
| R13391 | <b>446-447</b> | R13563 | <b>658-659</b> | R13665 | <b>366-367</b> | R13790 | <b>118-119</b> | R13908 | <b>58-59</b>   | R14015 | <b>414-415</b> |
| R13394 | <b>356-357</b> | R13564 | <b>658-659</b> | R13666 | <b>366-367</b> | R13791 | <b>116-117</b> | R13909 | <b>58-59</b>   | R14016 | <b>406-407</b> |
| R13397 | <b>24-25</b>   | R13565 | <b>658-659</b> | R13667 | <b>394-395</b> | R13792 | <b>228-229</b> | R13910 | <b>58-59</b>   | R14017 | <b>408-409</b> |
| R13398 | <b>28-29</b>   | R13566 | <b>464-465</b> | R13668 | <b>394-395</b> |        | <b>678-679</b> | R13911 | <b>58-59</b>   | R14019 | <b>50-51</b>   |
| R13401 | <b>452-453</b> |        | <b>722-723</b> | R13676 | <b>96-97</b>   | R13793 | <b>678-679</b> | R13912 | <b>58-59</b>   | R14020 | <b>50-51</b>   |
| R13402 | <b>452-453</b> | R13567 | <b>464-465</b> | R13677 | <b>96-97</b>   | R13794 | <b>678-679</b> | R13913 | <b>58-59</b>   | R14021 | <b>50-51</b>   |
| R13404 | <b>150-151</b> |        | <b>722-723</b> | R13678 | <b>96-97</b>   | R13795 | <b>120-121</b> | R13914 | <b>284-285</b> | R14022 | <b>50-51</b>   |
| R13405 | <b>150-151</b> | R13568 | <b>700-701</b> | R13679 | <b>96-97</b>   | R13796 | <b>646-647</b> |        | <b>300-301</b> | R14023 | <b>50-51</b>   |
| R13417 | <b>578-579</b> | R13569 | <b>658-659</b> | R13680 | <b>98-99</b>   | R13797 | <b>646-647</b> | R13915 | <b>284-285</b> | R14024 | <b>50-51</b>   |
| R13418 | <b>28-29</b>   | R13570 | <b>148-149</b> | R13681 | <b>98-99</b>   | R13807 | <b>122-123</b> |        | <b>300-301</b> | R14025 | <b>50-51</b>   |
| R13419 | <b>28-29</b>   | R13571 | <b>278-279</b> | R13682 | <b>104-105</b> | R13808 | <b>122-123</b> | R13916 | <b>300-301</b> | R14026 | <b>50-51</b>   |
| R13423 | <b>280-281</b> | R13582 | <b>448-449</b> | R13683 | <b>104-105</b> | R13809 | <b>616-617</b> | R13917 | <b>300-301</b> | R14027 | <b>50-51</b>   |
| R13429 | <b>346-347</b> | R13583 | <b>448-449</b> | R13684 | <b>104-105</b> | R13814 | <b>516-517</b> | R13918 | <b>290-291</b> | R14028 | <b>50-51</b>   |
| R13430 | <b>396-397</b> | R13584 | <b>448-449</b> |        | <b>124-125</b> | R13815 | <b>518-519</b> | R13919 | <b>290-291</b> | R14029 | <b>50-51</b>   |
| R13432 | <b>396-397</b> | R13585 | <b>448-449</b> | R13685 | <b>104-105</b> | R13816 | <b>528-529</b> | R13920 | <b>290-291</b> | R14030 | <b>50-51</b>   |
| R13433 | <b>228-229</b> | R13586 | <b>448-449</b> |        | <b>124-125</b> | R13817 | <b>528-529</b> | R13921 | <b>290-291</b> | R14031 | <b>340-341</b> |
| R13435 | <b>230-231</b> | R13587 | <b>448-449</b> | R13686 | <b>102-103</b> | R13818 | <b>528-529</b> | R13922 | <b>290-291</b> | R14032 | <b>340-341</b> |
| R13436 | <b>236-237</b> | R13588 | <b>448-449</b> | R13687 | <b>102-103</b> | R13819 | <b>524-525</b> | R13923 | <b>290-291</b> | R14033 | <b>326-327</b> |
| R13437 | <b>614-615</b> | R13589 | <b>448-449</b> | R13688 | <b>102-103</b> | R13821 | <b>50-51</b>   | R13924 | <b>290-291</b> | R14034 | <b>332-333</b> |
| R13438 | <b>120-121</b> | R13590 | <b>448-449</b> | R13689 | <b>106-107</b> | R13822 | <b>50-51</b>   | R13925 | <b>290-291</b> | R14035 | <b>328-329</b> |
| R13439 | <b>724-725</b> | R13591 | <b>448-449</b> | R13690 | <b>106-107</b> | R13823 | <b>50-51</b>   | R13926 | <b>540-541</b> | R14036 | <b>334-335</b> |
| R13441 | <b>454-455</b> | R13598 | <b>400-401</b> | R13691 | <b>206-207</b> | R13824 | <b>44-45</b>   | R13927 | <b>540-541</b> | R14037 | <b>326-327</b> |
| R13442 | <b>454-455</b> | R13599 | <b>400-401</b> |        | <b>272-273</b> | R13825 | <b>44-45</b>   | R13928 | <b>508-509</b> | R14038 | <b>326-327</b> |
| R13444 | <b>152-153</b> | R13600 | <b>400-401</b> | R13692 | <b>36-37</b>   | R13826 | <b>40-41</b>   | R13929 | <b>508-509</b> | R14039 | <b>328-329</b> |
| R13445 | <b>152-153</b> | R13601 | <b>400-401</b> | R13693 | <b>106-107</b> | R13827 | <b>40-41</b>   | R13930 | <b>632-633</b> | R14040 | <b>322-323</b> |
| R13446 | <b>538-539</b> | R13602 | <b>392-393</b> | R13694 | <b>106-107</b> | R13841 | <b>576-577</b> | R13931 | <b>632-633</b> | R14041 | <b>322-323</b> |
| R13450 | <b>110-111</b> | R13603 | <b>404-405</b> | R13695 | <b>206-207</b> | R13842 | <b>238-239</b> | R13932 | <b>632-633</b> | R14042 | <b>324-325</b> |
|        | <b>648-649</b> | R13604 | <b>398-399</b> |        | <b>272-273</b> | R13843 | <b>148-149</b> | R13933 | <b>264-265</b> | R14043 | <b>352-353</b> |
| R13451 | <b>110-111</b> | R13605 | <b>404-405</b> | R13696 | <b>206-207</b> | R13844 | <b>148-149</b> |        | <b>706-707</b> | R14044 | <b>352-353</b> |
|        | <b>648-649</b> | R13606 | <b>110-111</b> |        | <b>272-273</b> | R13848 | <b>538-539</b> | R13934 | <b>264-265</b> | R14045 | <b>352-353</b> |
| R13452 | <b>110-111</b> | R13607 | <b>110-111</b> | R13697 | <b>114-115</b> | R13849 | <b>538-539</b> |        | <b>706-707</b> | R14046 | <b>352-353</b> |
|        | <b>648-649</b> | R13608 | <b>110-111</b> | R13698 | <b>114-115</b> | R13851 | <b>158-159</b> | R13935 | <b>264-265</b> | R14047 | <b>332-333</b> |
| R13471 | <b>132-133</b> | R13609 | <b>250-251</b> | R13703 | <b>206-207</b> | R13852 | <b>188-189</b> |        | <b>706-707</b> | R14048 | <b>332-333</b> |
| R13472 | <b>132-133</b> | R13609 | <b>674-675</b> | R13703 | <b>272-273</b> |        | <b>258-259</b> | R13936 | <b>642-643</b> | R14049 | <b>332-333</b> |
| R13473 | <b>132-133</b> | R13610 | <b>250-251</b> | R13704 | <b>206-207</b> | R13853 | <b>186-187</b> | R13938 | <b>158-159</b> | R14050 | <b>332-333</b> |
| R13474 | <b>132-133</b> |        | <b>674-675</b> |        | <b>272-273</b> |        | <b>258-259</b> | R13939 | <b>158-159</b> | R14051 | <b>332-333</b> |
| R13475 | <b>132-133</b> | R13611 | <b>250-251</b> | R13707 | <b>162-163</b> | R13854 | <b>518-519</b> | R13940 | <b>60-61</b>   | R14052 | <b>332-333</b> |
| R13476 | <b>132-133</b> |        | <b>674-675</b> | R13708 | <b>162-163</b> | R13855 | <b>516-517</b> | R13941 | <b>282-283</b> | R14053 | <b>332-333</b> |
| R13479 | <b>146-147</b> | R13612 | <b>278-279</b> | R13709 | <b>80-81</b>   | R13856 | <b>516-517</b> | R13942 | <b>368-369</b> | R14054 | <b>332-333</b> |
| R13480 | <b>146-147</b> | R13613 | <b>278-279</b> | R13710 | <b>80-81</b>   | R13857 | <b>526-527</b> | R13954 | <b>466-467</b> | R14055 | <b>334-335</b> |
| R13481 | <b>146-147</b> | R13614 | <b>630-631</b> | R13711 | <b>162-163</b> | R13858 | <b>526-527</b> | R13955 | <b>466-467</b> | R14056 | <b>334-335</b> |
| R13482 | <b>146-147</b> | R13615 | <b>254-255</b> | R13712 | <b>162-163</b> | R13859 | <b>524-525</b> | R13956 | <b>466-467</b> | R14057 | <b>334-335</b> |
| R13483 | <b>146-147</b> |        | <b>656-657</b> | R13713 | <b>80-81</b>   | R13860 | <b>550-551</b> | R13957 | <b>466-467</b> | R14058 | <b>334-335</b> |
| R13484 | <b>146-147</b> |        | <b>672-673</b> | R13714 | <b>80-81</b>   | R13861 | <b>550-551</b> | R13958 | <b>474-475</b> | R14059 | <b>334-335</b> |
| R13485 | <b>146-147</b> | R13616 | <b>254-255</b> | R13720 | <b>552-553</b> | R13862 | <b>552-553</b> | R13963 | <b>548-549</b> | R14060 | <b>334-335</b> |
| R13486 | <b>146-147</b> |        | <b>656-657</b> | R13721 | <b>520-521</b> | R13863 | <b>552-553</b> | R13964 | <b>546-547</b> | R14061 | <b>334-335</b> |
| R13487 | <b>156-157</b> | R13616 | <b>672-673</b> | R13726 | <b>554-555</b> | R13864 | <b>564-565</b> | R13965 | <b>546-547</b> | R14062 | <b>334-335</b> |
| R13488 | <b>156-157</b> | R13617 | <b>704-705</b> | R13730 | <b>154-155</b> | R13865 | <b>564-565</b> | R13966 | <b>546-547</b> | R14063 | <b>336-337</b> |
| R13489 | <b>156-157</b> | R13618 | <b>704-705</b> | R13731 | <b>496-497</b> | R13866 | <b>564-565</b> | R13967 | <b>514-515</b> | R14064 | <b>336-337</b> |
| R13490 | <b>156-157</b> | R13619 | <b>600-661</b> | R13732 | <b>496-497</b> | R13867 | <b>128-129</b> | R13968 | <b>514-515</b> | R14065 | <b>354-355</b> |
| R13492 | <b>606-607</b> | R13620 | <b>476-477</b> | R13735 | <b>186-187</b> |        | <b>314-315</b> | R13969 | <b>514-515</b> | R14066 | <b>354-355</b> |
| R13493 | <b>606-607</b> |        | <b>718-719</b> |        | <b>258-259</b> | R13868 | <b>128-129</b> | R13970 | <b>554-555</b> | R14067 | <b>356-357</b> |
| R13494 | <b>606-607</b> | R13621 | <b>476-477</b> | R13736 | <b>240-241</b> |        | <b>314-315</b> | R13971 | <b>554-555</b> | R14068 | <b>356-357</b> |
| R13495 | <b>606-607</b> | R13621 | <b>718-719</b> |        | <b>676-677</b> | R13869 | <b>128-129</b> | R13972 | <b>554-555</b> | R14069 | <b>362-363</b> |
| R13496 | <b>130-131</b> | R13622 | <b>648-649</b> | R13737 | <b>240-241</b> |        | <b>314-315</b> | R13973 | <b>554-555</b> | R14070 | <b>362-363</b> |
| R13497 | <b>542-543</b> | R13623 | <b>648-649</b> |        | <b>676-677</b> | R13870 | <b>542-543</b> | R13974 | <b>522-523</b> | R14071 | <b>362-363</b> |
| R13498 | <b>542-543</b> | R13624 | <b>650-651</b> | R13738 | <b>240-241</b> | R13871 | <b>542-543</b> | R13975 | <b>522-523</b> | R14072 | <b>362-363</b> |
| R13499 | <b>506-507</b> | R13625 | <b>650-651</b> |        | <b>676-677</b> | R13872 | <b>542-543</b> | R13976 | <b>522-523</b> | R14073 | <b>360-361</b> |
| R13500 | <b>506-507</b> | R13626 | <b>112-113</b> | R13739 | <b>240-241</b> | R13873 | <b>506-507</b> | R13977 | <b>522-523</b> | R14074 | <b>364-365</b> |
| R13501 | <b>130-131</b> |        | <b>648-649</b> |        | <b>676-677</b> | R13874 | <b>506-507</b> | R13978 | <b>548-549</b> | R14075 | <b>364-365</b> |
| R13502 | <b>682-683</b> | R13627 | <b>112-113</b> | R13742 | <b>98-99</b>   | R13875 | <b>506-507</b> | R13979 | <b>520-521</b> | R14076 | <b>364-365</b> |
| R13503 | <b>650-651</b> |        | <b>648-649</b> | R13743 | <b>148-149</b> | R13876 | <b>128-129</b> | R13980 | <b>552-553</b> | R14077 | <b>364-365</b> |
| R13504 | <b>668-669</b> | R13628 | <b>112-113</b> | R13745 | <b>36-37</b>   |        | <b>314-315</b> | R13981 | <b>552-553</b> | R14078 | <b>364-365</b> |
| R13505 | <b>644-645</b> |        | <b>650-651</b> | R13746 | <b>36-37</b>   |        | <b>506-507</b> | R13982 | <b>552-553</b> | R14079 | <b>362-363</b> |
| R13507 | <b>644-645</b> | R13629 | <b>112-113</b> | R13747 | <b>36-37</b>   |        | <b>542-543</b> | R13983 | <b>526-527</b> | R14080 | <b>362-363</b> |
| R13508 | <b>644-645</b> |        | <b>650-651</b> | R13748 | <b>28-29</b>   | R13877 | <b>128-129</b> | R13984 | <b>526-527</b> | R14081 | <b>362-363</b> |
| R13509 | <b>644-645</b> | R13630 | <b>698-699</b> | R13752 | <b>40-41</b>   |        |                |        |                |        |                |



 **rendl light studio**

[www.rendl.it](http://www.rendl.it)