

 rendi
light
studio



CATÁLOGO DE LUMINARIAS

2024



CONTENIDO

GLOSARIO	4-5
LÁMPARAS COLGANTES	6-87
LÁMPARAS DE TECHO	88-175
LÁMPARAS DE PARED	176-265
FOCOS	266-317
LÁMPARAS DE MESA	318-347
LÁMPARAS DE PIE	348-371
LUCES EMPOTRADAS	372-481
SISTEMA DE CARRILES 3F	482-531
SISTEMA DE CARRILES 1F	532-555
TIRAS LED	556-565
PANTALLAS Y ACCESORIOS	566-619
LUMINARIAS DE EXTERIOR	620-725
FUENTES DE LUZ	726-743
INTERRUPTORES Y ACCESORIOS	744-751
LISTA ALFABÉTICA DE LUCES	752-755
IDENTIFICACIÓN DE ÍNDICE	756-759

GLOSARIO



PRODUCTO

Descripción

PRODUCTO

230 V/350 mA LED... Información técnica

IDENTIFICACIÓN DEL ARTÍCULO Color / material **PRECIO** ➔



↑ 50

● Ø40

● **LED**

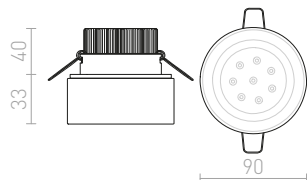

- incluye
- no está incluido
- ↑ profundidad necesaria (en mm)
- diámetro del agujero redondo (en mm)
- ▣ tamaño del agujero cuadrado (en mm)
- ∠ 20° ángulo de inclinación
- ∠ 90° ángulo de rotación
- ▭ 44 dimensión (en mm)
- NEW nuevo
- % productos a un precio preferencial
- ➔ discontinuado, stock en liquidación

Los valores de la luminaria especificada son valores nominales generados por la fuente de luz. El flujo luminoso será menor debido a la pérdida causada por la parte óptica de la fijación.

Los valores especificados del consumo de energía son los valores nominales del consumo por la fuente de luz. El consumo de energía total del accesorio aumentará por la pérdida causada por la resistencia eléctrica.

El fabricante se reserva el derecho de realizar cambios en los parámetros de productos individuales durante la validez del catálogo.

% y ➔ – productos están en cantidad limitada y su disponibilidad no está garantizada durante la validez del catálogo.

GARANTÍA EXTENDIDA

La garantía estándar proporcionada a todos los clientes es de DOS AÑOS. Se puede solicitar una GARANTÍA EXTENDIDA CONTRACTUAL para un proyecto individual más grande. Está determinada por el tipo de mercancía, el volumen y la duración de la garantía. Solicite una oferta.

EXCLUSIÓN DE RESPONSABILIDAD

Los cambios están sujetos a previo aviso. Los errores y las omisiones están reservados. Siempre asegúrese de estar usando la última edición. Al utilizar otras fuentes de luz o accesorios que no sean los recomendados por nosotros, no podemos garantizar la funcionalidad de la lámpara.

IP REQUERIDO

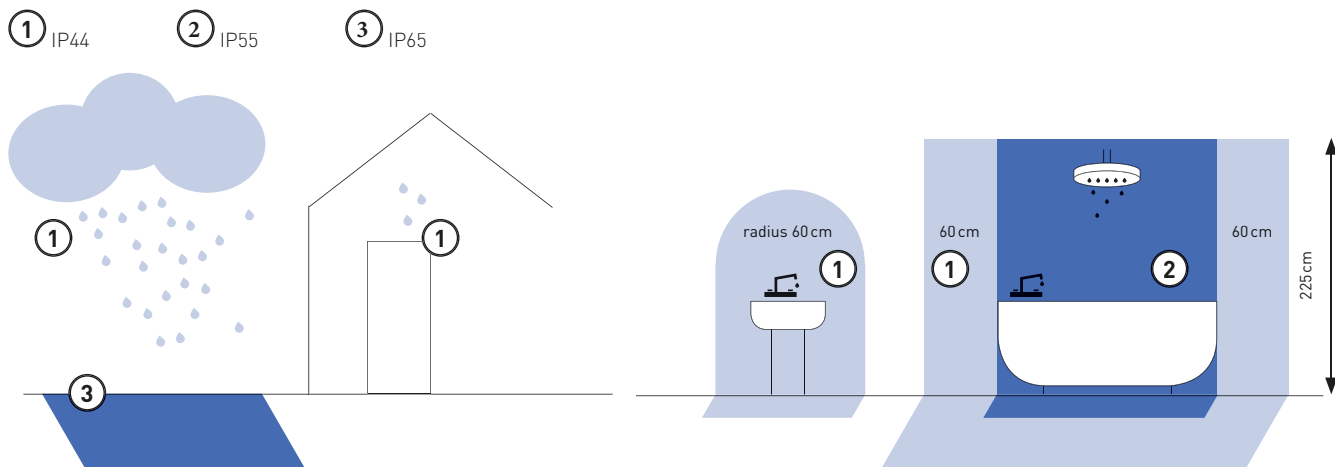

INSTALACIÓN DE LUMINARIAS DE EXTERIOR EMPOTRABLES

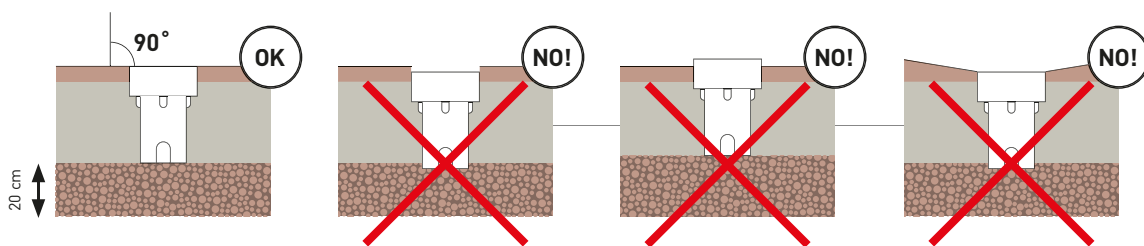

LED Integrado

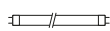

T5 Tubo fluorescente

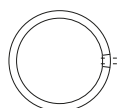

2GX13 Tubo fluorescente



G11841

Fuente recomendada, más información en la categoría Fuentes de luz.



Transformador no atenuable.



regulable

Luz con transformador TRIAC atenuable.

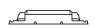

regulación opcional

Por un costo adicional, la luz se puede suministrar con un transformador atenuable.



G13002

Transformador recomendado, más información en la categoría de Accesorios.



Interruptor de palanca



Interruptor de palanca



Interruptor en el cable



Interruptor de empuje



Interruptor de tirar



Interruptor eléctrico



Interruptor de timbre



Interruptor de timbre



PIR

Sensor PIR, sensor de infrarrojos de movimiento.



MW

Sensor MW, sensor de microondas de movimiento.



1800K → 3000K
DIMM TO WARM

DIMM TO WARM, control de temperatura de color de la luz.



LÁMPARAS COLGANTES

DECORATIVAS	14-31
MÚLTIPLE	32-33
VIDRIO	34-51
POSICIONABLES	52-57
METÁLICO	58-73
CIRCULAR, TÉCNICAS	74-77
ANGULAR, TÉCNICAS	78-81
OBLONGO	82-85
INDUSTRIAL	86-87

COLGANTES DECORATIVAS



FLORIDA
14-15



HEIDI
14-15



RADICAL
14-15

14-31



ELLA
14-15



CAMINO
16-17



BURTON
16-17



ILUSIA
16-17



JACK RC
16-17



ESME 76
18-19



NANCY III
18-19



TUTTI
18-19



FRUTTI
18-19



ENCAMBRE
20-21



CONFETTI
20-21



COCO
20-21



ZALA
22-23



RARA
22-23



EZRA 40
22-23



CLANK
22-23



BUCKY 40
24-25



VESCO
24-25



JAMAICA 34
24-25



POLLOCK
24-25



ESPLANADE
26-27



ICAR
26-27



CHOUPEPTE
26-27



AMICI
26-27



FIATLUX 41/24
28-29



FANCY 35/25
28-29



FANCY 50/30
28-29



GLAMOUR 35/20
28-29



LALO 55
30-31



LALO 40
30-31



LOPE 80
30-31



AINO 40
30-31

COLGANTES MÚLTIPLE

32-33



ASTRAL
32-33



ASTROMET VII
32-33



CINDY VI
32-33

COLGANTES VIDRIO

34-51



BEAU MONDE 25
34-35



BEAU MONDE 30
34-35



BEAU MONDE 35
34-35



LUNA 20
36-37



LUNA 25
36-37



LUNA 30
36-37



BOLLY 17
36-37



LUNEA 30
38-39



LUNEA 40
38-39



LUNEA 50
38-39



JULIETTA 16
40-41



JULIETTA 31
40-41



BABU NEW 22
40-41



BELLINI L E14
42-43



BELLINI M LED
42-43



AZRIA
42-43



CORONA
42-43



PULIRE CON
44-45



PULIRE RD
44-45



COROA NEW 28
44-45



SANSSOUCI I
46-47



SANSSOUCI I
46-47



GARNISH
46-47



EIGHT
46-47



TOMBA
46-47



ESTRA V
48-49



ESTRA I
48-49



GIFT I
48-49



DADOS NEW
50-51



LIZ NEW
50-51



DADOS III 60
50-51



DADOS III 80
50-51



LIZ III 60
50-51



LIZ III 80
50-51

COLGANTES POSICIONABLES

52-57



BROADWAY
52-53



LEVITA
52-53



BROADWAY
54-55



MADISON C
54-55



LOYD LED I
56-57



LOYD E27 I
56-57



LOYD E27 III
56-57

COLGANTES METÁLICO

58-73



GIULIA 12
58-59



GIULIA 20
58-59



GIULIA 40
58-59



MAVRO
60-61



RIGA 28
60-61



STIG
60-61



BOGARD
62-63



BELENOS
62-63



OPTIMUS
62-63



AGNETA
64-65



COPA
64-65



DESTY I
64-65



ARAQ
64-65



ASTON 28
66-67



ASTON 30
66-67



BLONDIE 25
66-67



MARGO
66-67



MONROE 30
68-69



MONROE 40
68-69



SINTRA 40
68-69



SINTRA 30
68-69



BABADES I
70-71



BABADES IV
70-71



CARISSIMA 25
70-71



CARISSIMA 40
70-71



GOLDIE 36
72-73



GOLDIE 46
72-73



MERYLYN 48
72-73

COLGANTES CIRCULAR, TÉCNICAS



MEZZO 40
74-75



MEZZO 60
74-75



MEZZO 40/60
74-75

74-77



MEZZO 80
74-75



MEZZO 80
74-75



MONETA
76-77



LARISA R 30
76-77



CASSABLANCA 40
76-77



ASTERI
76-77

COLGANTES ANGULAR, TÉCNICAS



MENSA SQ 48
78-79



MENSA RC
78-79



LARISA SQ 30
78-79

78-81



STRUCTURAL LED 20x20
80-81



STRUCTURAL LED 40x40
80-81



STRUCTURAL LED 55x55
80-81

COLGANTES OBLONGO



PESANTE 35
82-83



PESANTE 75
82-83



TRIDENT PRO 120
84-85

82-85



TRIDENT PRO 150
84-85



TRIDENT PRO
84-85

COLGANTES INDUSTRIAL



MEGALOS PRO 26
86-87



MEGALOS PRO 30
86-87



MEGALOS PRO 35
86-87

86-87



ELLA

Luminaria colgante LED hecha de yeso, con casquillo E27 y base de techo hecha de metal laqueado en blanco. La lámpara se puede pintar con pintura para interiores.

ELLA COLGANTE

230 V LED E27 15 W

R13788 yeso

€ 120

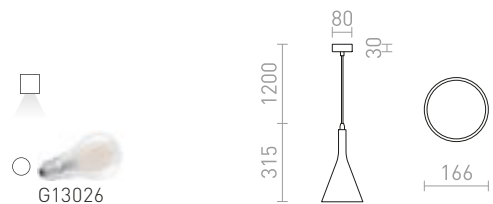



FLORIDA

Lámpara colgante de cerámica texturizada para fuentes de luz E27.

FLORIDA COLGANTE

230 V E27 28 W

R13298 cerámico

€ 98

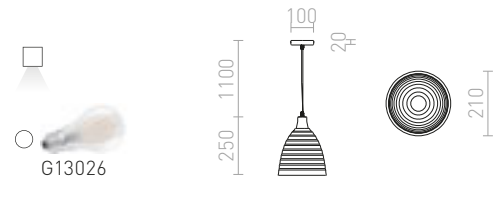

RADICAL

Lámpara colgante hecha de hormigón macizo con un hilo y un cable separados, para fuentes de luz E27.

RADICAL COLGANTE

230 V E27 28 W

R12416 hormigón

€ 158

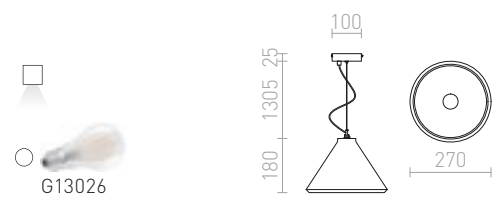

HEIDI

Luminaria colgante de techo cónica hecha de hormigón con tapa de madera para casquillo E27.

HEIDI COLGANTE

230 V E27 28 W

R12380 hormigón/madera

€ 98

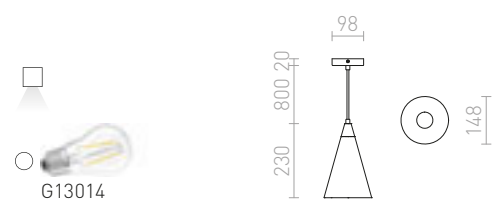



ILUSIA

Colgante con pantalla de alambre y cable textil, para ser utilizada con una fuente de luz E27 adecuada.

ILUSIA COLGANTE

230 V E27 42 W

R13892 negro

€ 68 **NEW**

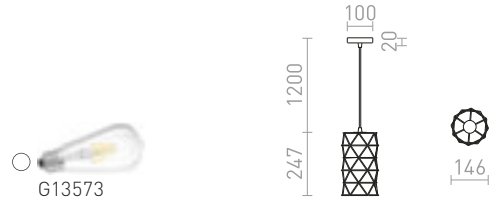

BURTON

Luminaria colgante hecha de hormigón con pantalla metálica para bombilla con casquillo E27.

BURTON COLGANTE

230 V E27 42 W

R12931 hormigón

€ 88

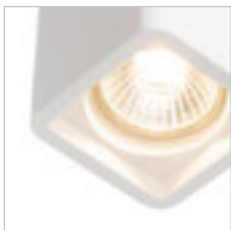

JACK

Luminaria colgante de yeso, con casquillo GU10 y base en el techo de metal lacado blanco. La lámpara se puede colorear con pintura para interiores.

JACK RC COLGANTE

230 V GU10 35 W

R11676 yeso

€ 68 **%**

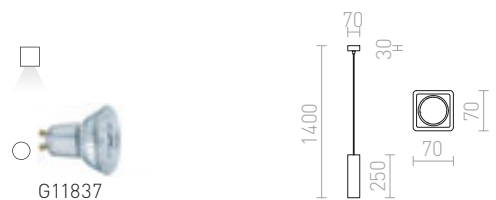



CAMINO

Lámpara colgante de forma cilíndrica para bombillas con casquillo E27. Cada base tiene un patrón único.

CAMINO COLGANTE

230 V E27 28 W

R13296 teraso decor

€ 88

R13297 cemento

€ 88

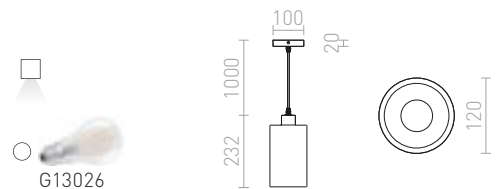



TUTTI

Lámpara colgante con una pantalla cónica que ilumina hacia abajo, con casquillo E27.

TUTTI COLGANTE

230 V E27 15 W

R13289 naranja/cerámico

€ 58 →

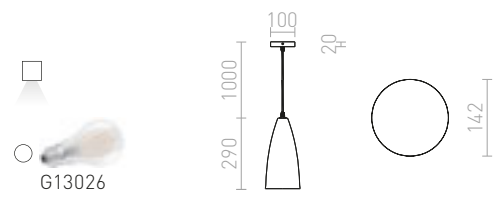

FRUTTI

Lámpara colgante para fuentes de luz E27.

FRUTTI COLGANTE

230 V E27 28 W

R13290 verde/cerámico

€ 48 →

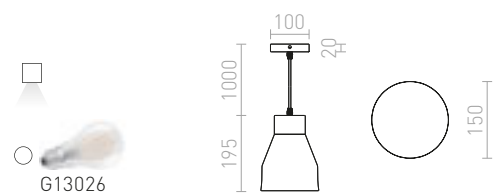



NANCY

Lámpara colgante con una base y tres pantallas textiles, para tres fuentes de luz E14.

NANCY III COLGANTE

230 V E14 3x11 W

R13345 blanco/rojo

€ 48 %

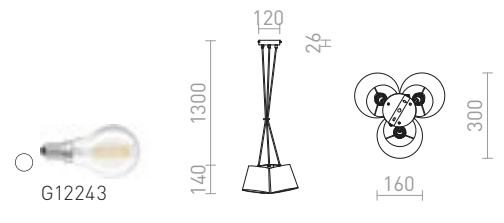

ESME

Lámpara colgante con una pantalla cónica oblonga blanca y color naranja en el interior.

ESME 76 COLGANTE

230 V E27 28 W

R13276 blanco/naranja

€ 68 %

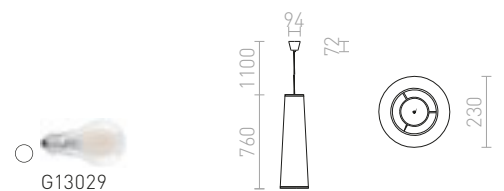



ENCOMBRE

Luminaria decorativa colgante hecha de pétalos de plástico en tres variantes de color. Se suministra desmontado, requiere ensamblaje.

ENCOMBRE COLGANTE

230 V E27 42 W

R12381 PVC blanco

€ 138

R12382 hoja de cromo

€ 158

R12383 hoja de cobre

€ 178

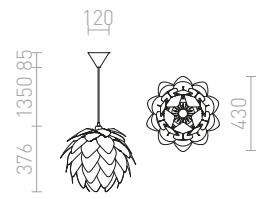

COCO

Luminaria colgante decorativa hecha de elementos de plástico con un diseño de capullo de rosa. Se suministra desmontado, requiere ensamblaje.

COCO COLGANTE

230 V E27 28 W

R12384 PVC blanco

€ 220

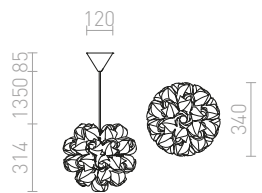



CONFETTI

Lámpara divertida con capas de grandes lentejuelas hechas de hoja cromada. Se suministra desmontado, requiere ensamblaje.

CONFETTI COLGANTE

230 V E27 28 W

R13285 hoja de cromo

€ 88

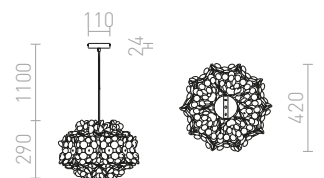
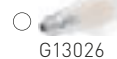



ZALA

Lámpara colgante con tiras decorativas de plástico. Se suministra desmontado, requiere ensamblaje.

ZALA COLGANTE

230 V E27 15 W

R13315 PVC blanco/negro

€ 48 %

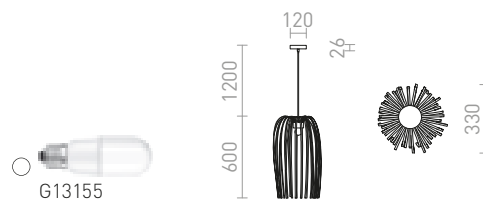

RARA

Lámpara colgante con tiras decorativas de plástico. Se suministra desmontado, requiere ensamblaje.

RARA COLGANTE

230 V E27 15 W

R13316 PVC blanco/negro

€ 48 %

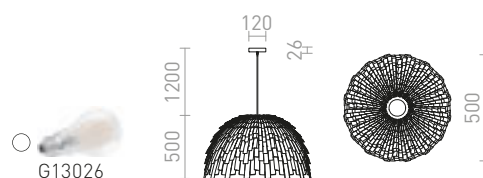



CLANK

Lámpara colgante con tiras decorativas de plástico. Se suministra desmontado, requiere ensamblaje.

CLANK COLGANTE

230 V E27 15 W

R13321 PVC blanco/negro

€ 68 %

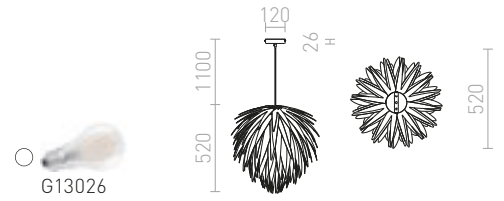

EZRA

Luminaria colgante redonda de plástico con perforación decorativa. Se suministra desmontado, requiere ensamblaje.

EZRA 40 COLGANTE

230 V E27 15 W

R13319 PVC blanco/gris

€ 48 %

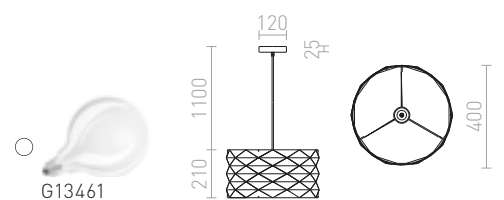



JAMAICA

Pantalla trenzada hecha de material natural, de forma cónica.

JAMAICA 34 COLGANTE

230 V E27 15 W

R13397 natural

€ 78 →

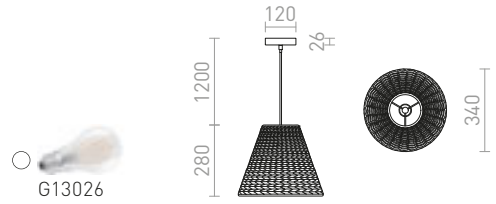

POLLOCK

Pantalla textil colgante con un difusor gris empotrado.

POLLOCK COLGANTE

230 V E27 28 W

R13280 blanco/gris luminoso

€ 68 →

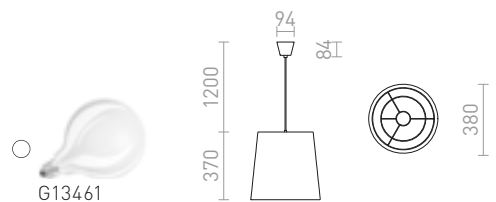



VESCO

Luminaria colgante con pantalla de metal lacado.

VESCO COLGANTE

230 V E27 42 W

R10536 negro

€ 129 %

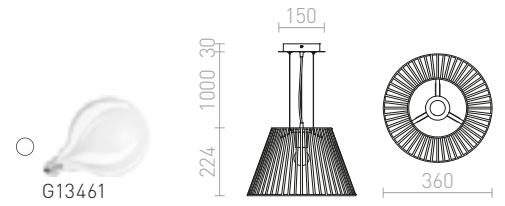

BUCKY

Lámpara colgante de metal con diseño de textura abrochada.

BUCKY 40 COLGANTE

230 V E27 28 W

R13360 blanco/gris/metal

€ 129 %

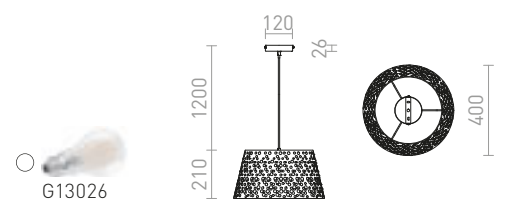



ESPLANADE

Lámpara colgante con doble pantalla textil.

ESPLANADE COLGANTE

230 V E27 42 W

R12483 negro transparente/blanco/cromo

€ 335



G13029

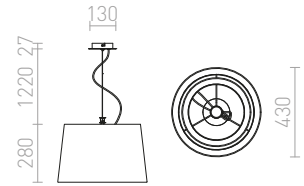



AMICI

Luminaria colgante con pantalla de silicona.

AMICI COLGANTE DE SILICONA

230 V E27 42 W

R10620 verde

€ 10.50 %

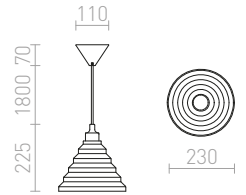

CHOUETTE

Luminaria textil colgante con accesorio de madera para bombilla LED con casquillo E27.

CHOUETTE COLGANTE

230 V E27 15 W

R13650 gris negruzco/textil/madera

€ 120

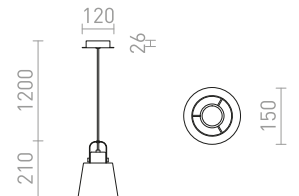

ICAR

Luminaria colgante minimalista con pantalla textil.

ICAR COLGANTE

230 V E27 15 W

R12418 negro/oro

€ 120

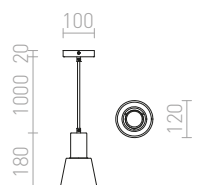



FIATLUX

Pantalla negra colgante de bambú.

FIATLUX 41/24 COLGANTE

230 V E27 15 W

R13398 negro/bambú

€ 88 

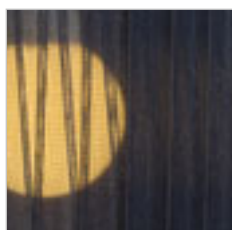
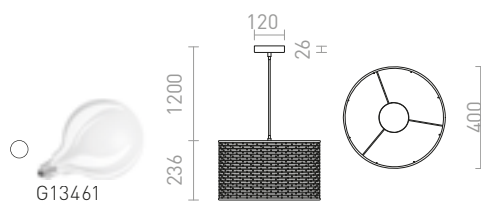

GLAMOUR

Lámpara colgante con pantallas de cintas negras.

GLAMOUR 35/20 COLGANTE

230 V E27 28 W

R13271 negro

€ 48 

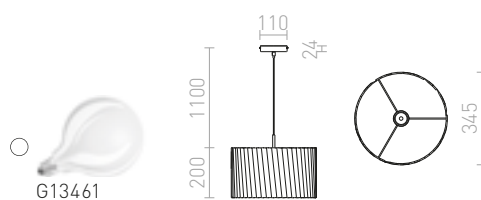



FANCY

Lámpara colgante decorativa con una pantalla de lámina de color cromo. Cuando se enciende se vuelve semitransparente y cuando se apaga tiene una superficie reflectante.

FANCY 35/25 COLGANTE

230 V E27 15 W

R13418 hoja de cromo

€ 120

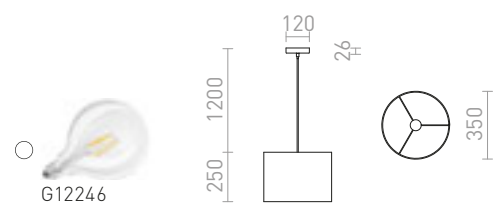

FANCY 50/30 COLGANTE

230 V E27 20 W

R13419 hoja de cromo

€ 150

R13748 hoja de humo

€ 178

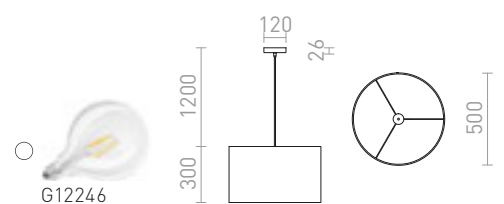



AINO

Lámpara colgante con una pantalla de patrón de punto gris.

AINO 40 COLGANTE

230 V E27 28 W

R13275 gris/cromo

€ 129 %

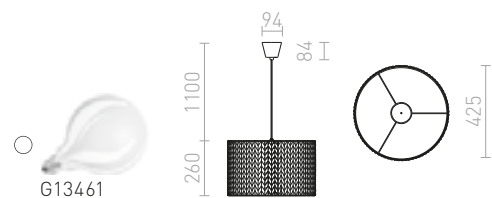



LALO

Luminaria colgante con pantalla finamente plisada en color blanco crema. La lámpara es para tres fuentes de luz con casquillo E27. Las fuentes están cubiertas con un difusor de acrílico mate.

LALO 40 COLGANTE

230 V E27 3x42 W

R10605 blanco crema/níquel mate

€ 215 %

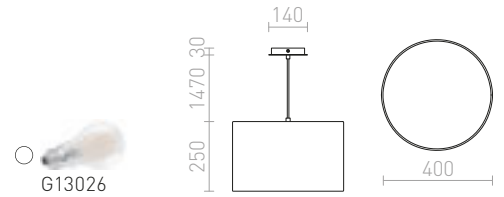

LALO 55 COLGANTE

230 V E27 3x42 W

R10540 blanco crema/níquel mate

€ 229 %

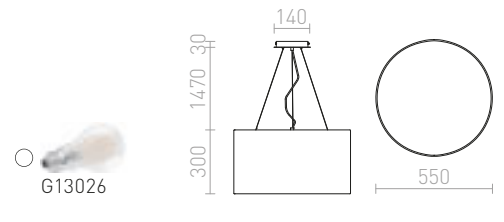

LOPE

Luminaria colgante con pantalla finamente plisada en negro para cuatro bombillas con casquillo E27. Las fuentes de luz están cubiertas con un difusor acrílico mate.

LOPE 80 COLGANTE

230 V E27 4x42 W

R10539 negro/níquel mate

€ 120 %

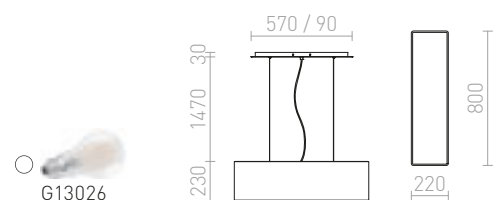

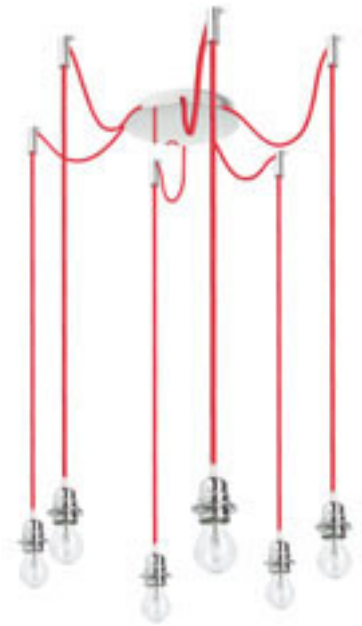

Otras variantes del set de suspensión **KOMBIX** se pueden encontrar en la categoría **Pantallas y accesorios**.



CINDY

Luminaria colgante con base de techo central y seis bisagras individuales con casquillo E27. Las bisagras están equipadas con soportes de techo que se pueden colocar a una distancia individual de la base. Longitud total del cable 2 m.

CINDY VI COLGANTE

230 V E27 6x42 W

R12054 negro

€ 238

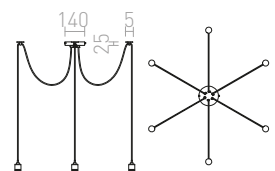



ASTRAL

Luminaria colgante de diseño elegante, con pantalla de vidrio bicolor. Las pantallas se pueden ensamblar de diferentes formas. El anillo decorativo se utiliza para ajustar el ángulo de inclinación de la pantalla.

ASTRAL COLGANTE

230 V/12 V G4 10x20 W

R10513 cristal cromado/vidrio transparente € 560

R11706 vidrio tintado de cobre/vidrio transparente € 645

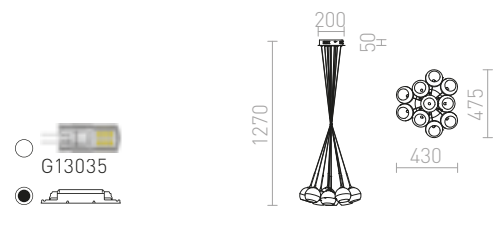

ASTROMET

Luminaria colgante con siete pantallas de cromo que están unidas a una sola base de techo. Lleva casquillos E27.

ASTROMET VII COLGANTE

230 V E27 7x42 W

R11761 cromo

€ 320

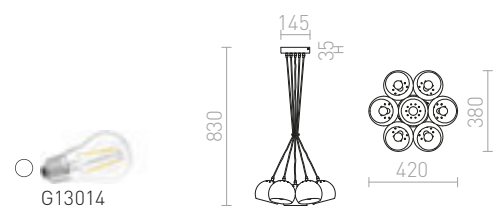





BEAU MONDE

Luminaria colgante con pantalla de vidrio soplado a mano. La apariencia de espejo en la pantalla se logra mediante un método especial en el que se aplica una fina capa de metal no transparente al vidrio. Es apropiada para fuentes de luz de bajo consumo mediante el uso del casquillo E27. Las pequeñas burbujas en la superficie de la pantalla son el resultado del proceso de fabricación, no de un defecto.

BEAU MONDE 25 COLGANTE

230 V E27 25 W

R10517 vidrio tintado de cobre

€ 198

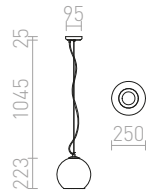

BEAU MONDE

Luminaria colgante con pantalla de vidrio soplado a mano. La apariencia de espejo en la pantalla se logra mediante un método especial en el que se aplica una fina capa de metal al vidrio. La superficie de la pantalla tiene la apariencia de un espejo cuando la luz está apagada y es transparente cuando está encendida. Es apropiada para fuentes de luz de bajo consumo mediante el uso del casquillo E27. Las pequeñas burbujas en la superficie de la pantalla son el resultado del proceso de fabricación, no de un defecto.

BEAU MONDE 30 COLGANTE

230 V E27 25 W

R10518 cristal cromado

€ 278

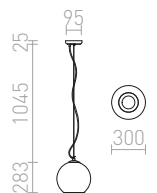

BEAU MONDE

Luminaria colgante con pantalla de vidrio soplado a mano. La apariencia de espejo en la pantalla se logra mediante un método especial en el que se aplica una fina capa de metal al vidrio. La parte inferior de la pantalla es de vidrio claro. Es apropiada para fuentes de luz de bajo consumo mediante el uso del casquillo E27. Las pequeñas burbujas en la superficie de la pantalla son el resultado del proceso de fabricación, no de un defecto.

BEAU MONDE 35 COLGANTE

230 V E27 25 W

R10516 cristal cromado/vidrio transparente

€ 320

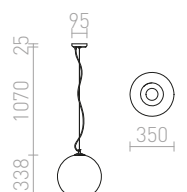



IP44

BOLLY

Luminaria colgante con cristal opalino y accesorios cromados. Adecuada para ambientes húmedos.

BOLLY 17 COLGANTE
230 V LED E27 15 W IP44

R13692 vidrio opal/cromo

€ 178

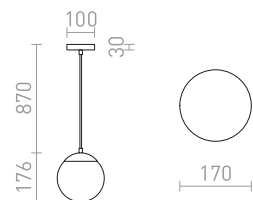



LUNA

Luminaria colgante con cristal opalino con accesorios cromados y cable transparente.

LUNA 20 COLGANTE

230 V LED E27 15 W

R13745 vidrio opal/cromo

€ 120

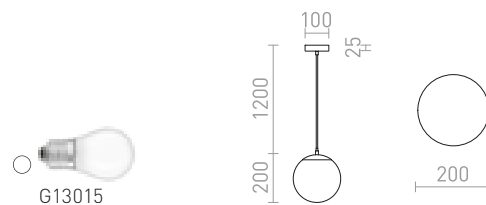

LUNA 25 COLGANTE

230 V LED E27 15 W

R13746 vidrio opal/cromo

€ 150

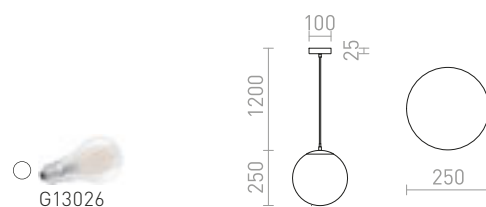

LUNA 30 COLGANTE

230 V LED E27 15 W

R13747 vidrio opal/cromo

€ 198

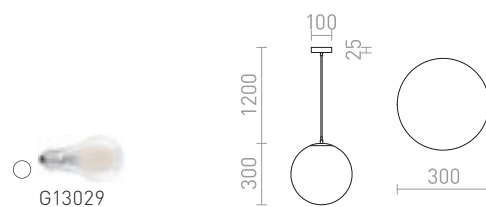



LUNEA

Luminaria colgante con esfera de vidrio triplex, de color opal mate. El cable de suspensión se encuentra separado del suministro eléctrico. Cable transparente, accesorios cromados.

LUNEA 30 COLGANTE TRIPLEX

230 V E27 70 W

R10478 vidrio opal

€ 178

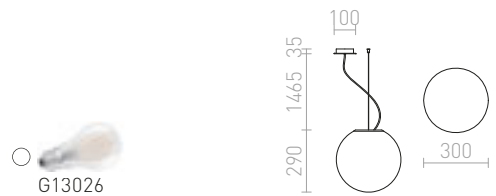

LUNEA 40 COLGANTE TRIPLEX

230 V E27 70 W

R10479 vidrio opal

€ 320

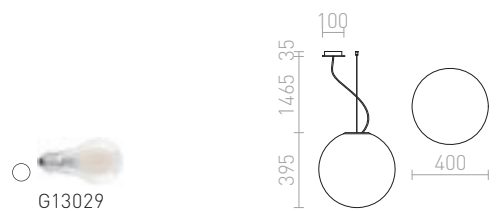

LUNEA 50 COLGANTE TRIPLEX

230 V E27 100 W

R11715 vidrio opal

€ 450

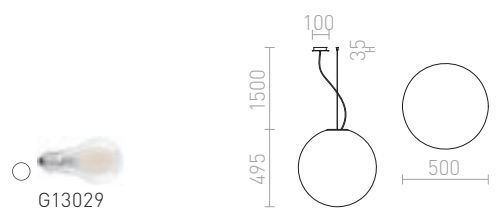







BABU NEW

Luminaria colgante con pantalla de vidrio en dos variantes de color. Tiene una base de techo cromada.

BABU NEW 22 COLGANTE

230 V E27 53 W

R13826 vidrio transparente/cromo

€ 178

R13827 vidrio opal/cromo

€ 178

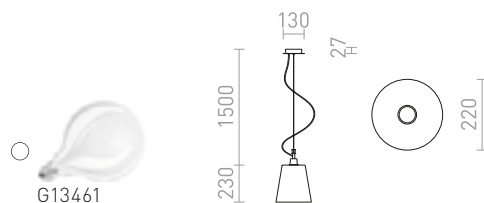

JULIETTA

Luminaria colgante de diseño con cristal cilíndrico opal. Elementos laqueados metálicos, cable textil negro.

JULIETTA 16 COLGANTE

230 V E27 20 W

R13752 vidrio opal/negro

€ 120

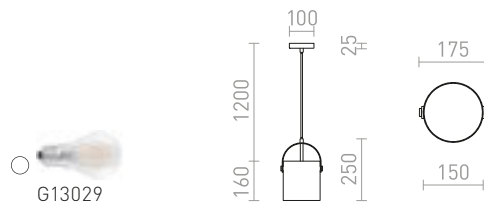

JULIETTA 31 COLGANTE

230 V E27 20 W

R13753 vidrio opal/negro

€ 158

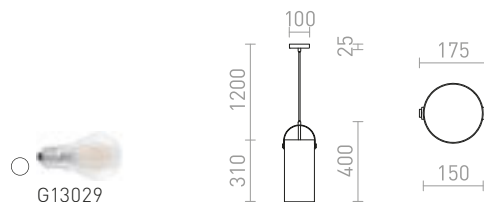



BELLINI

Luminaria colgante de cristal con accesorios laqueados para bombilla LED con casquillo E14.

BELLINI L E14 COLGANTE

230 V E14 15 W

R13658 blanco/vidrio transparente

€ 178

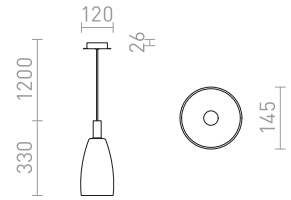

BELLINI

Luminaria LED colgante de cristal en un diseño. Apto para iluminar barras e islas de cocina.

BELLINI M LED COLGANTE

230 V LED 5 W $\angle 30^\circ$ 3000 K 475 lm Ra 80

R13652 negro/vidrio de color humo

€ 198

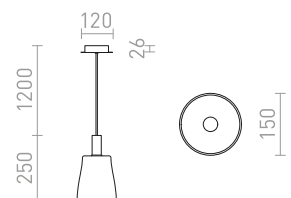



AZRIA

Elegante lámpara colgante con accesorios estructurados de cristal y cromo.

AZRIA COLGANTE

230 V G9 25 W

R12056 vidrio de color humo

€ 78 %

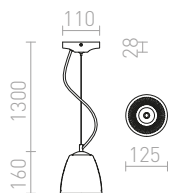

CORONA

Luminaria colgante con cristal sólido y estructurado. El vidrio está cromado en ambos lados. Cuando está encendida, la fuente de luz es parcialmente visible a través de la pantalla.

CORONA COLGANTE

230 V E27 42 W

R12055 cristal cromado

€ 215 %

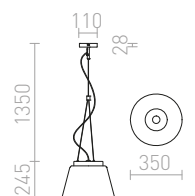



COROA NEW 28

Luminaria colgante con pantalla de vidrio en dos variantes de color. Tiene una base de techo cromada.

COROA NEW 28 COLGANTE

230 V E27 53 W

R13824 vidrio opal/cromo

€ 220

R13825 negro/cromo

€ 258

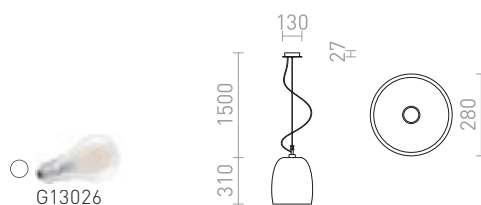

PULIRE

Lámpara retro colgante de vidrio teñido para lámpara con casquillo E14.

PULIRE CON COLGANTE

230 V E14 28 W

R12663 vidrio opal/madera/cromo

€ 98



PULIRE RD COLGANTE

230 V E14 28 W

R12664 vidrio opal/madera/cromo

€ 98







SANSSOUCI

Luminaria colgante con pantalla de vidrio. La superficie de la pantalla se refleja mientras la luz está apagada y es parcialmente transparente mientras está encendida.

SANSSOUCI I COLGANTE

230 V E27 42 W

R10511 vidrio tintado de cobre

€ 98 →



G13111

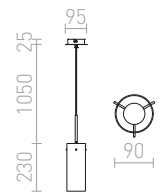

SANSSOUCI I COLGANTE

230 V E27 42 W

R10509 cristal cromado

€ 98 →



G13111

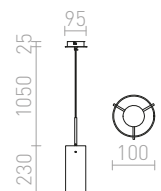



GARNISH

Luminaria colgante con base cromada y pantalla de cristal transparente. La pantalla de cristal está cerrada en la parte inferior. Puede ser decorada de manera complementaria.

GARNISH COLGANTE

230 V GU10 9 W

R11756 vidrio transparente/cromo

€ 138



G11837

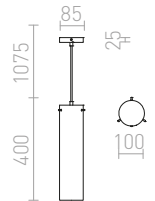

EIGHT

Luminaria colgante con pantalla de cristal opalino y detalles cromados.

EIGHT COLGANTE

230 V E27 28 W

R10493 vidrio opal/cromo

€ 129



G13155

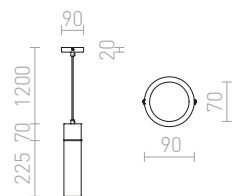

TOMBA

Luminaria colgante cilíndrica de cristal, con accesorios cromados para tres lámparas fluorescentes lineales.

TOMBA COLGANTE

230 V G5 3x21 W

R10501 vidrio opal/cromo

€ 278

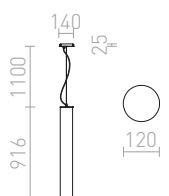
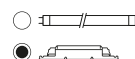





GIFT

Luminaria colgante con pantalla de cristal claro texturizado y con accesorios cromados.

GIFT I COLGANTE

230 V E14 42 W

R10510 vidrio transparente/cromo

€ 88

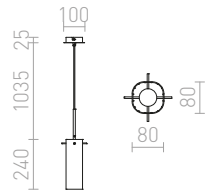

ESTRA

Luminaria LED colgante con focos decorativos de aluminio rodeados de un cristal transparente.

ESTRA V COLGANTE

230 V LED 5x5 W 3000 K 2000 lm Ra 81

R11678 blanco/vidrio transparente

€ 335

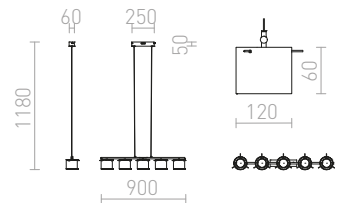
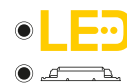

ESTRA I COLGANTE

230 V LED 5 W 3000 K 400 lm Ra 81

R11679 blanco/vidrio transparente

€ 78

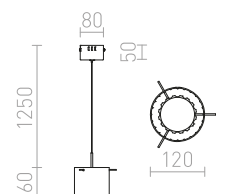



LIZ NEW

Luminaria colgante con pantalla de vidrio en dos variantes de color.

LIZ NEW COLGANTE

230 V E27 28 W

R13822 vidrio opal/cromo

€ 98

R13823 negro/cromo

€ 98

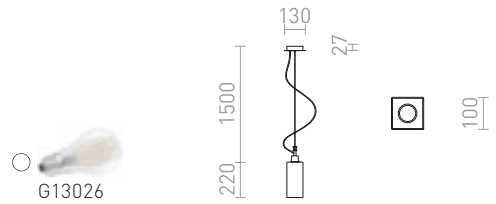

LIZ NEW

Lámpara colgante lineal con pantallas de cristal para fuentes de luz LED E27. Apta para colocar encima de una mesa de comedor.

LIZ III 60 COLGANTE

230 V LED E27 3x11 W

R14023 vidrio opal/níquel mate

€ 150 NEW

R14024 vidrio opal/cromo

€ 150 NEW

R14025 negro/vidrio/níquel mate

€ 158 NEW

R14026 negro/vidrio/cromo

€ 158 NEW

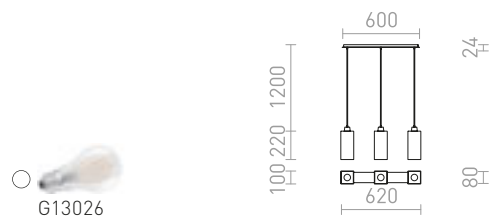

LIZ III 80 COLGANTE

230 V LED E27 3x11 W

R14027 vidrio opal/níquel mate

€ 178 NEW

R14028 vidrio opal/cromo

€ 178 NEW

R14029 negro/vidrio/níquel mate

€ 178 NEW

R14030 negro/vidrio/cromo

€ 178 NEW

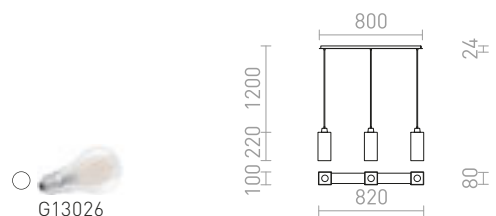

**DADOS NEW**

Luminaria colgante con pantalla de cristal opal. Base de techo cromada.

DADOS NEW COLGANTE

230 V E27 28 W

R13821 vidrio opal/cromo

€ 98

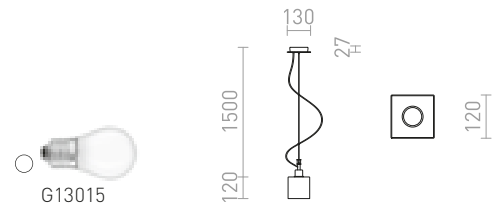
**DADOS NEW**

Lámpara colgante lineal con pantallas de cristal para fuentes de luz LED E27. Apta para colocar encima de una mesa de comedor.

DADOS III 60 COLGANTE

230 V LED E27 3x11 W

R14019 vidrio opal/níquel mate

€ 150

NEW

R14020 vidrio opal/cromo

€ 150

NEW

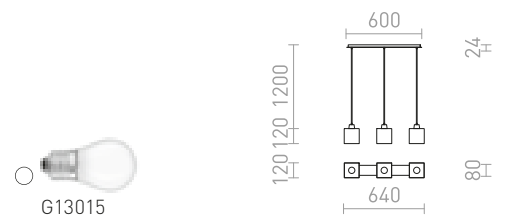
**DADOS III 80 COLGANTE**

230 V LED E27 3x11 W

R14021 vidrio opal/níquel mate

€ 178

NEW

R14022 vidrio opal/cromo

€ 178

NEW

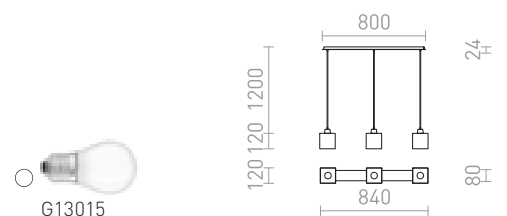



BROADWAY

Luminaria colgante con posibilidad de ajustar su altura. Adecuada para techos sin tomas de corriente. La pantalla está cubierta con tejido estructurado y el interruptor se encuentra en el cable de alimentación.

BROADWAY COLGANTE ADJUSTABLE

230 V E27 42 W

R11989 blanco/cromo

€ 178 %

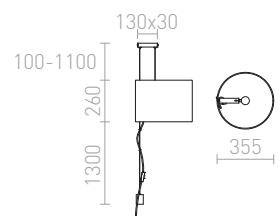

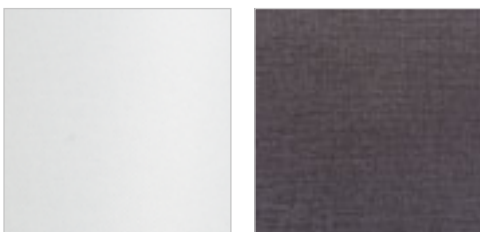

LEVITA

Lámpara colgante del textil stretch con pantalla en negro o blanco.

LEVITA COLGANTE AJUSTABLE

230 V E27 42 W

R12477 blanco/cromo

€ 420

R12478 negro/cromo

€ 420

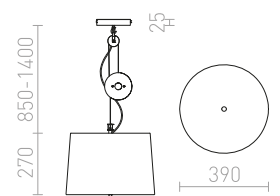



BROADWAY

Luminaria colgante con brazo ajustable en el eje del techo. La pantalla está cubierta con un tejido estructurado.

BROADWAY COLGANTE CON BRAZO

230 V E27 42 W

R11978 blanco/cromo

€ 720 %

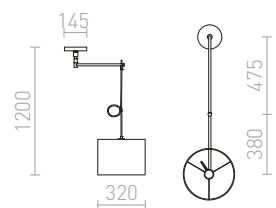
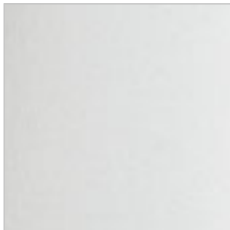

MADISON

Lámpara de techo con brazo regulable y pantalla textil.

MADISON C DE TECHO

230 V E27 42 W

R12479 blanco/cromo

€ 560 ➔

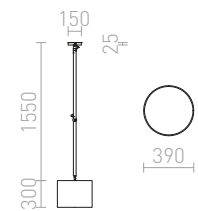





LOYD LED

Luminaria LED de techo flexible, ajuste flexible en todas las direcciones y pantalla textil.

LOYD LED I DE TECHO

230 V LED 4,5W 3000 K 280 lm Ra 80

R12932 negro/níquel mate

€ 88 %

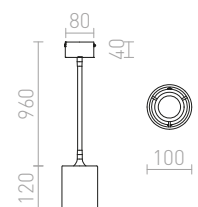



LOYD E27 I

Lámpara de techo flexible con funda de silicona, es regulable en todas las direcciones. Adecuada para ser usada con una bombilla decorativa o reflectora E27.

LOYD E27 I DE TECHO

230 V E27 28 W

R12933 gris beige

€ 88

R12934 negro

€ 88



G13461

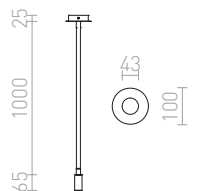

LOYD E27 III

Lámpara de techo flexible de tres luminarias con funda de silicona, es regulable en todas las direcciones. Adecuada para ser usada con una bombilla decorativa o reflectora E27.

LOYD E27 III DE TECHO

230 V E27 3x28 W

R12935 negro

€ 188



G12246

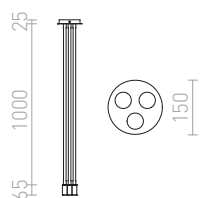





GIULIA

Lámpara colgante con pantalla de metal lacado y cable textil.

GIULIA 12 COLGANTE

230 V E27 40 W

R13908 blanco/cromo

€ 58 **NEW**

R13909 negro/dourado cinza/latón

€ 58 **NEW**

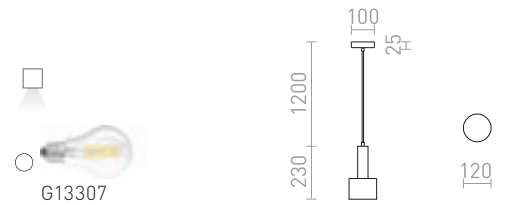

GIULIA 20 COLGANTE

230 V E27 40 W

R13910 blanco/cromo

€ 68 **NEW**

R13911 negro/dourado cinza/latón

€ 68 **NEW**

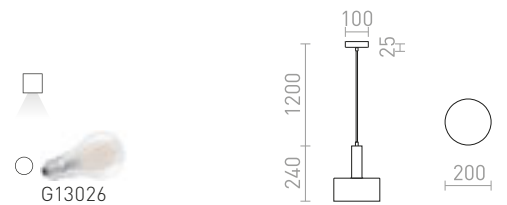

GIULIA 40 COLGANTE

230 V E27 40 W

R13912 blanco/cromo

€ 138 **NEW**

R13913 negro/dourado cinza/latón

€ 138 **NEW**

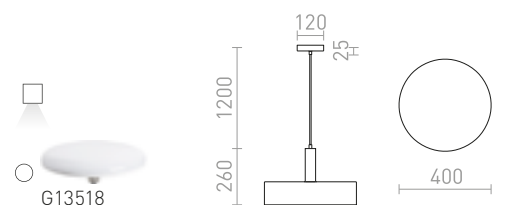



STIG

Elegante colgante LED apto para colgar sobre barras de bar o islas de cocina.

STIG COLGANTE

230 V LED 6,8 W $\angle 34^\circ$ 3000 K 466 lm Ra 80

R13940 negro

€ 88

NEW

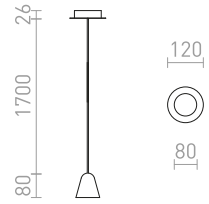
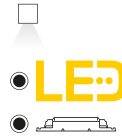

RIGA

Luminaria de techo LED.

RIGA 28 COLGANTE

230 V LED 6 W $\angle 38^\circ$ 3000 K 570 lm Ra 80

R12458 blanco

€ 98

R12459 negro

€ 98

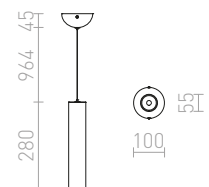
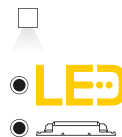

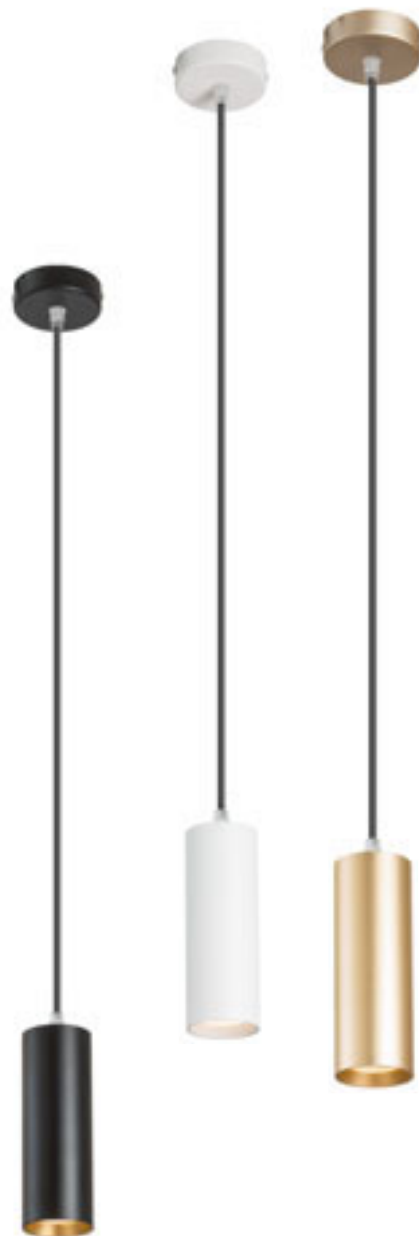

MAVRO

Elegante foco colgante tubular LED, adecuado para colgar sobre las barras de los bares e islas de cocina. Atenuación TRIAC.

MAVRO DIMM COLGANTE

230 V LED 12 W $\angle 38^\circ$ 3000 K 1020 lm Ra 80

R13182 blanco

€ 178

R13183 oro

€ 178

R13184 negro/oro

€ 178

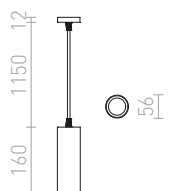

MAVRO

Elegante luminaria LED colgante cilíndrica, adecuada para colgar sobre mostradores de bares e islas de cocina.

MAVRO COLGANTE

230 V LED 12 W $\angle 38^\circ$ 3000 K 1020 lm Ra 80

R12990 blanco

€ 120

R12991 oro

€ 120

R12992 negro/oro

€ 120

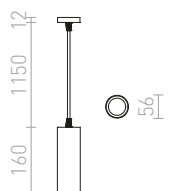
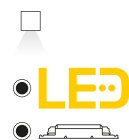



BOGARD

Lámpara colgante LED cilíndrica. La luminaria se puede extender ópticamente con R12495 y R12496.

BOGARD COLGANTE

230 V LED 5 W $\angle 40^\circ$ 3000 K 350 lm Ra 80

R12493 negro mate

€ 98

R12494 níquel mate

€ 78

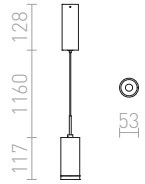
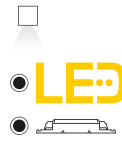

BOGARD

Extensión para lámparas colgantes Bogard R12493 y R12494.

BOGARD TUBO PARA LÁMPARA COLGANTE

R12495 negro mate

€ 13.50

R12496 níquel mate

€ 13.50

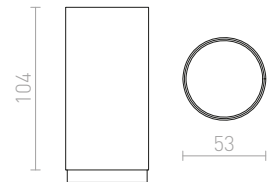

BELENOS

Foco colgante cilíndrico minimalista para fuentes de luz GU10 sobre base redonda. Los resortes del casquillo permiten el uso de fuentes de luz de varias longitudes.

BELENOS COLGANTE

230 V LED GU10 9 W

R13365 blanco

€ 58

R13366 negro

€ 58

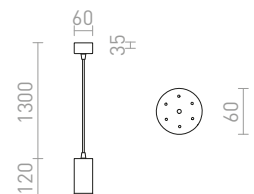



OPTIMUS

Luminaria colgante cilíndrica con posibilidad de ajustar el cono de luz mediante un sistema de zoom de 10-50°. La luminaria es apta para fuentes de luz LED con casquillo GU10. Utilice fuentes de luz con un ángulo de haz de 120° para evitar sombras no deseadas.

OPTIMUS COLGANTE

230 V LED GU10 9 W \angle 10-50°

R13777 blanco

€ 58

R13778 negro

€ 58

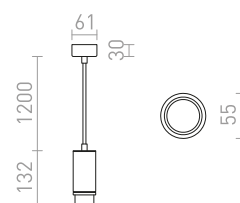



AGNETA

Colgante redondo de metal para ser utilizado con una fuente de luz E27 adecuada.

AGNETA COLGANTE

230 V E27 40 W

R13897 blanco

€ 58 NEW

R13898 negro

€ 58 NEW

R13899 latón cepillado

€ 88 NEW

R13900 cobre cepillado

€ 88 NEW

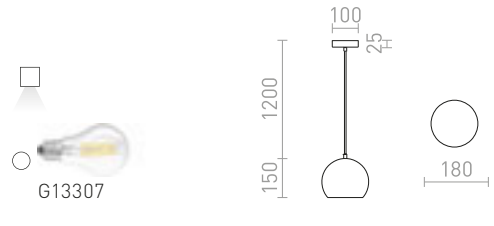

ARAQ

Colgante con casquillo de latón, cable textil y base lacada en negro. Para ser utilizada con una fuente de luz E27 decorativa adecuada.

ARAQ COLGANTE

230 V E27 42 W

R13891 latón cepillado/negro

€ 35 NEW

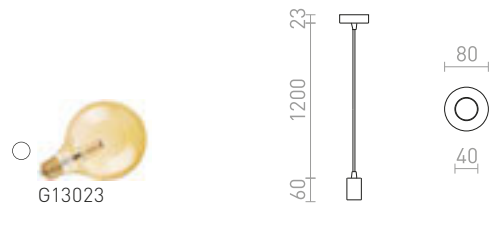

DESTY

Lámpara colgante con pantalla y base de techo en cromo o cobre. La versión de color cromo se suministra con un cable textil negro y la versión de cobre con un cable textil rojo.

DESTY I COLGANTE

230 V GU10 35 W

R12085 rojo/cobre

€ 78 →

R12086 negro/cromo

€ 78 →





COPA

Colgante con pantalla de vidrio, disponible en dos colores.

COPA COLGANTE

230 V E27 28 W

R11823 vidrio opal

€ 178

R11824 negro/vidrio

€ 178

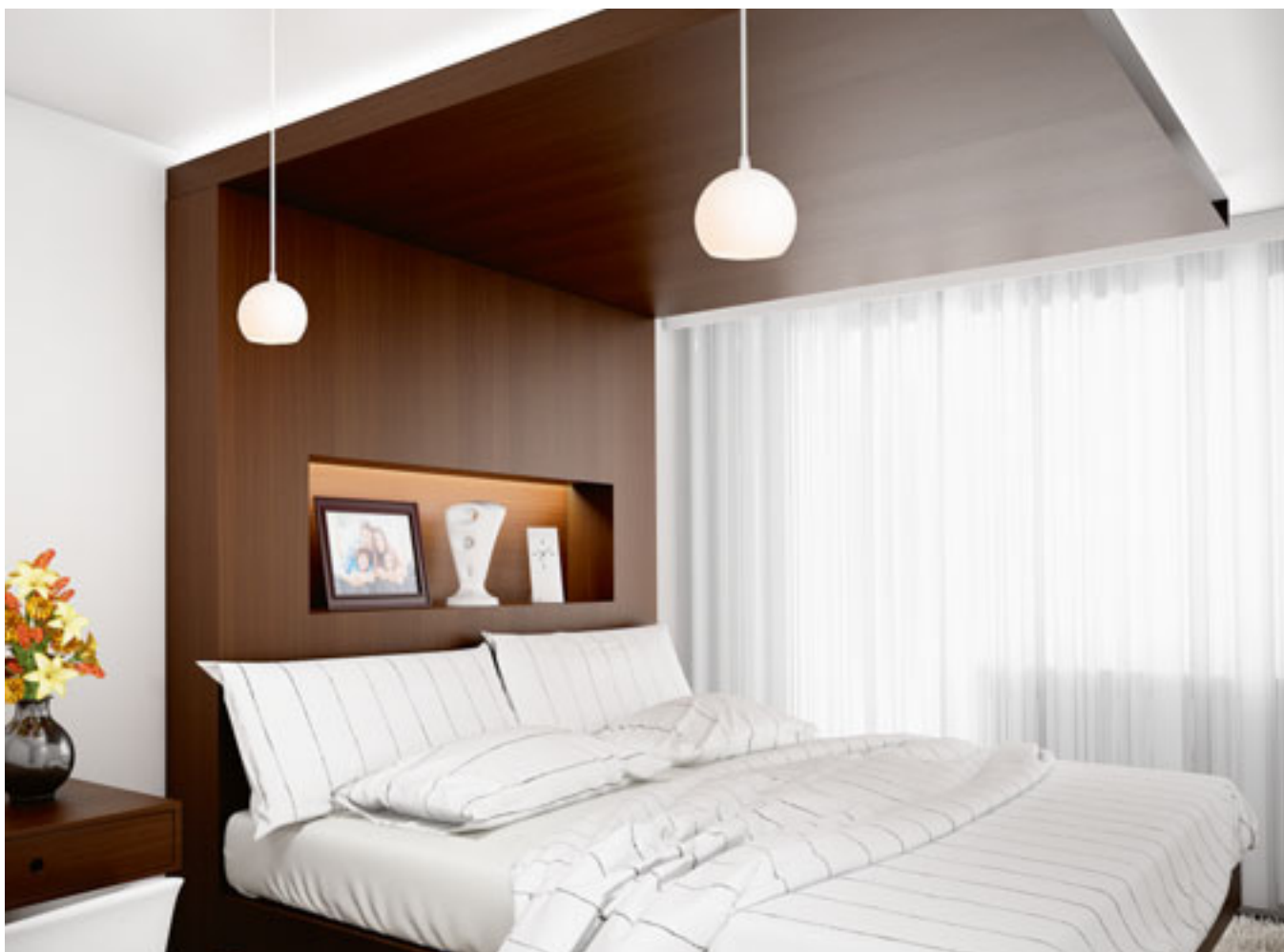
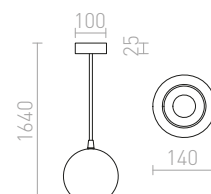



ASTON

Lámpara colgante de metal con cable transparente para fuente de luz con casquillo E27.

ASTON 28 COLGANTE

230 V E27 42 W

R10515 aluminio cepillado

€ 68 %

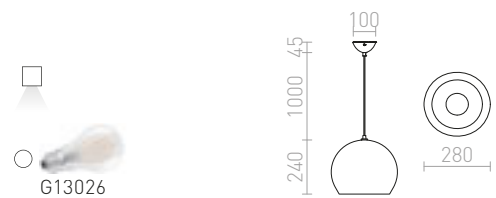

ASTON 30 COLGANTE

230 V E27 42 W

R12394 cromo

€ 98 %

R12395 cobre

€ 120 %

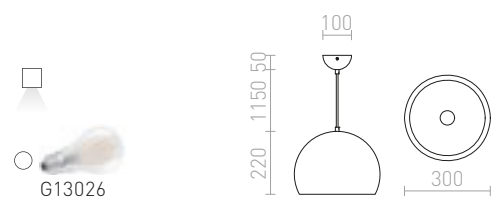



MARGO

Lámpara colgante cromada con luz LED incorporada que se dispersa a través de un difusor de acrílico esmerilado. El difusor tiene un marco de aluminio.

MARGO COLGANTE

230 V LED 7 W 3000 K 700 lm Ra 80

R10578 cromo

€ 48 %

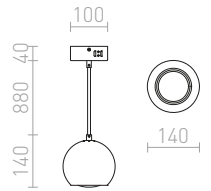

BLONDIE

Lámpara colgante con pantalla metálica abollada. El exterior de la pantalla es de color cobre y el interior está lacado en blanco. Incluye un cable de PVC negro y una base de techo de color cobre que combina con la lámpara.

BLONDIE 25 COLGANTE

230 V E27 42 W

R12057 cobre

€ 198



G13461

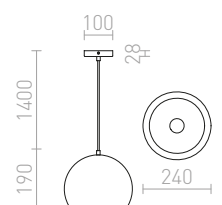





SINTRA

Lámpara colgante con pantalla de metal cromado, disponible en dos tamaños.

SINTRA 30 COLGANTE

230 V E27 42 W

R11698 cromo

€ 58 %

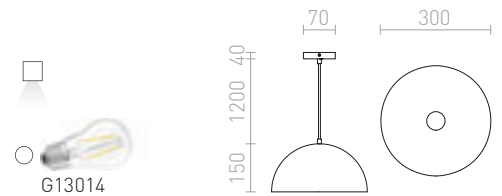

SINTRA 40 COLGANTE

230 V E27 42 W

R11699 cromo

€ 120 %

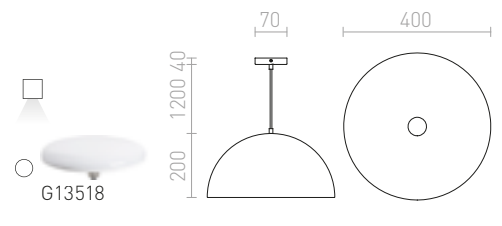

MONROE

Lámpara colgante con pantalla de metal, disponible en dos tamaños.

MONROE 30 COLGANTE

230 V E27 42 W

R11700 negro mate/blanco

€ 150

R12396 cobre

€ 120 %

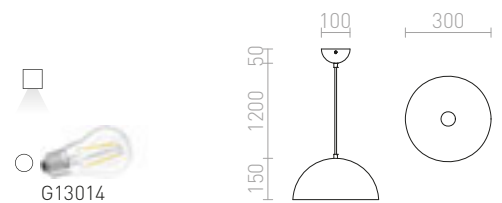

MONROE 40 COLGANTE

230 V E27 42 W

R11701 negro mate/blanco

€ 215

R11707 blanco brillante/blanco

€ 215

R12397 cobre

€ 150 %

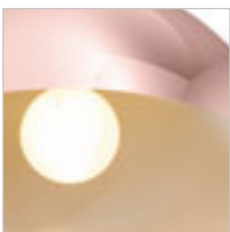
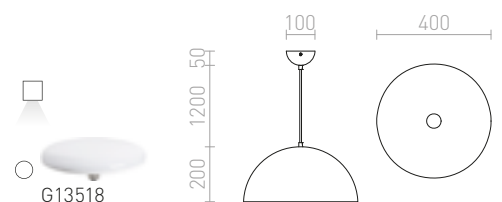



CARISSIMA

Lámpara colgante con pantalla metálica lacada o cromada. El interior de la pantalla es de color dorado o gris plateado.

CARISSIMA 25 COLGANTE

230 V E27 28 W

R11765 cromo

€ 58

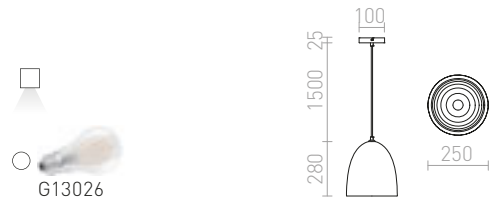

CARISSIMA 40 COLGANTE

230 V E27 42 W

R11766 negro mate/oro

€ 220

R13048 blanco mate/gris plata

€ 220

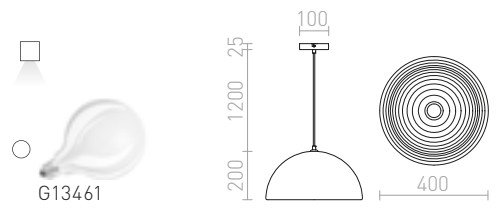

BABADES

Lámpara colgante con pantalla y base de techo de cromo o níquel mate. Incluye un cable textil negro.

BABADES IV COLGANTE

230 V GU10 4x35 W

R12083 cromo

€ 215

R12084 níquel mate

€ 215

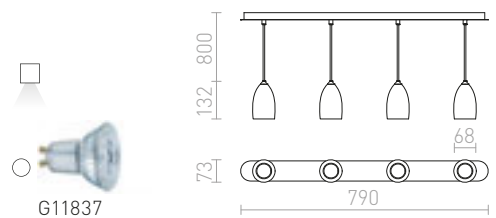

BABADES I COLGANTE

230 V GU10 35 W

R12081 cromo

€ 58

R12082 níquel mate

€ 58

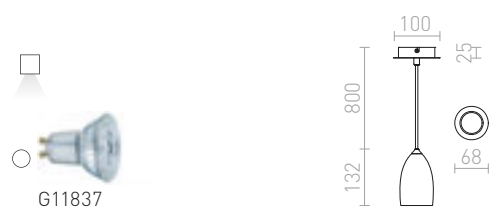







GOLDIE

Luminaria colgante de metal, disponible en tres variantes de color.

GOLDIE 36 COLGANTE

230 V E27 42 W

R11687 cromo

€ 120 %

R11688 negro/blanco

€ 178

R11689 blanco/blanco

€ 88 %

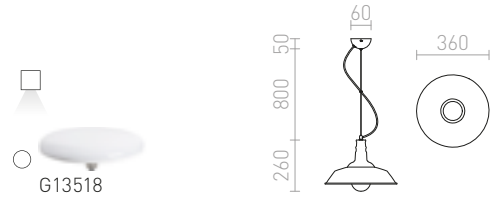

GOLDIE 46 COLGANTE

230 V E27 42 W

R11690 negro/blanco

€ 220

R11691 blanco/blanco

€ 215

R11692 cromo

€ 158 %

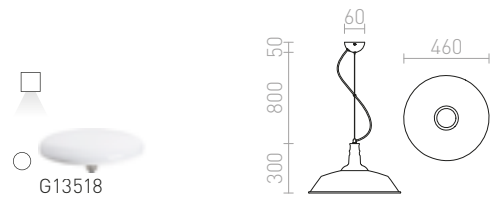

MERYLYN

Luminaria colgante cónica metálica para fuente de luz E27.

MERYLYN 48 COLGANTE

230 V E27 42 W

R12446 peinado aluminio/laca dorada

€ 150

R12447 negro/blanco

€ 150

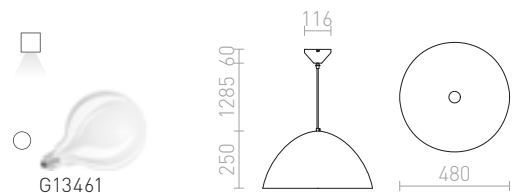



MEZZO

Lámpara de techo con fuente de luz LED incorporada y estructura de aluminio laqueado. Luminaria se suministra con un difusor de luz de policarbonato esmerilado. Con el juego de suspensión, la lámpara se puede instalar como colgante. TRIAC regulable.

MEZZO 80 DIMM DE TECHO

230 V LED 100 W 3000 K 6400 lm Ra 80

R13334 blanco

€ 850

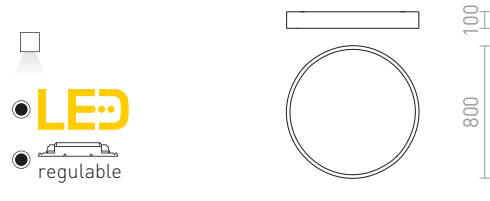

MEZZO

Conjunto adecuado para colgar luminarias de la serie MEZZO.

MEZZO 80 SET COLGANTES

230 V

R13335 blanco

€ 120

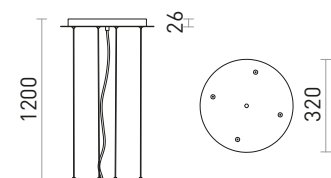



MEZZO

Lámpara de techo con fuente de luz LED incorporada y estructura de aluminio laqueado. Luminaria se suministra con un difusor de luz de policarbonato esmerilado. Con el juego de suspensión, la lámpara se puede instalar como colgante. TRIAC regulable.

MEZZO 40 DIMM DE TECHO

230 V LED 30 W 3000 K 1800 lm Ra 80

R13328 blanco

€ 258

R13329 negro

€ 258

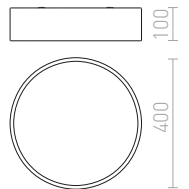
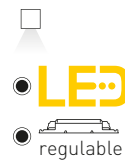

MEZZO 60 DIMM DE TECHO

230 V LED 60 W 3000 K 3700 lm Ra 80

R13332 blanco

€ 480

R13333 negro

€ 480

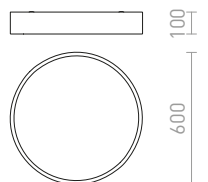
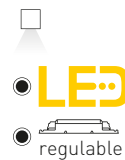

MEZZO

Conjunto adecuado para colgar luminarias de la serie MEZZO.

MEZZO 40/60 SET COLGANTES

230 V

R13330 blanco

€ 58

R13331 negro

€ 58

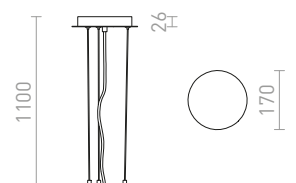



ASTERI

Luminaria colgante con pantalla de cristal satinado. La cubierta inferior se fija con una placa circular de cromo.

ASTERI COLGANTE

230 V 2GX13 40 W

R10626 vidrio satinado/cromo

€ 88 %

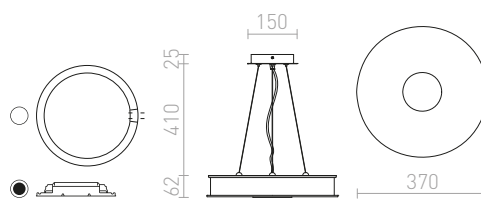

CASSABLANCA

Luminaria para dos fuentes de luz fluorescentes circulares T5. La parte inferior está cubierta con vidrio satinado, fijado con un tornillo cromado. Los paneles laterales de la luminaria están hechos de laca acrílica.

CASSABLANCA 40 COLGANTE

230 V 2GX13 + 2GX13 22 W + 40 W

R10522 cromo

€ 120 %

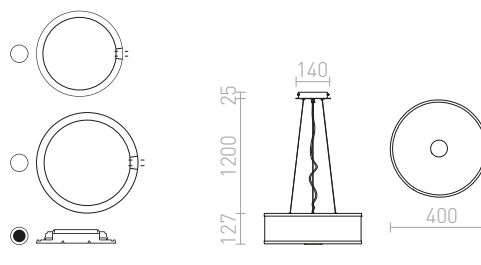

LARISA

Lámpara de techo colgante circular LED con marco minimalista.

LARISA R 30 COLGANTE

230 V LED 30 W 3000 K 2400 lm Ra 80

R12846 blanco

€ 98 %

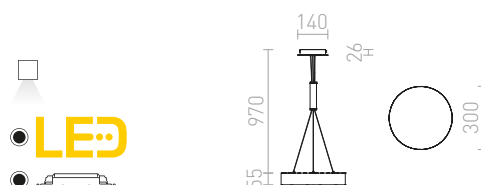



MONETA

Elegante lámpara colgante LED de metal. La luminaria viene con un difusor de policarbonato esmerilado. Atenuación TRIAC.

MONETA DIMM COLGANTE

230 V LED 36 W 3000 K 2500 lm Ra 80

R10581 blanco

€ 290

%

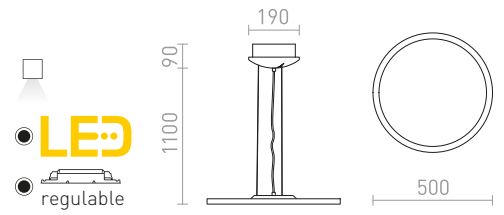



MESA

Lámpara colgante LED con marco de aluminio lacado o cepillado blanco. El accesorio se entrega con un difusor acrílico esmerilado.

MESA SQ 48 COLGANTE

230 V LED 56 W 3000 K 3530 lm Ra 80

R11291 blanco

€ 178 %

R11292 aluminio cepillado

€ 178 %

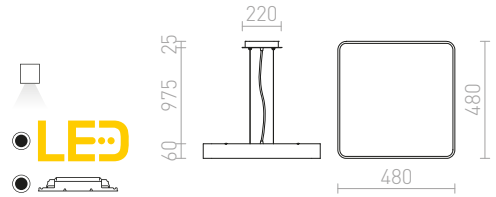



MENSА

Luminaria de LED con marco de aluminio lacado blanco. Entregado con un difusor de acrílico esmerilado.

MENSА RC COLGANTE

230 V LED 36 W 3000 K 2300 lm Ra 80

R10584 blanco

€ 150 %

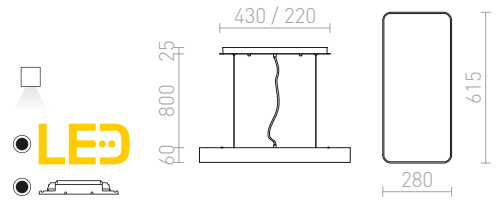

LARISA

Lámpara de techo LED cuadrada con marco minimalista.

LARISA SQ 30 COLGANTE

230 V LED 30 W 3000 K 2400 lm Ra 80

R12852 blanco

€ 88 %

R12853 negro

€ 88 %

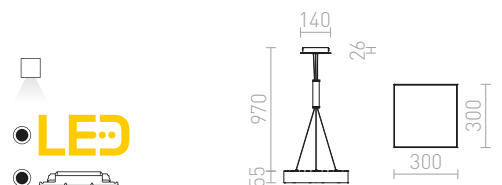





STRUCTURAL

Luminaria LED colgante fabricada en perfil de aluminio, elegante diseño en aluminio natural o laqueado en blanco con difusor de PMMA opalino con iluminación descendente, cable transparente de tres hilos.

STRUCTURAL LED 20x20 COLGANTE

230 V LED 12 W 3000 K 900 lm Ra 80

R13709 aluminio cepillado

€ 158 ➔

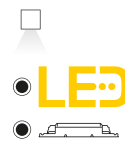
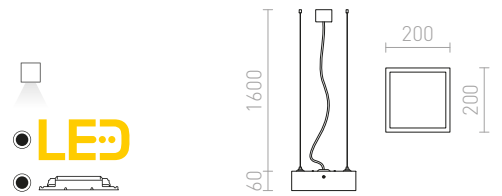

STRUCTURAL LED 40x40 COLGANTE

230 V LED 36 W 3000 K 2600 lm Ra 80

R13710 blanco

€ 290 ➔

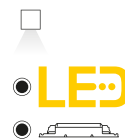
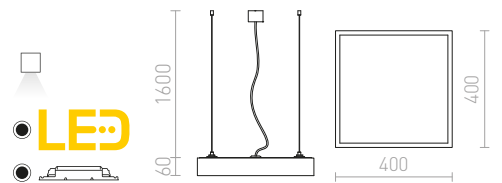

STRUCTURAL LED 55x55 COLGANTE

230 V LED 48 W 3000 K 3600 lm Ra 80

R13713 blanco

€ 178 %

R13714 aluminio cepillado

€ 258 %

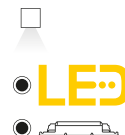
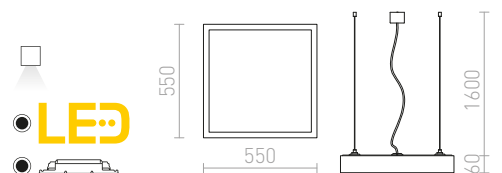





PESANTE

Luminaria de LED lineal colgante adecuada para interiores modernos.

PESANTE 35 COLGANTE

230 V LED 40 W 3000 K 3340 lm Ra 80

R12718 aluminio anodizado

€ 220

R12719 negro

€ 229

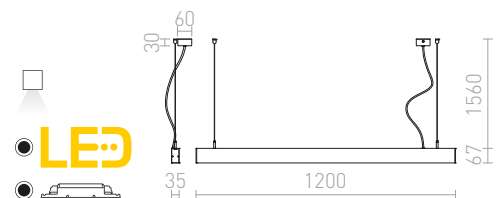

PESANTE 75 COLGANTE

230 V LED 40 W 3000 K 4200 lm Ra 80

R12720 aluminio anodizado

€ 290

R12721 negro

€ 320

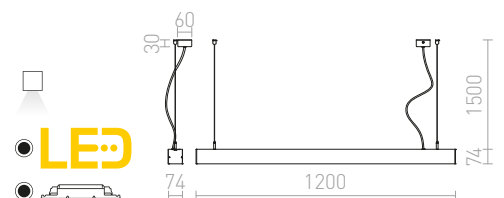



IP65

TRIDENT PRO

Luminaria industrial LED lineal para montaje en techo o suspensión mediante el kit G13672. Alto rendimiento y protección IP65. Se suministra sin kit de suspensión y cable de alimentación. Posibilidad de conectar luminarias en serie.

TRIDENT PRO 120 CUERPO

230 V LED 40 W 4000 K 5200 lm Ra 80 IP65

G13670 gris/acrílico mate

€ 58

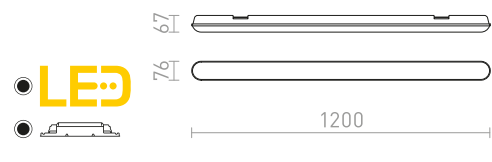

TRIDENT PRO 150 CUERPO

230 V LED 60 W 4000 K 7800 lm Ra 80 IP65

G13671 gris/acrílico mate

€ 88

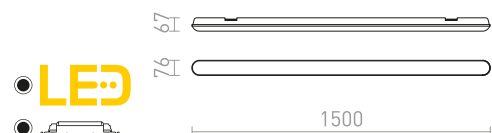



TRIDENT PRO

Set para colgar luminarias Trident.

TRIDENT PRO CONJUNTO COLGANTE 2 PIEZAS

G13672 negro

€ 3.50

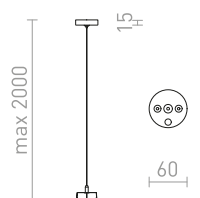

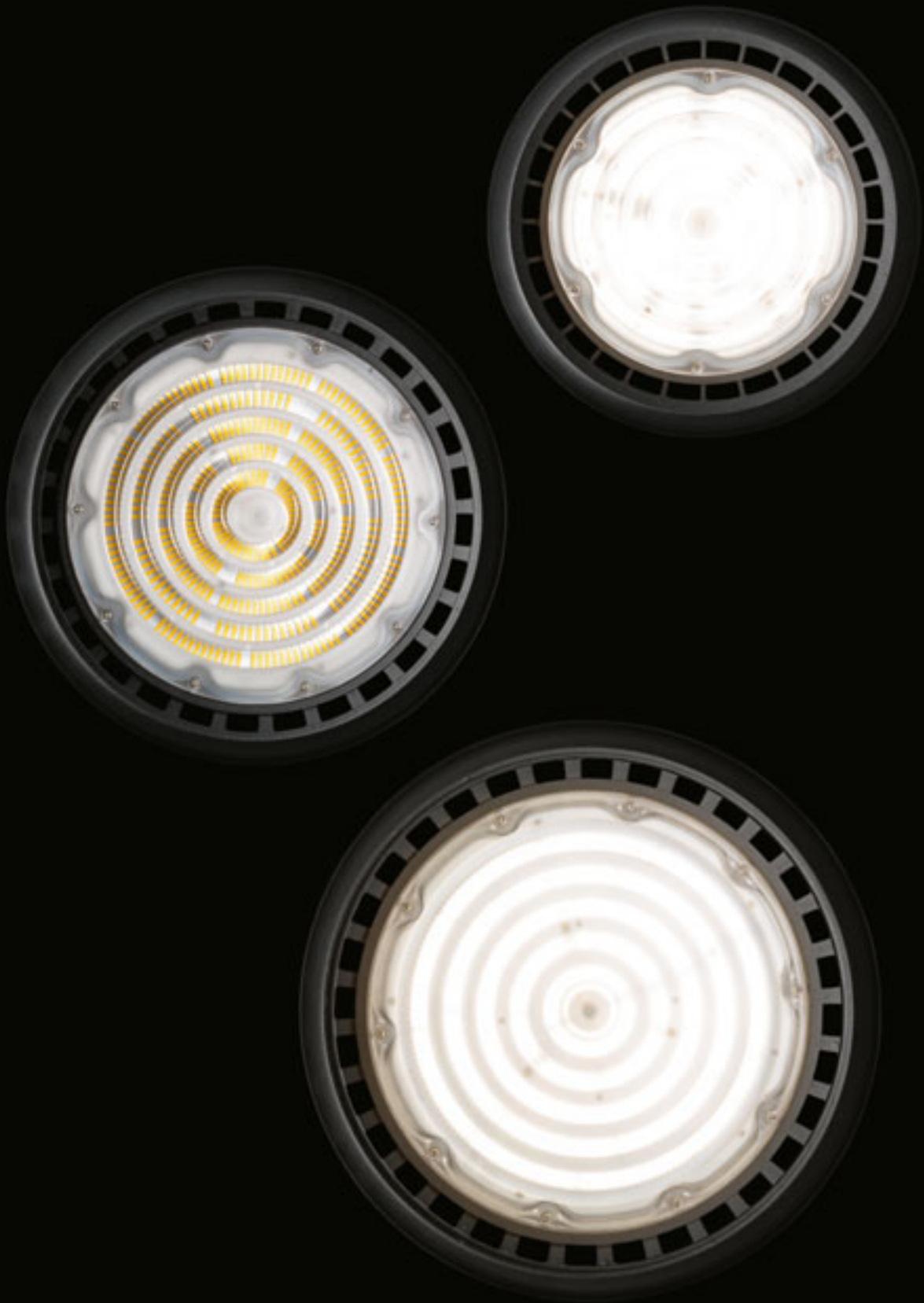



IP65

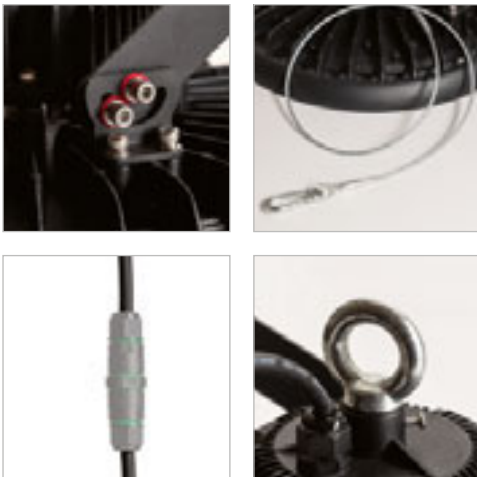

MEGALOS PRO

Reflector LED industrial para suspensión de alta potencia. Se suministra con cable de fijación (0,5 m), argolla de suspensión y cable de alimentación de 0,2 m de longitud. Recomendamos utilizar IP BOX G12984 para conectarlo a su cable de alimentación.

MEGALOS PRO 26 CUERPO

230 V LED 100 W $\angle 90^\circ$ 4000 K 16000 lm Ra 80 IP65

G13749 negro

€ 88

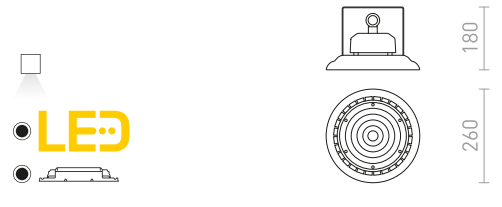

MEGALOS PRO 30 CUERPO

230 V LED 150 W $\angle 90^\circ$ 4000 K 24000 lm Ra 80 IP65

G13750 negro

€ 120

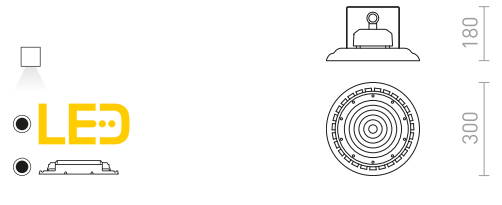

MEGALOS PRO 35 CUERPO

230 V LED 200 W $\angle 90^\circ$ 4000 K 32000 lm Ra 80 IP65

G13751 negro

€ 138





LÁMPARAS DE TECHO

DE BAÑO	96-115
DE YESO	116-121
DECORATIVAS	122-125
LUZ HACIA ABAJO	126-143
CIRCULAR	144-155
RECTANGULAR	156-167
TÉCNICAS	168-173
LONGITUDINALES	174-175

TECHO DE BAÑO



GRANDE LED 25
96-97



GRANDE LED 35
96-97



CIRA LED 23
98-99

96-115



CIRA LED 35
98-99



GORRA
100-101



BARRY
100-101



AWE 23
100-101



AWE 33
100-101



ZARA LED 26
102-103



SARA LED 26
102-103



SARA LED 36
102-103



SASSARI
102-103



VENICE 23
104-105



VENICE LED 30
104-105



ARANA R 17
104-105



ARANA R 27
104-105



BOLLY 17
106-107



BOLLY 26
106-107



MERINGUE 11
106-107



MERINGUE 16
106-107



ESICA CYL
108-109



EIGHT
108-109



ESICA SQ
108-109



LOLA 88
110-111



SAMMY
110-111



EILEEN
110-111



KIM
110-111



ORIN R
112-113



MERIDO
112-113



DEZA
112-113



ORIN SQ
112-113



MERANO LED 30
114-115



MERANO LED 35
114-115



SPECTACLE
114-115



BONO
114-115

TECHO DE YESO

116-121



GINA S 17
116-117



GINA
116-117



GINA III
116-117



COLIN
116-117



JACK SQ
118-119



JACK SQ S 17
118-119



JACK III
118-119



COLES
120-121



COLES SQ
120-121



VOLCA
120-121

TECHO DECORATIVAS

122-125



TACO
122-123



OTIS 60
122-123



SOLARIS
122-123



VENICE 23
124-125



VENICE LED 30
124-125



MARA
124-125

TECHO LUZ HACIA ABAJO

126-143



BOGARD TWIN
126-127



BELENOS
126-127



BOGARD
126-127



CONDU
126-127



SNAZZY
128-129



PIXIE
128-129



DARIO
128-129



DARIO
128-129



PIXIE
128-129



RIGA 38
130-131



RIGA 18
130-131



CONNOR
130-131



KELLY LED
130-131



VADE R
132-133



TUBA
132-133



CANTO
132-133



MOMA
134-135



MOMA
134-135



MOCCA
134-135



MAYO R
134-135



MEA
134-135



MANTOVA I
136-137



MANTOVA II
136-137



GAYA
136-137



MILANO I
136-137



MILANO II
136-137



ENKI EDG I
138-139



ENKI EDG II
138-139



AGATE I
138-139



AGATE II
138-139



BERIT I
140-141



BERIT II
140-141



MAYO SQ
140-141



JAMES I
140-141



JAMES II
140-141



MARVEL
142-143



MARVEL II
142-143



MARVEL II
142-143

TECHO CIRCULAR

144-155



MEZZO 40
144-145



MEZZO 60
144-145



MEZZO 80
144-145



LARISA R 12
146-147



LARISA R 22
146-147



LARISA R 30
146-147



LARISA R 40
146-147



LARISA R 12
148-149



LARISA R 22
148-149



LARISA R 30
148-149



HUE R 9
150-151



HUE R 17
150-151



HUE R 22
150-151



HUE R 9
152-153



HUE R 17
152-153



HUE R 22
152-153



MENSA R 80
154-155



ALLEGRO II 43
154-155

TECHO RECTANGULAR



LARISA SQ 17
156-157



LARISA SQ 22
156-157



LARISA SQ 30
156-157

156-167



LARISA SQ 40
156-157



LARISA SQ 17
158-159



LARISA SQ 22
158-159



LARISA SQ 30
158-159



MENSA SQ 40
160-161



MENSA SQ 48
160-161



MENSA SQ 80
160-161



STRUCTURAL LED 20x20
162-163



STRUCTURAL LED 40x40
162-163



STRUCTURAL LED 55x55
162-163



HUE SQ 9
164-165



HUE SQ 17
164-165



HUE SQ 22
164-165



HUE SQ 9
166-167



HUE SQ 17
166-167



HUE SQ 22
166-167

TECHO TÉCNICAS

168-173



SOCORRO R 300
168-169



SLENDER R 12
168-169



SLENDER SQ 12
168-169



SLENDER SQ 22
168-169



SEMPRE SQ 63
170-171



SEMPRE R 55
170-171



MELISA 25
170-171



MELISA 52
170-171



SEMPRE SQ 33
172-173



SEMPRE SQ 43
172-173



SEMPRE SQ 53
172-173



SEMPRE SQ 63
172-173

TECHO LONGITUDINALES

174-175



STRUCTURAL LED 60x15
174-175



TRIDENT PRO 120
174-175



TRIDENT PRO 150
174-175



IP44



IP44



GRANDE

Plafón LED para baño con cristal plano opalino y estructura metálica.

GRANDE LED 25 TECHO

230 V LED 12 W 3000 K 900 lm Ra 80 IP44

R13676 vidrio opal/cromo

€ 178

R13677 vidrio opal/negro

€ 158

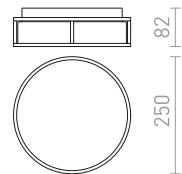

GRANDE LED 35 TECHO

230 V LED 24 W 3000 K 1700 lm Ra 80 IP44

R13678 vidrio opal/cromo

€ 290

R13679 vidrio opal/negro

€ 268

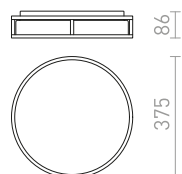





IP44



IP44

CIRA

Luminaria de techo de cristal ovalada con base cromada apta para ambientes húmedos.

CIRA LED 23 TECHO

230 V LED 12 W 3000 K 900 lm Ra 80 IP44

R13680 vidrio opal/negro

€ 120

R13742 vidrio opal/cromo

€ 150

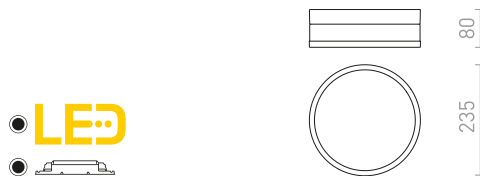

CIRA LED 35 TECHO

230 V LED 24 W 3000 K 1700 lm Ra 80 IP44

R13681 vidrio opal/cromo

€ 258

R13754 vidrio opal/negro

€ 248







IP44

GORRA

Plafón apto para ambientes húmedos. La pantalla está hecha de cristal opalino con dimensiones Ø/V 24/3 cm.

GORRA DE TECHO

230 V E14 2x40 W IP44

R10500 cromo

€ 88 %

R12048 níquel mate

€ 88 %



G11849

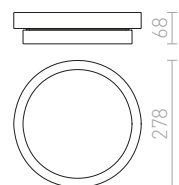



IP44



IP44



IP44



IP44

BARRY

Luminaria circular de baño, con marco de níquel mate para tubos fluorescentes circulares de bajo consumo.

BARRY DE TECHO
230 V 2GX13 22 W IP44

R10576 níquel mate

€ 38

%

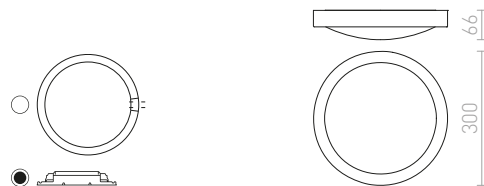
**AWE**

Plafón con LED integrado y pantalla de cristal opal. La base de techo es de cromo o níquel mate. Apto para ambientes húmedos.

AWE 23 DE TECHO
230 V LED 14 W 3000 K 580 lm Ra 80 IP44

R12196 níquel mate

€ 129

R12201 cromo

€ 129

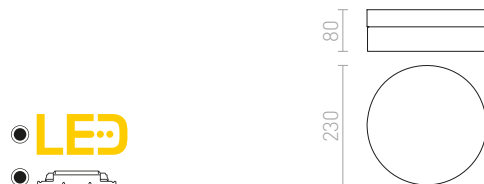

AWE 33 DE TECHO
230 V LED 21 W 3000 K 948 lm Ra 80 IP44

R12197 níquel mate

€ 215

R12202 cromo

€ 215

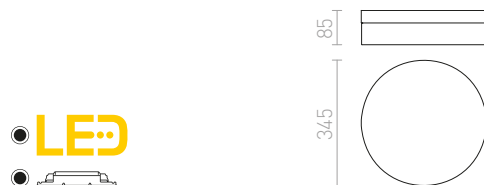



IP44

ZARA

Plafón LED de cristal opalino sobre base cromada, apto para ambientes húmedos.

ZARA LED 26 TECHO

230 V LED 12 W 3000 K 900 lm Ra 80 [IP44](#)

R13686 vidrio opal/cromo

€ 129

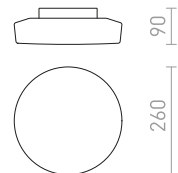

IP65

SASSARI

Plafón LED circular para baño.

SASSARI TECHO

230 V LED 24 W 3000 K 1900 lm Ra 80 IP65

R13642 blanco/polycarbonato/plástico

€ 120

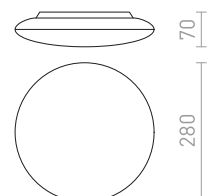



IP44



IP44

SARA

Plafón LED de cristal opalino sobre base cromada ,apto para ambientes húmedos.

SARA LED 26 TECHO

230 V LED 12 W 3000 K 900 lm Ra 80 IP44

R13687 vidrio opal/cromo

€ 129

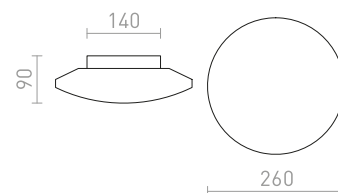

● LED



SARA LED 36 TECHO

230 V LED 24 W 3000 K 1700 lm Ra 80 IP44

R13688 vidrio opal/cromo

€ 229

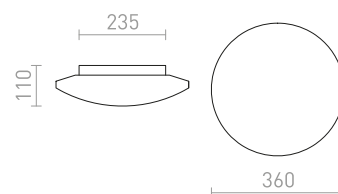

● LED





IP44

ARANA

Cilindro de techo de cristal opalino sobre base cromada, apto para ambientes húmedos.

ARANA R 17 TECHO

230 V E27 15 W IP44

R13682 vidrio opal/cromo

€ 120



G13014



160



170



IP44

ARANA

Cilindro de techo de cristal opalino sobre base cromada, apto para ambientes húmedos.

ARANA R 27 TECHO

230 V E27 20 W IP44

R13683 vidrio opal/cromo

€ 178



G13029

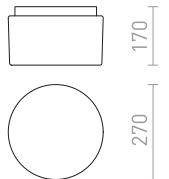

IP44

VENICE

Lámpara de techo en combinación de cristal interior opalino y cristal exterior transparente sobre base cromada para bombillas LED con casquillo E27. Apta para ambientes húmedos.

VENICE 23 TECHO

230 V E27 20 W IP44

R13684 vidrio transparente/vidrio opal/cromo

€ 198



G13307

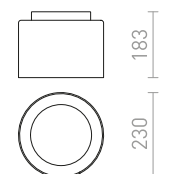

IP44

VENICE

Plafón LED en combinación de cristal interior opalino y cristal exterior transparente sobre base cromada. Apto para ambientes húmedos.

VENICE LED 30 TECHO

230 V LED 12 W 3000 K 900 lm Ra 80 IP44

R13685 vidrio transparente/vidrio opal/cromo

€ 248

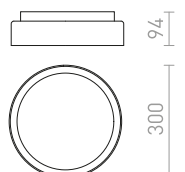





IP44



IP44



IP44

IP44

**BOLLY**

Luminaria de techo de cristal opalino sobre base cromada. Apto para ambientes húmedos.

BOLLY 17 TECHO

230 V E27 15 W IP44

R13693 vidrio opal/cromo

€ 150

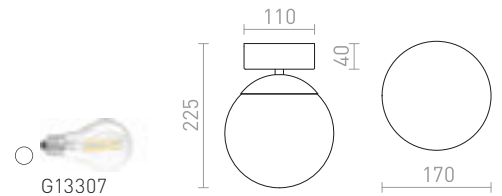
**BOLLY 26 TECHO**

230 V E27 15 W IP44

R13694 vidrio opal/cromo

€ 178

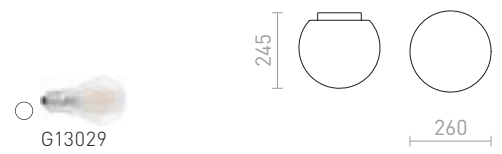
**MERINGUE**

Luminaria de techo de cristal ovalada con base cromada, adecuada para ambientes húmedos.

MERINGUE 11 TECHO

230 V LED G9 9 W IP44

R13689 vidrio opal/cromo

€ 88 %

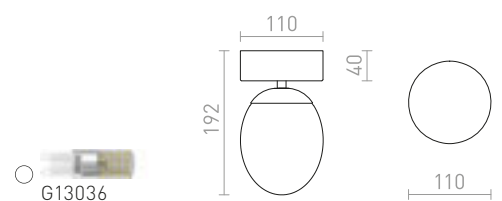
**MERINGUE 16 TECHO**

230 V E27 15 W IP44

R13690 vidrio opal/cromo

€ 120 %

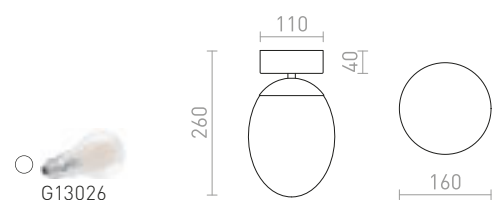



IP44

ESICA

Plafón con LED integrado y cristal de color opalino.
Adecuado para ambientes húmedos.

ESICA SQ DE TECHO

230 V LED 6 W 3000 K 435 lm Ra 80 IP44

R12198 cromo

€ 78

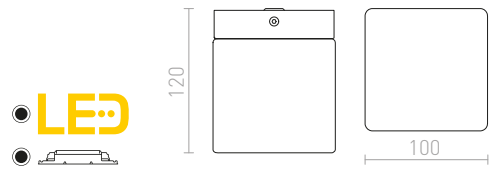

IP44

ESICA

Plafón con LED integrado y cristal de color opalino.
Adecuado para ambientes húmedos.

ESICA CYL DE TECHO

230 V LED 6 W 3000 K 369 lm Ra 80 IP44

R12199 cromo

€ 78

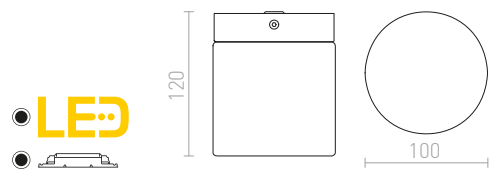

IP44

EIGHT

Lámpara de techo con pantalla de cristal opalino. Apta
para ambientes húmedos.

EIGHT DE TECHO

230 V E27 28 W IP44

R10492 vidrio opal/cromo

€ 98

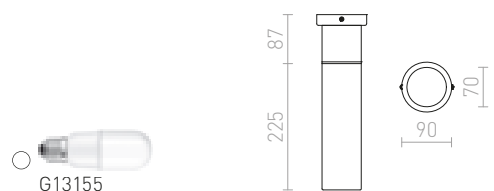





IP65

EILEEN

Cilindro de techo apto para uso en baños para bombilla LED con casquillo GU10.

EILEEN TECHO

230 V GU10 35 W IP65

R13606 blanco

€ 58

R13607 negro

€ 58



G11841

117

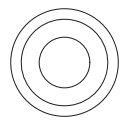
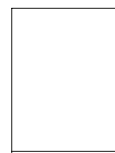

85



IP65

KIM

Prisma de techo apto para uso en baños para bombilla LED con casquillo GU10.

KIM TECHO

230 V GU10 35 W IP65

R13608 blanco

€ 58

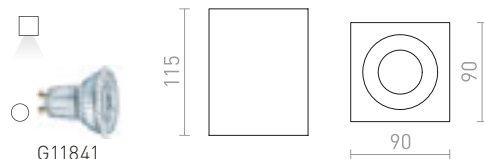

IP54

LOLA

Foco de techo con protección para ambientes húmedos, adecuado para el baño.

LOLA 88 TECHO

230 V GU10 15 W IP54

R13538 blanco

€ 48

R13539 cromo

€ 48

R13542 negro

€ 48

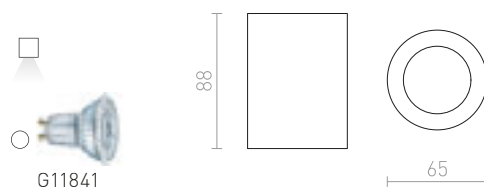

IP54

SAMMY

Plafón para exteriores con casquillo GU10. Tiene una cubierta de vidrio transparente en la parte inferior.

SAMMY EXTERIOR

230 V LED GU10 15 W IP54

R13450 blanco

€ 58

R13451 gris

€ 48

R13452 gris antracita

€ 58

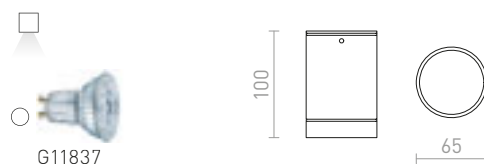



IP54

MERIDO

Plafón para exteriores y fuentes de luz GX53 de bajo consumo.

MERIDO DE TECHO
230 V GX53 11 W IP54

R10428 blanco € 58
R10429 gris plata € 58
R10430 gris antracita € 58

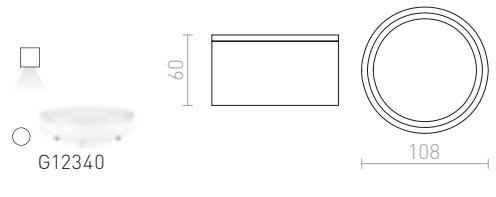

IP54

ORIN

Luminaria de techo LED cilíndrica con pantalla satinada. Apta para exteriores.

ORIN R TECHO
230 V LED 10 W 3000 K 650 lm Ra 80 IP54

R13626 blanco/acrílico satinado € 78
R13627 gris antracita/acrílico satinado € 78

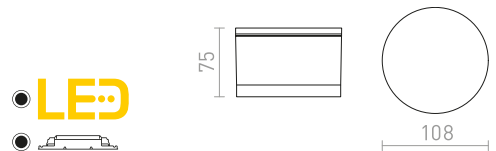



IP54



ORIN

Luminaria de techo LED cuadrada para exterior con pantalla satinada.

ORIN SQ TECHO

230 V LED 10 W 3000 K 800 lm Ra 80 IP54

R13628 blanco/acrílico satinado

€ 78

R13629 gris antracita/acrílico satinado

€ 78

LED

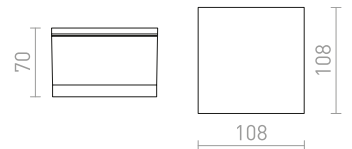

IP54

DEZA

Plafón de aluminio y con una cubierta de vidrio satinado.

DEZA CUADRADO

230 V G9 25 W IP54

R10166 aluminio/vidrio satinado

€ 48



G13036

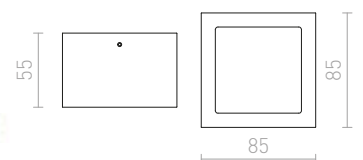

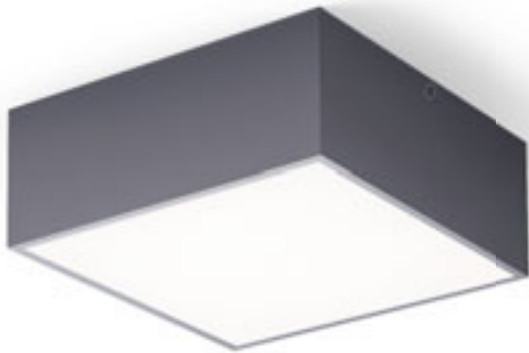

IP65

BONO

Luminaria para exteriores de aluminio fundido a presión, con LED integrado y difusor de color ópalo. Para montaje en techo o pared.

BONO MONTADAS EN SUPERFICIE

230 V LED 4 W 3000 K 297 lm Ra 80 IP65

R11967 gris antracita

€ 150

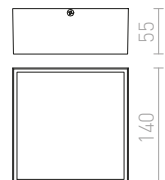
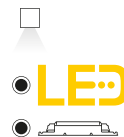



IP54

SPECTACLE

Luminaria para exteriores de aluminio fundido a presión, con LED integrado y difusor de color ópalo. Para montaje en techo o pared.

SPECTACLE MONTADAS EN SUPERFICIE

230 V LED 5 W 3000 K 350 lm Ra 80 IP54

R11968 gris plata

€ 78

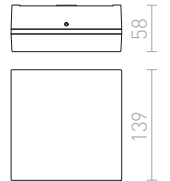
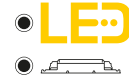

IP44

MERANO

Plafón LED cuadrado apto para ambientes húmedos.

MERANO LED 30 TECHO

230 V LED 16 W 3000 K 1300 lm Ra 80 IP44

R13697 cromo/acrílico mate

€ 178

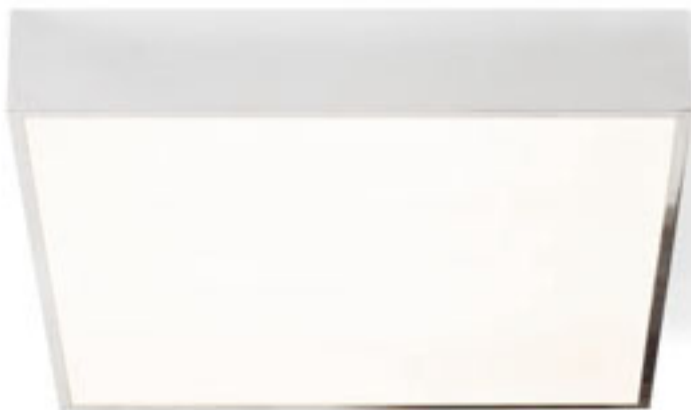
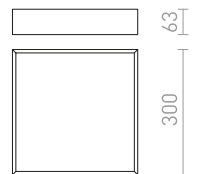

IP44

MERANO LED 35 TECHO

230 V LED 24 W 3000 K 1700 lm Ra 80 IP44

R13698 cromo/acrílico mate

€ 215

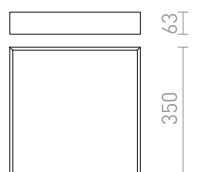



COLIN

Lámpara de techo hecha de yeso con casquillo GU10. La luminaria se puede pintar con pintura para interiores.

COLIN TECHO

230 V LED GU10 5 W

R13791 yeso

€ 58

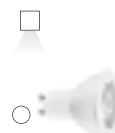

G13466

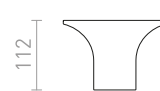

112



68



166



GINA

Plafón de yeso para fuente de luz LED con casquillo GU10. La luminaria se puede pintar con pintura para interiores.

GINA III TECHO

230 V LED GU10 3x5 W

R13789 yeso

€ 120

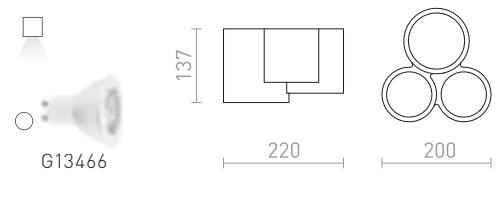

GINA

Lámpara de techo de yeso con casquillo GU10. La luminaria se puede colorear con pintura para interiores.

GINA DE TECHO

230 V LED GU10 15 W

R11680 yeso

€ 78

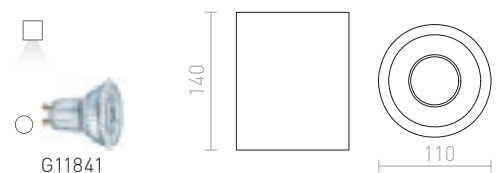

GINA S 17 DE TECHO

230 V GU10 15 W

R12354 yeso

€ 58

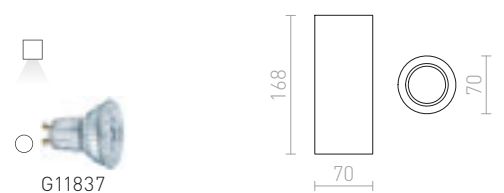





JACK

Plafón hecho de yeso para fuente de luz LED con casquillo GU10. La luminaria se puede pintar con pinturas para interiores.

JACK III TECHO

230 V LED GU10 3x5 W

R13790 yeso

€ 150

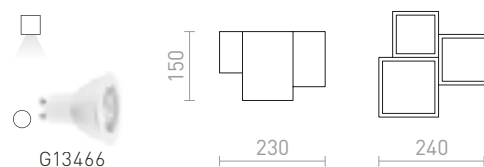

G13466

230

240



JACK

Lámpara de techo angular de yeso para casquillo GU10. La lámpara se puede colorear con pintura para interiores.

JACK SQ DE TECHO

230 V LED GU10 15 W

R11957 yeso

€ 78

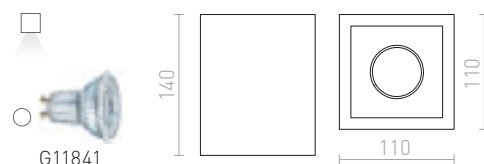

G11841

140

110

110

JACK SQ S 17 DE TECHO

230 V GU10 15 W

R12751 yeso

€ 32 %

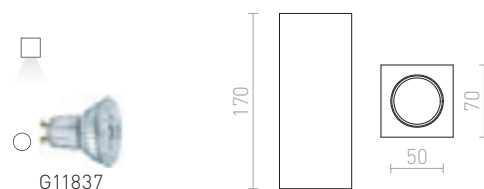

G11837

170

50

70



VOLCA

Lámpara de techo hecha de hormigón para fuentes de luz LED con casquillo GU10.

VOLCA TECHO

230 V LED GU10 5 W

R13795 hormigón/decoración de granito oscuro € 48

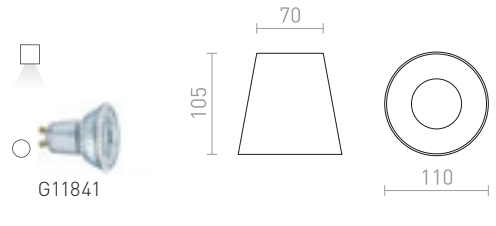

COLES

Lámpara de techo para una fuente de luz que se puede inclinar en un eje. El dispositivo se puede colorear con pintura para interiores.

COLES SQ APLIQUE DE TECHO

230 V LED GU10 15 W

R13438 yeso

€ 58 %

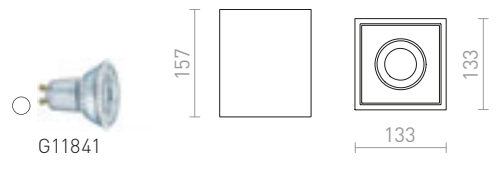

COLES

Lámpara de techo para una fuente de luz que se puede inclinar en un eje. El dispositivo se puede colorear con pintura para interiores.

COLES DE TECHO INCLINABLE

230 V GU10 15 W

R10454 yeso

€ 120

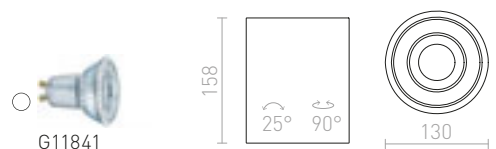





SOLARIS

Lámpara de superficie de cristal con base lacada en negro. Apto para fuentes de luz LED con rosca E14.

SOLARIS PARED O TECHO

230 V LED E14 7 W

R13994 vidrio transparente/negro

€ 78

NEW

R13995 vidrio escarchado/negro

€ 78

NEW

R13996 vidrio de color humo/negro

€ 78

NEW

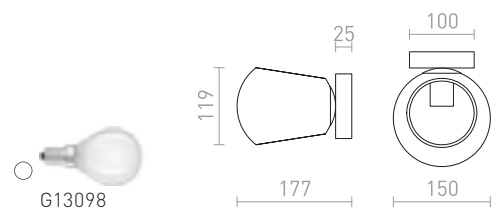



TACO

Plafón cilíndrico con pantalla textil y casquillo E27, adecuado para fuentes de luz de bajo consumo.

TACO DE TECHO

230 V E27 15 W

R12471 negro/cromo

€ 48 %

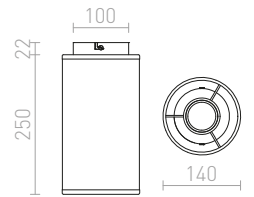

OTIS

Plafón redondo con doble pantalla textil para fuentes de luz con casquillo E27. La pantalla interior es siempre en color blanco.

OTIS 60 DE TECHO

230 V E27 4x28 W

R13807 blanco/blanco

€ 420

R13808 negro transparente/blanco

€ 420

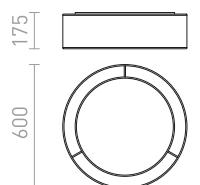



MARA

Plafón con LED integrado, base cromada y difusor ligeramente convexo.

MARA DE TECHO

230 V LED 24 W 3000 K 1760 lm Ra 80

R12894 acrílico esmerilado/cromo

€ 88

%

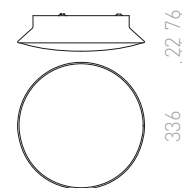

IP44

VENICE

Lámpara de techo en combinación de cristal interior opalino y cristal exterior transparente sobre base cromada para bombillas LED con casquillo E27. Apta para ambientes húmedos.

VENICE 23 TECHO

230 V E27 20 W IP44

R13684 vidrio transparente/vidrio opal/cromo

€ 198



G13307

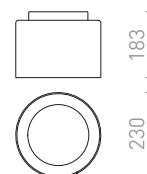

IP44

VENICE

Plafón LED en combinación de cristal interior opalino y cristal exterior transparente sobre base cromada. Apto para ambientes húmedos.

VENICE LED 30 TECHO

230 V LED 12 W 3000 K 900 lm Ra 80 IP44

R13685 vidrio transparente/vidrio opal/cromo

€ 248

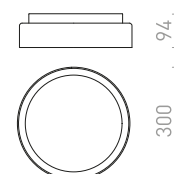





BOGARD

Luminaria de techo con un foco LED fijo y uno ajustable.

BOGARD TWIN DE TECHO

230 V LED 2x5 W $\angle 40^\circ$ 3000 K 700 lm Ra 80

R12499 negro mate

€ 120

R12500 níquel mate

€ 88

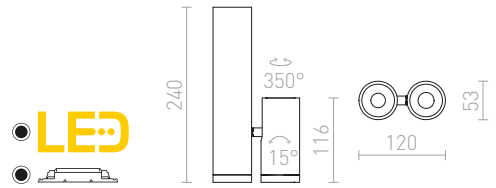

BOGARD

Foco direccional en forma de tubo con LED integrado.

BOGARD DE TECHO

230 V LED 5 W $\angle 40^\circ$ 3000 K 414 lm Ra 80

R12497 negro mate

€ 68

R12498 níquel mate

€ 78

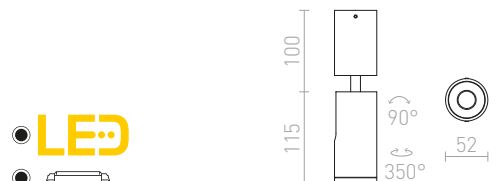

BELENOS

Foco cilíndrico minimalista para fuentes de luz GU10 sobre base redonda. Los resortes del casquillo permiten el uso de fuentes de luz de varias longitudes.

BELENOS APLIQUE DE TECHO

230 V LED GU10 9 W

R13363 blanco

€ 48

R13364 negro

€ 48

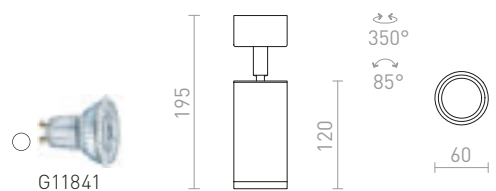



CONDU

Foco de techo LED, cilíndrico, macizo e inclinable.

CONDU DE TECHO

230 V LED 20 W $\angle 24^\circ$ 3000 K 1600 lm Ra 80

R12839 blanco

€ 120

R12840 negro

€ 120

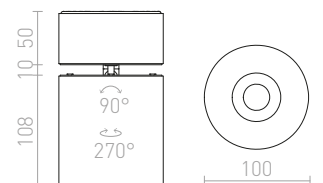

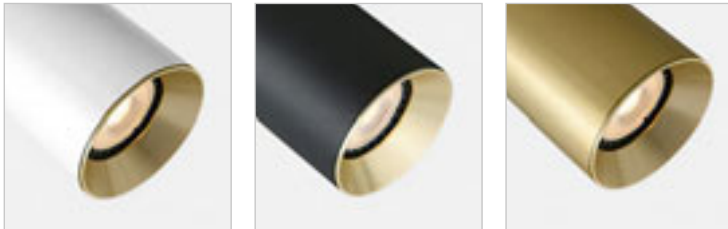

PIXIE

Lámpara de techo, hecha de aluminio para fuentes de luz LED de bajo consumo con casquillo GX53.

PIXIE DE TECHO

230 V LED GX53 7 W

R11770 blanco/cromo

€ 138

R11771 negro/cromo

€ 138

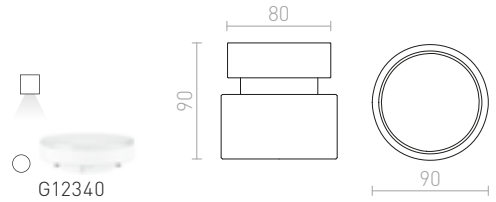

DARIO

Luz de techo cilíndrica orientable con casquillo GU10 para fuentes de luz LED, incluye pantalla decorativa de latón negro cepillado. Hay diferentes combinaciones de colores disponibles comprando pantallas adicionales en otros colores.

DARIO TECHO

230 V GU10 9 W

R13867 blanco/latón cepillado

€ 68

NEW

R13868 negro/latón cepillado

€ 68

NEW

R13869 latón cepillado

€ 78

NEW

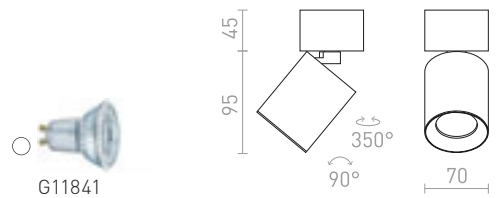

DARIO

Pantalla interior decorativa de metal en varios colores para la lámpara DARIO.

DARIO ANILLO DECORATIVO

R13876 blanco

€ 8.50

NEW

R13877 negro

€ 8.50

NEW

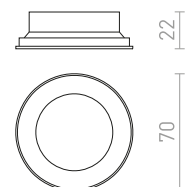



PIXIE

Lámpara direccional sobre base, para fuentes de luz LED de bajo consumo con casquillo GX53.

PIXIE INCLINABLE

230 V LED GX53 7 W

R11772 blanco/cromo

€ 138

R11773 negro/cromo

€ 138

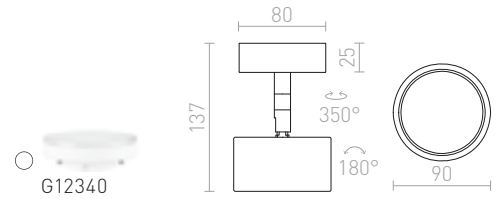

SNAZZY

Foco de techo, cilíndrico e inclinable, para fuentes de luz GU10.

SNAZZY

230 V GU10 35 W

R12670 blanco

€ 78

R13552 negro

€ 78

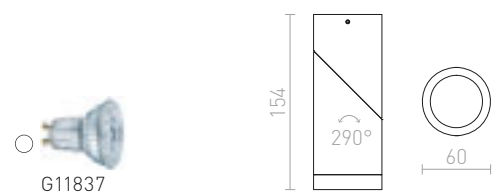



KELLY LED

Lámpara de techo, regulable con fuente de luz LED fija integrada. Atenuación TRIAC.

KELLY LED DIMM DE TECHO

230 V LED 15 W $\angle 45^\circ$ 3000 K 750 lm Ra 85

R12633 blanco

€ 120

R12634 negro

€ 120

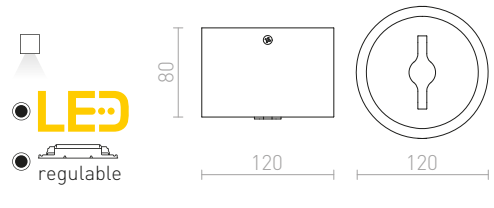

RIGA

Luminaria de techo LED, diseñada en cuatro colores.

RIGA 18 DE TECHO

230 V LED 4 W $\angle 38^\circ$ 3000 K 285 lm Ra 80

R12448 cromo

€ 68

R12449 cobre

€ 68

R12450 blanco

€ 78

R12451 negro

€ 78



RIGA 38 DE TECHO

230 V LED 6 W $\angle 38^\circ$ 3000 K 570 lm Ra 80

R12452 cromo

€ 68

R12453 cobre

€ 68

R12454 blanco

€ 78

R12455 negro

€ 78





CONNOR

Plafón cilíndrico con casquillo fijo GU10.

CONNOR DE TECHO

230 V LED GU10 10 W

R13496 blanco/negro

€ 48

R13501 negro/oro

€ 48



G11841

96

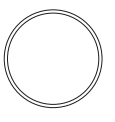
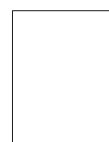

69



CANTO

Foco de techo, diseñado de forma cilíndrica. Adecuado para ser combinado con el adorno decorativo CANTO.

CANTO LUZ DE TECHO SIN PANTALLA INTERIOR
230 V LED GU10 8 W

R13471 blanco

€ 48

R13472 negro

€ 48



G11841

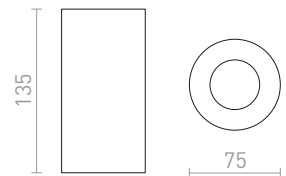

CANTO

Moldura decorativa en cuatro variedades de color para la luz CANTO.

CANTO PANTALLA INTERIOR DECORATIVA

R13473 blanco

€ 6

R13474 oro

€ 6

R13475 hoja de cobre

€ 6

R13476 negro

€ 6

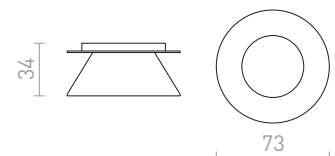



TUBA

Foco de techo, diseñado de forma cilíndrica, para uso de fuentes de luz fijas GU10.

TUBA DE TECHO

230 V GU10 35 W

R12745 blanco mate/oro

€ 48

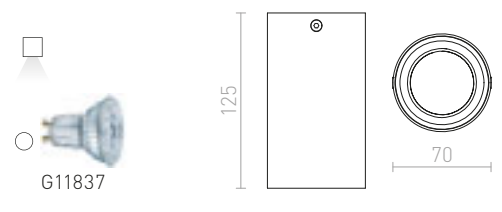

VADE

Foco de techo para fuentes de luz fijas GU10.

VADE R

230 V GU10 35 W

R12669 blanco/negro

€ 48

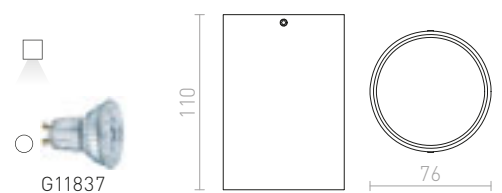



MAYO

Foco direccional, cilíndrico montado en superficie con LED integrado. Driver incluido.

MAYO R DE TECHO DIRECCIONAL

230 V LED 9 W $\angle 36^\circ$ 2700 K 400 lm Ra 80

R10374 aluminio cepillado

€ 78 %

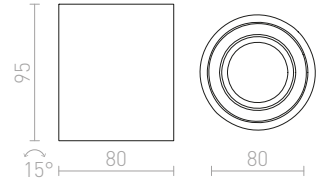

MEA

Luminaria de techo cilíndrica para una fuente de luz E27 de bajo consumo, con vidrio satinado.

MEA DE TECHO CILÍNDRICO

230 V E27 18 W

R10212 aluminio cepillado

€ 58 %

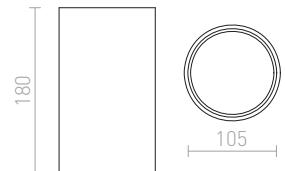

MOCCA

Foco inclinable de forma cilíndrica. Hecho de aluminio pulido.

MOCCA DE TECHO

230 V GU10 50 W

R10124 aluminio

€ 78 →

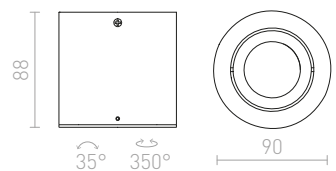



MOMA

Lámpara de techo cilíndrica inclinable para fuentes de luz con casquillo GU10.

MOMA INCLINABLE

230 V GU10 35 W

R12044 blanco

€ 58

R12517 negro

€ 58

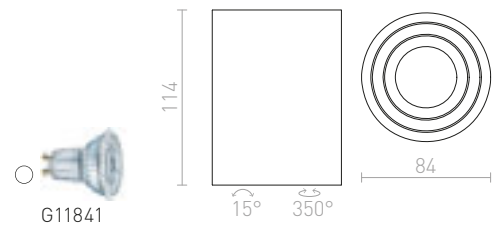

MOMA

Lámpara de techo cilíndrica para una fuente de luz halógena fija. Tiene una altura máxima de 56 mm.

MOMA DE TECHO

230 V GU10 35 W

R12043 blanco

€ 35

R12047 níquel mate

€ 26

R12516 negro

€ 35

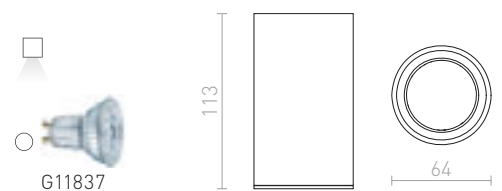



MANTOVA

Luminaria de techo con casquillo fijo GU10.

MANTOVA I DE TECHO

230 V GU10 35 W

R12729 blanco mate € 38

R12730 aluminio cepillado € 38

R12731 negro mate € 38

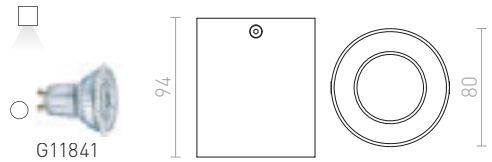

MANTOVA II DE TECHO

230 V GU10 2x35 W

R12732 blanco mate € 68

R12733 aluminio cepillado € 48

R12734 negro mate € 68

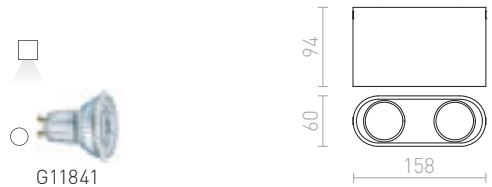

GAYA

Luminaria cilíndrica montada en superficie para una fuente de luz fija con casquillo GU10.

GAYA

230 V GU10 35 W

R12667 blanco € 35

R12668 negro € 35

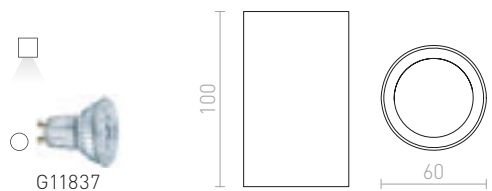



MILANO

Luminaria de techo montada en superficie, inclinable para fuentes de luz GU10.

MILANO I DE TECHO

230 V GU10 35 W

R12681 negro mate/aluminio cepillado

€ 48

R12682 aluminio cepillado

€ 48

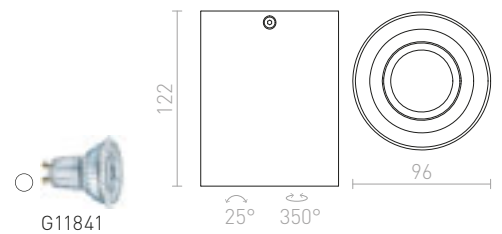

MILANO II DE TECHO

230 V GU10 2x35 W

R12684 aluminio cepillado

€ 68

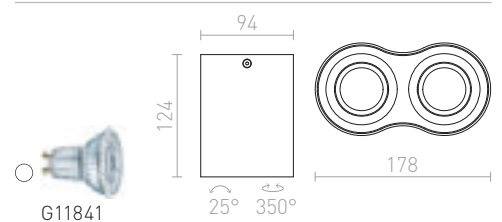





AGATE

Luminaria de techo angular para casquillo fijo GU10.

AGATE I DE TECHO

230 V GU10 35 W

R12735 blanco mate

€ 35

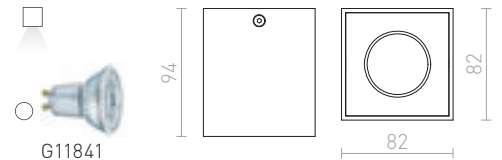

AGATE II DE TECHO

230 V GU10 2x35 W

R12737 blanco mate

€ 58

R12738 aluminio cepillado

€ 35

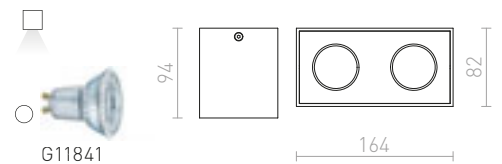

ENKI

Plafón angular montado en superficie inclinable para bombillas con casquillo GU10.

ENKI EDG I

230 V GU10 35 W

R12672 blanco

€ 58

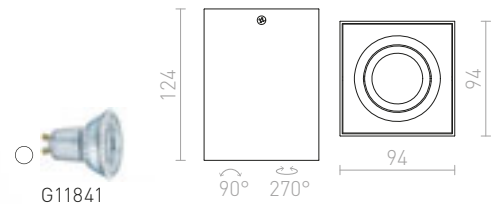

ENKI EDG II

230 V GU10 2x35 W

R12673 blanco

€ 98

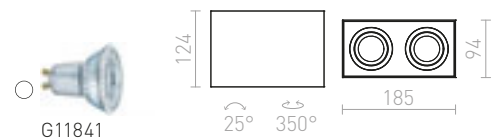



BERIT

Luminaria de techo, rectangular, hecha de aluminio para fuentes de luz GU10 que pueden ser inclinables en dos ejes.

BERIT I DE TECHO

230 V GU10 50 W

R10119 aluminio

€ 58 %

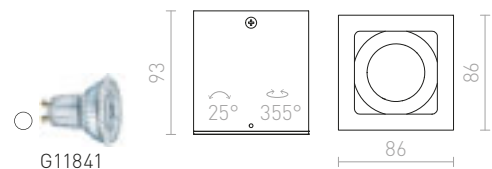

BERIT II DE TECHO

230 V GU10 2x50 W

R10120 aluminio

€ 68 %





JAMES

Lámpara de techo lacada con LED incorporado que es inclinable en dos ejes. TRIAC regulable.

JAMES I DIMM DE TECHO

230 V LED 15 W $\angle 24^\circ$ 3000 K 800 lm Ra 80

R13361 blanco mate

€ 88 %

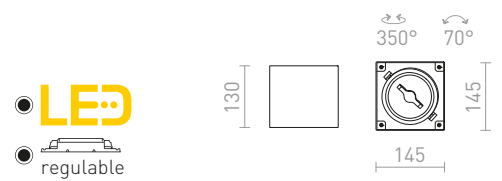

JAMES II DIMM DE TECHO

230 V LED 2x15 W $\angle 24^\circ$ 3000 K 1600 lm Ra 80

R13362 blanco mate

€ 158 %

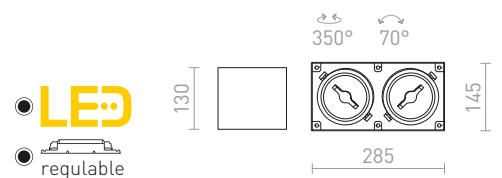

MAYO

Foco cúbico montado en superficie con LED integrado. Driver incluido.

MAYO SQ DE TECHO DIRECCIONAL

230 V/700 mA LED 9 W $\angle 36^\circ$ 2700 K 400 lm Ra 80

R10326 blanco

€ 120 %

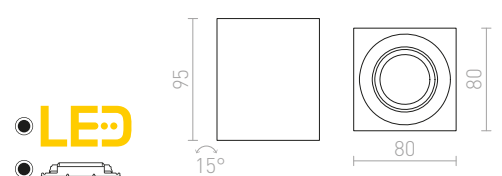





MARVEL

Luminaria cuadrada de aluminio para bombillas dicroicas, con dos brazos basculantes independientes sobre una base.

MARVEL II INCLINABLE

230 V GU10 2x50 W

R10171 aluminio

€ 48 %

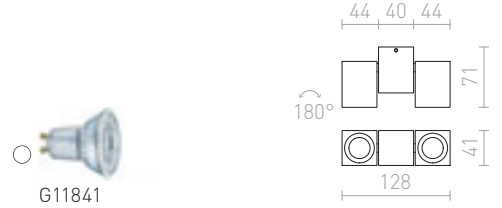

MARVEL

Luminaria angular de aluminio para fuentes de luz GU10 que no son inclinables.

MARVEL DE TECHO

230 V GU10 50 W

R10122 aluminio

€ 14.50 %

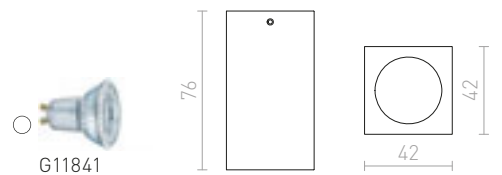

MARVEL II DE TECHO

230 V GU10 2x50 W

R10123 aluminio

€ 15.50 %

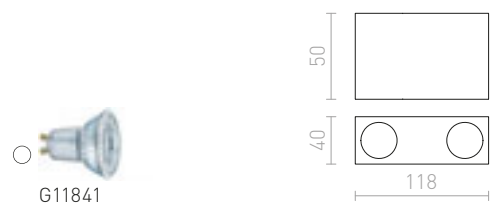



MEZZO

Lámpara de techo con fuente de luz LED incorporada y estructura de aluminio laqueado. Luminaria se suministra con un difusor de luz de policarbonato esmerilado. Con el juego de suspensión, la lámpara se puede instalar como colgante. TRIAC regulable.

MEZZO 40 DIMM DE TECHO

230 V LED 30 W 3000 K 1800 lm Ra 80

R13328 blanco

€ 258

R13329 negro

€ 258

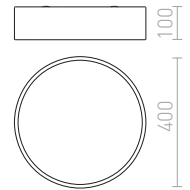
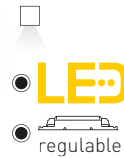

MEZZO 60 DIMM DE TECHO

230 V LED 60 W 3000 K 3700 lm Ra 80

R13332 blanco

€ 480

R13333 negro

€ 480

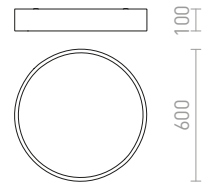
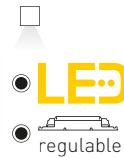

MEZZO 80 DIMM DE TECHO

230 V LED 100 W 3000 K 6400 lm Ra 80

R13334 blanco

€ 850

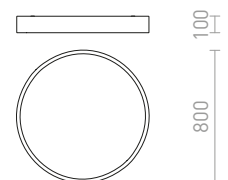
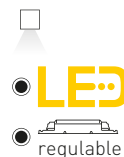







LARISA

Plafón de techo con LED y marco minimalista.

LARISA R 12 DE TECHO

230 V LED 10 W 3000 K 800 lm Ra 80

R12842 blanco

€ 58

R12843 oro perlado

€ 58

R13479 negro

€ 58

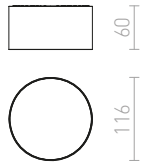

LARISA R 22 DE TECHO

230 V LED 20 W 3000 K 1600 lm Ra 80

R13481 blanco

€ 98

R13482 oro perlado

€ 98

R13483 negro

€ 98

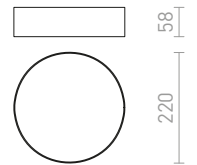
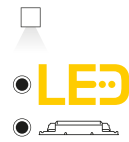

LARISA R 30 DE TECHO

230 V LED 30 W 3000 K 2400 lm Ra 80

R12844 blanco

€ 138

R12845 oro perlado

€ 150

R13480 negro

€ 138

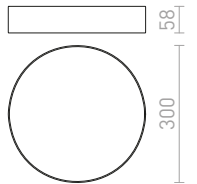
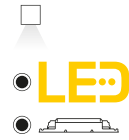

LARISA R 40 DE TECHO

230 V LED 50 W 3000 K 4000 lm Ra 80

R13484 blanco

€ 215

R13485 oro perlado

€ 215

R13486 negro

€ 215

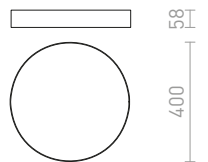
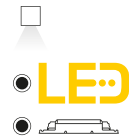



LARISA

Plafón de techo con LED y marco minimalista. TRIAC regulable.

LARISA R 12 DIMM DE TECHO

230 V LED 10 W 3000 K 800 lm Ra 80

R13157 blanco € 88

R13164 oro perlado € 88

R13551 negro € 88



LED

regulable

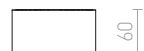

LARISA R 22 DIMMABLE TECHO

230 V LED 20 W 3000 K 1600 lm Ra 80

R13743 oro perlado € 138

R13843 negro € 129

R13844 blanco € 129



LED

regulable

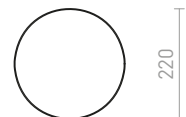
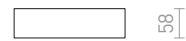

LARISA R 30 DIMM DE TECHO

230 V LED 30 W 3000 K 2400 lm Ra 80

R13177 blanco € 178

R13178 oro perlado € 178

R13570 negro € 178



LED

regulable

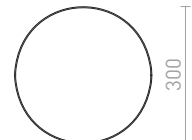
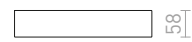







HUE

Luminaria montada en superficie muy delgada con LED integrado de alto rendimiento. El marco está disponible en cromo, cromo negro, níquel mate, lacado blanco e imitación de madera.

HUE R 9 DE TECHO

230 V LED 6 W 3000 K 540 lm Ra 80

R12790 blanco	€ 26	➔
R12791 cromo negro	€ 19.50	%
R12792 cromo	€ 24	%
R12794 decoración de haya	€ 28	➔

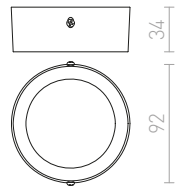

HUE R 17 DE TECHO

230 V LED 18 W 3000 K 1620 lm Ra 80

R12795 blanco	€ 58	➔
R12798 níquel mate	€ 48	%
R12799 decoración de haya	€ 48	%
R13404 imitación de nogal oscuro	€ 48	%

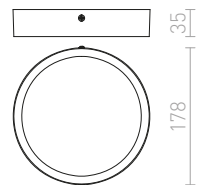

HUE R 22 DE TECHO

230 V LED 24 W 3000 K 2160 lm Ra 80

R12800 blanco	€ 68	➔
R12804 decoración de haya	€ 68	%
R13405 imitación de nogal oscuro	€ 68	%

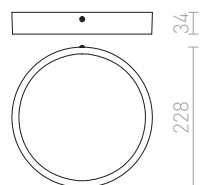



HUE

Luminaria montada en la superficie muy delgada con LED regulable de alto rendimiento. Los marcos están disponibles en cromo, cromo negro, níquel mate, lacado blanco o imitación madera. Regulable TRIAC.

HUE R 9 DIMM DE TECHO

230 V LED 6 W 3000 K 540 lm Ra 80

R13137 blanco	€ 58	→
R13138 cromo negro	€ 58	→
R13139 cromo	€ 58	→
R13141 decoración de haya	€ 58	→

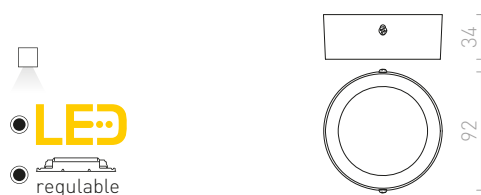

HUE R 17 DIMM DE TECHO

230 V LED 18 W 3000 K 1620 lm Ra 80

R13073 blanco	€ 120	→
R13076 níquel mate	€ 120	→
R13077 decoración de haya	€ 120	→
R13444 imitación de nogal oscuro	€ 120	→

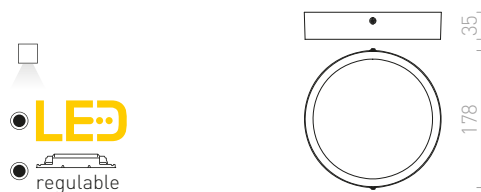

HUE R 22 DIMM DE TECHO

230 V LED 24 W 3000 K 2160 lm Ra 80

R13078 blanco	€ 129	→
R13082 decoración de haya	€ 138	→
R13445 imitación de nogal oscuro	€ 129	→









MENSA

Plafón con LED integrado y marco de aluminio. Viene con un difusor de acrílico esmerilado.

MENSA R 80 DE TECHO

230 V LED 80 W 3000 K 6800 lm Ra 80

R12119 aluminio cepillado

€ 560 %

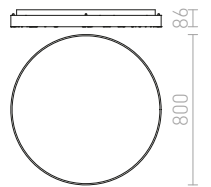
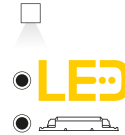

ALLEGRO

Lámpara de techo con fuente de luz LED incorporada y marco de aluminio lacado. El difusor de plástico empotrado está incluido. Atenuación TRIAC.

ALLEGRO II 43 DIMM TECHO

230 V LED 30 W 3000 K 1950 lm Ra 80

R13730 blanco

€ 360

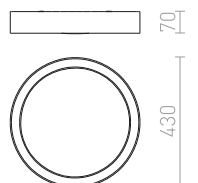
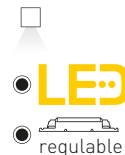

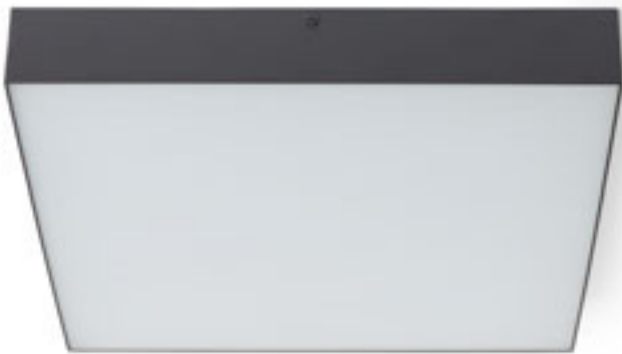

LARISA

Plafón de techo con LED y marco minimalista.

LARISA SQ 17 DE TECHO

230 V LED 15 W 3000 K 1200 lm Ra 80

R12848 blanco

€ 78

R12849 negro

€ 78

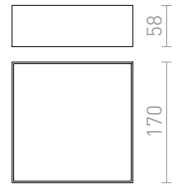

LARISA SQ 22 DE TECHO

230 V LED 20 W 3000 K 1600 lm Ra 80

R13487 blanco

€ 88

R13488 negro

€ 88

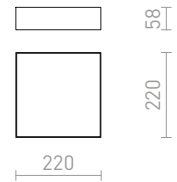
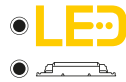

LARISA SQ 30 DE TECHO

230 V LED 30 W 3000 K 2400 lm Ra 80

R12850 blanco

€ 138

R12851 negro

€ 138

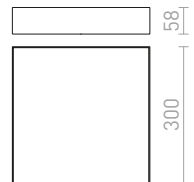

LARISA SQ 40 DE TECHO

230 V LED 50 W 3000 K 4000 lm Ra 80

R13489 blanco

€ 188

R13490 negro

€ 188

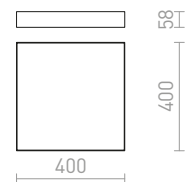







LARISA

Plafón de techo con LED y marco minimalista. TRIAC regulable.

LARISA SQ 17 DIMM DE TECHO

230 V LED 15 W 3000 K 1200 lm Ra 80

R13158 blanco

€ 98

R13938 negro

€ 98

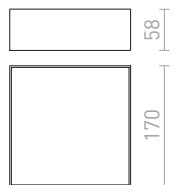

LARISA SQ 22 DIMM TECHO

230 V LED 20 W 3000 K 1600 lm Ra 80

R13851 blanco

€ 120

R13939 negro

€ 120

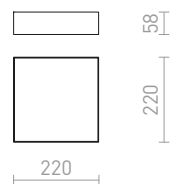
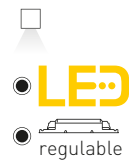

LARISA SQ 30 DIMM DE TECHO

230 V LED 30 W 3000 K 2400 lm Ra 80

R13267 blanco

€ 178

R13268 negro

€ 178

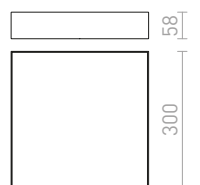
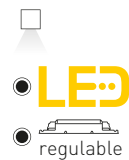

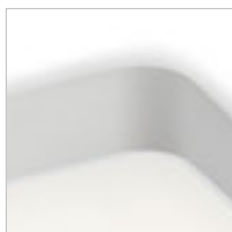
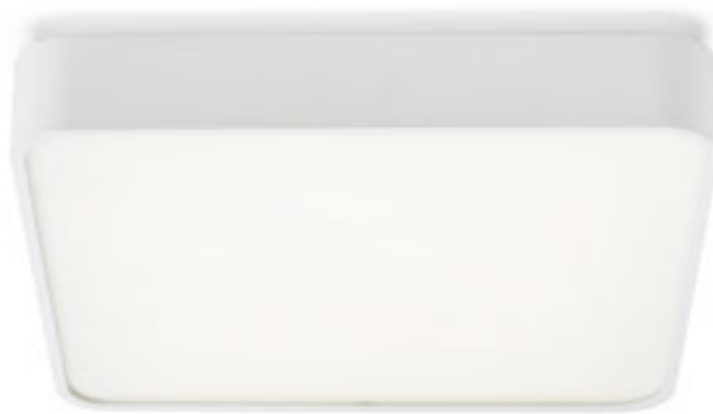

MENSA

Plafón con LED integrado y marco de aluminio lacado o cepillado. Viene con un difusor de acrílico esmerilado.

MENSA SQ 40 DE TECHO

230 V LED 38 W 3000 K 2470 lm Ra 80

R10582 blanco

€ 198 %

R11290 aluminio cepillado

€ 220 %

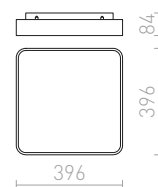
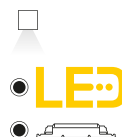

MENSA SQ 48 DE TECHO

230 V LED 56 W 3000 K 3640 lm Ra 80

R11299 aluminio cepillado

€ 178 %

R12120 blanco

€ 268 →

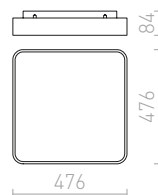
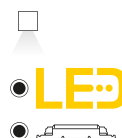

MENSA SQ 80 DE TECHO

230 V LED 138 W 3000 K 8700 lm Ra 80

R12121 aluminio cepillado

€ 580 %

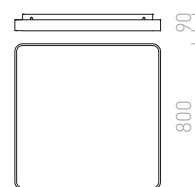
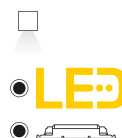





STRUCTURAL

Luminaria de superficie con LED integrado y marco de aluminio lacado. Driver incluido.

STRUCTURAL LED 40x40 MONTADAS EN SUPERFICIE

230 V LED 40 W 3000 K 2918 lm Ra 80

R12063 blanco

€ 215

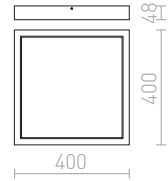

STRUCTURAL

Plafón LED fabricado en perfil de aluminio, elegante diseño en aluminio natural o lacado en blanco con difusor de PMMA opalino con iluminación descendente.

STRUCTURAL LED 20x20 MONTADAS EN SUPERFICIE

230 V LED 12 W 3000 K 900 lm Ra 80

R13707 blanco

€ 150 →

R13708 aluminio cepillado

€ 150 →

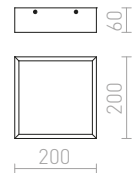
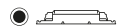

STRUCTURAL LED 55x55 MONTADAS EN SUPERFICIE

230 V LED 48 W 3000 K 3600 lm Ra 80

R13711 blanco

€ 229 %

R13712 aluminio cepillado

€ 229 %

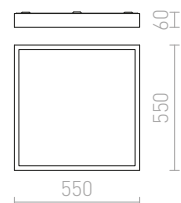





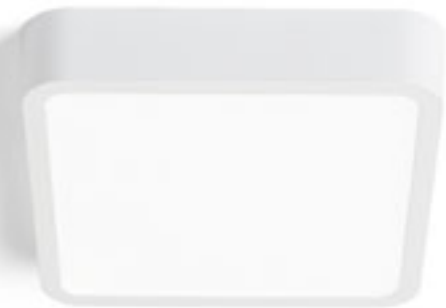

HUE

Luminaria montada en superficie muy delgada con LED integrado de alto rendimiento. El marco está disponible en cromo, cromo negro, níquel mate, lacado blanco e imitación de madera.

HUE SQ 9 DE TECHO

230 V LED 6 W 3000 K 540 lm Ra 80

R12805 blanco	€ 24	➔
R12806 cromo negro	€ 18	%
R12807 cromo	€ 17	%
R12808 níquel mate	€ 15	%

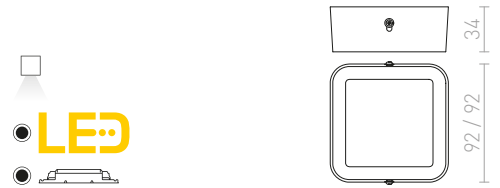

HUE SQ 17 DE TECHO

230 V LED 18 W 3000 K 1620 lm Ra 80

R12810 blanco	€ 58	➔
R12811 cromo negro	€ 32	%
R12812 cromo	€ 35	%
R12813 níquel mate	€ 32	%
R12814 decoración de haya	€ 58	➔

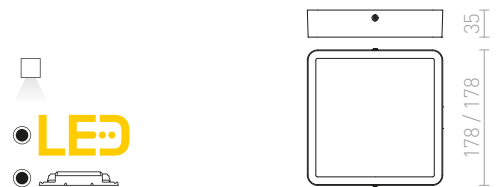

HUE SQ 22 DE TECHO

230 V LED 24 W 3000 K 2160 lm Ra 80

R12815 blanco	€ 78	➔
R12816 cromo negro	€ 48	%
R12817 cromo	€ 48	%
R12818 níquel mate	€ 35	%

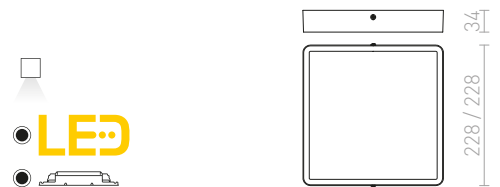



HUE

Luminaria montada en la superficie muy delgada con LED regulable de alto rendimiento. Los marcos están disponibles en cromo, cromo negro, níquel mate, lacado blanco o imitación madera. Atenuación TRIAC.

HUE SQ 9 DIMM DE TECHO

230 V LED 6 W 3000 K 540 lm Ra 80

R13142 blanco	€ 58	➔
R13143 cromo negro	€ 58	➔
R13144 cromo	€ 58	➔
R13145 níquel mate	€ 58	➔

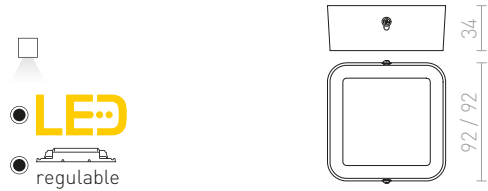

HUE SQ 17 DIMM DE TECHO

230 V LED 18 W 3000 K 1620 lm Ra 80

R13083 blanco	€ 120	➔
R13084 cromo negro	€ 120	➔
R13085 cromo	€ 120	➔
R13086 níquel mate	€ 120	➔
R13087 decoración de haya	€ 120	➔

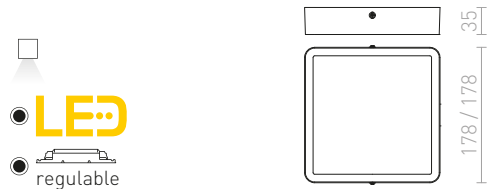

HUE SQ 22 DIMM DE TECHO

230 V LED 24 W 3000 K 2160 lm Ra 80

R13088 blanco	€ 138	➔
R13089 cromo negro	€ 129	➔
R13090 cromo	€ 129	➔
R13091 níquel mate	€ 129	➔

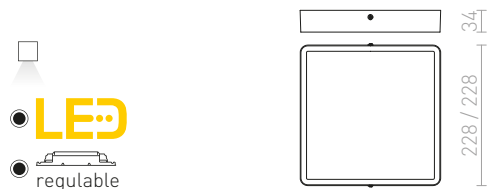





SOCORRO

Plafón llano montado en superficie con LED integrado.

SOCORRO R 300 MONTADAS EN SUPERFICIE

230 V LED 24 W 3000 K 1920 lm Ra 80

R12973 blanco

€ 58

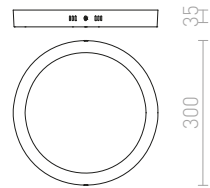

SLENDER

Plafón LED fino montado en superficie.

SLENDER R 12 MONTADAS EN SUPERFICIE

230 V LED 6 W 3000 K 540 lm Ra 80

R11281 níquel mate

€ 17

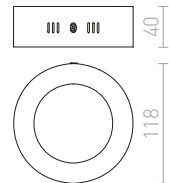
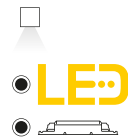

SLENDER SQ 12 MONTADAS EN SUPERFICIE

230 V LED 6 W 3000 K 540 lm Ra 80

R11284 níquel mate

€ 17

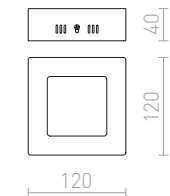
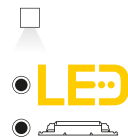

SLENDER SQ 22 MONTADAS EN SUPERFICIE

230 V LED 18 W 3000 K 1620 lm Ra 80

R11285 níquel mate

€ 32

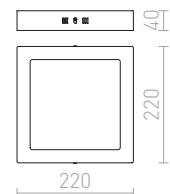
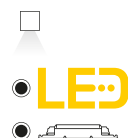







MELISA

Plafón montado en superficie con LED integrado, pantalla de acrílico esmerilado y marco de aluminio cepillado.

MELISA 25 DE TECHO

230 V LED 12 W 3000 K 840 lm Ra 80

R11296 aluminio

€ 58

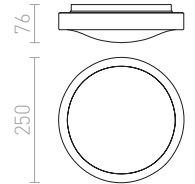
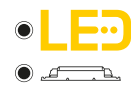

MELISA 52 DE TECHO

230 V LED 40 W 3000 K 2200 lm Ra 80

R11297 aluminio

€ 120

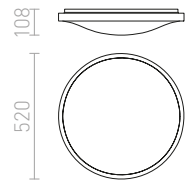

SEMPRE

Plafón con LED integrado y pantalla de acrílico esmerilado.

SEMPRE R 55 DE TECHO

230 V LED 56 W 3000 K 3920 lm Ra 80

R12434 acrílico esmerilado

€ 178

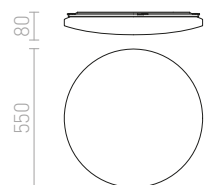

SEMPRE SQ 63 DE TECHO

230 V LED 76 W 3000 K 5320 lm Ra 80

R12439 acrílico esmerilado

€ 215

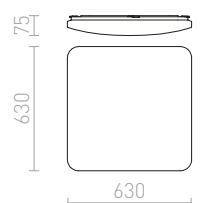





SEMPRE

Plafón de LED con pantalla de acrílico esmerilado y sensor de movimiento incorporado.

SEMPRE SQ 33 DE TECHO CON SENSOR

230 V LED 24 W 3000 K 1680 lm Ra 80

R12440 acrílico esmerilado

€ 120 

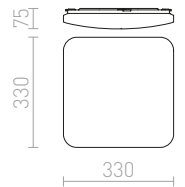

SEMPRE SQ 43 DE TECHO CON SENSOR

230 V LED 36 W 3000 K 2520 lm Ra 80

R12441 acrílico esmerilado

€ 150 

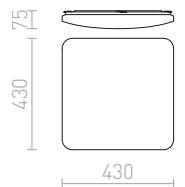

SEMPRE SQ 53 DE TECHO CON SENSOR

230 V LED 56 W 3000 K 3920 lm Ra 80

R12442 acrílico esmerilado

€ 188 

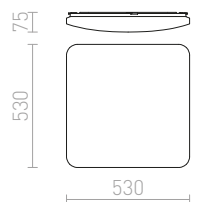

SEMPRE SQ 63 DE TECHO CON SENSOR

230 V LED 76 W 3000 K 5320 lm Ra 80

R12443 acrílico esmerilado

€ 129 

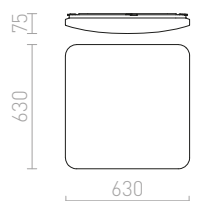



STRUCTURAL

Luminaria LED montada en superficie con marco de aluminio laqueado. Incluye un driver incorporado.

STRUCTURAL LED 60x15 MONTADAS EN SUPERFICIE

230 V LED 22 W 3000 K 1370 lm Ra 80

R12064 blanco

€ 120 %

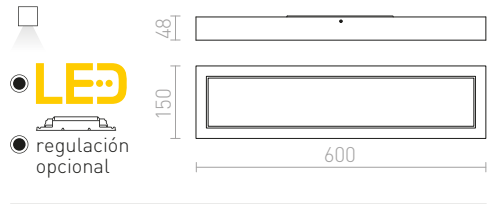

IP65

TRIDENT PRO

Luminaria industrial LED lineal para montaje en techo o suspensión mediante el kit G13672. Alto rendimiento y protección IP65. Se suministra sin kit de suspensión y cable de alimentación. Posibilidad de conectar luminarias en serie.

TRIDENT PRO 120 CUERPO

230 V LED 40 W 4000 K 5200 lm Ra 80 IP65

G13670 gris/acrílico mate

€ 58

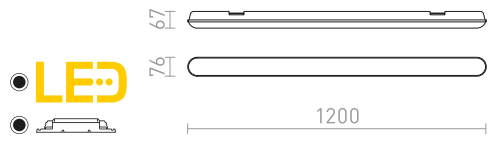

TRIDENT PRO 150 CUERPO

230 V LED 60 W 4000 K 7800 lm Ra 80 IP65

G13671 gris/acrílico mate

€ 88

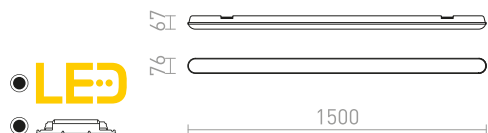



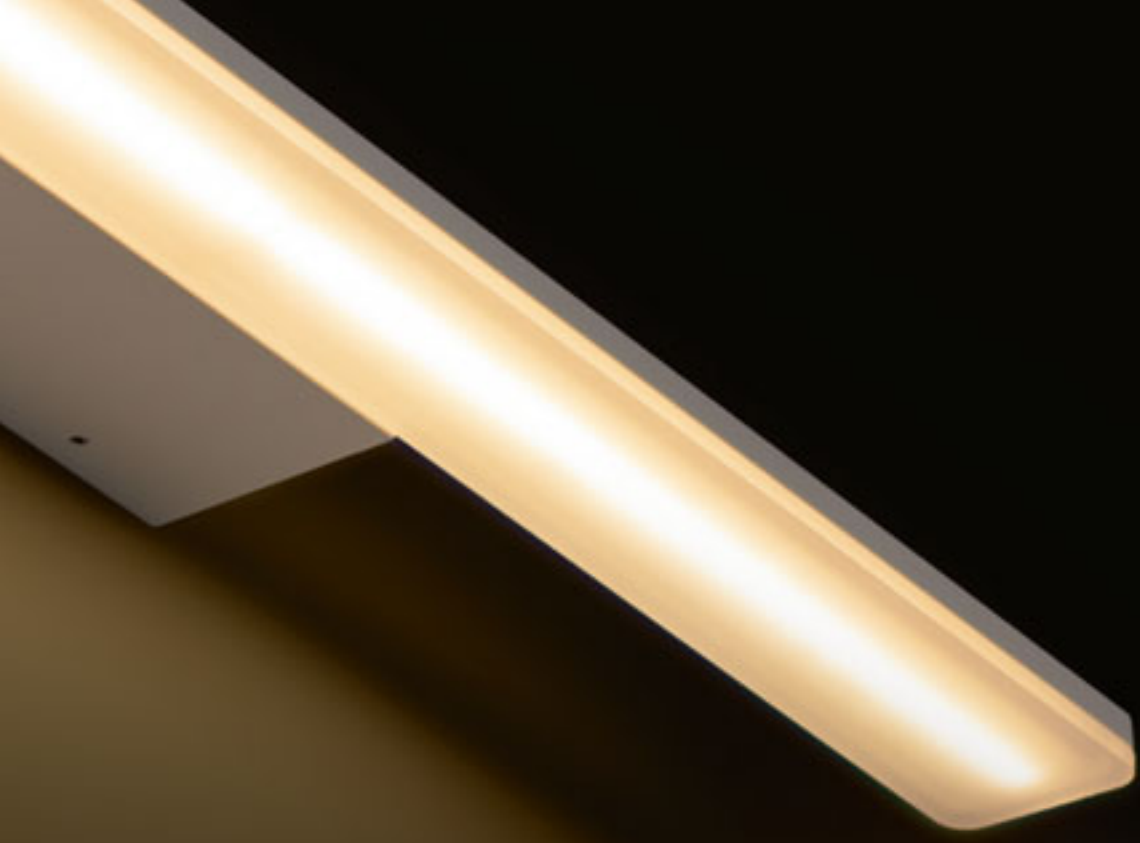

LÁMPARAS DE PARED

DE BAÑO	184-209
DECORATIVAS	210-219
COMBINADAS	220-223
CON UN BRAZO	224-227
DE YESO	228-237
INDIRECTA	238-239
ARRIBA - ABAJO	240-255
PARA CUADROS	256-259
PARA COCINA	260-261
ILUMINACIÓN ORIENTATIVA	262-265

PARED DE BAÑO

184-209



SWAY
184-185



PANON SHORT
184-185



PANON LONG
184-185



IMPERISO 60
184-185



MONET 84
186-187



LUIZA 60
186-187



CASSAMBA 60
186-187



PALEA 300
188-189



PALEA 500
188-189

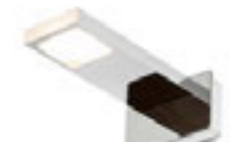

PARAGNA
188-189



MAREA 60
188-189



YOLO SQ
190-191



PARIS
190-191



SAVOY 24
190-191



BALEA 500
190-191



LEVIA 60
192-193



LEVIA 90
192-193



LEVIA 120
192-193



AMENITY 60
194-195



AMENITY 90
194-195



AMENITY 120
194-195



PERISA 60
194-195



PERISA 90
194-195



IMPERIA 90
196-197



IMPERIA 120
196-197



ADAGIO 60
196-197



MARINA LED 60
198-199



MARINA LED 90
198-199



MARINA LED 120
198-199



CRESCENDO 90
200-201



MIRANDA 60
200-201



MIRANDA 120
200-201



TAMPA 60
202-203



TAMPA
202-203



FLORIO 49
202-203



CORAZON 60
204-205



CORAZON 90
204-205



FAO 90
204-205



LINN I
206-207



LINN III
206-207



BOLLY III
206-207



VALTO I
206-207



VALTO III
206-207



DUBLIN I
208-209



DUBLIN II
208-209



DUBLIN III
208-209



DUBLIN IV
208-209

PARED DECORATIVAS

210-219



CALLUM RR4 250
210-211



CALLUM RL2 250
210-211



CALLUM RD2 250
210-211



GLANS RR2 150
212-213



GLANS RB2 165
212-213



RON W 15/25
214-215



LOPE W 25/14
214-215



SELENA
216-217



SOLARIS
216-217



JERSEY
218-219



SHARP
218-219



HUDSON
218-219

PARED COMBINADAS

220-223



VERSA
220-221



VERSINA
220-221



PERTH
220-221



TIARA
222-223



PLAZA
222-223



TAINA
222-223

PARED CON UN BRAZO

224-227



MADISON W
224-225



ASHLEY
224-225



MONTANA
226-227



ANTE
226-227

PARED DE YESO

228-237



GINA S
228-229



CHIC
228-229



BODIE
228-229



BENITA
228-229



GRANITA II
228-229



GAN
230-231



VERITA
230-231



COWLEY
230-231



CRESCENT
232-233



CRESCENT L
232-233



SID
232-233



JACK SQ
234-235



JACK RC S
234-235



HAY
234-235



KUBIS
234-235



ROLO 36
236-237



ROLO 45
236-237



WIM
236-237

**PARED
INDIRECTA**

238-239



FOND
238-239



BRUXEL 12
238-239



VIENNA
238-239



ATHI
238-239



ATLANTA 13
238-239

**PARED
ARRIBA - ABAJO**

240-255



TITO R
240-241



TITO SQ
240-241



CARRE
240-241



DAFFY
242-243



BIARITZ
242-243



TUBA W
242-243



MIDZACK
242-243



MOIRE I
244-245



MOIRE II
244-245



MICO I
244-245



MICO II
244-245



MARIO
246-247



REEM
246-247



ROZA
246-247



TAPA
246-247



NAXOS
246-247



TRIP SQ
248-249



ESSEX
248-249



ONYX
248-249



DIDO
248-249



KORSO II
248-249



PEKKO
248-249



AGATE II
250-251



DESMOND II
250-251



NICK II
250-251



UKKO
250-251



CHLOE
252-253



LEA
252-253



TORINO
252-253



NEMAN
252-253



TWIST
254-255



PRIO LED 62
254-255

PARED PARA CUADROS



SWAY
256-257



SWING
256-257



PANON LONG
256-257

256-259



LUISA 60
258-259



IMPERISO 60
258-259



MAREA 60
258-259

PARED PARA COCINA

260-261



FLORIO 49
260-261



CORAZON 60
260-261



CORAZON 90
260-261

PARED ILUMINACIÓN ORIENTATIVA

262-265



AQILA R
262-263



AQILA RC
262-263



AMBER
262-263



TICO I
262-263



AQILA SQ
262-263



BOBO R
264-265



BOBO RC
264-265



BOBO SQ
264-265



IP44



IP44

PANON

Aplique LED lineal con base central. Adecuado para uso en ambientes húmedos.

PANON SHORT DE PARED

230 V LED 18 W 3000 K 1700 lm Ra 80 IP44

R12949 cromo

€ 138

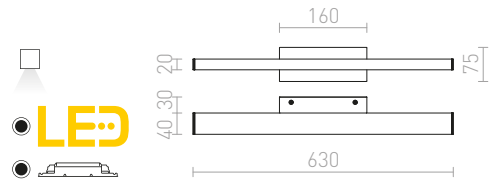

PANON LONG DE PARED

230 V LED 12 W 3000 K 900 lm Ra 80 IP44

R12950 cromo

€ 120





IP44

SWAY

Aplique LED lineal inclinable, adecuado para uso sobre cuadros y espejos.

SWAY BAÑO

230 V LED 12 W 3000 K 1060 lm Ra 80 IP44

R12951 cromo

€ 120

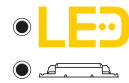
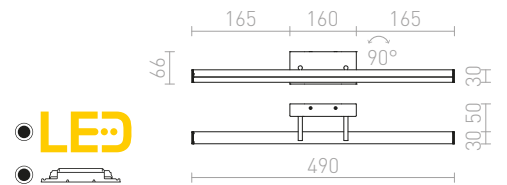

IP44

IMPERISO

Luminaria LED lineal adecuado para uso sobre espejos. La parte frontal de la luminaria se puede girar en el eje horizontal. Para uso en ambientes húmedos.

IMPERISO 60

230 V LED 18 W 3000 K 1769 lm Ra 80 IP44

R13555 blanco

€ 248

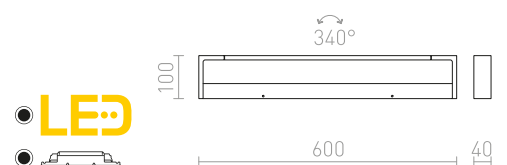



IP44



MONET

Lámpara de LED horizontal por encima del espejo, apropiada para áreas húmedas.

MONET 84 APLIQUE DE PARED

230 V LED 29 W 3000 K 1892 lm Ra 80 IP44

R13337 acrílico esmerilado/cromo

€ 278 →



LED

50

250

87

835





IP54

LUISA

Luminaria LED lineal con iluminación descendente, adecuado para uso sobre el espejo. Para uso en ambientes húmedos.

LUISA 60 DE PARED

230 V LED 12 W 3000 K 1138 lm Ra 80 IP54

R13735 blanco

€ 150

R13853 negro

€ 150

NEW

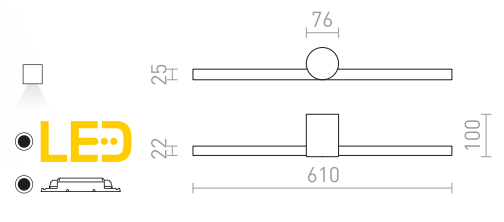

IP44

CASSAMBA

Lámpara de pared en forma de tubo con LED incorporado sobre base oblonga, apta para baños. El color de la temperatura de la luz puede cambiarse utilizando un interruptor en el interior de la base: 3000K o 4000K.

CASSAMBA 60 DE PARED

230 V LED 12 W 3000 K 4000 K 700 lm Ra 80 IP44

R13888 negro/acrílico esmerilado

€ 178

NEW

R13889 cromo/acrílico esmerilado

€ 178

NEW

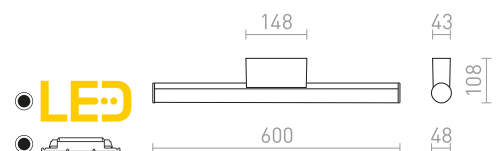



IP44

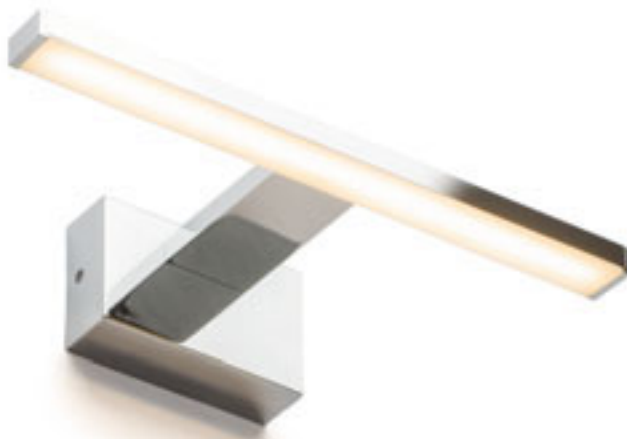

IP44



IP44

PALEA

Aplique para baño con tecnología LED. Adecuado para uso en ambientes húmedos.

PALEA 500

230 V LED 7 W 3000 K 308 lm Ra 80 IP44

R10613 cromo

€ 150

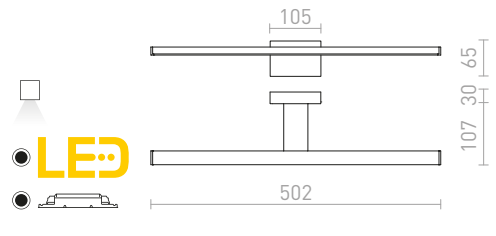

PALEA 300

230 V LED 4,4 W 3000 K 189 lm Ra 80 IP44

R10614 cromo

€ 120

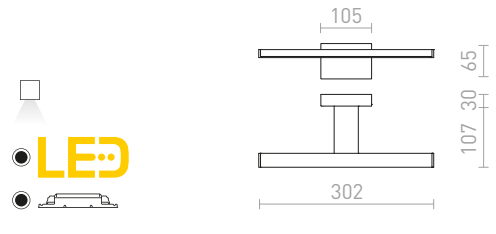

PARAGNA

Lámpara de pared para baño con tecnología LED.

PARAGNA DE PARED

230 V LED 5,7 W 3000 K 246 lm Ra 80 IP44

R10612 cromo

€ 78

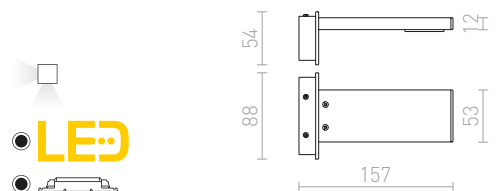



IP44

MAREA

Luminaria LED lineal con iluminación descendente, apta para uso sobre el espejo. Para uso en ambientes húmedos.

MAREA 60 DE PARED

230 V LED 18 W 3000 K 1954 lm Ra 80 IP44

R13554 blanco

€ 188

R13852 negro

€ 188

NEW

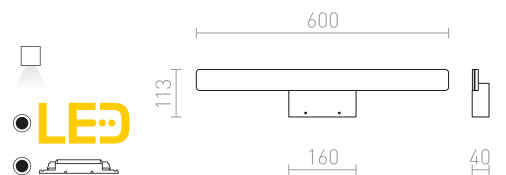

IP44

PARIS

Luz de baño con LED integrado en metal sólido cromado, adecuada para gabinetes y estantes de baño.

PARIS PARA GABINETES

230 V LED 3 W $\angle 120^\circ$ 3000 K 210 lm Ra 80 IP44

R12398 cromo

€ 68

%

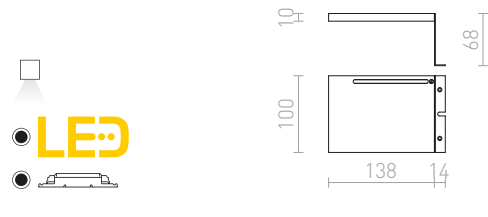

IP44

SAVOY

Luz LED metálica rectangular en acabado cromado con iluminación ARRIBA/ABAJO, adecuada para gabinetes y estantes de baño.

SAVOY 24 PARA GABINETES

230 V LED 8 W $\angle 120^\circ$ 3000 K 300 lm Ra 80 IP44

R12399 cromo

€ 88

%

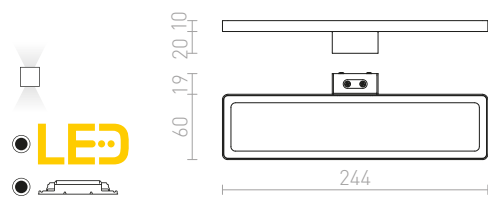

IP44

BALEA

Luminaria lineal para baño con LED incorporado y brazo para montaje en gabinetes o estantes.

BALEA 500 PARA GABINETES

230 V LED 7 W $\angle 120^\circ$ 3000 K 370 lm Ra 80 IP44

R12400 cromo

€ 120

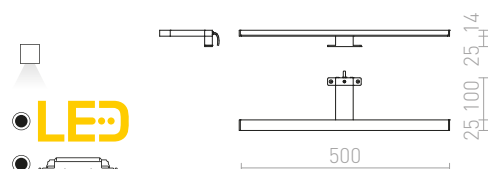



IP44



YOLO

Luminaria LED de baño para montaje en armarios y espejos.

YOLO SQ SOBRE ESPEJO

12 V= LED 4 W 3000 K 215 lm Ra 80 IP44

R10588 cromo

€ 48



LED



G14018

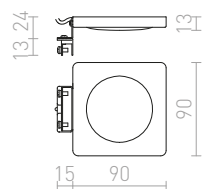



LEVIA

Luminaria de pared lineal con LED integrado adecuada para ambientes húmedos. La luz se puede montar en un gabinete o estante utilizando los soportes R12581.

LEVIA 60 DE PARED

230 V LED 12 W $\angle 120^\circ$ 3000 K 900 lm Ra 80 IP44

R12401 aluminio

€ 150

R12402 cromo

€ 150

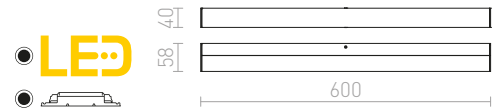

LEVIA 90 DE PARED

230 V LED 18 W $\angle 120^\circ$ 3000 K 1300 lm Ra 80 IP44

R12403 aluminio

€ 198

R12404 cromo

€ 215



LEVIA 120 DE PARED

230 V LED 24 W $\angle 120^\circ$ 3000 K 1700 lm Ra 80 IP44

R12405 aluminio

€ 248

R12406 cromo

€ 258

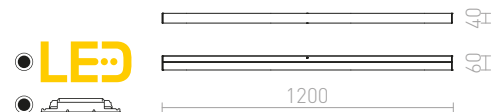

IP44

IP44

IP44

LEVIA

Soportes cromados para montaje en gabinete: R12401, R12402, R12403, R12404, R12405 y R12406.

LEVIA JUEGO DE MANIJAS PARA GABINETES

R12581 cromo

€ 3.80

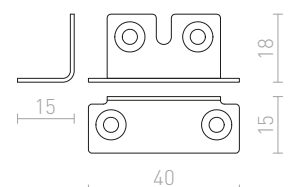



IP44



IP44

PERISA

Luminaria lineal para tubos fluorescentes, ideal sobre espejos. Disponible en aluminio cepillado o con acabado lacado blanco. Apta para ambientes húmedos.

PERISA 60 DE PARED

230 V G5 14 W IP44

R10262 blanco

€ 98

%

R10264 aluminio cepillado

€ 120

%



PERISA 90 DE PARED

230 V G5 21 W IP44

R10263 blanco

€ 78

%

R10265 aluminio cepillado

€ 120

%

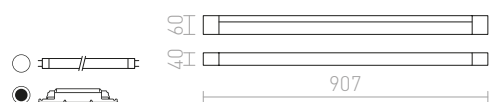



IP44



IP44



IP44



AMENITY

Lámpara de baño LED lineal montada en la pared con puntas de cromo. Adecuada para ambientes húmedos.

AMENITY 120 DE PARED

230 V LED 14 W 3000 K 830 lm Ra 80 IP44

R12641 cromo

€ 229

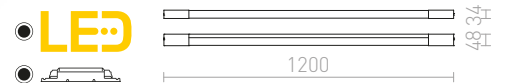

AMENITY 90 DE PARED

230 V LED 11 W 3000 K 580 lm Ra 80 IP44

R12640 cromo

€ 215



AMENITY 60 DE PARED

230 V LED 8 W 3000 K 400 lm Ra 80 IP44

R12639 cromo

€ 178







IP44

ADAGIO

Luminaria cuadrada de baño con tapa de plástico y accesorios cromados. Adecuada para ambientes húmedos.

ADAGIO 60 DE PARED

230 V G5 24 W IP44

R12217 cromo

€ 120 %

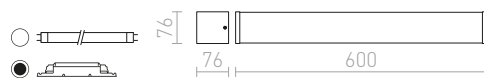

IP44

IMPERIA

Luminaria de baño rectangular con tapa de plástico y accesorios cromados.

IMPERIA 120 DE PARED

230 V G5 28 W IP44

R12219 cromo

€ 158 %



IP44

IMPERIA 90 DE PARED

230 V G5 39 W IP44

R12218 cromo

€ 150 %



IP44



IP44

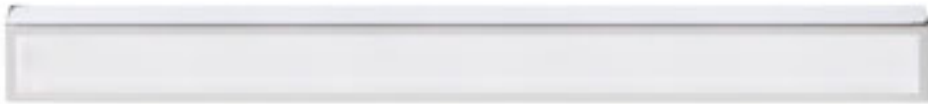

IP44

MARINA

Luminaria lineal de pared con LED integrado para iluminación ARRIBA / ABAJO. Apta para ambientes húmedos.

MARINA LED 60 DE PARED

230 V LED 14 W 3000 K 550 lm Ra 80 [IP44](#)

R11993 cromo

€ 178



45



80

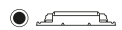

600

MARINA LED 90 DE PARED

230 V LED 19 W 3000 K 800 lm Ra 80 [IP44](#)

R11996 cromo

€ 238



45



80

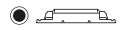

900

MARINA LED 120 DE PARED

230 V LED 25 W 3000 K 950 lm Ra 80 [IP44](#)

R11998 cromo

€ 360



45



80



1200







IP44

MIRANDA

Luminaria LED de baño lineal para ambientes húmedos.

MIRANDA 60 DE PARED

230 V LED 8 W 3000 K 470 lm Ra 80 IP44

R12407 cromo

€ 150

%

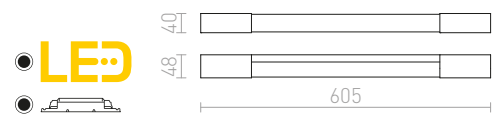

IP44

MIRANDA 120 DE PARED

230 V LED 14 W 3000 K 1000 lm Ra 80 IP44

R12409 cromo

€ 220

%



IP44

CRESCENDO

Luminaria de baño redonda con tapa de plástico y detalles cromados. Apta sobre espejos.

CRESCENDO 90 DE PARED

230 V G5 39 W IP44

R12220 cromo

€ 150

%





IP44



FLORIO

Luminaria para baño con LED integrado y una toma de bajo consumo de energía de hasta 100W.

FLORIO 49

230 V LED 8 W 3000 K 640 lm Ra 80 IP44

R12903 blanco

€ 88

R12904 cromo

€ 98

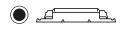

IP44

TAMPA

Luminaria lineal de baño con LED incorporado, ideal sobre espejos y con la opción de adquirir los extremos en diferentes colores (R12906, R12907, R12908).

TAMPA 60 DE PARED SIN TAPA FINAL

230 V LED 15 W 3000 K 1400 lm Ra 80 IP44

R12905 blanco

€ 68

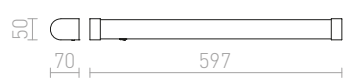
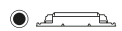

TAMPA

Piezas finales separadas en tres colores para usar con R12905.

TAMPA TAPAS DE EXTREMO 2 PIEZAS

R12906 blanco

€ 2.20

R12907 gris plata

€ 3.80

R12908 cromo

€ 5.50

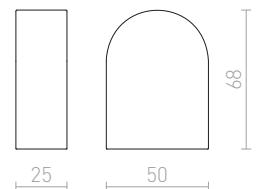







IP44

FAO

Luminaria lineal montada en superficie con cubierta acrílica esmerilada adecuada para ambientes húmedos.

FAO 90 DE PARED

230 V G5 21 W IP44

R10491 cromo

€ 78 %



IP44

CORAZON

Luminaria lineal con LED integrado adecuada para ambientes húmedos.

CORAZON 60

230 V LED 15 W 3000 K 1200 lm Ra 80 IP44

R12901 cromo

€ 78

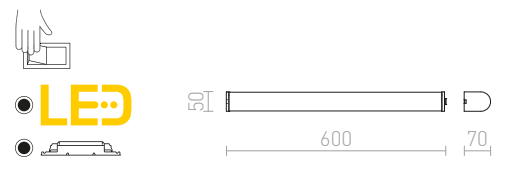

IP44

CORAZON 90

230 V LED 20 W 3000 K 1600 lm Ra 80 IP44

R12902 cromo

€ 120

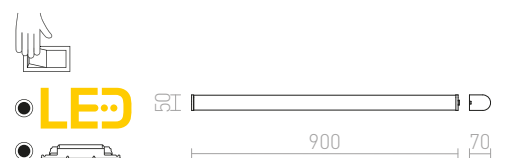



IP44



IP44

LINN

Luminarias de pared o techo con cristal opalino sobre base cromada. Apto para ambientes húmedos.

LINN III MONTADAS EN SUPERFICIE

230 V G9 LED 3x3 W IP44

R13703 vidrio opal/cromo

€ 120

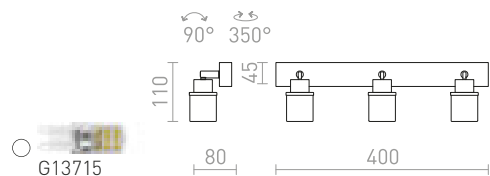

LINN I DE PARED

230 V G9 LED 3 W IP44

R13695 vidrio opal/cromo

€ 48

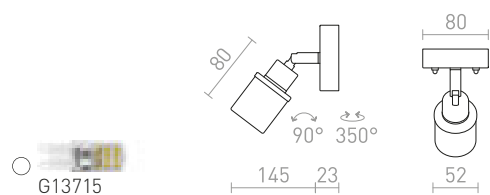



IP44



BOLLY

Luminaria de pared o techo con cristal opalino sobre base cromada. Adecuada para ambientes húmedos.

BOLLY III MONTADAS EN SUPERFICIE

230 V G9 LED 3x3 W IP44

R13691 vidrio opal/cromo

€ 129

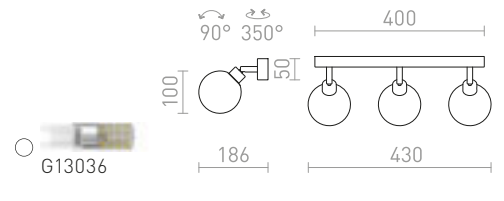

IP44

VALTO

Luminarias de pared o techo con reflector basculante para bombillas LED con casquillo GU10. Apto para ambientes húmedos.

VALTO III MONTADAS EN SUPERFICIE

230 V GU10 LED 3x5 W IP44

R13704 cromo

€ 88

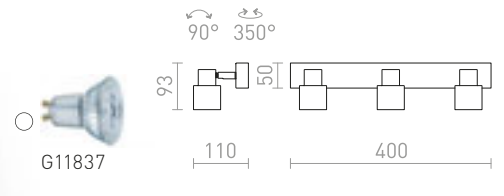

IP44

VALTO I DE PARED

230 V GU10 LED 5 W IP44

R13696 cromo

€ 48

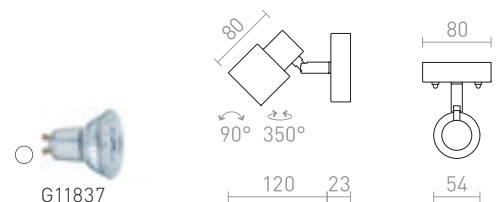





IP44

DUBLIN

Foco cromado adecuado para zonas húmedas.

DUBLIN I MONTADO EN SUPERFICIE

230 V GU10 9 W IP44

R13377 cromo

€ 48

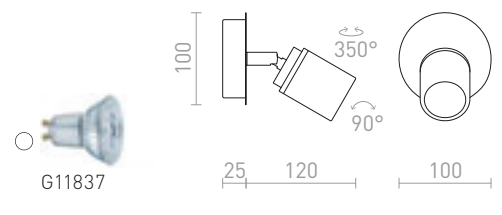

IP44

DUBLIN II MONTADO EN SUPERFICIE

230 V GU10 2x9 W IP44

R13378 cromo

€ 78

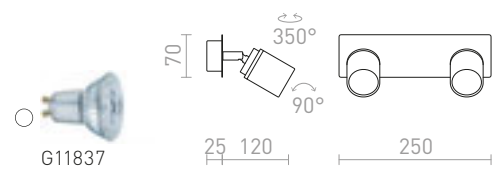

IP44

DUBLIN III MONTADO EN SUPERFICIE

230 V GU10 3x9 W IP44

R13379 cromo

€ 98

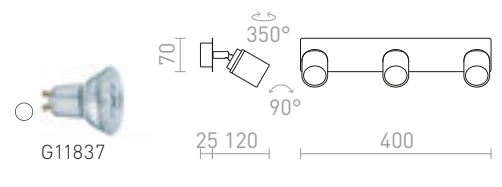

IP44

DUBLIN IV MONTADO EN SUPERFICIE

230 V GU10 4x9 W IP44

R13380 cromo

€ 129

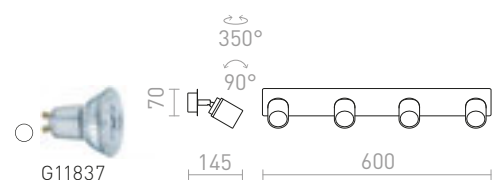





CALLUM

Lámpara de pared creada por impresión 3D. La pantalla está hecha de material PLA ecológico, el cual es totalmente degradable.

CALLUM RD2 250 DE PARED

230V LED E27 10W

R13999 blanco/Eco PLA

€ 129

NEW

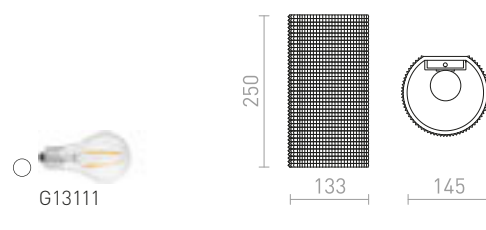

CALLUM RR4 250 DE PARED

230V LED E27 10W

R13997 blanco/Eco PLA

€ 129

NEW

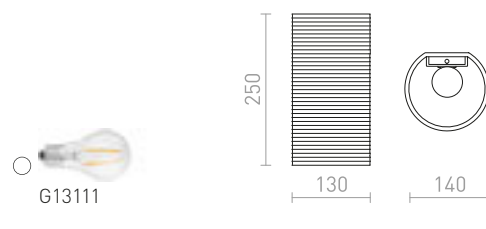

CALLUM RL2 250 DE PARED

230V LED E27 10W

R13998 blanco/Eco PLA

€ 129

NEW

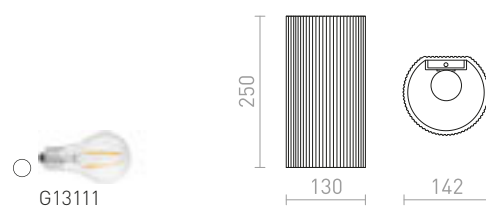



GLANS

Lámpara de pared creada por impresión 3D.
La pantalla está hecha de material PLA ecológico, el cual es totalmente degradable.

GLANS RB2 165 DE PARED

230 V LED G9 5 W

R14001 blanco/Eco PLA

€ 120 **NEW**

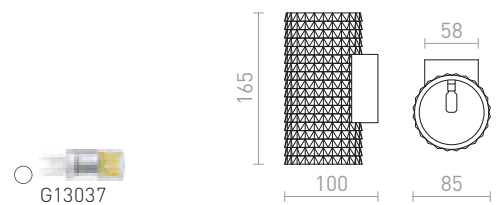

GLANS RR2 150 DE PARED

230 V LED G9 5 W

R14000 blanco/Eco PLA

€ 120 **NEW**

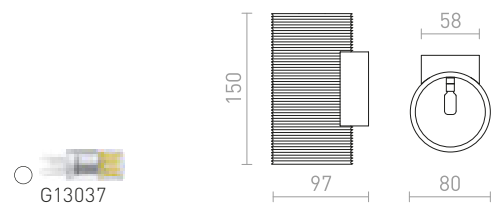





RON

Lámpara de pared con pantalla textil.

RON W 15/25 DE PARED

230 V E27 28 W

	R11368 polialgodón negro/hoja de cobre	€ 158
	R11464 polialgodón negro/hoja dorada	€ 158
	R11492 polialgodón blanco/PVC blanco	€ 120
	R11509 albaricoque Chintz/PVC blanco	€ 120
	R11519 Chintz naranja/PVC blanco	€ 120
	R11548 menta de Chintz/hoja de plata	€ 129
	R11557 Chintz gris claro/PVC blanco	€ 120
	R11567 Chintz lima/PVC blanco	€ 120
	R11575 monaco gasolina azul/plata PVC	€ 129
	R11586 monaco paloma gris/plata PVC	€ 129

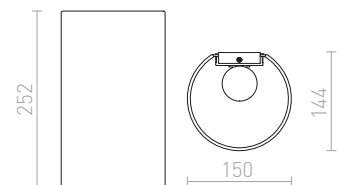



LOPE

Lámpara de pared con pantalla textil.

LOPE W 25/14 DE PARED

230 V E27 28 W

	R11365 polialgodón negro/hoja dorada	€ 150
	R11377 polialgodón negro/hoja de cobre	€ 150
	R11381 aceituna de Chintz/hoja de plata	€ 78 %
	R11383 menta de Chintz/hoja de plata	€ 150
	R11504 polialgodón blanco/PVC blanco	€ 120
	R11512 albaricque Chintz/PVC blanco	€ 120
	R11522 Chintz naranja/PVC blanco	€ 120
	R11560 Chintz gris claro/PVC blanco	€ 120
	R11570 Chintz lima/PVC blanco	€ 120

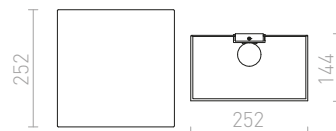



SELENA

Lámpara textil de pared con pulsador. La pantalla se puede girar en un eje.

SELENA MURO

230 V E27 15 W

R13651 negro

€ 120 



G13014

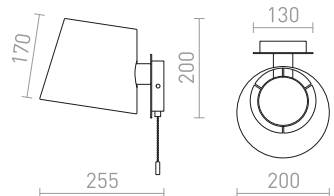



SOLARIS

Lámpara de superficie de cristal con base lacada en negro. Apto para fuentes de luz LED con rosca E14.

SOLARIS PARED O TECHO

230 V LED E14 7 W

R13994 vidrio transparente/negro

€ 78 NEW

R13995 vidrio escarchado/negro

€ 78 NEW

R13996 vidrio de color humo/negro

€ 78 NEW



G13098

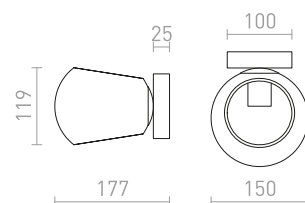



HUDSON

Aplique de pared con brazo cromado y cable vertical, acabado con pantalla cilíndrica textil.

HUDSON DE PARED

230 V E27 28 W

R13284 blanco/cromo

€ 138

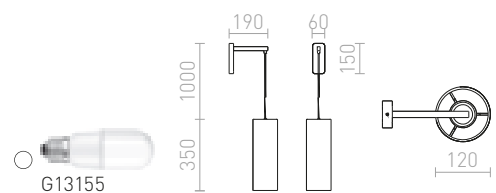



SHARP

Lámpara de pared con pantalla textil e interruptor en la base.

SHARP DE PARED

230 V E27 42 W

R12481 negro/cromo

€ 78



G13026

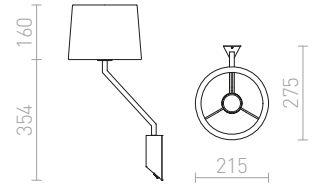

JERSEY

Elegante lámpara de pared con pantalla inclinable que está cubierta con un tejido estructurado.

JERSEY DE PARED

230 V E27 42 W

R11976 blanco/cromo

€ 178



G13026

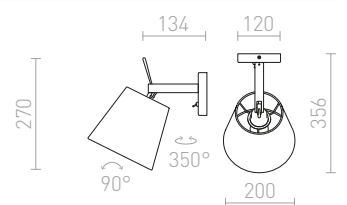



VERSA

Lámpara de pared con pantalla textil que lleva un brazo flexible adicional, el cual tiene un reflector LED. La luminaria tiene dos fuentes de luz que pueden ser reguladas por separado mediante un interruptor de palanca situada en su base circular.

VERSA DE PARED CON PANTALLA

230 V E27 LED 42 W + 3 W $\angle 40^\circ$ 3000 K 240 lm Ra 80

R10580 blanco/níquel mate

€ 178



G13026
LED

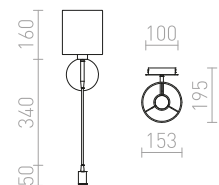

VERSINA

Lámpara de pared con pantalla textil, con un brazo flexible que tiene un reflector LED. La luminaria tiene dos fuentes de luz que se pueden regular por separado mediante interruptores ubicados en su base de forma circular.

VERSINA CON PANTALLA

230 V E27 LED 28 W + 3 W $\angle 25^\circ$ 3000 K 180 lm Ra 80

R12955 blanco/cromo

€ 129



G13026
LED

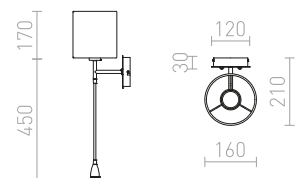

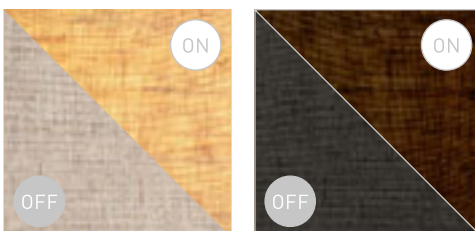

PERTH

Aplique de pared con pantalla textil cuadrada, con brazo flexible con reflector LED. La luminaria tiene dos fuentes de luz que se pueden controlar por separado mediante un interruptor giratorio ubicado en la base cuadrada de la luminaria.

PERTH PARED CON FOCO LED

230 V E14 LED 15 W + 3 W $\angle 30^\circ$ 3000 K 150 lm Ra 80

R13661 beige/blanco/cromo

€ 178

R13662 negro/negro/cromo

€ 178



G13572

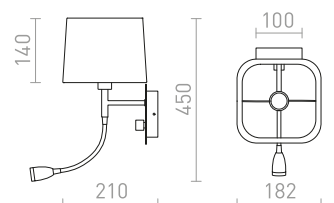



PLAZA

Lámpara de pared con pantalla textil estructurada y fuentes de luz LED 3W para lectura. Ambas son regulables por separado mediante dos interruptores que se encuentran en la base.

PLAZA DE PARED CON LUZ LED

230 V E27 LED 42 W + 3 W 3000 K 140 lm Ra 80

R11982 blanco/cromo

€ 188



G13026

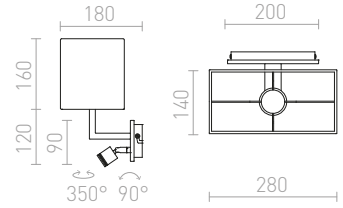

TIARA

Lámpara de pared con dos fuentes de luz LED integradas, las cuales pueden ser reguladas por separado mediante interruptores situados en la base de la luminaria.

TIARA DE PARED

230 V LED 2x3 W ∠25° 3000 K 300 lm Ra 80

R12957 cromo

€ 68

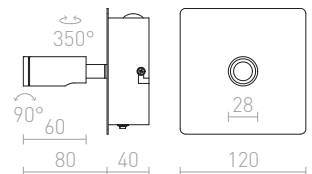
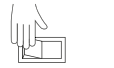

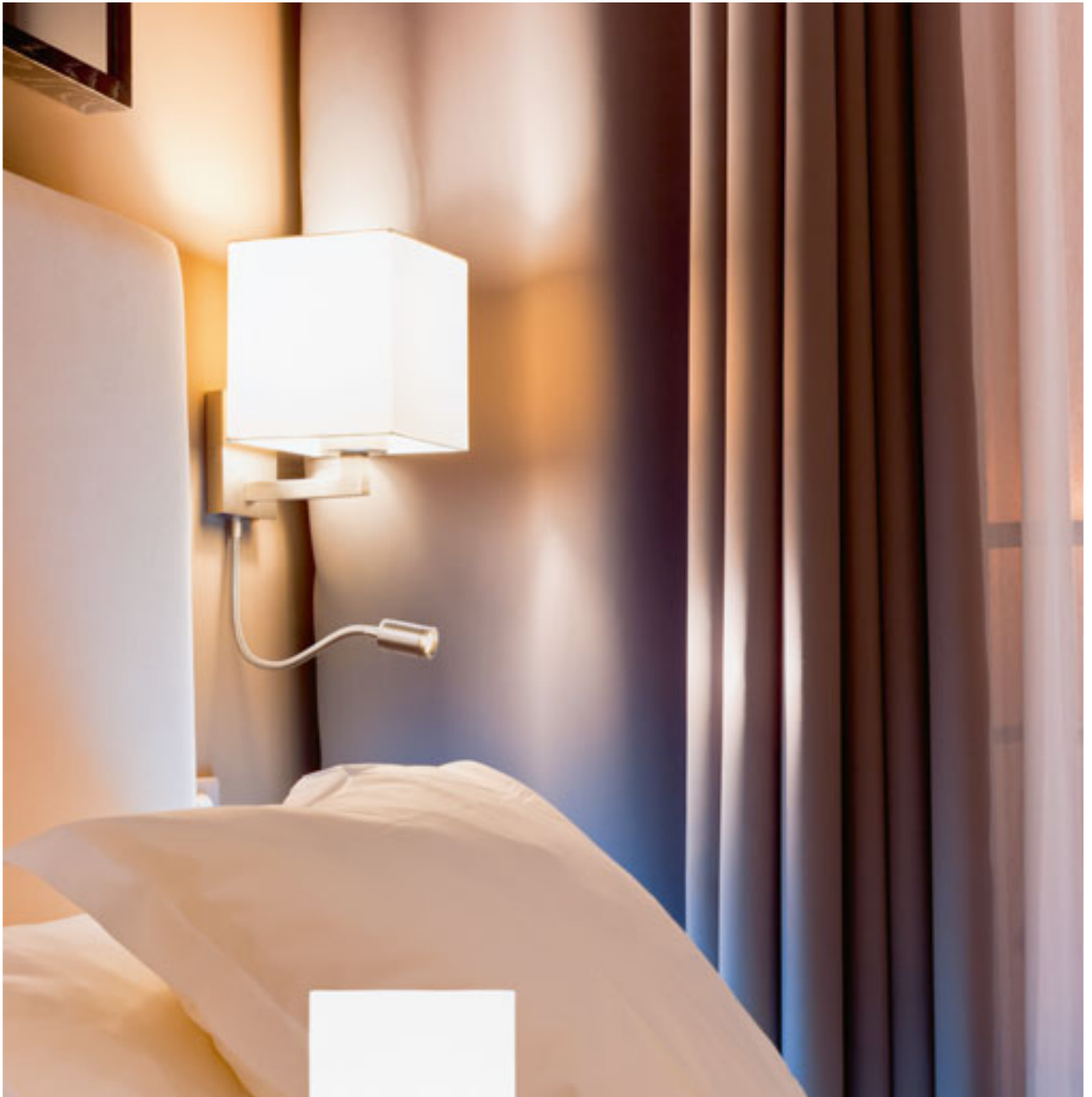

TAINA

Lámpara de pared con pantalla textil, con un brazo flexible que lleva un reflector LED. Las dos fuentes de luz pueden ser reguladas por separado, mediante interruptores que se encuentran en la base de la luminaria.

TAINA CON PANTALLA

230 V E27 LED 28 W+3 W $\angle 25^\circ$ 3000 K 180 lm Ra 80

R12956 blanco/níquel mate

€ 138

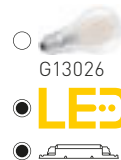

G13026
LED

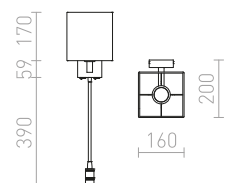



MADISON

Lámpara de pared con pantalla textil y brazo articulado.

MADISON W DE PARED

230 V E27 42 W

R12480 blanco/cromo

€ 420

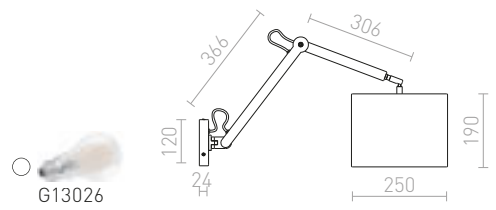

ASHLEY

Lámpara de pared doble con pantalla textil e interruptor en la base.

ASHLEY DE PARED

230 V E27 42 W

R12482 blanco/cromo

€ 435

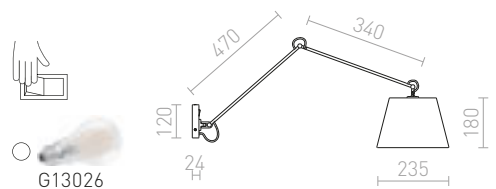
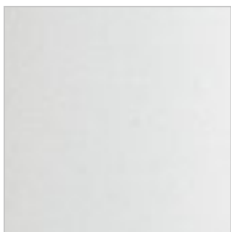







MONTANA

Lámpara de pared con brazo regulable y pantalla textil.

MONTANA DE PARED

230 V E27 28 W

R13282 blanco/negro/cromo

€ 258



G13014

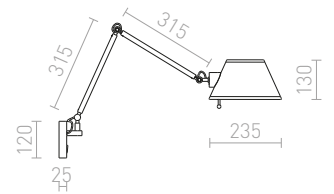

ANTE

Lámpara ajustable montada en la pared con interruptor en la base.

ANTE DE PARED

230 V E27 28 W

R12651 negro/cobre

€ 98

R12652 blanco/níquel mate

€ 98



G13026

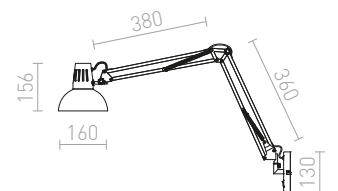



IP65

GRANITA

Aplique de exterior hecho de hormigón para fuentes de luz LED con casquillo GU10.

GRANITA II DE PARED

230 V LED GU10 2x5 W IP65

R13792 hormigón/decoración de granito claro € 120

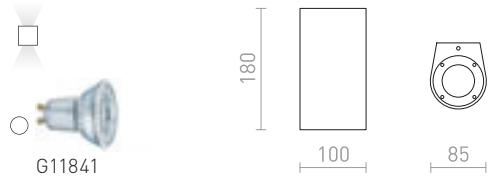

GINA

Aplique de yeso para fuentes de luz G9. La luminaria se puede pintar con pintura para interiores.

GINA S DE PARED

230 V G9 33 W

R11959 yeso € 58

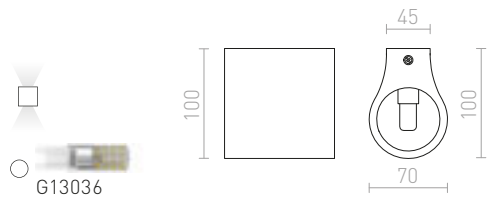

CHIC

Luminaria de pared hecha de yeso para la iluminación indirecta. La lámpara se puede pintar con pintura para interiores.

CHIC DE PARED

230 V G9 25 W

R12999 yeso € 58

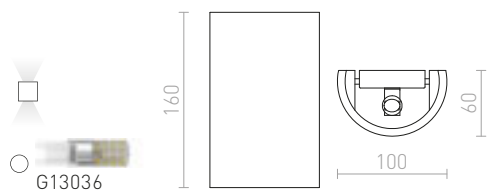

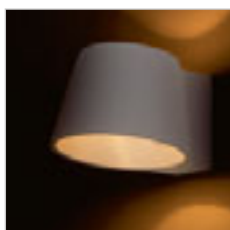

BENITA

Aplique de yeso para fuentes de luz E14. Se puede pintar con pintura para paredes.

BENITA DE PARED

230 V E14 25 W

R13520 yeso

€ 88

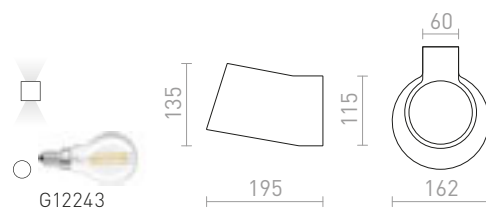

BODIE

Lámpara LED de pared hecha de yeso con iluminación ARRIBA/ABAJO. La luminaria se puede pintar con pintura para interiores. Incluye un controlador incorporado.

BODIE APLIQUE DE PARED

230 V LED 2x3 W 3000 K 480 lm Ra 80

R13433 yeso

€ 120

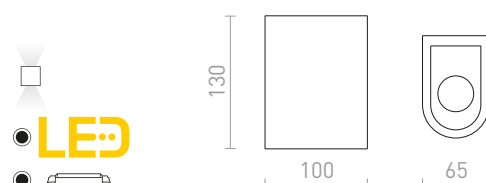



GAN

Lámpara de pared hecha de yeso con iluminación ARRIBA/ABAJO. La luminaria se puede pintar con pintura para interiores.

GAN DE PARED

230 V G9 33 W

R12039 yeso

€ 78



COWLEY

Aplique de pared de yeso con iluminación ARRIBA/ABAJO. La parte inferior está cubierta de vidrio de satén. La superficie se puede pintar con pintura para interiores.

COWLEY APLIQUE DE PARED

230 V G9 2x28 W

R13435 yeso

€ 88

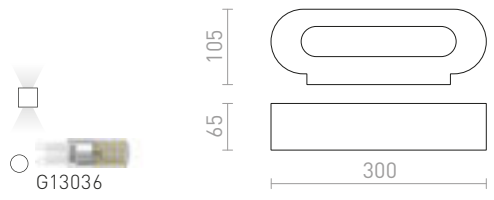

VERITA

Luminaria redonda de pared hecha de yeso con luz ARRIBA/ABAJO con casquillo E27. La luminaria se puede pintar con pintura para interiores.

VERITA DE PARED

230 V E27 33 W

R12365 yeso

€ 120

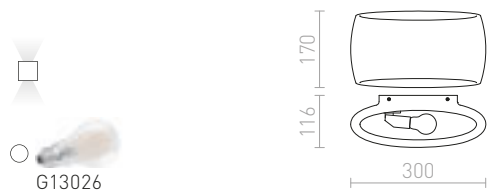





CRESCENT

Lámpara de pared hecha de yeso con iluminación ARRIBA/BAJO. En la parte inferior hay una cubierta de vidrio satinado. La luminaria puede ser pintada con pintura para interiores.

CRESCENT L DE PARED

230 V E14 2x28 W

R10451 yeso

€ 129



G11849

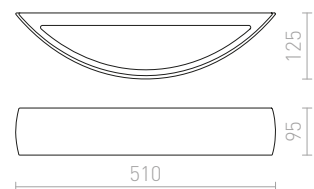

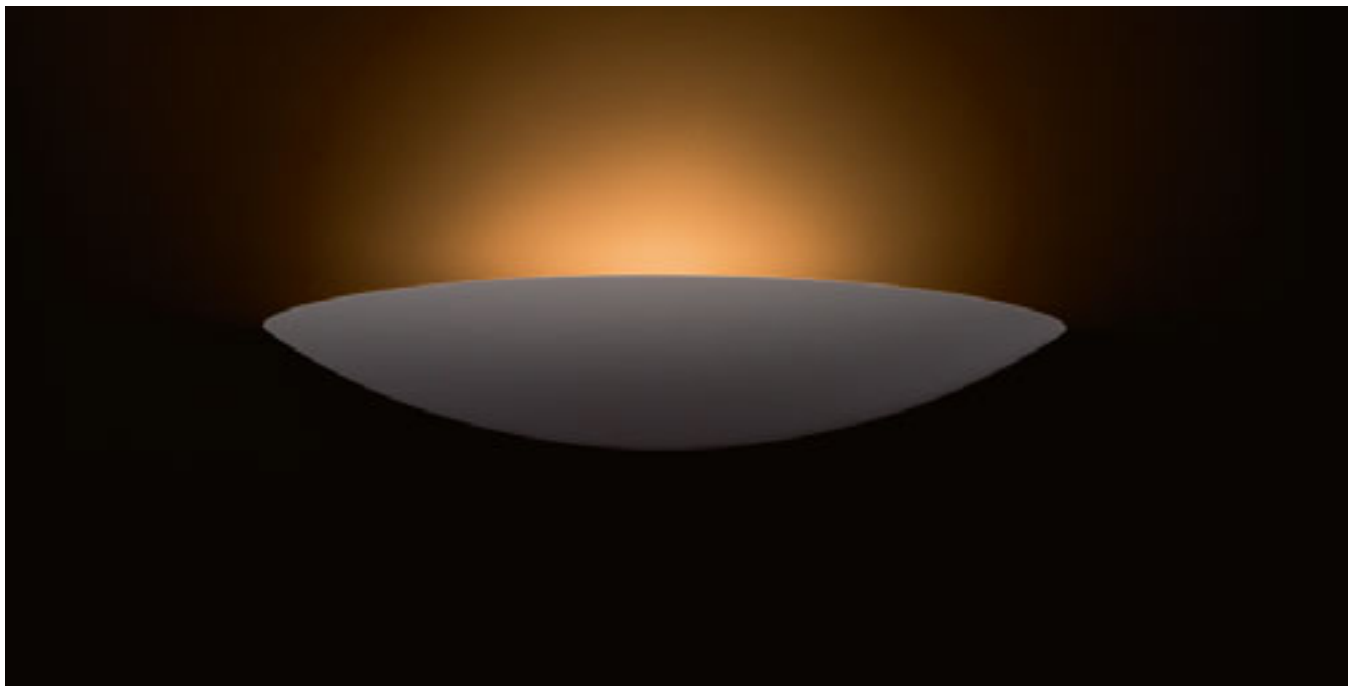

SID

Luminaria de pared, de yeso para la iluminación indirecta. La luminaria se puede pintar con pintura para interiores.

SID DE PARED

230 V R7s 78mm 48 W

R12998 yeso

€ 88

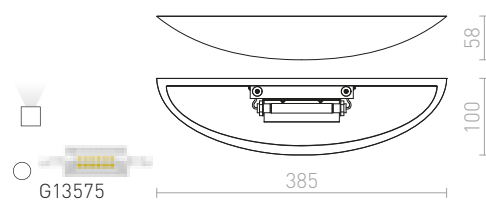

CRESCENT

Lámpara de pared, hecha de yeso con iluminación ARRIBA/ABAJO. En la parte inferior hay una cubierta de vidrio satinado. La luminaria R10266 está diseñada para utilizar el halógeno lineal de 78 mm. La luminaria puede ser pintada con pintura para interiores.

CRESCENT DE PARED

230 V R7s 78mm 80 W

R10266 yeso

€ 88

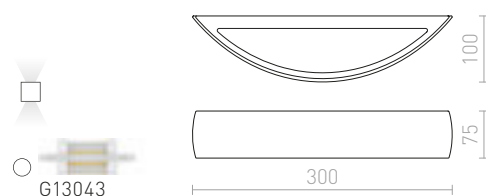



JACK

Lámpara de pared de yeso, con iluminación ARRIBA/ ABAJO. La luminaria se puede colorear con pintura para interiores.

JACK SQ DE PARED

230 V G9 40 W

R10445 yeso

€ 58

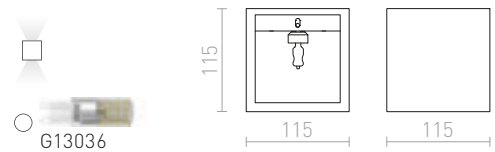

JACK RC S DE PARED

230 V G9 33 W

R11960 yeso

€ 48

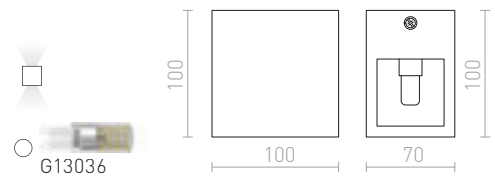

HAY

Luminaria de pared hecha de yeso. La lámpara se puede pintar con pintura para interiores.

HAY DE PARED

230 V G9 40 W

R10448 yeso

€ 48 %

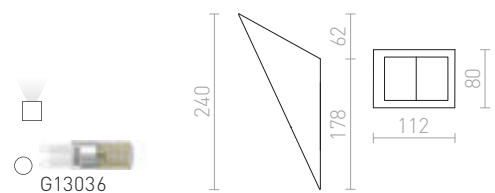



KUBIS

Luminaria de pared hecha de yeso y de forma asimétrica. El hoyo más estrecho debe ser montado hacia arriba. La lámpara se puede pintar con pintura para interiores. Dimensiones de la base L / A / P 10/5/2 cm, dimensiones de los hoyos L1 / A1 10 / 5.5 cm, L2 / A2 7/8 cm.

KUBIS DE PARED

230 V G9 40 W

R10455 yeso

€ 48 

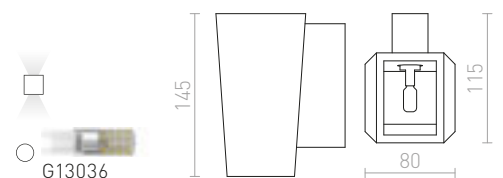



WIM

Luminaria de pared hecha de yeso. La lámpara se puede pintar con pintura para interiores.

WIM DE PARED

230 V G9 2x40 W

R10465 yeso

€ 68

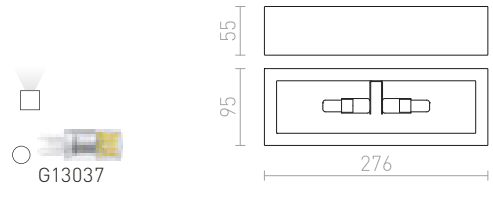

ROLO

Aplique de yeso bidireccional UP/DOWN. La parte inferior del dispositivo está cubierta de vidrio satinado. Aplique se puede colorear con pintura de pared para interiores.

ROLO 45 APLIQUE DE PARED

230 V E14 2x11 W

R13436 yeso

€ 120

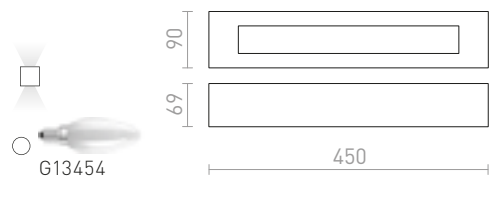

ROLO 36 DE PARED

230 V E14 2x30 W

R10446 yeso

€ 68

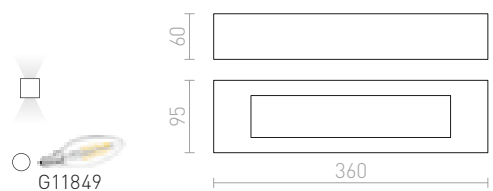





FOND

Luminaria LED rectangular, de pared para iluminación indirecta.

FOND DE PARED

230 V LED 12 W 3000 K 1300 lm Ra 80

R12596 blanco

€ 120

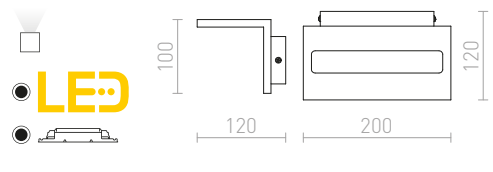

BRUXEL

Luz LED elegante montada en la pared para iluminación indirecta.

BRUXEL 12 DE PARED

230 V LED 6 W 3000 K 650 lm Ra 80

R13842 blanco

€ 88 **NEW**

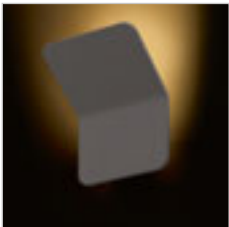
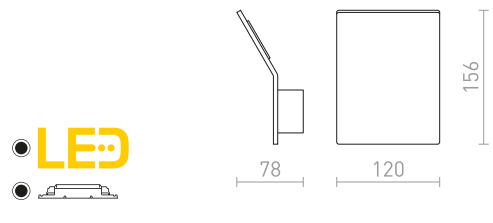

ATLANTA

Luminaria LED circular de pared para iluminación indirecta mediante la reflexión de la luz sobre la pared. Adecuada para uso en interiores y exteriores.

ATLANTA 13 MONTADAS EN SUPERFICIE

230 V LED 6 W 3000 K 780 lm Ra 80 IP54

R12825 blanco

€ 78

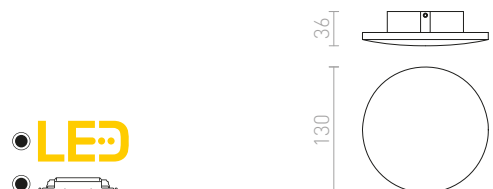



VIENNA

Luminaria LED cuadrada de pared con esquinas redondeadas para una reflexión indirecta desde la pared.

VIENNA MONTADAS EN SUPERFICIE

230 V LED 9 W 3000 K 1300 lm Ra 80

R12589 blanco

€ 88 %

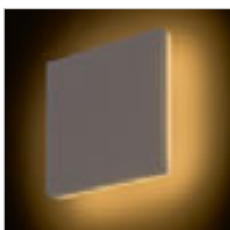
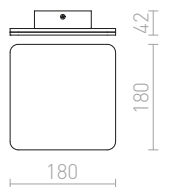
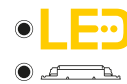

IP54

ATHI

Luminaria LED cuadrada de pared para iluminación indirecta mediante la reflexión de la luz sobre la pared. Adecuada para uso en interiores y exteriores.

ATHI DE PARED

230 V LED 9,6 W 3000 K 550 lm Ra 80 IP54

R12551 blanco

€ 120

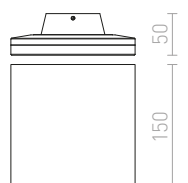



IP65



IP65

TITO

Lámpara LED de pared para iluminación ARRIBA/ ABAJO, con dos hojas metálicas para regular el haz de luz. Regulable TRIAC.

TITO R DIMM MONTADO EN LA PARED

230 V LED 2x3 W 3000 K 500 lm Ra 80 IP65

R13736 blanco

€ 88

R13737 negro

€ 88

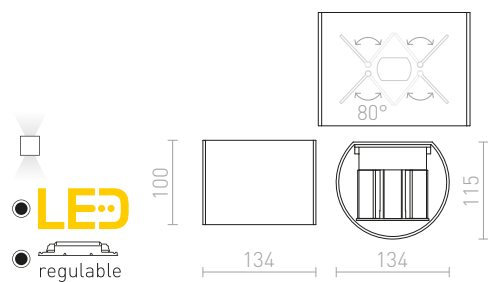

LED



regulable

TITO SQ DIMM MONTADO EN LA PARED

230 V LED 2x3 W 3000 K 500 lm Ra 80 IP65

R13738 blanco

€ 88

R13739 negro

€ 88

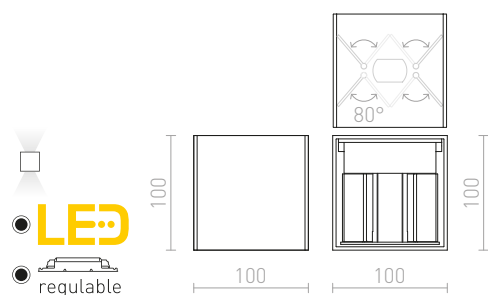

LED



regulable



IP54

CARRE

Luminaria de pared angular LED para iluminación ARRIBA/ABAJO, con dos hojas metálicas para regular el haz de luz.

CARRE DE PARED

230 V LED 2x3 W 3000 K 200 lm Ra 80 IP54

R12556 blanco

€ 88

R12557 gris antracita

€ 88

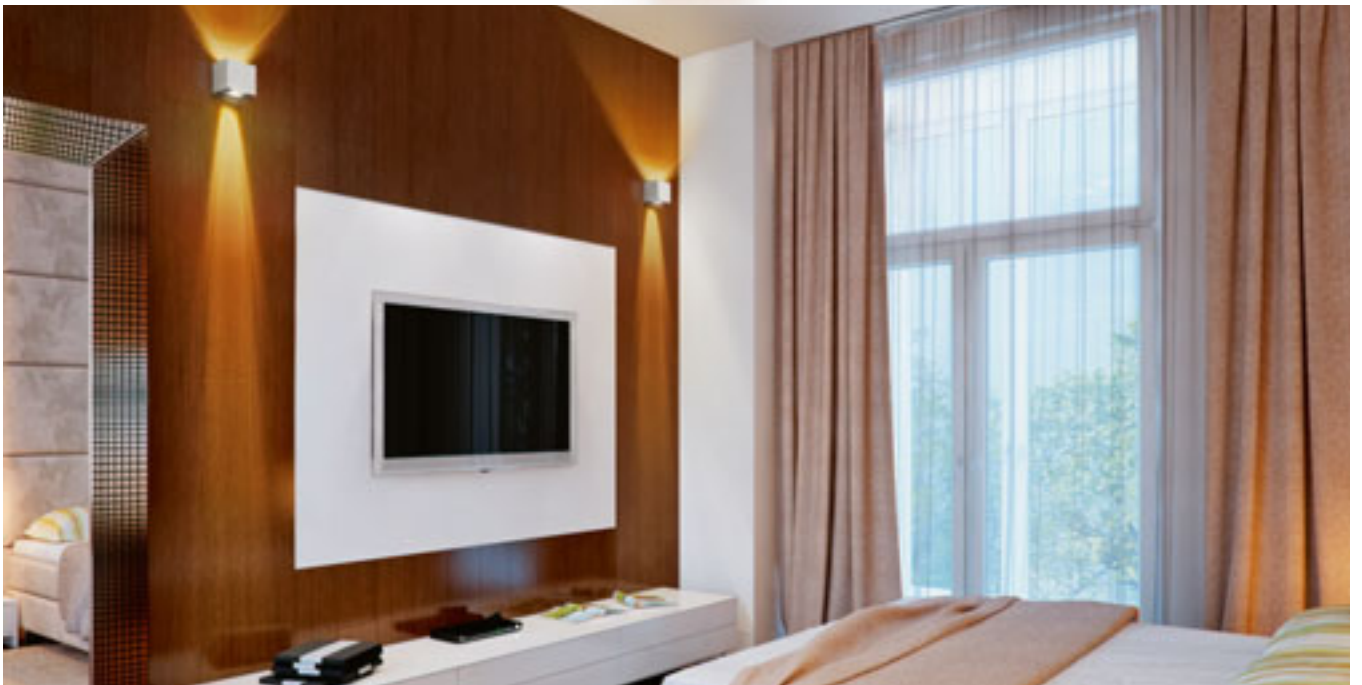
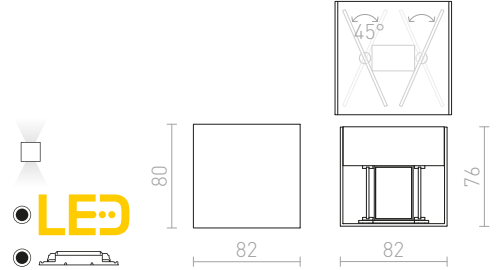

IP54

TITO

Lámpara LED de pared para iluminación ARRIBA/ABAJO, con dos hojas metálicas para regular el haz de luz.

TITO SQ DE PARED

230 V LED 6 W 3000 K 500 lm Ra 80 IP54

R12601 aluminio cepillado

€ 78

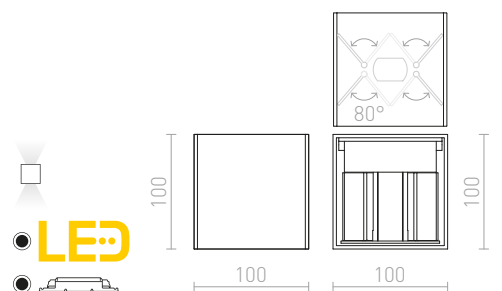



DAFFY

Luz redonda de LED para iluminación ARRIBA/ABAJO.

DAFFY DE PARED

230 V LED 6 W 3000 K 780 lm Ra 80

R12592 blanco

€ 98

R12593 negro

€ 98



110



IP54



MIDZACK

Lámpara redonda LED para iluminación ARRIBA/ ABAJO.

MIDZACK DE PARED

230 V LED 2x3 W 3000 K 480 lm Ra 80 IP54

R12585 blanco

€ 88

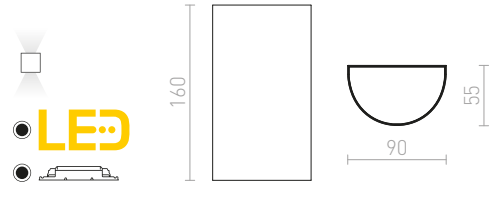

BIARITZ

Luminaria circular LED de pared para iluminación ARRIBA/ABAJO.

BIARITZ DE PARED

230 V LED 5 W 3000 K 780 lm Ra 80

R12606 blanco

€ 68

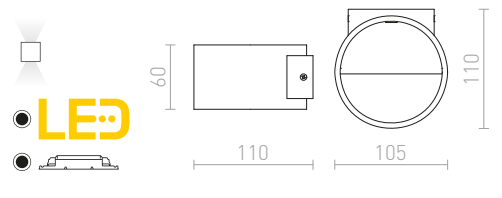

TUBA

Aplicador cilíndrico de metal con casquillo G9 e iluminación ARRIBA/ABAJO.

TUBA W DE PARED

230 V G9 33 W

R12739 blanco mate

€ 48

R12740 negro mate/oro

€ 48

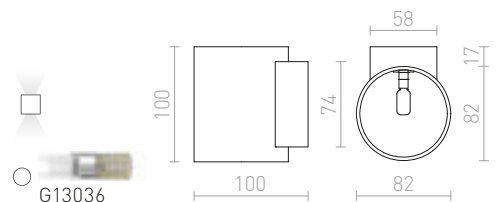



IP54

MICO

Aplique de aluminio fundido a presión con reflector fijo para iluminación unidireccional.

MICO I DE PARED
230 V GU10 35 W IP54

R10170 aluminio

€ 58

%



G11837

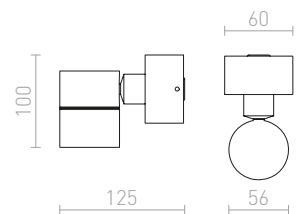



MICO

Mini ARRIBA/ABAJO hecha de aluminio pulido para bombillas halógenas.

MICO II DE PARED

230 V G9 2x25 W

R10129 aluminio

€ 68 %

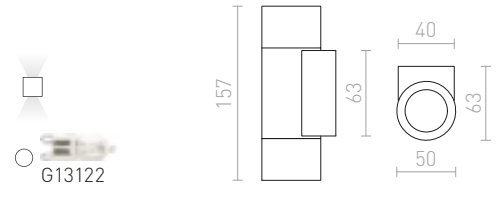

IP54

MOIRE

Lámpara de pared hecha de aluminio natural con cubiertas de vidrio.

MOIRE I DE PARED

230 V GU10 35 W IP54

R10133 aluminio

€ 48 %

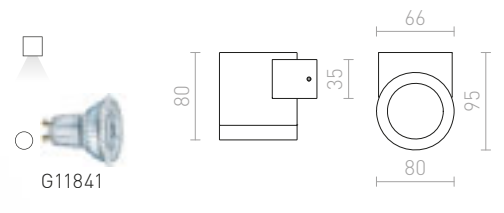

IP54

MOIRE II DE PARED

230 V G9 25 W IP54

R10132 aluminio

€ 68 %

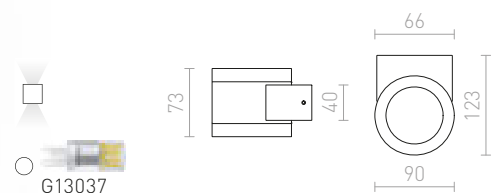

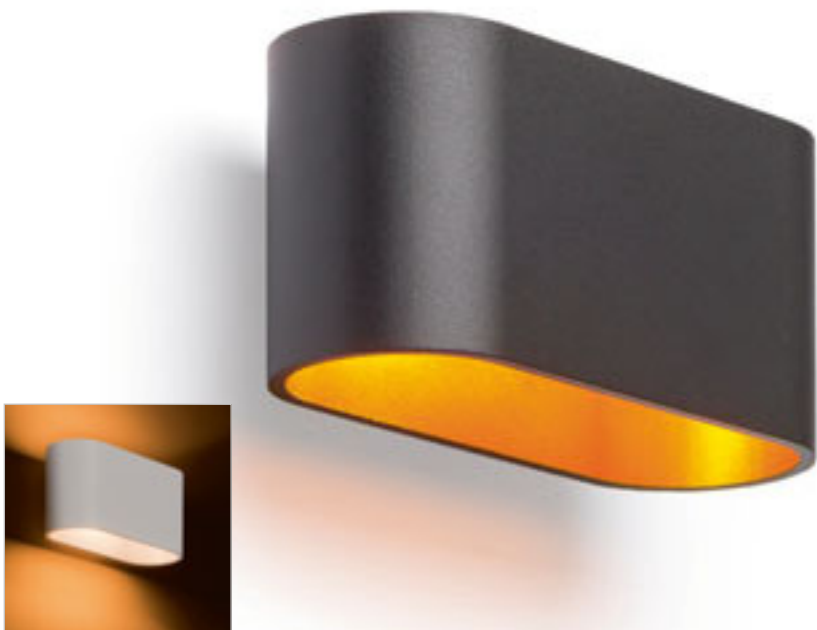

MARIO

Lámpara de pared, ovalada, hecha de metal, proporciona iluminación ARRIBA/ABAJO. Contiene un casquillo G9.

MARIO

230 V G9 33 W

R12743 blanco mate

€ 58

R12744 negro mate/oro

€ 68

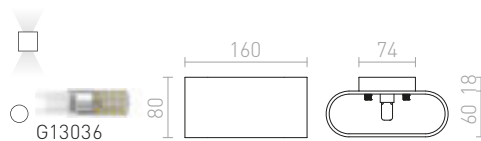

ROZA

Luminaria de pared LED, curvada. Proporciona iluminación ARRIBA/ABAJO.

ROZA DE PARED

230 V LED 6 W 3000 K 315 lm Ra80

R12575 blanco

€ 58

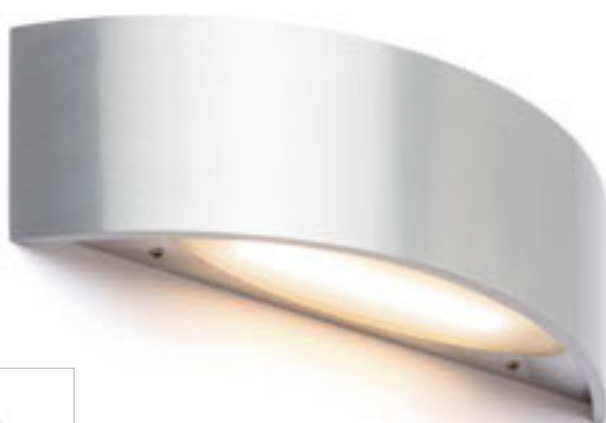
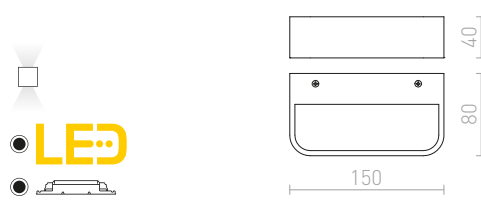

NAXOS

Luz redonda de LED para iluminación ARRIBA/ABAJO.

NAXOS DE PARED

230 V LED 6 W 3000 K 780 lm Ra80

R12590 blanco

€ 120 %

R12591 metal cepillado

€ 120 %

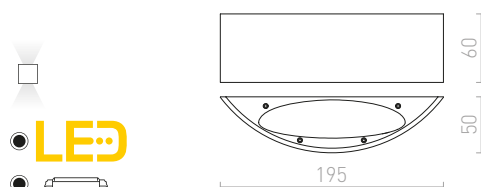
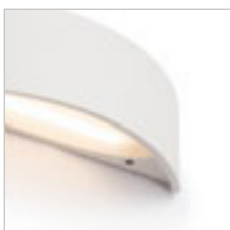



TAPA

Lámpara de pared LED rectangular para exteriores, con iluminación ARRIBA/ABAJO y fabricada en metal laqueado.

TAPA DE PARED

230 V LED 6 W 3000 K 277 lm Ra 80 [IP54](#)

R13562 blanco

€ 68

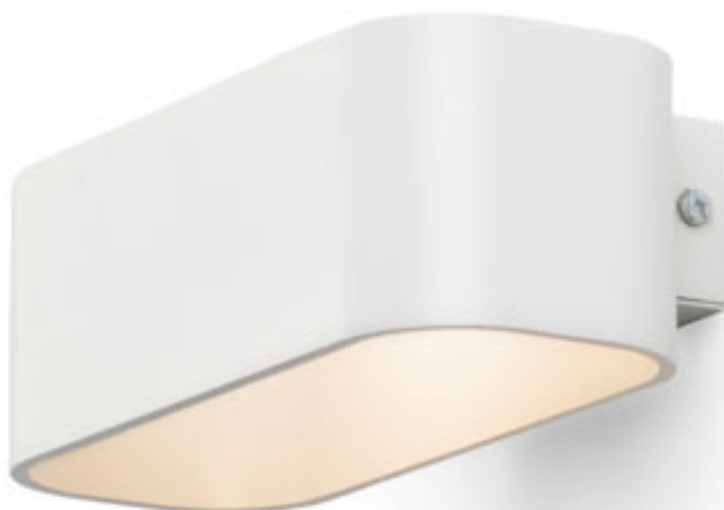
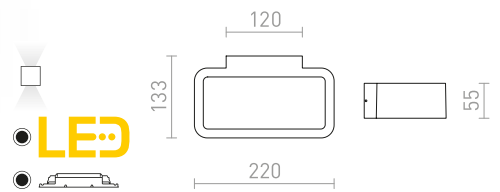

REEM

Luminaria de pared LED, colocada sobre un soporte de aluminio pintado. Proporciona iluminación ARRIBA/ABAJO.

REEM DE PARED

230 V LED 4,5 W 3000 K 300 lm Ra 80

R10401 blanco

€ 98

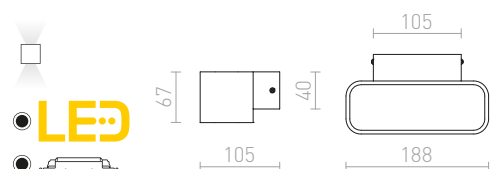



TRIP

Lámpara de metal rectangular de pared con luz ARRIBA/ABAJO con casquillo G9.

TRIP SQ DE PARED

230 V G9 33 W

R12741 blanco mate

€ 38

R12742 negro mate/oro

€ 48

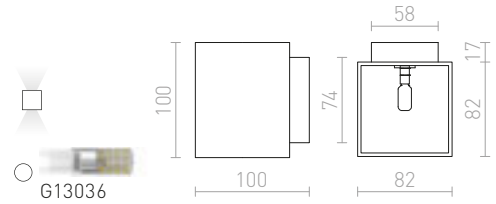

DIDO

Luminaria rectangular, de aluminio, color blanco. Tiene incorporado un potente LED para una iluminación ARRIBA/ABAJO.

DIDO DE PARED

230 V/500 mA LED 4,5 W 3000 K 250 lm Ra 80

R10400 blanco

€ 98

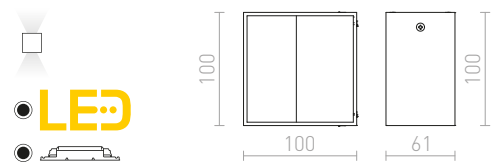

ESSEX

Lámpara de pared, rectangular, hecha de metal para iluminación ARRIBA/ABAJO, con casquillo G9.

ESSEX DE PARED

230 V G9 33 W

R12679 blanco mate

€ 35

R12680 aluminio cepillado

€ 35

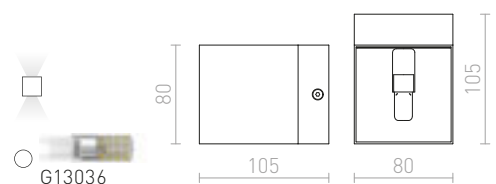



KORSO

Luminaria LED de pared. Adecuada para el uso en interiores y exteriores. Hecha de aluminio anodizado natural o negro.

KORSO II DE PARED

230 V LED 2x3 W $\angle 120^\circ$ 3000 K 780 lm Ra 80 IP54

R12831 aluminio cepillado

€ 68 %

R12832 anodizado preto

€ 68 %

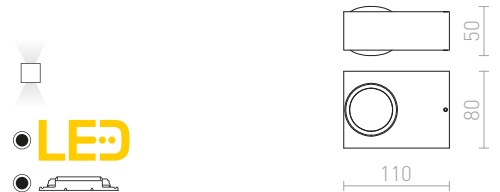

PEKKO

Luminaria de pared LED rectangular para iluminación unidireccional.

PEKKO DE PARED

230 V LED 3 W $\angle 67^\circ$ 3000 K 86 lm Ra 80 IP54

R12552 blanco

€ 78

R12553 negro

€ 78

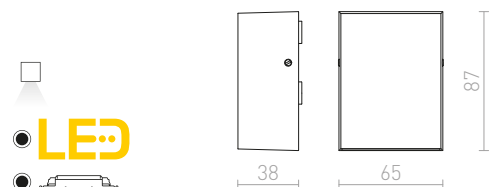

ONYX

Luminaria de pared LED cúbica con esquinas redondeadas y una superficie de reflexión texturizada para iluminación ARRIBA/ABAJO.

ONYX DE PARED

230 V LED 5 W 3000 K 500 lm Ra 80

R12598 blanco

€ 68

R12599 negro

€ 68

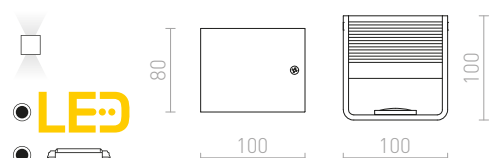

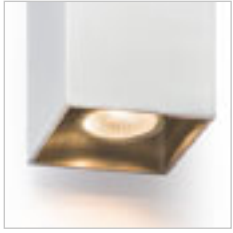

AGATE

Aplique de pared rectangular de metal con iluminación ARRIBA/ABAJO. Se usan dos fuentes de luz GU10.

AGATE II DE PARED

230 V GU10 2x35 W

R12677 blanco mate

€ 68

R12678 aluminio cepillado

€ 48

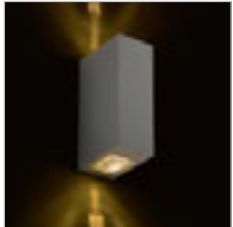
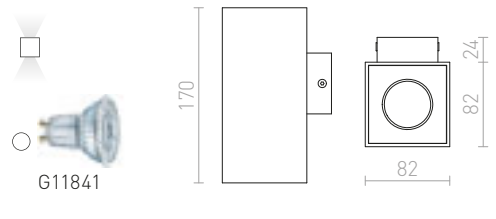

IP54

NICK

Lámpara de pared LED con iluminación ARRIBA/ABAJO, adecuada para el uso en interiores y exteriores.

NICK II DE PARED

230 V LED 2x3 W $\angle 10^\circ$ 3000 K 780 lm Ra 80 IP54

R12827 aluminio cepillado

€ 68

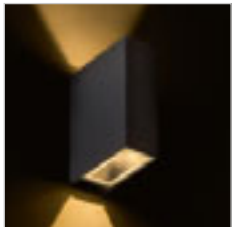
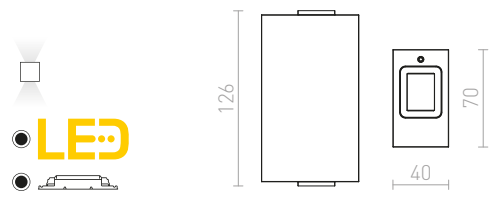

IP54

UKKO

Luminaria de pared LED empotrable para exteriores con iluminación ARRIBA/ABAJO.

UKKO DE PARED

230 V LED 2x3 W $\angle 55^\circ$ 3000 K 180 lm Ra 80 IP54

R12555 negro

€ 120

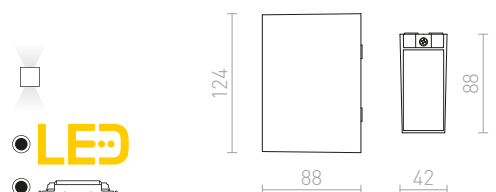



IP44

DESMOND

Aplique de pared para exterior de aluminio con iluminación ARRIBA/ABAJO para dos bombillas LED con casquillo GU10.

DESMOND II MURO

230 V GU10 2x35 W IP44

R13609 blanco

€ 68

R13610 gris plata

€ 68

R13611 gris antracita

€ 68



G11841

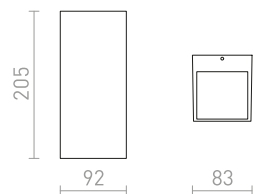

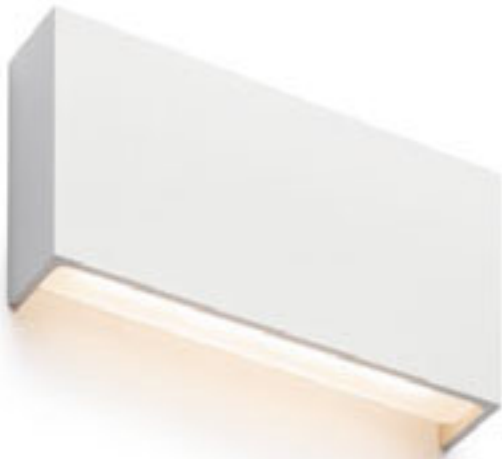

IP54

TORINO

Luminaria de pared LED rectangular, con iluminación ARRIBA/ABAJO.

TORINO DE PARED

230 V LED 2x5 W 3000 K 550 lm Ra 80 IP54

R12573 blanco

€ 129

R12574 negro

€ 129



LED

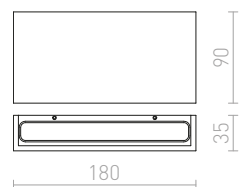



LEA

Luminaria de pared LED, rectangular. Proporciona iluminación ARRIBA/ABAJO.

LEA DE PARED

230 V LED 6 W 3000 K 650 lm Ra 80

R12587 blanco

€ 68 %

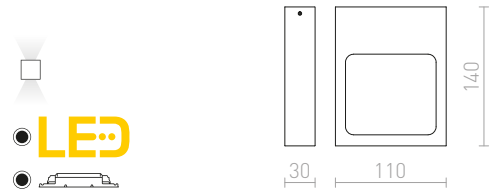

NEMAN

Luminaria de pared LED, rectangular. Proporciona iluminación ARRIBA/ABAJO.

NEMAN DE PARED

230 V LED 10 W 3000 K 1300 lm Ra 80

R12595 negro

€ 120

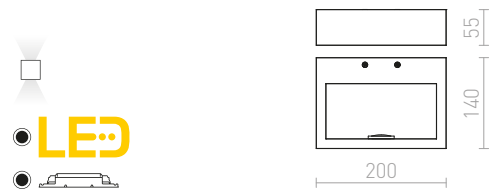

CHLOE

Lámpara de pared LED, rectangular, hecha de acero inoxidable. Proporciona iluminación indirecta. Es adecuada para exteriores e interiores.

CHLOE DE PARED

230 V LED 9 W 3000 K 800 lm Ra 80 IP65

R11752 acero inoxidable

€ 120

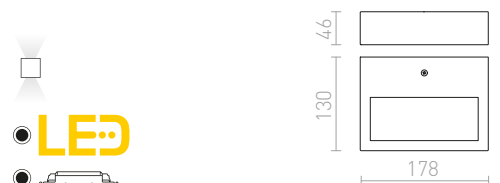

IP65

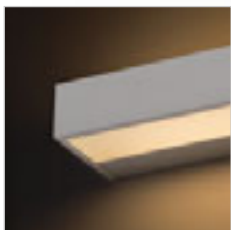

PRIO LED

Lámpara LED de pared, hecha de aluminio, brinda una iluminación ARRIBA/ABAJO. La luminaria es ofrecida en un acabado de dos colores. ¡La luminaria no debe ser usada como un estante!

PRIO LED 62 DE PARED

230 V LED 33 W 3000 K 720 lm Ra 80

R12091 blanco

€ 178

%

R12092 aluminio cepillado

€ 178

%



LED

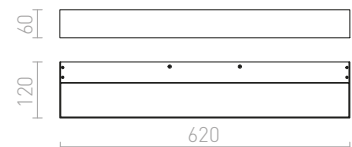



TWIST

Luminaria de pared LED de aluminio, para exterior con posibilidad de regular la iluminación hacia abajo o como iluminación indirecta hacia arriba.

TWIST MURO

230 V LED 12 W 3000 K 980 lm Ra 80 IP65

R13615 blanco

€ 98

R13616 gris antracita

€ 98

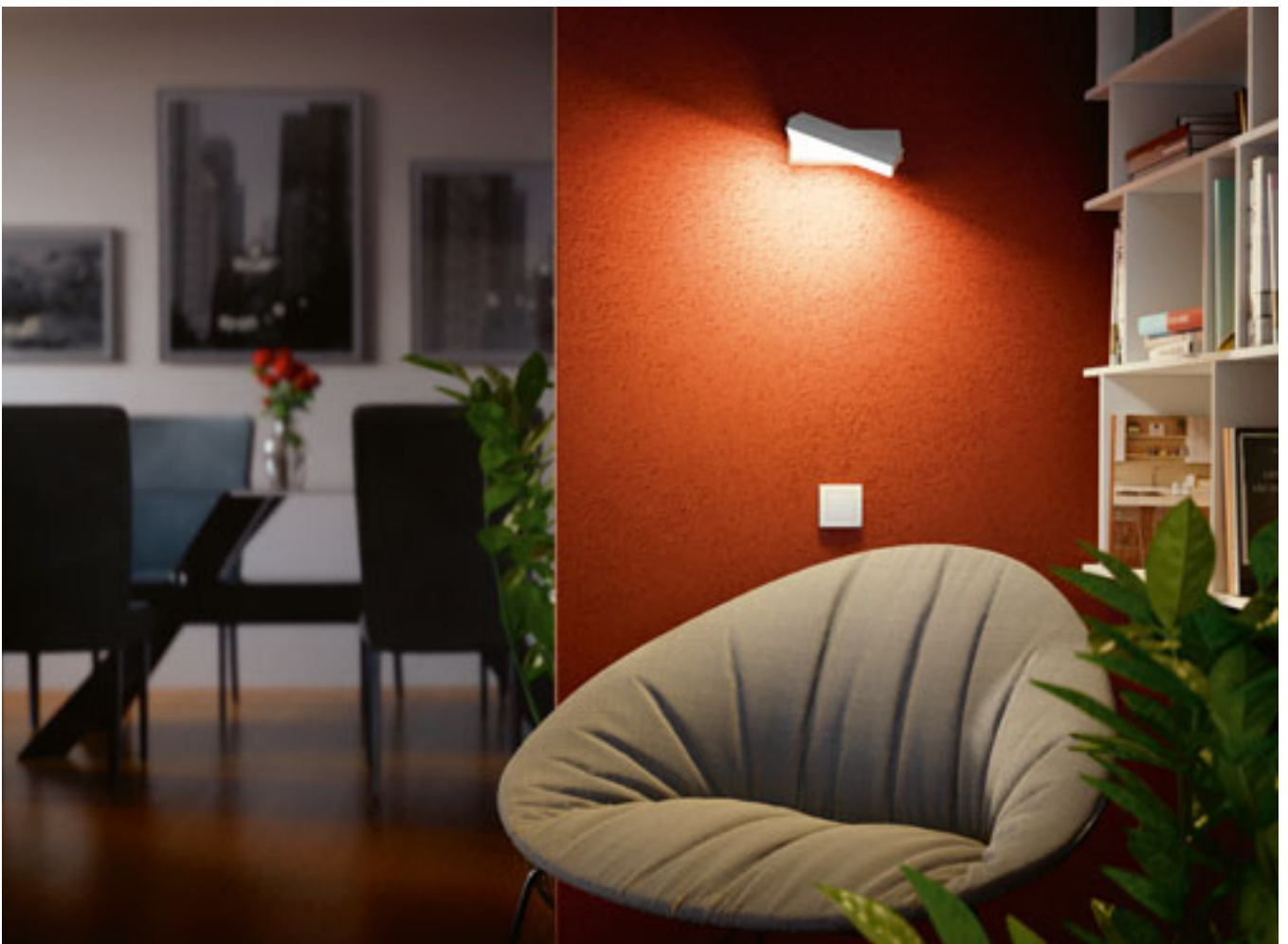
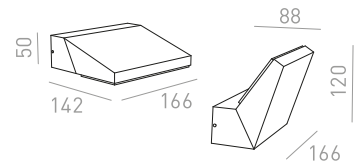
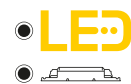



SWING

Luz lineal con LED integrado, adecuado para uso sobre cuadros.

SWING SOBRE CUADRO

230 V LED 8 W 3000 K 750 lm Ra 80

R12954 cromo

€ 138

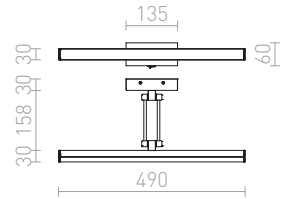
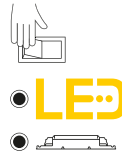

IP44

SWAY

Aplique LED lineal inclinable, adecuado para uso sobre cuadros y espejos.

SWAY BAÑO

230 V LED 12 W 3000 K 1060 lm Ra 80 IP44

R12951 cromo

€ 120

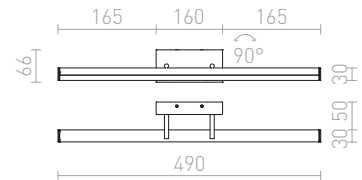

IP44

PANON

Aplique LED lineal en brazo macizo con iluminación descendente. Adecuado para uso en ambientes húmedos.

PANON LONG DE PARED

230 V LED 12 W 3000 K 900 lm Ra 80 IP44

R12950 cromo

€ 120

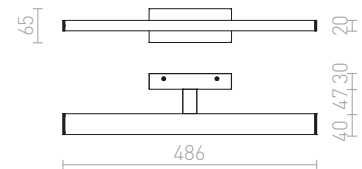
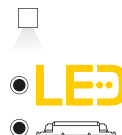



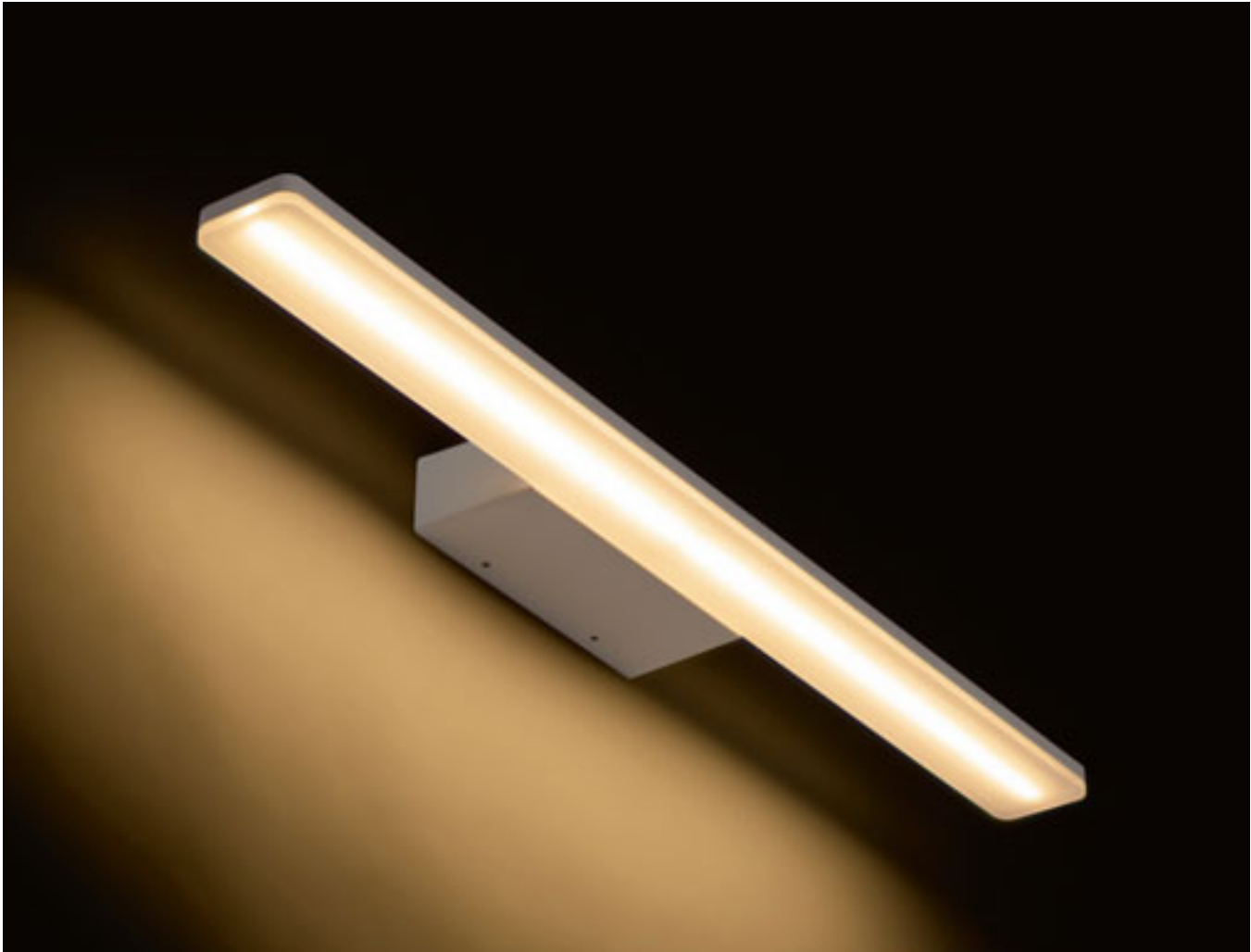

IP44



MAREA

Luminaria LED lineal con iluminación descendente, apta para uso sobre el espejo. Para uso en ambientes húmedos.

MAREA 60 DE PARED

230 V LED 18 W 3000 K 1954 lm Ra 80 IP44

R13554 blanco

€ 188

R13852 negro

€ 188

NEW

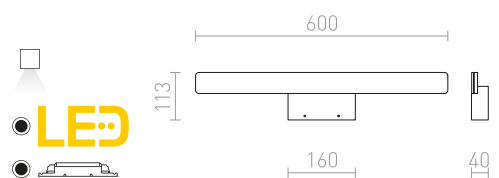



IP44

IMPERISO

Luminaria LED lineal adecuado para uso sobre espejos. La parte frontal de la luminaria se puede girar en el eje horizontal. Para uso en ambientes húmedos.

IMPERISO 60

230 V LED 18 W 3000 K 1769 lm Ra 80 IP44

R13555 blanco

€ 248

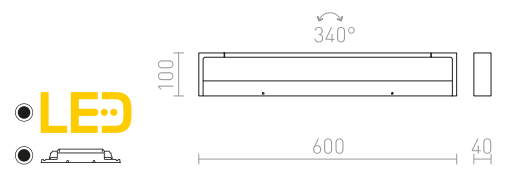

IP54

LUISA

Luminaria LED lineal con iluminación descendente, adecuado para uso sobre el espejo. Para uso en ambientes húmedos.

LUISA 60 DE PARED

230 V LED 12 W 3000 K 1138 lm Ra 80 IP54

R13735 blanco

€ 150

R13853 negro

€ 150

NEW

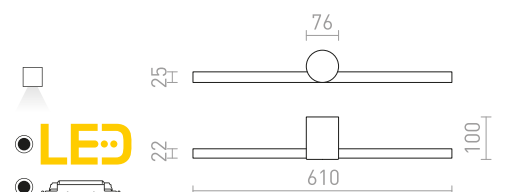



IP44



IP44



FLORIO

Luminaria para baño con LED integrado y una toma de bajo consumo de energía de hasta 100W.

FLORIO 49

230 V LED 8W 3000 K 640 lm Ra 80 IP44

R12903 blanco

€ 88

R12904 cromo

€ 98



LED

55



480

65



IP44



IP44



CORAZON

Luminaria lineal con LED integrado adecuada para ambientes húmedos.

CORAZON 60

230 V LED 15W 3000 K 1200 lm Ra 80 IP44

R12901 cromo

€ 78



LED

51



600

70

CORAZON 90

230 V LED 20W 3000 K 1600 lm Ra 80 IP44

R12902 cromo

€ 120



LED

51



900

70





TICO

Luminaria de pared con iluminación unidireccional, hecha de aluminio macizo.

TICO I DE PARED

230 V LED 3W 3000 K 190lm Ra 80

R10178 aluminio

€ 38 %

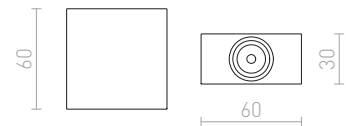
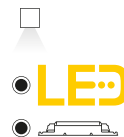



IP54

AMBER

Luminaria de pared LED circular, para iluminación de orientación sin necesidad de inserción.

AMBER DE PARED

230 V LED 3 W 3000 K 130 lm Ra 80

R12610 gris

€ 48 %

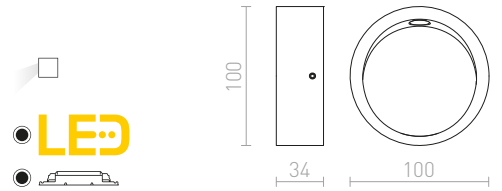

IP54

AQILA

Luminaria LED de pared para la iluminación orientativa en pavimentos, escaleras o terrazas. Adecuada para el uso en interiores y exteriores sin la necesidad de ser empotrada.

AQILA SQ DE PARED

230 V LED 6 W 3000 K 200 lm Ra 80 IP54

R12542 blanco

€ 88

R12544 gris antracita

€ 88

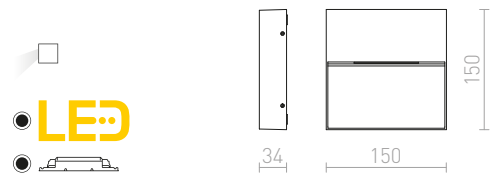

AQILA RC DE PARED

230 V LED 6 W 3000 K 200 lm Ra 80 IP54

R12545 blanco

€ 88 →

R12547 gris antracita

€ 98

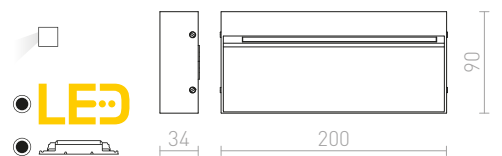

IP54

AQILA R DE PARED

230 V LED 6 W 3000 K 200 lm Ra 80 IP54

R12539 blanco

€ 88

R12540 gris

€ 78 →

R12541 gris antracita

€ 88

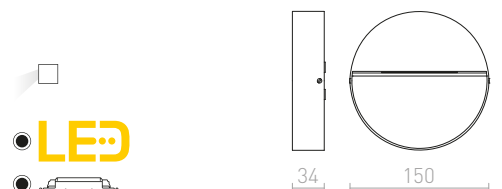

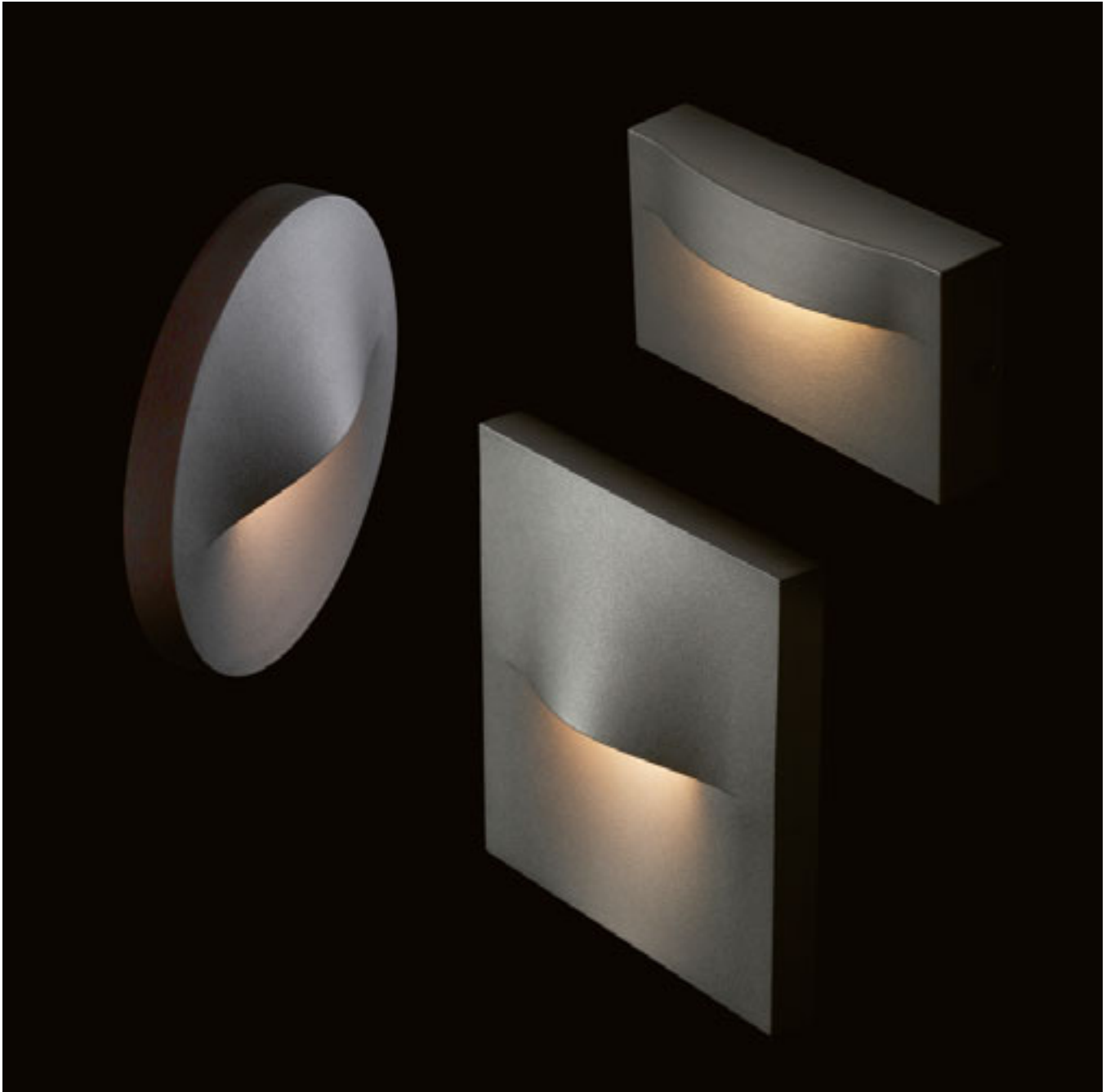

IP65



BOBO

Lámpara de superficie de aluminio con LED incorporado, apta para la iluminación de caminos y escalones. Para uso en exteriores. No necesita ser empotrada.

BOBO R DE PARED

230 V LED 3 W 3000 K 212 lm Ra80 IP65

R13933 gris antracita

€ 48

NEW

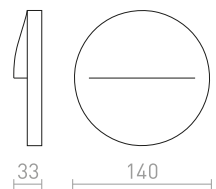
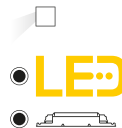



IP65

BOBO

Lámpara de superficie de aluminio con LED incorporado, apta para la iluminación de caminos y escalones. Para uso en exteriores. No necesita ser empotrada.

BOBO RC DE PARED

230V LED 8W 3000K 640lm Ra80 IP65

R13934 gris antracita

€ 58 **NEW**

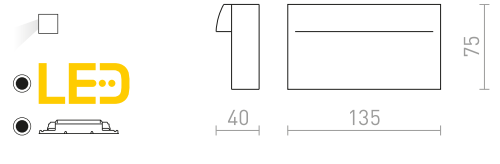

IP65

BOBO

Lámpara de superficie de aluminio con LED incorporado, apta para la iluminación de caminos y escalones. Para uso en exteriores. No necesita ser empotrada.

BOBO SQ DE PARED

230V LED 3W 3000K 135lm Ra80 IP65

R13935 gris antracita

€ 48 **NEW**

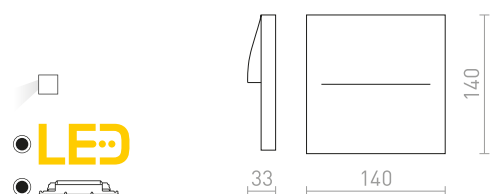

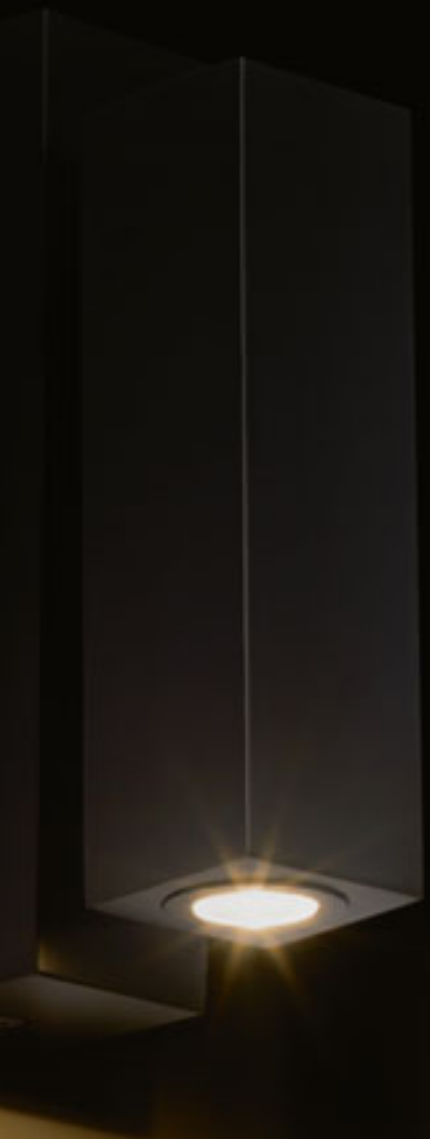

FOCOS

DE BAÑO	272-275
PARA CABECEROS DE CAMA	276-285
CONJUNTOS	286-303
CUELLO DE GANSO	304-309
INCLINABLES	310-317

FOCOS DE BAÑO



LINN I
272-273



LINN III
272-273



VALTO I
272-273

272-275



VALTO III
272-273



BOLLY III
272-273



DUBLIN I
274-275



DUBLIN II
274-275



DUBLIN III
274-275



DUBLIN IV
274-275

FOCOS PARA CABECEROS DE CAMA



VERSA
276-277



VERSINA
276-277



TAINA
276-277

276-285



PERTH
276-277



CHOUETTE
278-279



ARAQ
278-279



HAREN
278-279



ROSTAM
278-279



VIPER WL
280-281



TIARA
280-281



FADO I
280-281



MIG
280-281



TAPIO I SQ
280-281



AMADEUS I
282-283



STIG
282-283



THALIA
282-283



VOLTERA USB
284-285



SIENA
284-285



ELISEO
284-285

FOCOS CONJUNTOS



BOGARD I
286-287



BOGARD II
286-287



BOGARD III
286-287

286-303



KENNY I
288-289



KENNY II
288-289



KENNY III
288-289



KENNY IV
288-289



KENNY
288-289



DUDE R
290-291



DUDE SQ
290-291



DUDE
290-291



DUDE II
290-291



DUGME I
292-293



DUGME II
292-293



DUGME III
292-293



TRICA I
294-295



TRICA II
294-295



TRICA III
294-295



KELLY LED I
296-297



KELLY LED II
296-297



KELLY LED III
296-297



KELLY LED
296-297



KELLY LED I
298-299



KELLY LED II
298-299



KELLY LED III
298-299



ELISEO
300-301



ELISEO II
300-301



GLOSSY
302-303



GLOSSY I
302-303



GLOSSY III
302-303



ROSITA I
302-303



ROSITA II
302-303

FOCOS CUELLO DE GANSO

304-309



AIM
304-305



FRISCO W
304-305



EKE
304-305



POINT
306-307



VERSA
306-307



SHOW
306-307



BOB
306-307



KAYA
308-309



FLAP
308-309



VALE
308-309

FOCOS INCLINABLES



CELEIA
310-311



AGNETA
310-311



BAROQUE
310-311

310-317



JOLI I
310-311



BELENOS
312-313



BOGARD
312-313



BOGARD TWIN
312-313



OPTIMUS
312-313



DARIO
314-315



DARIO
314-315



PIXIE
314-315



ORIT
314-315



CASSIE
316-317



BUGSY I
316-317



REDO
316-317



MARVEL II
316-317



IP44

BOLLY

Luminaria de pared o techo con cristal opalino sobre base cromada. Adecuada para ambientes húmedos.

BOLLY III MONTADAS EN SUPERFICIE

230 V G9 LED 3x3 W IP44

R13691 vidrio opal/cromo

€ 129

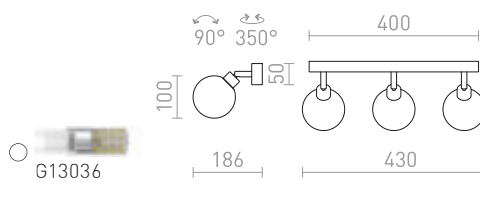

IP44

LINN

Luminarias de pared o techo con cristal opalino sobre base cromada. Apto para ambientes húmedos.

LINN I DE PARED

230 V G9 LED 3 W IP44

R13695 vidrio opal/cromo

€ 48

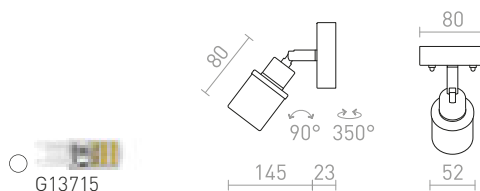

LINN III MONTADAS EN SUPERFICIE

230 V G9 LED 3x3 W IP44

R13703 vidrio opal/cromo

€ 120

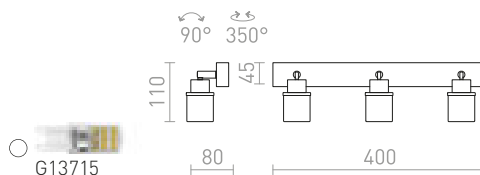



IP44

VALTO

Luminarias de pared o techo con reflector basculante para bombillas LED con casquillo GU10. Apto para ambientes húmedos.

VALTO I DE PARED

230 V GU10 LED 5 W IP44

R13696 cromo

€ 48



G11837

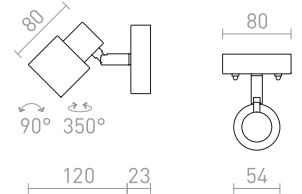

VALTO III MONTADAS EN SUPERFICIE

230 V GU10 LED 3x5 W IP44

R13704 cromo

€ 88



G11837

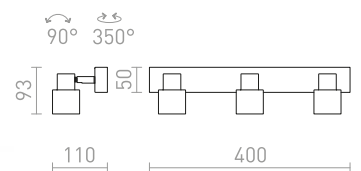





IP44



IP44



IP44



IP44

DUBLIN

Foco cromado adecuado para zonas húmedas.

DUBLIN I MONTADO EN SUPERFICIE

230 V GU10 9 W IP44

R13377 cromo

€ 48

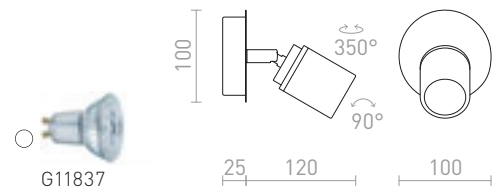

DUBLIN II MONTADO EN SUPERFICIE

230 V GU10 2x9 W IP44

R13378 cromo

€ 78

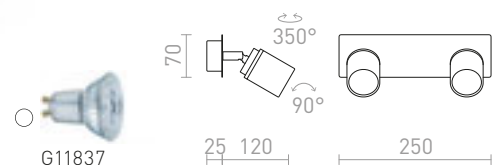

DUBLIN III MONTADO EN SUPERFICIE

230 V GU10 3x9 W IP44

R13379 cromo

€ 98

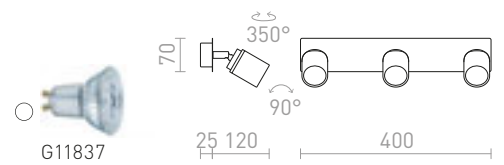

DUBLIN IV MONTADO EN SUPERFICIE

230 V GU10 4x9 W IP44

R13380 cromo

€ 129

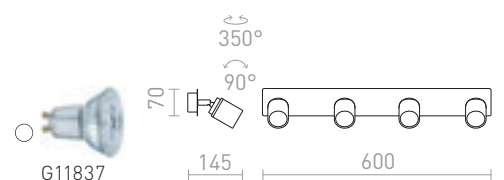

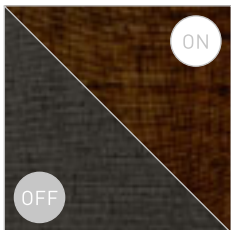
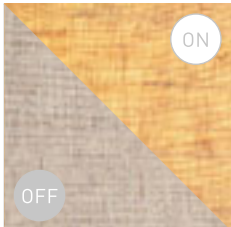

PERTH

Aplique de pared con pantalla textil cuadrada, con brazo flexible con reflector LED. La luminaria tiene dos fuentes de luz que se pueden controlar por separado mediante un interruptor giratorio ubicado en la base cuadrada de la luminaria.

PERTH PARED CON FOCO LED

230 V E14 LED 15 W+3 W $\angle 30^\circ$ 3000 K 150 lm Ra 80

R13661 beige/blanco/cromo

€ 178

R13662 negro/negro/cromo

€ 178



G13572

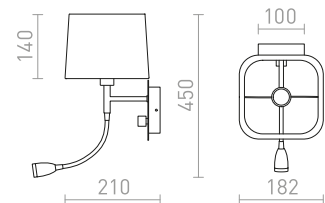



VERSA

Lámpara de pared con pantalla textil que lleva un brazo flexible adicional, el cual tiene un reflector LED. La luminaria tiene dos fuentes de luz que pueden ser reguladas por separado mediante un interruptor de palanca situada en su base circular.

VERSA DE PARED CON PANTALLA

230 V E27 LED 42 W+3 W $\angle 40^\circ$ 3000 K 240 lm Ra 80

R10580 blanco/níquel mate

€ 178

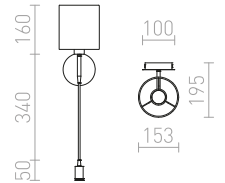

VERSINA

Lámpara de pared con pantalla textil, con un brazo flexible que tiene un reflector LED. La luminaria tiene dos fuentes de luz que se pueden regular por separado mediante interruptores ubicados en su base de forma circular.

VERSINA CON PANTALLA

230 V E27 LED 28 W+3 W $\angle 25^\circ$ 3000 K 180 lm Ra 80

R12955 blanco/cromo

€ 129

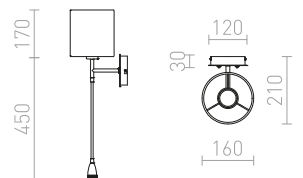

TAINA

Lámpara de pared con pantalla textil, con un brazo flexible que lleva un reflector LED. Las dos fuentes de luz pueden ser reguladas por separado, mediante interruptores que se encuentran en la base de la luminaria.

TAINA CON PANTALLA

230 V E27 LED 28 W+3 W $\angle 25^\circ$ 3000 K 180 lm Ra 80

R12956 blanco/níquel mate

€ 138

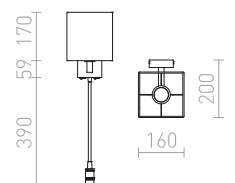



CHOUPETTE

Lámpara textil de pared con posibilidad de deslizar sobre una consola de madera. El cable de alimentación termina con un enchufe a toma.

CHOUPETTE DE PARED AJUSTABLE

230 V E27 15 W

R13649 gris negruzco/textil/madera

€ 215

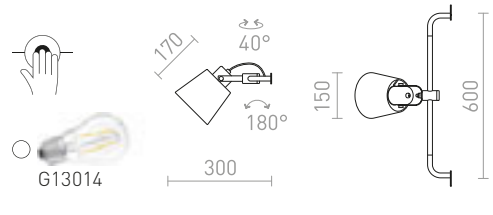

ROSTAM

Luminaria LED de pared con repisa para guardar el teléfono y puerto USB integrado. El foco LED situado en el cuello flexible y la iluminación indirecta se controlan por separado mediante dos interruptores.

ROSTAM PARED CON USB

230 V LED 2x3W 3000 K 350 lm Ra 80

R13571 negro

€ 150

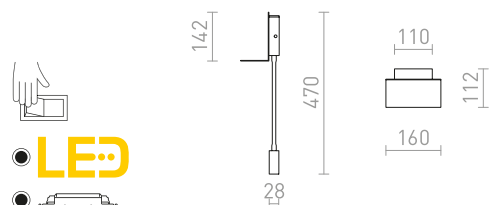



ARAQ

Lámpara de pared con casquillo y brazo de latón sobre base lacada en negro. Para ser utilizada con una fuente de luz E27 decorativa adecuada.

ARAQ DE PARED

230 V E27 42 W

R13890 latón cepillado/negro

€ 32

NEW

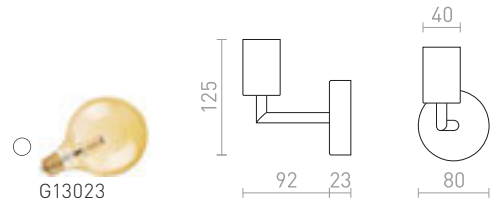

HAREN

Reflector masivo equipado con casquillo E27 para uso con foco de luz.

HAREN MONTADO EN SUPERFICIE

230 V E27 15 W

R13612 cobre/negro

€ 58

R13613 negro

€ 48

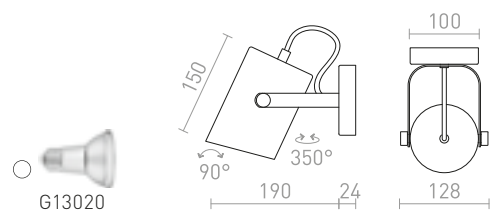



VIPER

Lámpara de pared cromada de diseño con reflector LED negro y cable textil rojo.

VIPER WL

230 V LED 3 W $\angle 60^\circ$ 3000 K 100 lm Ra 80

R12461 negro/cromo

€ 88 %

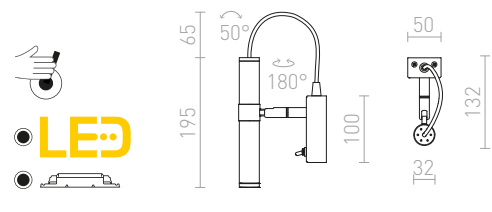

FADO

Lámpara de pared con diseño rectangular con un reflector LED regulable.

FADO I DE PARED

230 V LED 3 W $\angle 45^\circ$ 4000 K 110 lm Ra 80

R12473 negro

€ 129

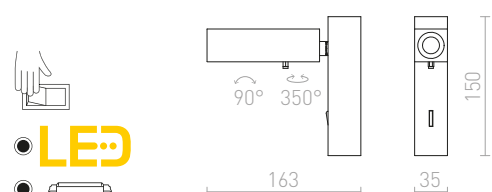

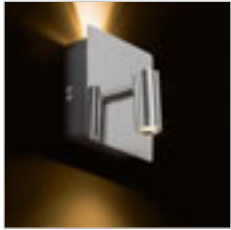

TIARA

Lámpara de pared con dos fuentes de luz LED integradas, las cuales pueden ser reguladas por separado mediante interruptores situados en la base de la luminaria.

TIARA DE PARED

230 V LED 2x3 W $\angle 25^\circ$ 3000 K 300 lm Ra 80

R12957 cromo

€ 68 %

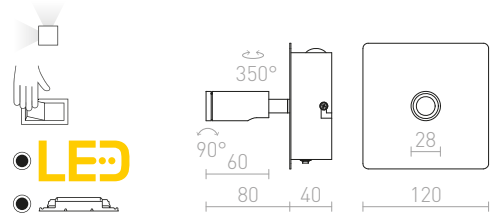

TAPIO

Lámpara de pared con LED incorporado en una base rectangular.

TAPIO I SQ APLIQUE DE PARED

230 V LED 4,5 W 3000 K 350 lm Ra 80

R13423 negro

€ 88

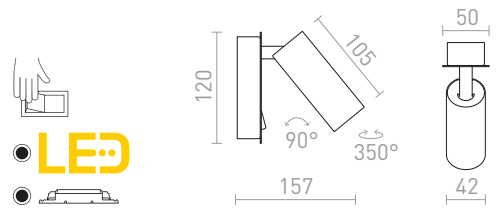

MIG

Elegante aplique LED con interruptor adecuado para uso en el dormitorio. El cable se puede enchufar a la toma mediante un ojal en la base. El cable no está incluido en el paquete.

MIG MURO

230 V LED 3 W $\angle 30^\circ$ 3000 K 150 lm Ra 80

R13644 blanco

€ 78

R13645 negro

€ 78

R13646 níquel mate

€ 68

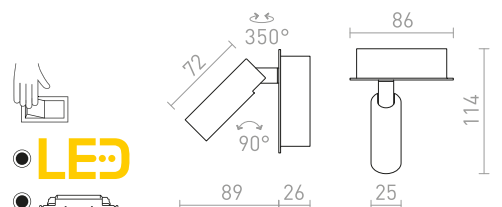



AMADEUS

Luminaria LED de pared con un interruptor en la base.
La pantalla es rotable.

AMADEUS I DE PARED

230 V LED 6 W 3000 K 530 lm Ra 80

R12476 blanco

€ 120

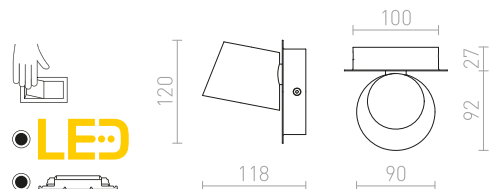



THALIA

Aplique LED con reflector complementado con iluminación indirecta. La luminaria tiene dos fuentes de luz que se pueden controlar por separado mediante interruptores ubicados en la base de la luminaria.

THALIA DE PARED

230 V LED 6 W + 3 W 3000 K 480 lm Ra 80

R13765 negro/acrílico satinado

€ 138 **NEW**



LED

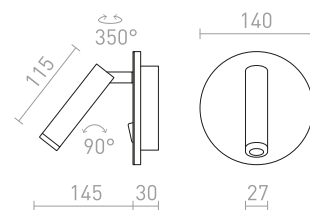

STIG

Elegante luz ED con interruptor de palanca.

STIG DE PARED

230 V LED 5,6 W $\angle 34^\circ$ 3000 K 404 lm Ra 80

R13941 negro

€ 98 **NEW**



LED

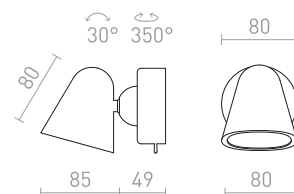
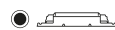



VOLTERA

Luminaria de pared laqueada con reflector basculante para fuentes de luz con casquillo GU10. La luminaria tiene un puerto USB integrado en la base, apto para cargar, por ejemplo, un teléfono.

VOLTERA USB DE PARED

230 V GU10 50 W

R13763 blanco

€ 129 **NEW**

R13764 negro

€ 129 **NEW**

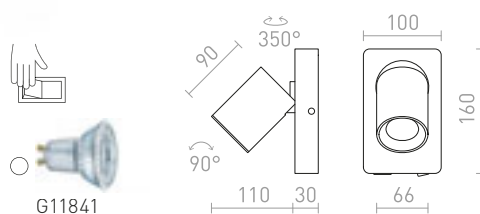

ELISEO

Lámpara de pared con cabezal giratorio en forma de platillo, LED incorporado y difusor en color ópalo.

ELISEO DE PARED

230 V LED 5 W 3000 K 320 lm Ra 80

R13914 blanco

€ 88 **NEW**

R13915 negro

€ 88 **NEW**

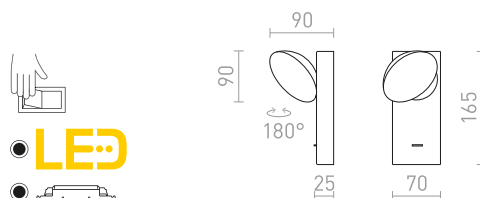



SIENA

Luminaria de pared laqueada con reflector basculante para fuentes de luz con casquillo GU10. El interruptor se encuentra en la base de la luminaria.

SIENA DE PARED

230 V GU10 50 W

R13761 blanco

€ 88 NEW

R13762 negro

€ 88 NEW

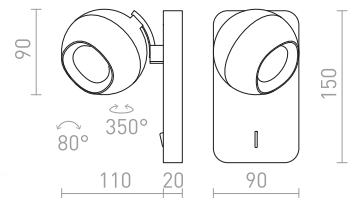
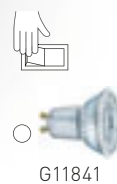



BOGARD

Foco direccional de pared con LED integrado.

BOGARD I DE PARED

230 V LED 5W $\angle 40^\circ$ 3000 K 496 lm Ra 80

R12502 níquel mate

€ 58 %

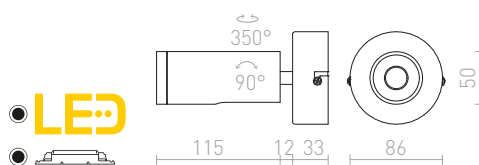

LED



BOGARD II DE PARED

230 V LED 2x5 W $\angle 40^\circ$ 3000 K 700 lm Ra 80

R12503 negro mate

€ 98 %

R12504 níquel mate

€ 48 %

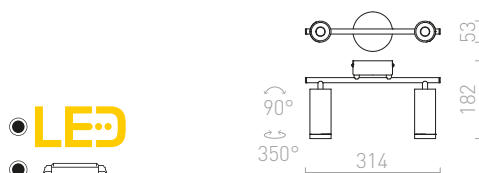

LED



BOGARD III DE PARED

230 V LED 3x5 W $\angle 40^\circ$ 3000 K 1050 lm Ra 80

R12505 negro mate

€ 120 %

R12506 níquel mate

€ 68 %

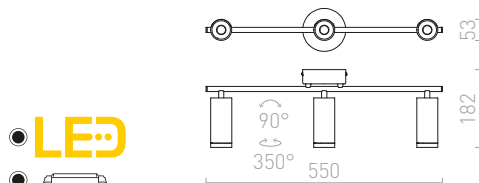

LED







KENNY

Elegante serie de puntos para fuentes de luz GU10, con la posibilidad de cambiar la apariencia con detalles de color intercambiables.

KENNY I MONTADAS EN SUPERFICIE

230 V GU10 35 W

R12912 blanco/negro € 58

R12913 aluminio cepillado/negro € 58

R12914 negro/oro € 58

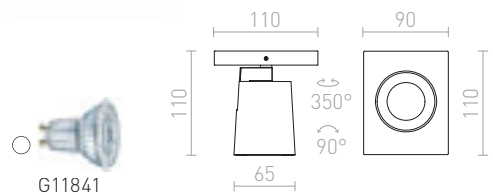

KENNY II MONTADAS EN SUPERFICIE

230 V GU10 2x35 W

R12915 blanco/negro € 120

R12916 aluminio cepillado/negro € 120

R12917 negro/oro € 120

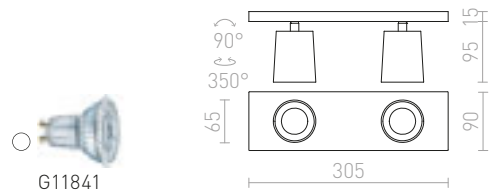

KENNY III MONTADAS EN SUPERFICIE

230 V GU10 3x35 W

R12918 blanco/negro € 158

R12919 aluminio cepillado/negro € 150

R12920 negro/oro € 158

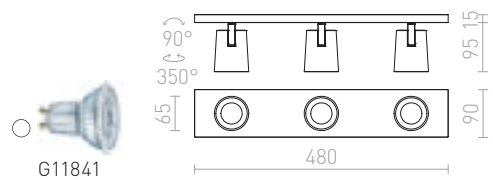

KENNY IV DE TECHO

230 V GU10 4x35 W

R12921 blanco/negro € 188

R12922 aluminio cepillado/negro € 178

R12923 negro/oro € 188

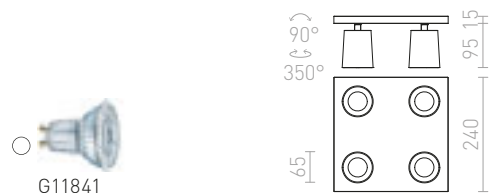



KENNY

Embellecedor opcional para la serie de focos KENNY para cambiar fácilmente el diseño de color.

KENNY ANILLO DECORATIVO

R12924 blanco	€ 3.60
R12925 oro	€ 3.60
R12926 negro	€ 3.60

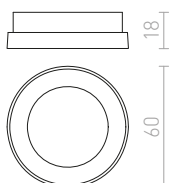



DUDE

Lámpara de superficie para fuentes de luz LED con casquillo GU10.

DUDE SQ PARED O TECHO

230 V LED GU10 9 W

R13920 blanco

€ 48 NEW

R13921 negro

€ 48 NEW

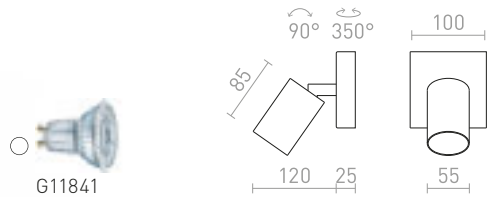

DUDE

Lámpara de superficie para fuentes de luz LED con casquillo GU10.

DUDE R PARED O TECHO

230 V LED GU10 9 W

R13918 blanco

€ 48 NEW

R13919 negro

€ 48 NEW

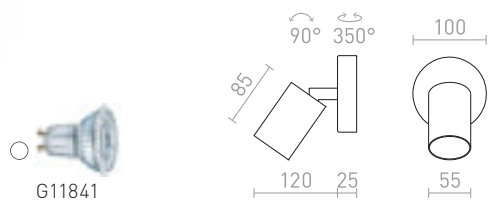

DUDE

Proyector de superficie para dos fuentes de luz LED GU10.

DUDE II PARED O TECHO

230 V LED GU10 2x9 W

R13922 blanco

€ 98 NEW

R13923 negro

€ 98 NEW

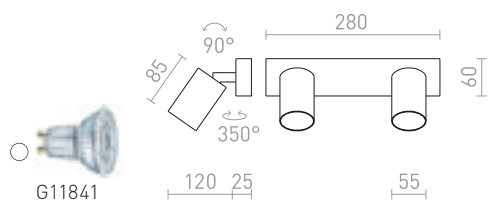



DUDE

Lámpara de pared con interruptor y casquillo GU10 para fuentes de luz LED.

DUDE DE PARED

230 V LED GU10 9 W

R13924 blanco

€ 58 NEW

R13925 negro

€ 58 NEW



G11841

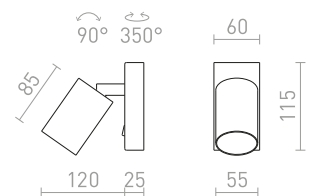





DUGME

Foco realizado en metal pintado blanco con detalles antracita.

DUGME I

230 V GU10 35 W

R12076 blanco/gris antracita

€ 58

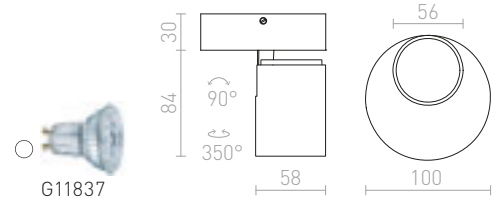

DUGME II

230 V GU10 2x35 W

R12077 blanco/gris antracita

€ 120

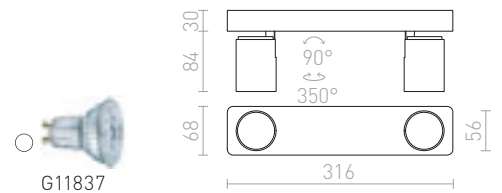

DUGME III

230 V GU10 3x35 W

R12078 blanco/gris antracita

€ 129

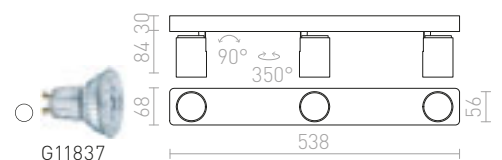



TRICA

Foco metálico minimalista para instalación en pared o techo, adecuado para fuentes de luz decorativas GU10.

TRICA I APLIQUE DE PARED

230 V GU10 25 W

R13371 blanco

€ 22

%

R13372 negro

€ 22

%



G11841

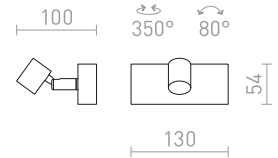

TRICA II APLIQUE DE PARED

230 V GU10 2x25 W

R13373 blanco

€ 38

%

R13374 negro

€ 38

%



G11841

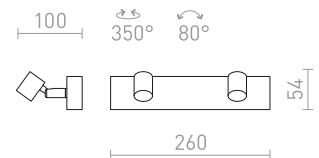

TRICA III APLIQUE DE PARED

230 V GU10 3x25 W

R13375 blanco

€ 48

%

R13376 negro

€ 48

%



G11841

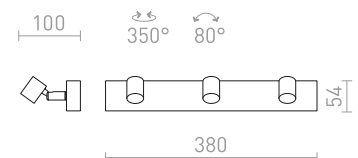





KELLY LED

Lámpara de pared o techo con foco inclinable.
La luminaria se suministra con módulos LED.

KELLY LED I DE PARED

230 V LED 12 W $\angle 24^\circ$ 3000 K 600 lm Ra 80

R12332 blanco

€ 120 →

R12333 negro

€ 120 →

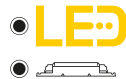
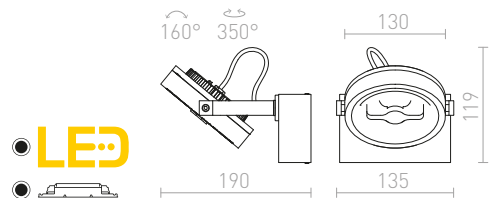

KELLY LED II DE PARED

230 V LED 2x12 W $\angle 24^\circ$ 3000 K 1200 lm Ra 80

R12334 blanco

€ 198 →

R12335 negro

€ 198 →

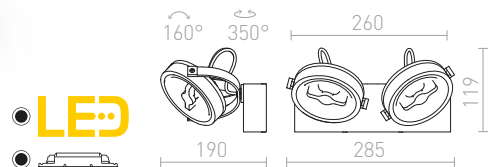

KELLY LED III DE PARED

230 V LED 3x12 W $\angle 24^\circ$ 3000 K 1800 lm Ra 80

R12336 blanco

€ 290 →

R12337 negro

€ 290 →

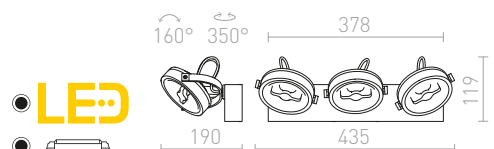



KELLY LED

Luminaria regulable semi empotrada con LED integrado y foco direccional. Sólo para instalación en techo de paneles de yeso. Atenuación TRIAC.

KELLY LED DIMM SEMI-EMPOTRADO

230 V LED 12 W $\angle 24^\circ$ 3000 K 600 lm Ra 80

R12637 blanco

€ 98

R12638 negro

€ 98

↑ 50

● Ø65

● LED

● regulable

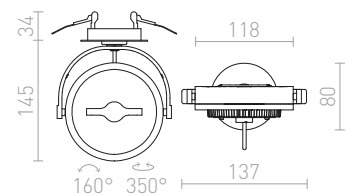





KELLY LED

Luminarias de pared/techo con foco/s direccionales y regulable TRIAC. Incluye las fuentes de luz.

KELLY LED I DIMM DE PARED

230 V LED 12 W $\angle 24^\circ$ 3000 K 600 lm Ra 90

R13104 blanco

€ 129

R13105 negro

€ 129

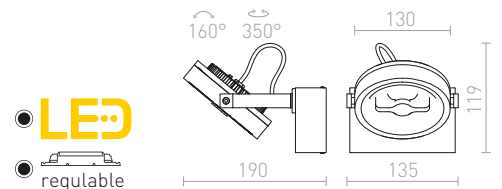

● LED
● regulable

KELLY LED II DIMM DE PARED

230 V LED 2x12 W $\angle 24^\circ$ 3000 K 1200 lm Ra 90

R13106 blanco

€ 238

R13107 negro

€ 238

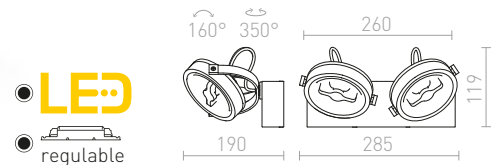

● LED
● regulable



KELLY LED III DIMM DE PARED

230 V LED 3x12 W $\angle 24^\circ$ 3000 K 1800 lm Ra 80

R13108 blanco

€ 360

R13109 negro

€ 360

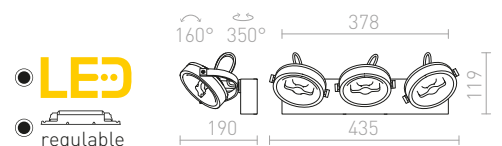

● LED
● regulable





ELISEO

Lámpara LED de superficie con cabezal giratorio en forma de platillo y difusor en color ópalo.

ELISEO II PARED O TECHO

230 V LED 2x5 W 3000 K 760 lm Ra 80

R13916 blanco

€ 138

NEW

R13917 negro

€ 138

NEW

LED

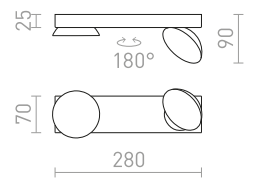

ELISEO

Lámpara de pared con cabezal giratorio en forma de platillo, LED incorporado y difusor en color ópalo.

ELISEO DE PARED

230 V LED 5 W 3000 K 320 lm Ra 80

R13914 blanco

€ 88

NEW

R13915 negro

€ 88

NEW



LED

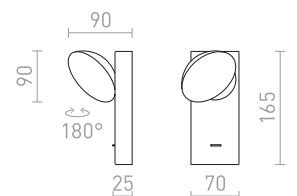



GLOSSY

Luminaria de pared con tres reflectores que pueden ser inclinados en dos ejes.

GLOSSY I

230 V LED GU10 8 W

R10542 cromo

€ 48 %

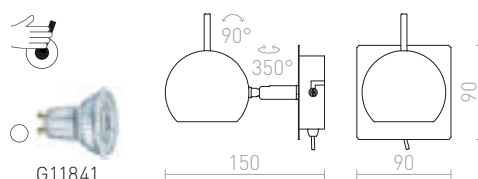

GLOSSY III

230 V LED GU10 3x8 W

R10604 cromo

€ 78 %

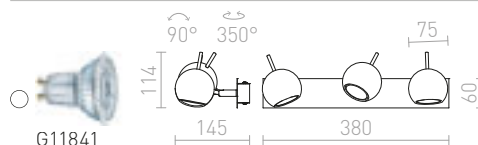

GLOSSY

Aplique con reflector en cuello de ganso. El interruptor de palanca se encuentra en la parte inferior de la base.

GLOSSY EN CUELLO DE GANSO

230 V LED GU10 8 W

R10543 cromo

€ 58 %

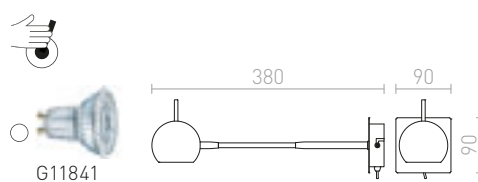



ROSITA

Apliques de pared retro para la fuente de luz de bajo consumo GU10.

ROSITA I DE PARED

230 V LED GU10 9 W

R12507 blanco/gris plata

€ 58

R12508 negro/oro

€ 58

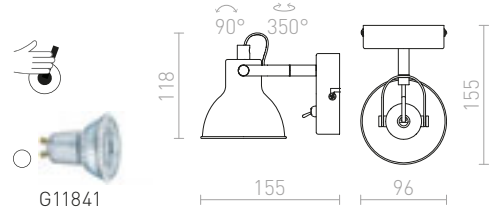

ROSITA II DE PARED

230 V LED GU10 2x9 W

R12509 blanco/gris plata

€ 88

R12510 negro/oro

€ 120

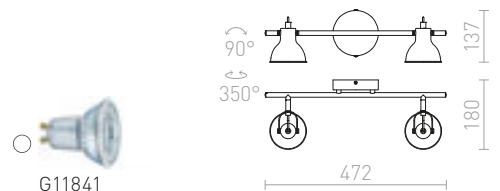



EKE

Lámpara de pared LED en cuello flexible con interruptor en la base.

EKE DE PARED

230 V LED 3 W $\angle 60^\circ$ 3000 K 100 lm Ra 80

R12944 blanco

€ 58

R12945 negro

€ 58

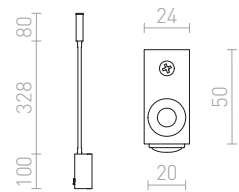
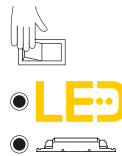

FRISCO

Lámpara de pared LED en cuello flexible con interruptor de base. El reflector rectangular permite una amplia dispersión de luz.

FRISCO W DE PARED

230 V LED 4,2 W $\angle 120^\circ$ 3000 K 300 lm Ra 80

R12942 negro

€ 98 %

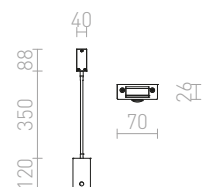



AIM

Lámpara de pared LED con brazo flexible. El interruptor táctil se encuentra en la base de la luminaria.

AIM EN CUELLO DE GANSO

230 V LED 3 W $\angle 45^\circ$ 3000 K 180 lm Ra 80

R10541 negro

€ 150

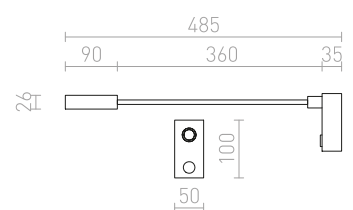



POINT

Luminaria punto de LED con cuello de ganso. El interruptor de palanca se encuentra en la parte inferior de la base.

POINT DE PARED

230 V LED 3 W $\angle 40^\circ$ 3000 K 240 lm Ra 80

R11758 níquel mate

€ 68 %

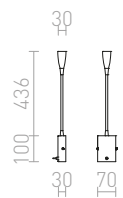



VERSA

Luminaria punto de LED con cuello de ganso. El interruptor de palanca se encuentra en la parte inferior de la base.

VERSA DE PARED

230 V LED 3 W $\angle 40^\circ$ 3000 K 240 lm Ra 80

R10602 níquel mate

€ 88

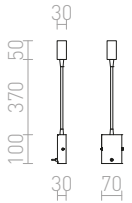

SHOW

Luminaria LED de punto con cuello de ganso para montaje en pared.

SHOW DE PARED

230 V LED 3 W 3000 K 240 lm Ra 80

R12896 blanco/cromo

€ 78

R12897 negro/cromo

€ 78

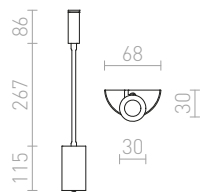

BOB

Luminaria LED de pared en cuello de ganso.

La luminaria se puede operar con un interruptor de palanca ubicado en la base de la luminaria.

BOB EN CUELLO DE GANSO

230 V/500 mA LED 3 W $\angle 45^\circ$ 3000 K 180 lm Ra 80

R10538 cromo

€ 120





KAYA

Reflector metálico de montaje en pared en cuello de ganso con interruptor en la base para bombilla rosca E27.

KAYA DE PARED

230 V E27 28 W

R12898 blanco/níquel mate

€ 48



G13026

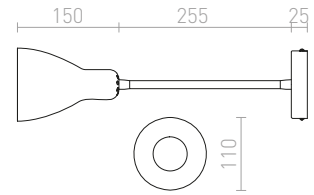

FLAP

Lámpara de pared LED con reflector circular en cuello flexible e interruptor en la base.

FLAP DE PARED

230 V LED 4,2W $\angle 120^\circ$ 3000 K 100lm Ra 80

R12943 cromo

€ 68

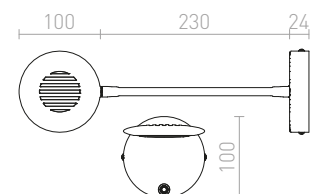



VALE

Lámpara LED de pared de cuello flexible con interruptor en la base. El cable se puede enchufar a la toma mediante un ojal en la base. El cable no está incluido en el paquete.

VALE MURO

230 V LED 3 W $\angle 30^\circ$ 3000 K 150 lm Ra 80

R13647 blanco

€ 98

R13648 negro

€ 98

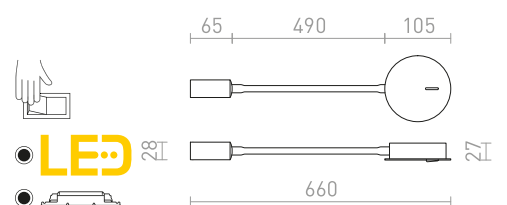



CELEIA

Proyector cilíndrico de metal para ser utilizado con una bombilla E27 adecuada.

CELEIA PARED O TECHO

230 V E27 40 W

R13901 blanco mate/níquel mate

€ 48

NEW

R13902 negro mate/cobre cepillado

€ 48

NEW

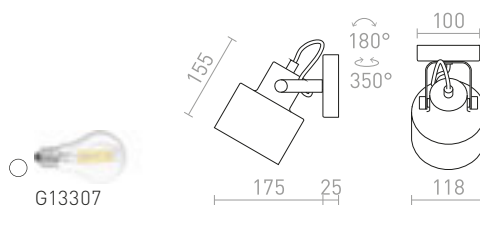

BAROQUE

Lámpara de pared con reflector ancho y base con interruptor, para fuente de luz E27.

BAROQUE DE PARED

230 V E27 28 W

R12986 negro/cromo

€ 58

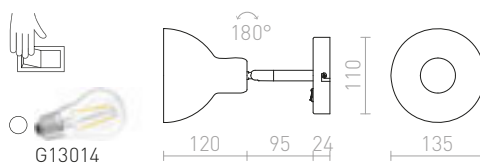



AGNETA

Pantalla redonda de metal con base giratoria, para ser utilizada con una fuente de luz E27 adecuada.

AGNETA PARED O TECHO

230 V E27 40 W

R13893 blanco

€ 48 NEW

R13894 negro

€ 48 NEW

R13895 latón cepillado/negro

€ 78 NEW

R13896 cobre cepillado/negro

€ 78 NEW

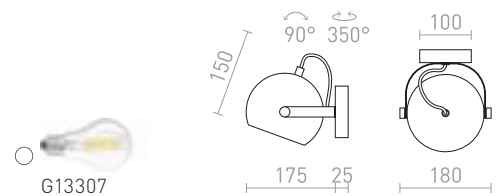

JOLI

Foco basculante de plástico para fuentes de luz LED con casquillo GU10.

JOLI I DE PARED

230 V LED GU10 10 W

R13556 negro

€ 38

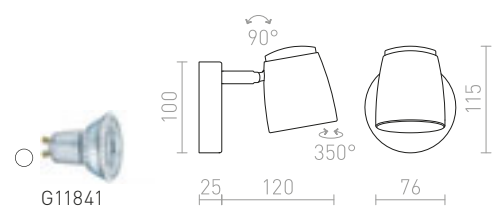



BELENOS

Foco cilíndrico minimalista para fuentes de luz GU10 sobre base redonda. Los resortes del casquillo permiten el uso de fuentes de luz de varias longitudes.

BELENOS APLIQUE DE TECHO

230 V LED GU10 9 W

R13363 blanco

€ 48

R13364 negro

€ 48

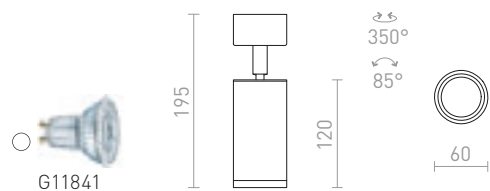

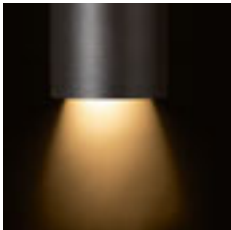

OPTIMUS

Lámpara de techo cilíndrica con posibilidad de ajustar el cono de luz mediante un sistema de zoom de 10-50°. La luminaria es apta para fuentes de luz LED con casquillo GU10. Utilice fuentes de luz con un ángulo de haz de 120° para evitar sombras no deseadas.

OPTIMUS TECHO

230 V LED GU10 9 W \angle 10-50°

R13779 blanco

€ 58

R13780 negro

€ 58

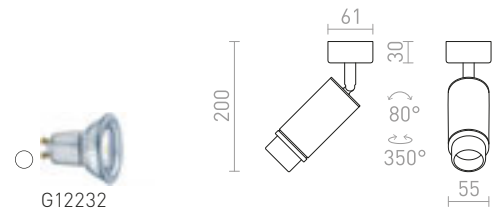

BOGARD

Foco direccional en forma de tubo con LED integrado.

BOGARD DE TECHO

230 V LED 5 W \angle 40° 3000 K 414 lm Ra 80

R12497 negro mate

€ 68

R12498 níquel mate

€ 78

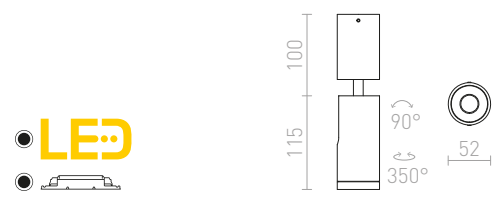

BOGARD

Luminaria de techo con un foco LED fijo y uno ajustable.

BOGARD TWIN DE TECHO

230 V LED 2x5 W \angle 40° 3000 K 700 lm Ra 80

R12499 negro mate

€ 120

R12500 níquel mate

€ 88

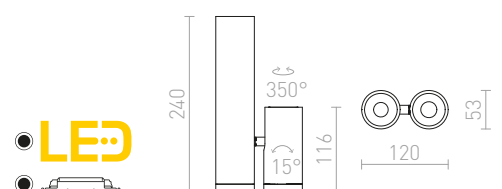



DARIO

Luz de techo cilíndrica orientable con casquillo GU10 para fuentes de luz LED, incluye pantalla decorativa de latón negro cepillado. Hay diferentes combinaciones de colores disponibles comprando pantallas adicionales en otros colores.

DARIO TECHO
230 V GU10 9 W

R13867 blanco/latón cepillado

€ 68

NEW

R13868 negro/latón cepillado

€ 68

NEW

R13869 latón cepillado

€ 78

NEW



G11841

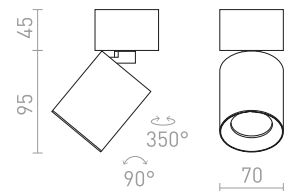

DARIO

Pantalla interior decorativa de metal en varios colores para la lampara DARIO.

DARIO ANILLO DECORATIVO

R13876 blanco

€ 8.50

NEW

R13877 negro

€ 8.50

NEW

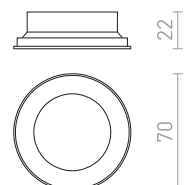
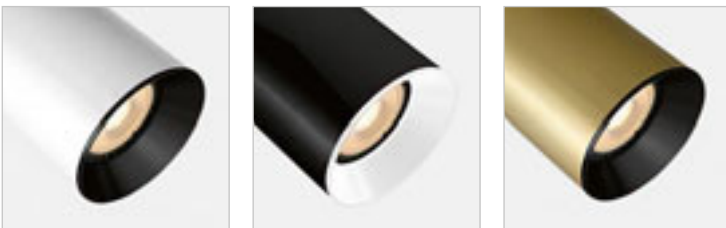



PIXIE

Lámpara direccional sobre base, para fuentes de luz LED de bajo consumo con casquillo GX53.

PIXIE INCLINABLE

230 V LED GX53 7 W

R11772 blanco/cromo

€ 138

R11773 negro/cromo

€ 138

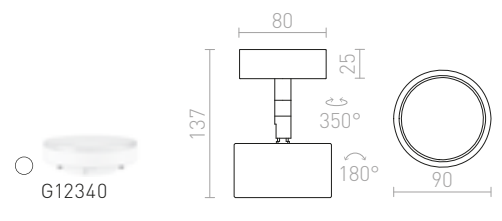

IP44



ORIT

Foco de aluminio para exteriores con función de inclinación, tiene LED integrado de 6W. El foco puede inclinarse solamente en un eje.

ORIT DE PARED

230 V LED 6 W $\angle 80^\circ$ 3000 K 315 lm Ra 80 IP44

R12033 aluminio

€ 78

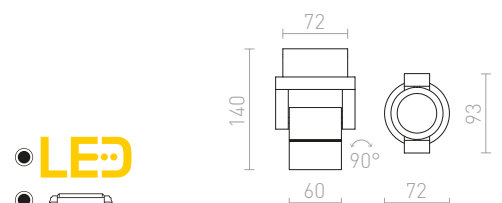



REDO

Reflector basculante fabricado en aluminio macizo.

REDO INCLINABLE

230 V GU10 50 W

R10173 aluminio

€ 35 →

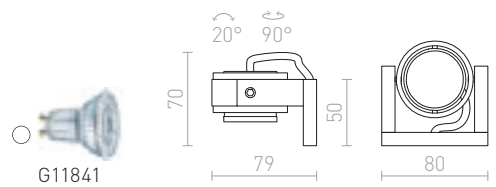

G11841



MARVEL

Luminaria cuadrada de aluminio para bombillas dicroicas, con dos brazos basculantes independientes sobre una base.

MARVEL II INCLINABLE

230 V GU10 2x50 W

R10171 aluminio

€ 48 %

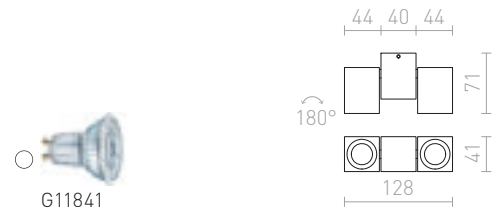

CASSIE

Aplique / plafón con reflector basculante.

CASSIE DE PARED

230 V/12 V G53 50 W

R10591 níquel mate

€ 58 %

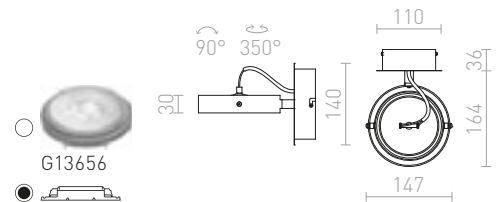

BUGSY

Lámpara de pared con reflector de cristal espejado sobre base de cromo.

BUGSY I DE PARED

230 V GU10 50 W

R10521 cristal cromado

€ 48 %

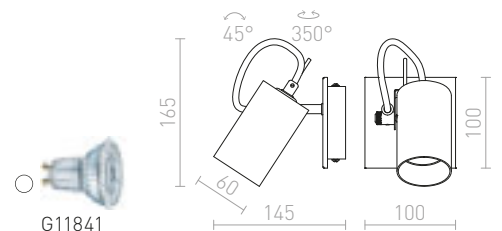

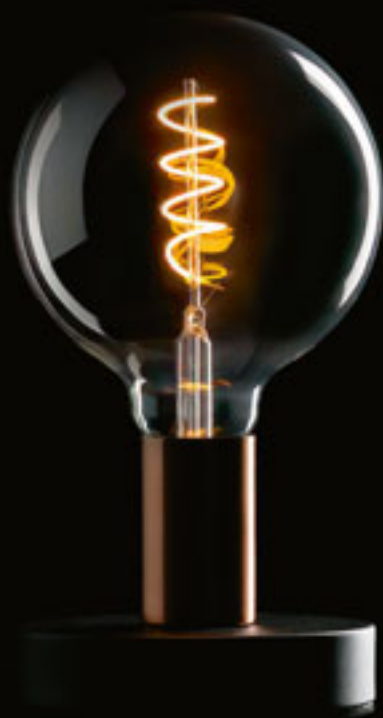

LÁMPARAS DE MESA

DECORATIVAS	322-339
DE TRABAJO	340-347

MESA DECORATIVAS

322-339



AMBITUS/ALVIS 24
322-323



ALVIS/AMBITUS 30
322-323



EL PASO
324-325



GARDETTE
324-325



ALVIS/RON 40
324-325



KEITH/ALVIS 24
326-327



KEITH/DELISA
326-327



MAUI/ALVIS 24
326-327



BROADWAY
326-327



KEITH/AMBITUS 30
328-329



MAUI/AMBITUS 30
328-329



PERTH
328-329



ESPLANADE
330-331



EDIKA
330-331



LAURA
330-331



LULU
332-333



MAUI/CONNY 15/30
332-333



NYC/CONNY 15/15
332-333



NYC/CONNY 15/30
332-333



KEITH/RON 15/20
334-335



NYC/RON 15/20
334-335



ZUMBA
334-335



NYC/TEMPO 15/30
336-337



MONACO
336-337



PLAZA S
336-337



PLAZA M
336-337



CAMINO
338-339



CAMINO
338-339



HEIDI
338-339



ALGOT
338-339

MESA DE TRABAJO



MONTANA
340-341



RITZY
340-341



NIZZA
340-341

340-347



GARBO
342-343



ANIKA
342-343



CELEIA
342-343



BUGSY
344-345



JOLI
344-345



ROSITA
344-345



FRISCO T
344-345



FADO
346-347



VIPER TL
346-347



COZY
346-347



TAPIO
346-347





AMBITUS/ALVIS

Lámpara de mesa con pantalla de tela y una elegante base de bambú. Apta para fuentes de luz LED E27.

AMBITUS/ALVIS 24 DE MESA

230 V LED E27 7 W

R14040 blanco crema/bambú

€ 150 **NEW**



G13015

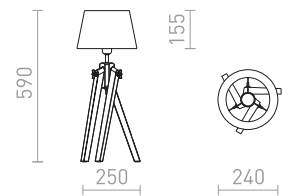

240



ALVIS/AMBITUS

Lámpara de mesa con pantalla de tela y una elegante base de bambú. Apta para fuentes de luz LED E27.

ALVIS/AMBITUS 30 DE MESA

230 V LED E27 11 W

R14041 polialgodón blanco/bambú

€ 178 **NEW**



G13026

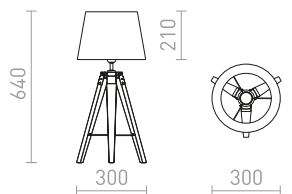

300



ALVIS/RON

Lámpara de mesa con pantalla de tela y una elegante base de bambú. Apta para fuentes de luz LED E27.

ALVIS/RON 40 DE MESA

230 V LED E27 11 W

R14042 polialgodón blanco/bambú

€ 188 **NEW**

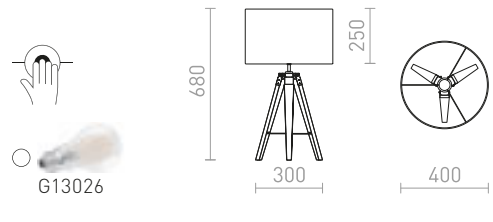

GARDETTE

Lámpara de mesa en trípode con ajuste de altura, pantalla textil y casquillo E27.

GARDETTE DE MESA

230 V E27 42 W

R12488 negro/aluminio

€ 150 **%**

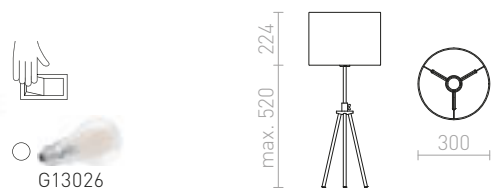



EL PASO

Lámpara de mesa sobre una base de bambú con pantalla textil. Se suministra desmontado, requiere montaje.

EL PASO LÁMPARA DE MESA

230 V E14 11 W

R13338 gris/bambú

€ 68 %



G12243

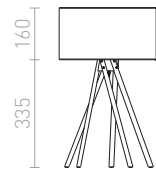



KEITH/ALVIS

Lámpara de mesa con pantalla de tela y puerto USB integrado en la base, que es de imitación de madera de haya con detalles lacados en blanco. Apta para fuentes de luz LED E27.

KEITH/ALVIS 24 DE MESA CON USB

230 V LED E27 7 W

R14038 blanco crema/haya

€ 138 **NEW**



G13015

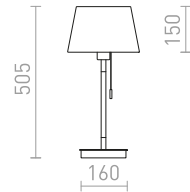

KEITH/DELISA

Lámpara de mesa con pantalla decorativa adornada con botones de colores y puerto de USB integrado en la base, que está fabricada en imitación de madera de haya con detalles lacados en blanco. Apta para fuentes de luz LED E27.

KEITH/DELISA DE MESA CON USB

230 V LED E27 7 W

R14037 blanco/botones/haya

€ 129 **NEW**



G13015





MAUI/ALVIS

Lámpara de mesa con base de madera y pantalla de tela. Apta para fuentes de luz LED E27.

MAUI/ALVIS 24 DE MESA

230 V LED E27 7 W

R14033 blanco crema/madera

€ 98 **NEW**



G13015

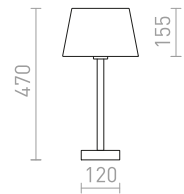

BROADWAY

Lámpara de mesa con pantalla textil blanca y base cromada.

BROADWAY DE MESA

230 V E27 42 W

R11986 blanco/cromo

€ 178 **➔**



G13026





KEITH/AMBITUS

Lámpara de mesa con pantalla de tela y puerto USB integrado en la base, que es de imitación de madera de haya con detalles lacados en blanco. Apta para fuentes de luz LED E27.

KEITH/AMBITUS 30 DE MESA CON USB

230 V LED E27 11 W

R14039 polialgodón blanco/haya

€ 178 **NEW**



G13026

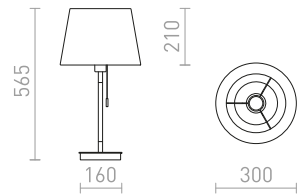

MAUI/AMBITUS

Lámpara de mesa con base de madera y pantalla de tela. Apta para fuentes de luz LED E27.

MAUI/AMBITUS 30 DE MESA

230 V LED E27 11 W

R14035 polialgodón blanco/madera

€ 120 **NEW**



G13026

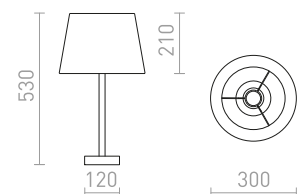

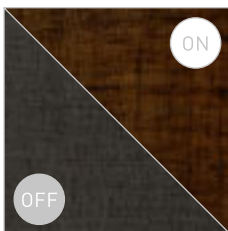
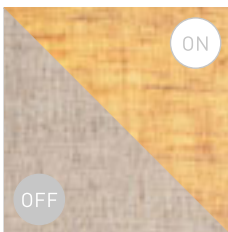

PERTH

Lámpara de mesa con pantalla textil cuadrada y base metálica.

PERTH MESA

230 V E27 15 W

R13663 beige/blanco

€ 150

R13664 negro/negro

€ 150



G13307

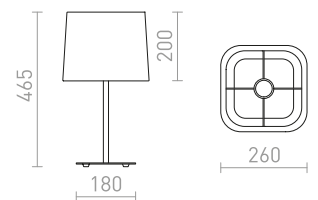



EDIKA

Lámpara de mesa con soporte telescópico hecho de níquel, tiene una pantalla textil y un casquillo E27.

EDIKA DE MESA

230 V E27 42 W

R12665 marrón/níquel mate

€ 138 →



G13026

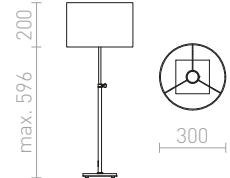

LAURA

Lámpara de mesa decorativa con pantalla textil.

LAURA LÁMPARA DE MESA

230 V E27 28 W

R13324 gris beige

€ 48 →

R13325 negro

€ 58 →



G13026

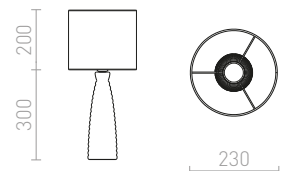



ESPLANADE

Lámpara de mesa con pie telescópico para ajustar la altura y pantalla doble textil.

ESPLANADE DE MESA

230 V E27 42 W

R12484 negro transparente/blanco/cromo

€ 268



G13026

max. 525

218

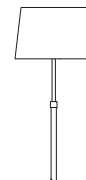

327





NYC/CONNY

Lámpara de mesa con pantalla de tela sobre base de metal.
Apta para fuentes de luz LED E27.

NYC/CONNY 15/15 DE MESA

230 V LED E27 7 W

	R14047 polialgodón blanco/cromo	€ 120	NEW
	R14048 polialgodón blanco/níquel	€ 120	NEW

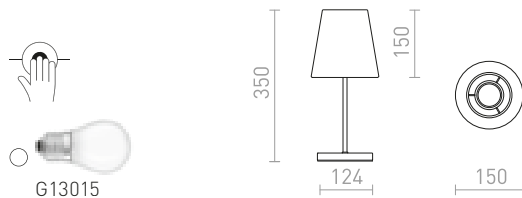

NYC/CONNY 15/30 DE MESA

230 V LED E27 7 W

	R14049 polialgodón blanco/cromo	€ 120	NEW
	R14050 polialgodón blanco/níquel	€ 120	NEW
	R14051 monaco paloma gris/plata PVC/cromo	€ 150	NEW
	R14052 monaco paloma gris/plata PVC/níquel	€ 150	NEW
	R14053 monaco gasolina azul/plata PVC/cromo	€ 150	NEW
	R14054 monaco gasolina azul/plata PVC/níquel	€ 150	NEW

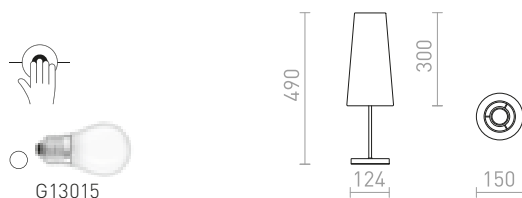



MAUI/CONNY

Lámpara de mesa con base de madera y pantalla de tela. Apta para fuentes de luz LED E27.

MAUI/CONNY 15/30 DE MESA

230 V LED E27 7 W

R14034 polialgodón blanco/madera

€ 120

NEW



G13015

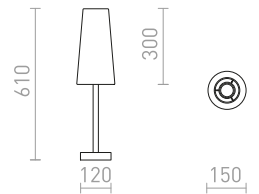

LULU

Lámpara de mesa con pantalla cónica textil y casquillo E27. La base está conformada por una elegante combinación de colores cromo y negro.

LULU DE MESA

230 V E27 28 W

R12464 blanco/negro/cromo

€ 129

R12465 negro/cromo

€ 129



G13026

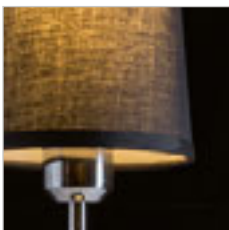
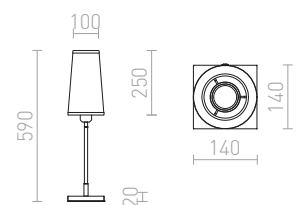











NYC/RON

Lámpara de mesa con pantalla de tela sobre base de metal.
Apta para fuentes de luz LED E27.

NYC/RON 15/20 DE MESA

230 V LED E27 7 W

	R14055 polialgodón blanco/cromo	€ 120	NEW
	R14056 polialgodón blanco/níquel	€ 120	NEW
	R14057 monaco paloma gris/plata PVC/cromo	€ 150	NEW
	R14058 monaco paloma gris/plata PVC/níquel	€ 150	NEW
	R14059 monaco gasolina azul/plata PVC/cromo	€ 150	NEW
	R14060 monaco gasolina azul/plata PVC/níquel	€ 150	NEW
	R14061 polialgodón negro/cromo	€ 120	NEW
	R14062 polialgodón negro/níquel	€ 120	NEW

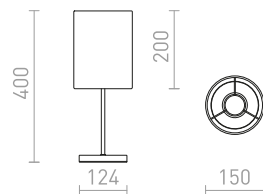



KEITH/RON

Lámpara de mesa con pantalla de tela y puerto USB integrado en la base, que es de imitación de madera de haya con detalles lacados en blanco. Apto para fuentes de luz LED E27.

KEITH/RON 15/20 DE MESA CON USB

230 V LED E27 7 W

R14036 polialgodón blanco/haya

€ 158

NEW



G13026

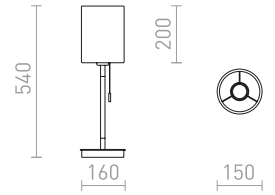

ZUMBA

Pequeña lámpara de mesa sobre una base de madera con pantalla de plástico. Se suministra desmontado, requiere montaje.

ZUMBA LÁMPARA DE MESA

230 V E14 11 W

R13320 PVC blanco/madera/cromo

€ 48

%



G11849

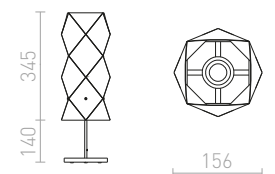



MONACO

Lámpara de escritorio compacta con pantalla textil negra y base de cromo.

MONACO DE MESA

230 V E27 28 W

R12040 negro/cromo

€ 32 

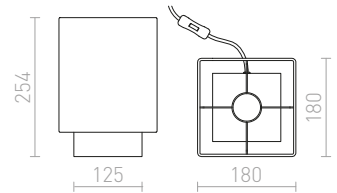
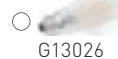



PLAZA

Lámpara de mesa con pantalla textil estructurada.

PLAZA S DE MESA

230 V E27 42 W

R11973 blanco/cromo

€ 158

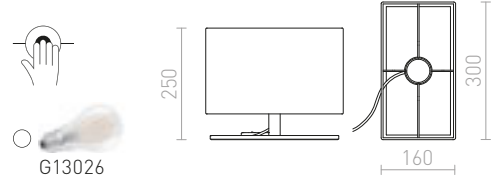

PLAZA M DE MESA

230 V E27 42 W

R11983 blanco/cromo

€ 215

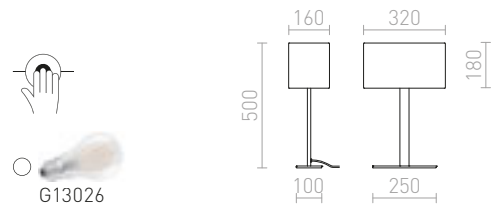

NYC/TEMPO

Lámpara de mesa con pantalla de tela sobre base de metal. Apta para fuentes de luz LED E27.

NYC/TEMPO 15/30 DE MESA

230 V LED E27 7 W

R14063 polialgodón blanco/cromo

€ 129

NEW

R14064 polialgodón blanco/níquel

€ 129

NEW

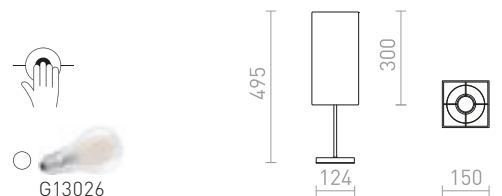



ALGOT

Pie de lámpara de mesa para ser utilizada con fuente de luz E27 decorativa adecuada.

ALGOT DE MESA

230 V E27 40 W

R13907 negro/cobre cepillado

€ 25 **NEW**



G13459

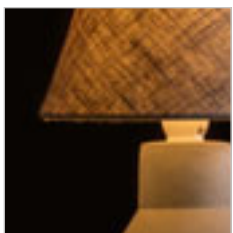
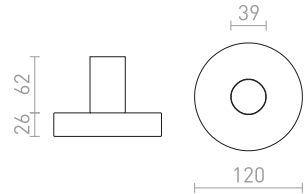

HEIDI

Lámpara de mesa decorativa hecha de hormigón con pantalla textil para casquillo E14.

HEIDI DE MESA

230 V E14 12 W

R12379 natural/hormigón

€ 48



G12243

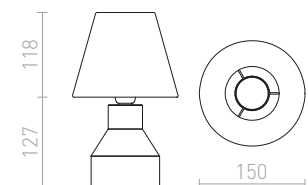



CAMINO

Lámpara de mesa minimalista de forma cilíndrica que incluye una pantalla textil. Cada base tiene un patrón único.

CAMINO LÁMPARA DE MESA CON PANTALLA
230 V E27 28 W

R13294 blanco/teraso decor

€ 78

R13295 blanco/cemento

€ 78



G13026

200
135

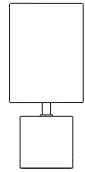

150



CAMINO

Lámpara de mesa minimalista de forma cilíndrica, para bombillas decorativas. Cada base tiene un patrón único.

CAMINO LÁMPARA DE MESA

230 V E27 28 W

R13293 teraso decor

€ 48



G13311

110

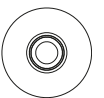
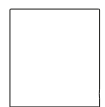

100



RITZY

Lámpara de mesa en acabado cromado negro y pantalla textil con ajuste telescópico de altura. Casquillo E27.

RITZY DE MESA

230 V E27 42 W

R12486 negro/cromo

€ 178 %



G13026

max. 550
150

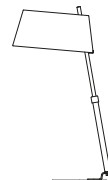

400

330



NIZZA

Lámpara de mesa con brazo orientable de madera, base de metal lacado y pantalla de tela. Incluye un cable de alimentación trenzado negro.

NIZZA DE MESA

230 V LED E14 7 W

R14031 polialgodón blanco/madera

€ 178 **NEW**

R14032 polialgodón negro/madera

€ 188 **NEW**

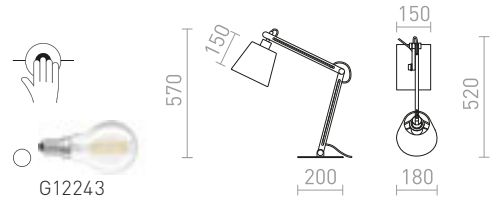

MONTANA

Lámpara de mesa con brazo regulable y pantalla textil.

MONTANA MESA

230 V E27 28 W

R13283 blanco/negro/cromo

€ 320 **➤**

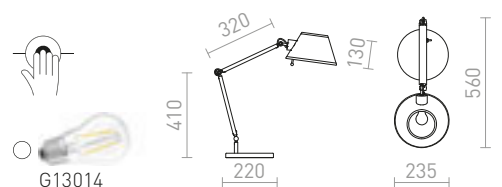



ANIKA

Lámpara de mesa de metal con brazo ajustable, para ser utilizada con una fuente de luz E27 adecuada.

ANIKA DE MESA

230 V E27 40 W

R13905 blanco mate/níquel mate

€ 68

NEW

R13906 negro mate/níquel mate

€ 68

NEW

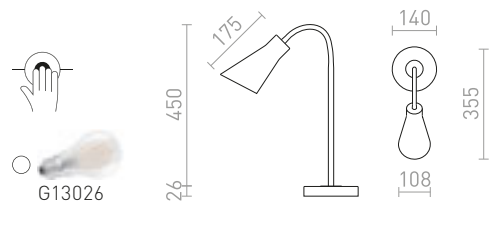

CELEIA

Lámpara de mesa cilíndrica de metal para ser utilizada con una fuente de luz E27 adecuada.

CELEIA DE MESA

230 V E27 40 W

R13903 blanco mate/níquel mate

€ 98

NEW

R13904 negro mate/cobre cepillado

€ 98

NEW

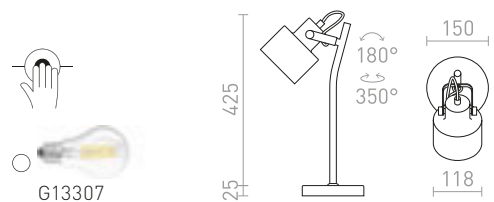



GARBO

Lámpara de mesa articulada on casquillo E27.

GARBO DE MESA

230 V E27 28 W

R12675 negro/cromo

€ 58



G13026

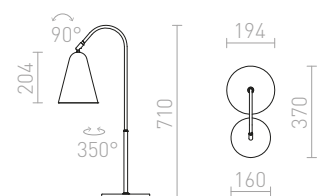



BUGSY

Lámpara de mesa con pantalla de cristal espejado, inclinable en un eje.

BUGSY DE MESA

230 V GU10 50 W

R10519 cristal cromado

€ 120 %



G11841

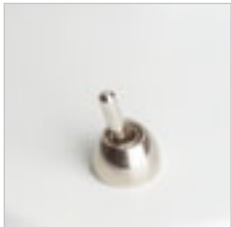
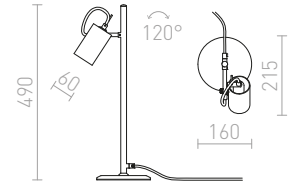

ROSITA

Lámpara de escritorio al estilo retro para bombillas de bajo consumo GU10.

ROSITA DE MESA

230 V LED GU10 9 W

R12512 negro/oro

€ 120



G11841

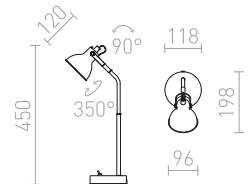

FRISCO

Lámpara LED de escritorio en cuello flexible con interruptor en el pedestal y cabeza rectangular para una amplia dispersión.

FRISCO T DE MESA

230 V LED 4,2 W $\angle 120^\circ$ 3000 K 300 lm Ra 80

R12940 negro

€ 120 %

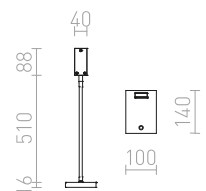



JOLI

Lámpara pequeña de mesa de plástico para fuentes de luz LED con casquillo GU10.

JOLI MESA

230 V LED GU10 10 W

R13558 negro

€ 58



G11841

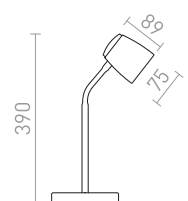



TAPIO

Lámpara de mesa con reflector cilíndrico direccional y LED incorporado.

TAPIO LÁMPARA DE MESA

230 V LED 4,5 W 3000 K 350 lm Ra 80

R13429 negro

€ 98

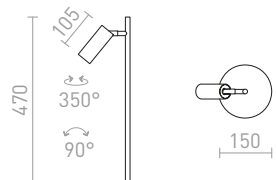
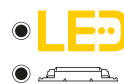



FADO

Lámpara de mesa con diseño rectangular con un reflector LED regulable.

FADO DE MESA

230 V LED 3 W $\angle 45^\circ$ 3000 K 110 lm Ra 80

R12474 negro

€ 120

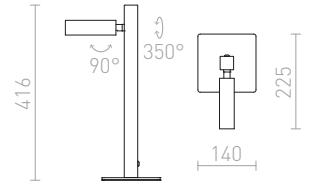

VIPER

Lámpara de escritorio cromada con reflector LED deslizante negro y cable textil rojo.

VIPER TL

230 V LED 3 W $\angle 60^\circ$ 3000 K 100 lm Ra 80

R12462 negro/cromo

€ 150

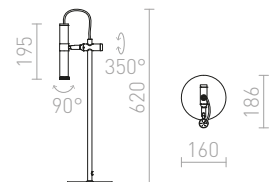

COZY

Elegante lámpara de escritorio con LED integrado en trípode con acabado en metal mate. El transformador se encuentra en el enchufe de la pared.

COZY DE MESA

230 V LED 3,5 W 3000 K 240 lm Ra 80

R11759 níquel mate

€ 58

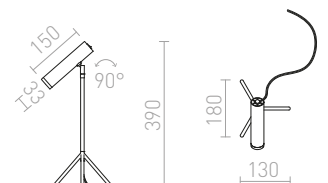



LÁMPARAS DE PIE

DECORATIVAS	352-367
PARA LEER	368-371

DE PIE DECORATIVAS

352-367



ALVIS/AMBITUS 46
352-353



ALVIS/ILUSION
352-353



AMBITUS 46
352-353



ALVIS/RIDICK
352-353



LUTON/ILUSION
354-355



LUTON/RIDICK
354-355



BOULOGNE
354-355



GARDETTE
356-357



LUTON/RON 55
356-357



NAUTIC
356-357



DANTE
358-359



RITZY
358-359



ESPLANADE
358-359



EDIKA
360-361



ETESIAN
360-361



NYC/ILUSION
360-361



NYC/RON 40/25
362-363



CORTINA/JAKARANDA
362-363



LULU
364-365



NYC/CONNY 25
364-365



NYC/CONNY 35
364-365



PLAZA
366-367



NYC/TEMPO 30/19
366-367



PERTH
366-367

DE PIE PARA LEER

368-371



PRAGMA
368-369



VARIA
368-369



ROSITA
368-369



STIG
368-369



VIPER FL
370-371



BUGSY
370-371



FADO
370-371



ALVIS/AMBITUS

Lámpara de pie con pantalla de tela y una elegante base de bambú y es de altura regulable. Apta para fuentes de luz LED E27.

ALVIS/AMBITUS 46 EN PIE

230 V LED E27 11 W

R14044 blanco crema/bambú

€ 320 **NEW**



G13461

1000 - 1460



620

240



460



ALVIS/ILUSION

Lámpara de pie con pantalla fabricada en lámina de cromo. Tiene una base de bambú y es de altura regulable. Apta para fuentes de luz LED E27.

ALVIS/ILUSION EN PIE

230 V LED E27 11 W

R14045 hoja de cromo/bambú

€ 320 **NEW**



G13461

1090 - 1500



620

330



450



ALVIS/RIDICK

Lámpara de pie con pantalla realizada en lámina de cromo negra con interior dorado. Tiene una base de bambú y es de altura regulable. Apta para fuentes de luz LED E27.

ALVIS/RIDICK EN PIE

230 V LED E27 11 W

R14046 negro brillante/hoja dorada/bambú € 278 NEW

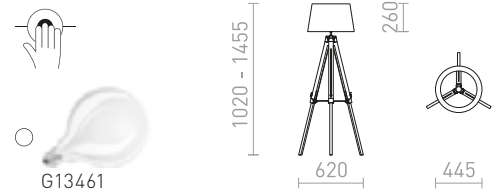

AMBITUS

Lámpara de pie con pantalla de tela y una elegante base de bambú. Apta para fuentes de luz LED E27.

AMBITUS 46 EN PIE

230 V LED E27 11 W

R14043 blanco crema/bambú € 380 NEW

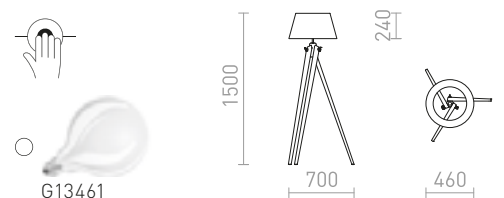



LUTON/ILUSION

Elegante lámpara de pie con pantalla fabricada en lámina de cromo. Tiene una base de metal lacado y es de altura regulable con accesorios de latón. Apto para fuentes de luz LED E27.

LUTON/ILUSION EN PIE

230 V LED E27 11 W

R14065 hoja de cromo/negro/metal

€ 248 **NEW**



G13026

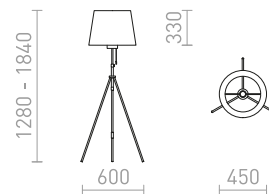

LUTON/RIDICK

Elegante lámpara de pie con pantalla fabricada en lámina de cromo negra con el interior dorado. Tiene una base de metal lacado y es de altura regulable con accesorios de latón. Apta para fuentes de luz LED E27.

LUTON/RIDICK EN PIE

230 V LED E27 11 W

R14066 negro brillante/hoja dorada/negro/metal

€ 215 **NEW**



G13026

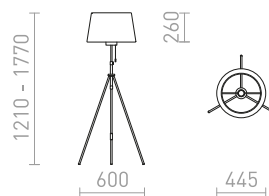

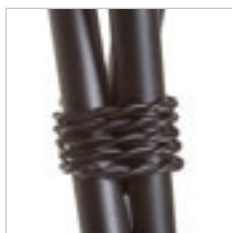

BOULOGNE

Lámpara de pie sobre un trípode con pantalla doble en color negro.

BOULOGNE EN PIE

230 V E27 28 W

R12674 negro

€ 290 



G13461

1500
285

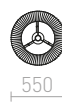

550



GARDETTE

Lámpara de pie en trípode con ajuste de altura, pantalla y textil casquillo E27.

GARDETTE EN PIE

230 V E27 42 W

R12489 negro/aluminio

€ 360 %



G13029

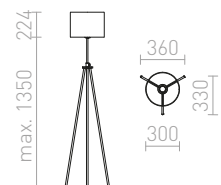



LUTON/RON

Elegante lámpara de pie con pantalla de tela. Tiene una base de metal lacado y es de altura regulable con accesorios de latón. Apta para fuentes de luz LED E27.

LUTON/RON 55 EN PIE

230 V LED E27 11 W

R14067 polialgodón blanco/negro/metal

€ 268 NEW

R14068 polialgodón negro/negro/metal

€ 268 NEW



G13026

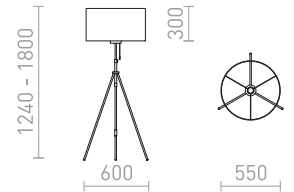

NAUTIC

Lámpara de pie al estilo retro en un trípode y con un reflector ajustable para bombillas E27.

NAUTIC LÁMPARA DE PIE

230 V E27 20 W

R13394 negro/cromo

€ 178 ➔



G13020

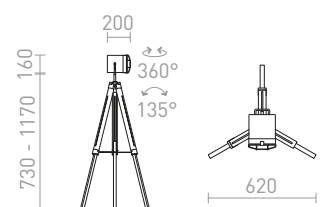



RITZY

Lámpara de pie en acabado cromado negro y pantalla textil con ajuste telescópico de altura. Casquillo E27.

RITZY EN PIE
230 V E27 42 W

R12487 negro/cromo

€ 560 %



max. 1495 210

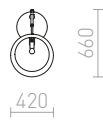



DANTE

Lámpara maciza de pie de diseño adecuada para interiores espaciosos. Combinación de madera, metal y pantalla de textil.

DANTE SUELO

230 V E27 25 W

R13653 negro/madera

€ 620

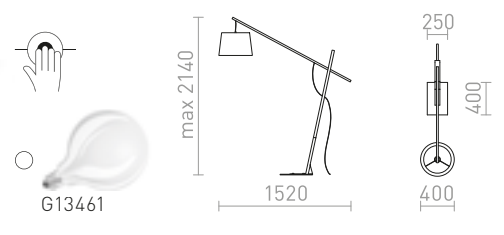

ESPLANADE

Lámpara de pie con regulación telescópica para el ajuste de altura y doble pantalla textil.

ESPLANADE EN PIE

230 V E27 42 W

R12485 negro transparente/blanco/cromo

€ 520

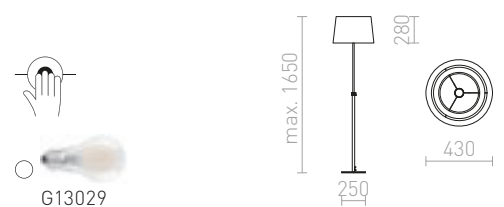



EDIKA

Lámpara de pie con soporte telescópico hecho de níquel, con pantalla textil y un casquillo E27.

EDIKA EN PIE
230 V E27 42 W

R12666 marrón/níquel mate

€ 198



G13026

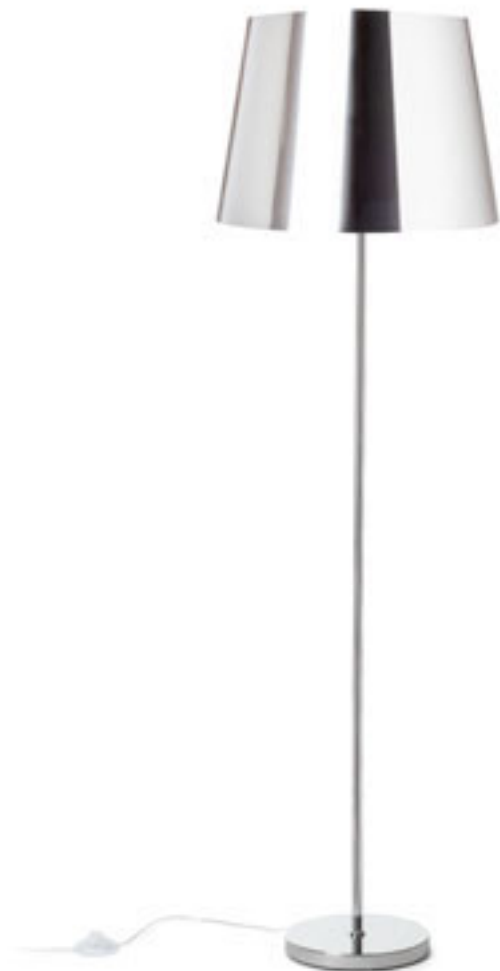
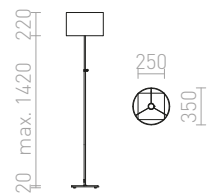

NYC/ILUSION

Lámpara de pie con base cromada y pantalla de lámina de cromo. Apta para fuentes de luz LED E27.

NYC/ILUSION EN PIE
230 V LED E27 11 W

R14073 hoja de cromo/cromo

€ 198 **NEW**



G13026

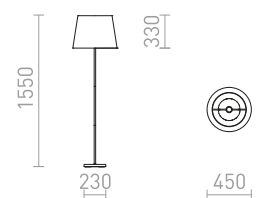



ETESIAN

Sutil lámpara de pie con pantalla textil y casquillo E27.

ETESIAN EN PIE

230 V E27 28 W

R12470 negro

€ 178

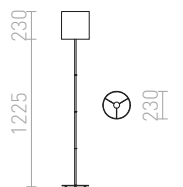



CORTINA/JAKARANDA

Lámpara de pie con base de metal lacado y pantalla de tela con superficie geométrica en 3D. Apta para fuentes de luz LED E27.

CORTINA/JAKARANDA EN PIE

230 V LED E27 11 W

R14069 blanco/blanco/textil/metal

€ 188 NEW

R14070 negro/blanco/textil/metal

€ 188 NEW

R14071 blanco/negro/textil/metal

€ 188 NEW

R14072 negro/negro/textil/metal

€ 188 NEW



G13026

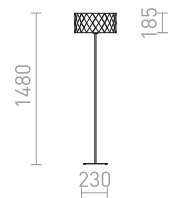

400



NYC/RON

Lámpara de pie con base cromada y pantalla de tela. Apta para fuentes de luz LED E27.

NYC/RON 40/25 EN PIE

230 V LED E27 11 W

	R14079 polialgodón blanco/cromo	€ 188 NEW
	R14080 albaricoque Chintz/cromo	€ 188 NEW
	R14081 Chintz gris claro/cromo	€ 188 NEW
	R14082 monaco paloma gris/plata PVC/cromo	€ 248 NEW
	R14083 monaco gasolina azul/plata PVC/cromo	€ 248 NEW
	R14084 polialgodón negro/cromo	€ 188 NEW

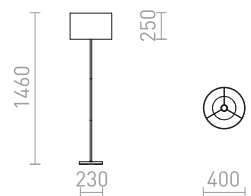



LULU

Lámpara de pie con pantalla cónica textil y casquillo E27. La base está conformada por una elegante combinación de colores cromo y negro.

LULU EN PIE

230 V E27 28 W

R12466 blanco/negro/cromo

€ 238

R12467 negro/cromo

€ 238



G13029

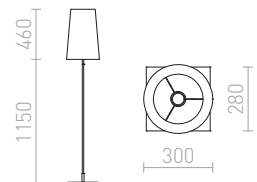



NYC/CONNY

Lámpara de pie con base cromada y pantalla de tela. Apta para fuentes de luz LED E27.

NYC/CONNY 25 EN PIE

230 V LED E27 7 W



R14074

polialgodón blanco/cromo

€ 178 **NEW**

R14075

monaco gasolina azul/plata PVC/cromo

€ 229 **NEW**



G13026

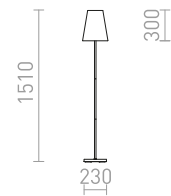

250



NYC/CONNY

Lámpara de pie con base cromada y pantalla de tela. Apta para fuentes de luz LED E27.

NYC/CONNY 35 EN PIE

230 V LED E27 11 W



R14076

polialgodón blanco/cromo

€ 198 **NEW**

R14077

monaco paloma gris/plata PVC/cromo

€ 278 **NEW**

R14078

monaco gasolina azul/plata PVC/cromo

€ 278 **NEW**



G13026

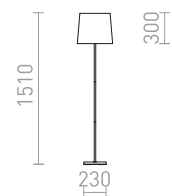

350



NYC/TEMPO

Lámpara de pie con base cromada y pantalla de tela.
Apta para fuentes de luz LED E27.

NYC/TEMPO 30/19 EN PIE

230 V LED E27 11 W

R14085 polialgodón blanco/cromo

€ 188 **NEW**



G13026

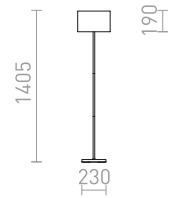

300



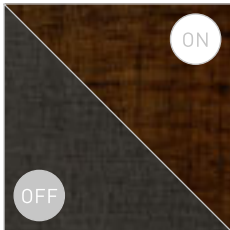
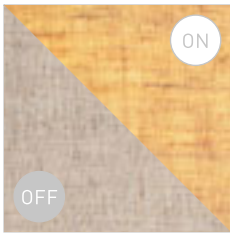

PERTH

Lámpara de pie con pantalla textil cuadrada y base metálica.

PERTH SUELO
230 V E27 20 W

R13665 beige/blanco

€ 268

R13666 negro/negro

€ 268



G13029

1550



270



370

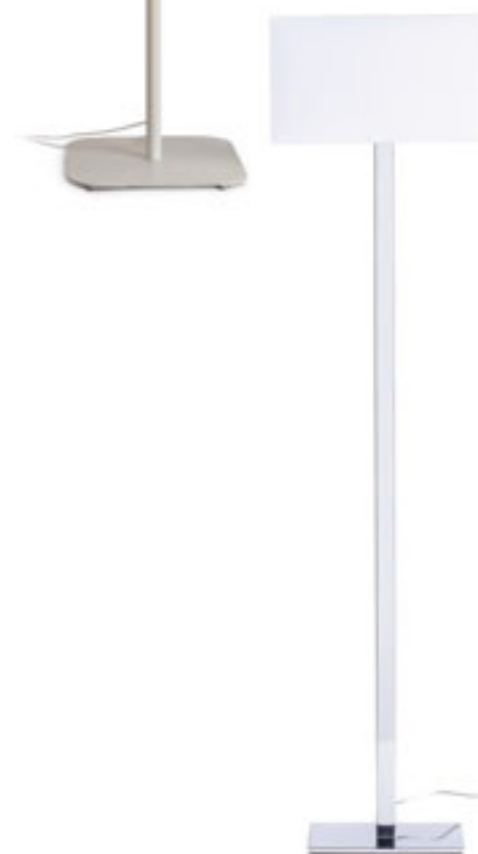

PLAZA

Lámpara de pie con pantalla textil estructurada.

PLAZA EN PIE
230 V E27 42 W

R11984 blanco/cromo

€ 620



G13026

1400

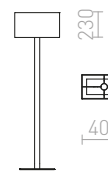

230

230

400

300x150



STIG

Elegante lámpara de pie LED en color negro con junta en color latón. Se puede alternar la intensidad de la luz utilizando un interruptor en el cable entre: 10%, 40% o 100%.

STIG EN PIE

230 V LED 8,4 W $\angle 34^\circ$ 3000 K 447 lm Ra 80

R13942 negro

€ 238 **NEW**

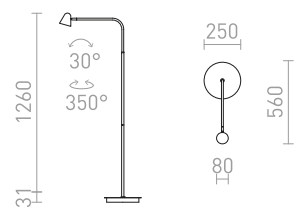



ROSITA

Lámpara de pie al estilo retro para ser usada con bombilla de bajo consumo E27.

ROSITA EN PIE
230 V E27 12 W

R12514 negro/oro

€ 158 %



G13014

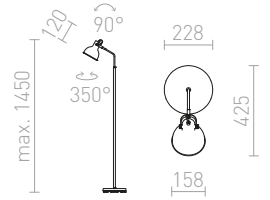

PRAGMA

Lámpara de pie con casquillo E27.

PRAGMA EN PIE
230 V E27 28 W

R12989 negro/cromo

€ 150 ▶



G13014

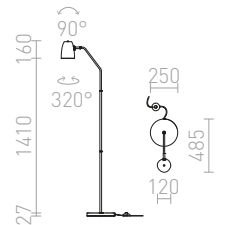

VARIA

Lámpara de pie elegante con reflector cilíndrico para bombilla LED con casquillo GU10. El interruptor está ubicado en la parte trasera del reflector.

VARIA SUELO
230 V LED GU10 9 W

R13660 negro/latón

€ 198



G11841

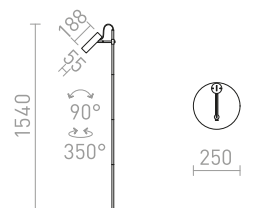



VIPER

Lámpara de pie cromada con dos LED deslizantes negros, que son controlados individualmente por interruptores en cables de alimentación de color rojo. Ambos cables están conectados a las tomas de corriente.

VIPER FL

230 V LED 2x3 W $\angle 60^\circ$ 3000 K 200 lm Ra 80

R12463 negro/cromo

€ 248 %

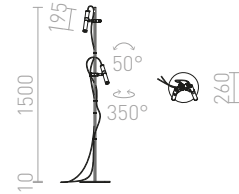
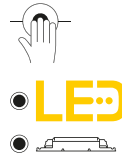

FADO

Lámpara de pie con diseño rectangular con dos focos LED regulables.

FADO EN PIE

230 V LED 2x3 W $\angle 45^\circ$ 3000 K 220 lm Ra 80

R12475 negro

€ 278 %

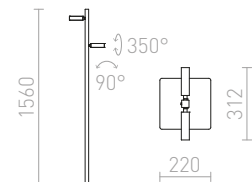
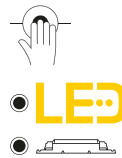

BUGSY

Lámpara de pie con pantallas de vidrio individuales e inclinables en un eje.

BUGSY DE PIE

230 V GU10 3x50 W

R10520 cristal cromado

€ 178 %

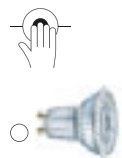

G11841

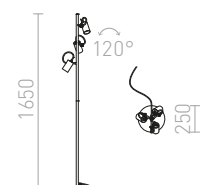





LUCES EMPOTRADAS

MODULAR	384-389
LED DE BAÑO	390-397
DE BAÑO	398-405
DECORATIVAS	406-417
DE YESO	418-427
SIN MARCO	428-431
CONJUNTOS	432-441
CIRCULAR	442-443
ANGULAR	444-447
FINO	448-463
DE PARED	464-481



EMPOTRADO MODULAR



SHARM BASE
384-385



SHARM PLUS
384-385



SHARM R I
386-387

384-389



SHARM R II
386-387



SHARM R III
386-387



SHARM SQ I
388-389



SHARM SQ II
388-389



SHARM SQ III
388-389

EMPOTRADO LED DE BAÑO



RINO
390-391



WATERBOY R
390-391



WATERBOY SQ
390-391

390-397



NAVY
390-391



INEZ R
392-393



INEZ SQ
392-393



MERGO R
392-393



BELLA LED
392-393



AMIGA R
394-395



AMIGA SQ
394-395



TOLEDO R
394-395



TOLEDO SQ
394-395



OWEN
394-395



BELI R 10
396-397



BELI R 21
396-397



BELI SQ 10
396-397



BELI SQ 21
396-397

EMPOTRADO DE BAÑO

398-405



MAJESTIC
398-399



EQUA
398-399



APRIORI
398-399



BERMUDA
398-399



ACUA
400-401



BELLA GU10
400-401



VERO
400-401



ASTOR SQ
402-403



SPLASH R
402-403



SPLASH SQ
402-403



LEROY R
404-405



LEROY SQ
404-405



INCA R
404-405



ISLA
404-405



BRAN
404-405

EMPOTRADO DECORATIVAS

406-417



MARENGA RB1 40
406-407



MARENGA SQB1 40
406-407



MARENGA RR1 40
408-409



MARENGA RR3 60
408-409



MARENGA RR4 90
408-409



MARENGA SQR3 60
408-409



MARENGA RD4 52
410-411



MARENGA RD3 60
410-411



MARENGA RD1 73
410-411



MARENGA RW1 30
412-413



MARENGA RT1 40
412-413



MARENGA RL1 40
412-413



MARENGA RD5 28
414-415



MARENGA RD6 96
414-415



MARENGA RC1 98
414-415



MARENGA RW2 60
414-415



KAY SQ
416-417



KAY R
416-417



BIANCA SQ
416-417

EMPOTRADO DE YESO



DAG R 83
418-419



DANDY R
418-419



QUO R
418-419



QUO R II
418-419



DANDY SQ
420-421



QUO SQ I
420-421



QUO SQ II
420-421



DINGO S
422-423



DINGO GU10 II
422-423



DINGO R
424-425



DINGO II
424-425



DINGO TUB
426-427



DINO SQ G53
426-427



DINO SQ GU10
426-427



DAN SQ 80
426-427



MIA R
426-427

EMPOTRADO SIN MARCO



IPSO SQ frameless
428-429



IPSO R frameless
428-429



IPSO R
428-429

428-431



COIMBRA
428-429



ELECTRA I
430-431



ELECTRA I
430-431



ELECTRA II
430-431

EMPOTRADO CONJUNTOS



ZIZI I
432-433



ZIZI II
432-433



KELLY LED
432-433

432-441



KELLY LED
432-433



SPRAY 9
434-435



SPRAY 11
434-435



GRANADA SQ
434-435



PASADENA G53 R I
436-437



PASADENA G53 SQ I
436-437



PASADENA G53 SQ II
436-437



PASADENA GU10 SQ I
436-437



PASADENA GU10 SQ II
436-437



LIZARD I
438-439

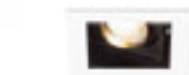

BONDY I
438-439



BONDY II
438-439



BONDY III
438-439



FIZZ III
440-441



MONE I
440-441



MONE II
440-441

MONE III
440-441

EMPOTRADO CIRCULAR



442-443

VIP
442-443

SOBER
442-443

TOPIC R
442-443



MIRO
442-443

REWA
442-443

EMPOTRADO ANGULAR



444-447

TECH I
444-445

LEDA
444-445

TIM
444-445



MERIKO GU10
446-447

TOPIC SQ
446-447

ACASA
446-447

ZURI SQ
446-447

MURO SQ
446-447

EMPOTRADO FINO



448-463

BJORK R 9
448-449

BJORK R 16
448-449

BJORK R 20
448-449



BJORK SQ 9
448-449



BJORK SQ 20
448-449



DADA 9
450-451



DADA 12
450-451



DADA 17
450-451



DADA 23
450-451



DADA 30
450-451



HUE R 9
452-453



HUE R 17
452-453



HUE R 22
452-453



HUE R 9
454-455



HUE R 17
454-455



HUE R 22
454-455



HUE SQ 9
456-457



HUE SQ 17
456-457



HUE SQ 22
456-457



HUE SQ 9
458-459

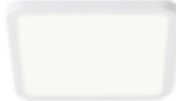

HUE SQ 17
458-459



HUE SQ 22
458-459



SOCORRO R 85
460-461



SOCORRO R 225
460-461



SLENDER SQ 8
460-461



PESANTE 90
462-463



STRUCTURAL LED 40x40
462-463

EMPOTRADO DE PARED

464-481



IRIA R
464-465



IRIA SQ
464-465



SEGNO
464-465



ELICA R
466-467



ELICA SQ
466-467



MEMPHIS R
466-467



MEMPHIS SQ
466-467



RIO SQ 0
468-469



RIO R
468-469



RIO SQ
468-469



CLUB IND
470-471



CLUB
470-471



MARCO
470-471



ASTERIA
470-471



KICK I
472-473



KICK II
472-473



KICK III
472-473



AMARO
474-475



TESS SQ
474-475



PER
474-475



INTRO L
476-477



RAGG
476-477



RASQ
476-477



GORDIQ S
478-479



GORDIQ M
478-479



GORDIQ L
478-479



DEJAVU SQ 9
480-481



DEJAVU SQ 14
480-481

SHARM

Sistema modular profesional SHARM LED ofrece hasta 2500 combinaciones para versiones de luminarias simples, dobles o triples. Módulos 5/10W, 3000/4000K, lentes con un ángulo de radiación de 12 ° y 24 °, dos tipos de difusores en 5 colores diferentes, anillo de adorno curvo o recto en 7 colores (opcional), bases redondeadas o iguales en 3 colores (opcional).

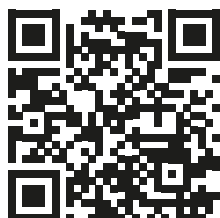

Con este código QR, puede acceder a nuestra página web donde se puede construir de manera cómoda y completa una luminaria según sus ideas. Usted tiene la capacidad de ensamblar más de 2500 variantes de esta luminaria.







SHARM

Luz fija empotrada con LED de 10W. Disponible en varios colores.

SHARM BASE EMPOTRADO

230 V LED 10 W $\angle 24^\circ$ 3000 K 900lm Ra 80

R13221	blanco	€ 48
R13222	oro perlado	€ 48
R13223	marrón	€ 48
R13224	negro	€ 48
R13225	chromo	€ 48
R13226	cobre	€ 48
R13227	chromo negro	€ 48

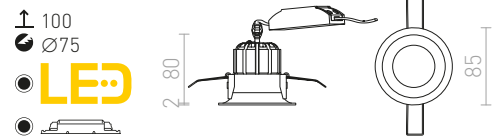

SHARM

Luz fija empotrada con LED de 10W. Disponible en varios colores.

SHARM PLUS EMPOTRADO

230 V LED 10 W $\angle 24^\circ$ 3000 K 900lm Ra 80

R13228	blanco	€ 48
R13229	oro perlado	€ 48
R13230	marrón	€ 48
R13231	negro	€ 48
R13232	chromo	€ 48
R13233	cobre	€ 48
R13234	chromo negro	€ 48

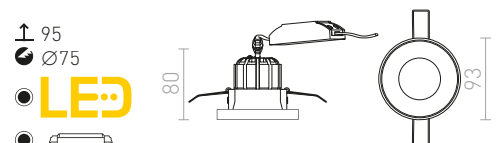



SHARM

Luz fija empotrada con LED de 10W. Mediante el uso del código QR usted puede visitar nuestra página web, donde podrá encontrar más de 2500 combinaciones de ensamblaje de acuerdo a su gusto.

SHARM R I EMPOTRADO

230 V LED 10 W $\angle 24^\circ$ 3000 K 900 lm Ra 80

R13235 blanco/cobre	€ 58
R13236 oro perlado/marrón	€ 58
R13237 marrón/oro perlado	€ 58
R13238 negro/cobre/cobre	€ 58
R13239 negro/negro/cobre	€ 58

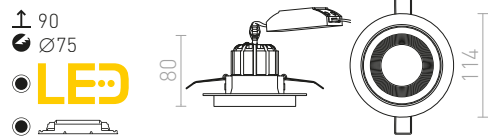

SHARM R II EMPOTRADO

230 V LED 2x10 W $\angle 24^\circ$ 3000 K 1800 lm Ra 80

R13240 blanco/cobre	€ 98
R13241 oro perlado/marrón	€ 98
R13242 marrón/oro perlado	€ 98
R13243 negro/cobre/cobre	€ 98
R13244 negro/negro/cobre	€ 98

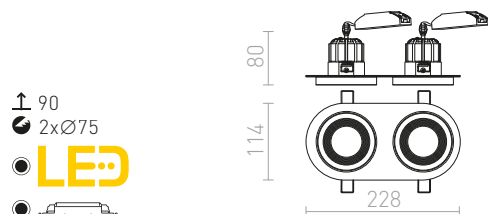



SHARM

Luz fija empotrada con LED de 10W. Mediante el uso del código QR usted puede visitar nuestra página web, donde podrá encontrar más de 2500 combinaciones de ensamblaje de acuerdo a su gusto.

SHARM R III EMPOTRADO

230 V LED 3x10 W $\angle 24^\circ$ 3000 K 2700 lm Ra 80

R13245 blanco/cobre € 138

R13246 oro perlado/marrón € 138

R13247 marrón/oro perlado € 138

R13248 negro/cobre/cobre € 138

R13249 negro/negro/cobre € 138

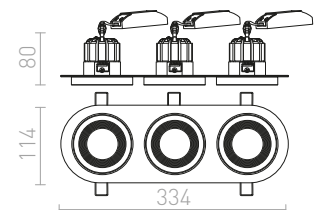
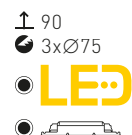
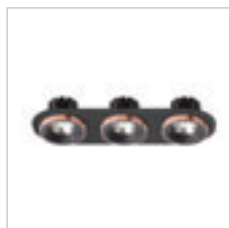
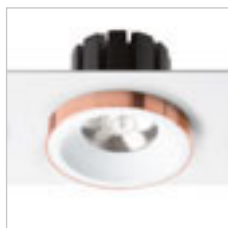



SHARM

Luz fija empotrada con LED de 10W. Mediante el uso del código QR usted puede visitar nuestra página web, donde podrá encontrar más de 2500 combinaciones de ensamblaje de acuerdo a su gusto.

SHARM SQ I EMPOTRADO

230 V LED 10 W $\angle 24^\circ$ 3000 K 900 lm Ra 80

R13250 blanco/cobre	€ 58
R13251 oro perlado/marrón	€ 58
R13252 marrón/oro perlado	€ 58
R13253 negro/cobre/cobre	€ 58
R13254 negro/negro/cobre	€ 58

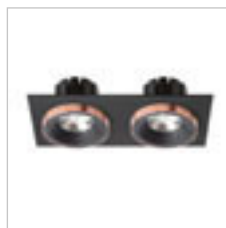
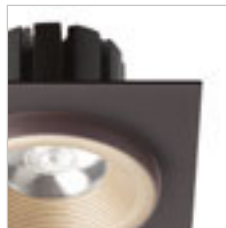
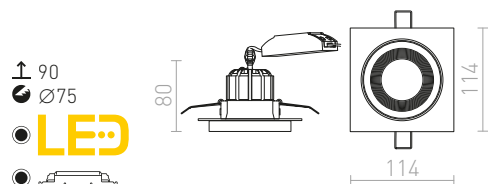

SHARM SQ II EMPOTRADO

230 V LED 2x10 W $\angle 24^\circ$ 3000 K 1800 lm Ra 80

R13255 blanco/cobre	€ 98
R13256 oro perlado/marrón	€ 98
R13257 marrón/oro perlado	€ 98
R13258 negro/cobre/cobre	€ 98
R13259 negro/negro/cobre	€ 98

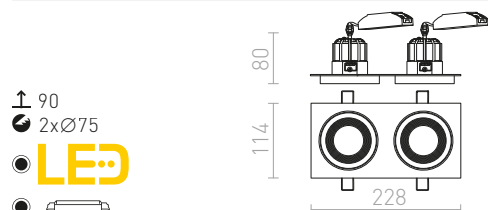



SHARM

Luz fija empotrada con LED de 10W. Mediante el uso del código QR usted puede visitar nuestra página web, donde podrá encontrar más de 2500 combinaciones de ensamblaje de acuerdo a su gusto.

SHARM SQ III EMPOTRADO

230 V LED 3x10 W $\angle 24^\circ$ 3000 K 2700 lm Ra 80

R13260 blanco/cobre	€ 138
R13261 oro perlado/marrón	€ 138
R13262 marrón/oro perlado	€ 138
R13263 negro/cobre/cobre	€ 150
R13264 negro/negro/cobre	€ 138

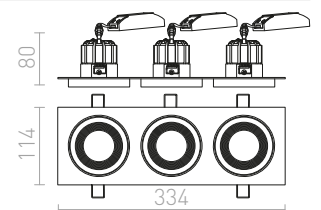
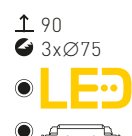



IP65



NAVY

Luminaria LED masiva para inserción en techos exteriores.

NAVY EMPOTRADA

230 V LED 15 W $\angle 36^\circ$ 2700 K 1100 lm Ra 80 IP65

R12661 blanco

€ 120 %

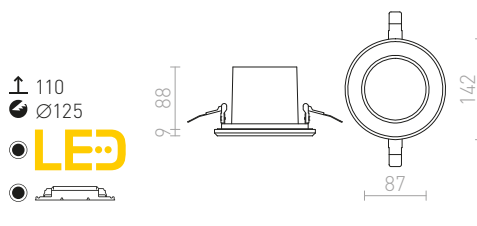

IP65



RINO

Luminaria empotrable de metal adecuada para ambientes húmedos con la posibilidad de reemplazar tapas frontales. La tapa debe pedirse por separado.

RINO EMPOTRADA SIN CUBIERTA

230 V LED 10 W $\angle 36^\circ$ 3000 K 760 lm Ra 80 IP65

R11682

€ 38 %

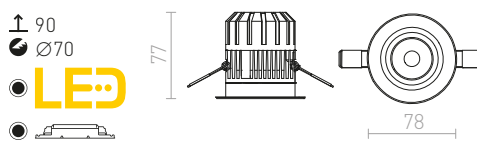

RINO

Tapa frontal para lámpara Rino.

RINO MARCO DECORATIVO

R11683 blanco

€ 9.35

R11684 cromo

€ 11.50 %

R11685 oro

€ 14.50 %

R11686 níquel mate

€ 11.50 %

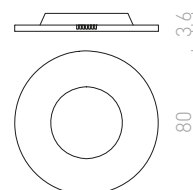



IP65

IP65



WATERBOY

Luz LED empotrada de aluminio adecuada en ambientes húmedos. Disponible en varias versiones.

WATERBOY SQ

230 V LED 10 W $\angle 40^\circ$ 3000 K 550 lm Ra 80 IP65

R11728 blanco mate € 78

R11729 níquel mate € 78

R11730 cromo € 78

R11741 negro mate € 78

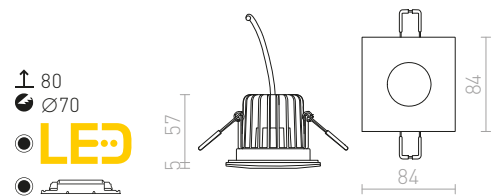

WATERBOY R

230 V LED 10 W $\angle 40^\circ$ 3000 K 550 lm Ra 80 IP65

R11725 blanco mate € 78

R11726 níquel mate € 78

R11727 cromo € 78

R11740 negro mate € 78

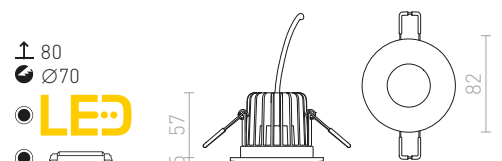



IP65



BELLA

Luminaria LED empotrable de baño para techos de cartón-yeso con reflector incorporado.

BELLA LED EMPOTRADO

230 V LED 11 W $\angle 40^\circ$ 3000 K 940 lm Ra 90 IP65

R13602 blanco

€ 68

↑ 70
● Ø68

● LED

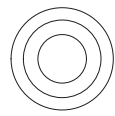
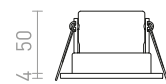

84



IP44



IP44



INEZ

Luminaria LED con baja profundidad de hueco. La luminaria también es adecuada para inserción en mobiliario.

INEZ R

12 V= LED 3 W 3000 K 170 lm Ra 80 IP44

R10586 cromo

€ 35

↑ 15
● Ø56

● LED

○ G14018

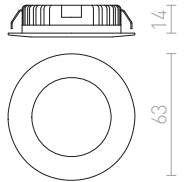

INEZ SQ

12 V= LED 3 W 3000 K 170 lm Ra 80 IP44

R10587 cromo

€ 19

↑ 15
● Ø56

● LED

○ G14018

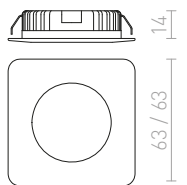

IP44



MERGO

Diodo LED empotrado con protección contra la humedad.

MERGO R EMPOTRADA

230 V LED 6,5 W 3000 K 535 lm Ra 80 IP44

R10572 cromo

€ 28

↑ 75
● Ø72

● LED

○ G14018

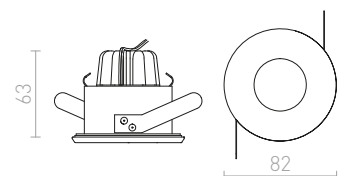



IP65



IP65



AMIGA

Luminaria LED de empotrar en metal con protección contra la humedad. TRIAC regulable.

AMIGA R DIMM

230 V LED 8 W $\angle 40^\circ$ 3000 K 580 lm Ra 80 IP65

R10565 blanco

€ 120

↑ 110
● Ø96

● LED

● regulable

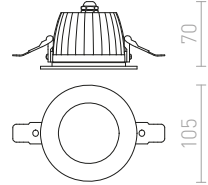

AMIGA SQ DIMM

230 V LED 8 W $\angle 40^\circ$ 3000 K 580 lm Ra 80 IP65

R10566 blanco

€ 120

↑ 110
● Ø96

● LED

● regulable

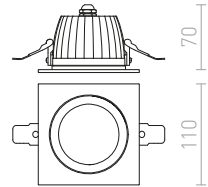

IP44



IP44



TOLEDO

Luminaria LED empotrable para techos de cartón yeso adecuada para el baño.

TOLEDO R

230 V LED 7 W $\angle 60^\circ$ 3000 K 514 lm Ra 80 IP44

R12716 blanco

€ 78

↑ 70
● Ø70

● LED

● regulable

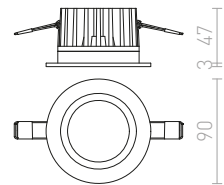

TOLEDO SQ

230 V LED 7 W $\angle 60^\circ$ 3000 K 513 lm Ra 80 IP44

R12717 blanco

€ 78

↑ 70
● Ø70

● LED

● regulable

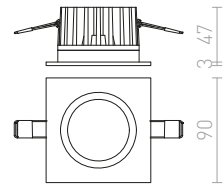



IP54

OWEN

Luminaria LED de empotrar regulable con control de color e intensidad luminosa - DIMM TO WARM. Gama de colores de luz 3000K - 1800K. Instalación en techo de cartón-yeso. Apto para ambientes húmedos. Atenuación TRIAC.

OWEN DIMM EMPOTRADO

230V LED 7W $\angle 45^\circ$ 3000 K - 1800 K 520 lm Ra 90 IP54

R13667 blanco

€ 78

R13668 negro

€ 78

↑ 110

● Ø55

● LED

● regulable



1800K → 3000K
DIMM TO WARM

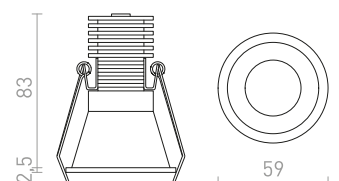





IP65



BELI

Luminaria empotrada sin marco. Difusor de luz acrílico esmerilado convexo. Apto para zonas húmedas.

BELI R 10 EMPOTRADO

230 V LED 6 W 3000 K 520 lm Ra 80 IP65

R13430 acrílico esmerilado

€ 29

↑ 40
● Ø80

● LED

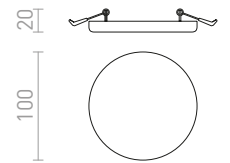

BELI R 21 EMPOTRADO

230 V LED 24 W 3000 K 2200 lm Ra 80 IP65

R13432 acrílico esmerilado

€ 68

↑ 40
● Ø195

● LED

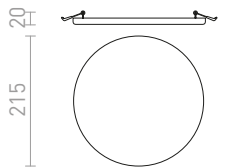

IP65



BELI

Luminaria empotrada sin marco. Difusor de luz acrílico esmerilado convexo. Apto para zonas húmedas.

BELI SQ 10 EMPOTRADO

230 V LED 6 W 3000 K 645 lm Ra 80 IP65

R13521 acrílico esmerilado

€ 32

↑ 40
■ 80x80

● LED

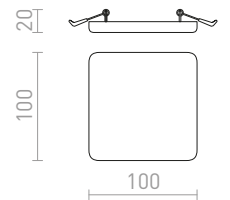

BELI SQ 21 EMPOTRADO

230 V LED 24 W 3000 K 2299 lm Ra 80 IP65

R13522 acrílico esmerilado

€ 78

↑ 40
■ 190x190

● LED

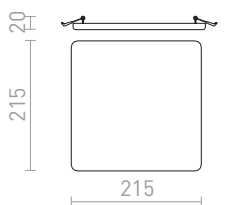



IP54



EQUA

Luminaria empotrada de baño redonda para fuentes de luz con conexión GU10. Solo para paneles de yeso.

EQUA

230 V GU10 35 W IP54

R12746 cromo

€ 11 %

↑ 100
● Ø75



G11841

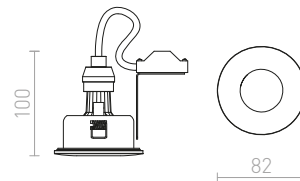

IP54



APRIORI

Luminaria redonda empotrada para los techos de cartón yeso, adecuada para baños, sobre lámpara reflectora con base GU10.

APRIORI

230 V GU10 35 W IP54

R12747 blanco/vidrio satinado

€ 22

↑ 140
● Ø75



G11841

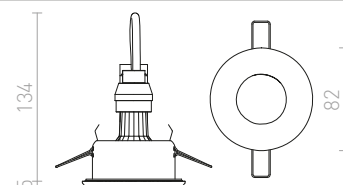

IP44



MAJESTIC

Luminaria empotrada para instalación en techos de cartón yeso, para la fuente de luz GU10, adecuada para entornos húmedos.

MAJESTIC

230 V GU10 35 W IP44

R12911 aluminio cepillado

€ 26 %

↑ 130
● Ø65



G11841

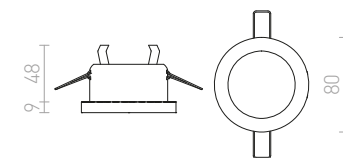



IP65



BERMUDA

Luminaria empotrada redonda para techos de cartón yeso, apta para baños, para la fuente de luz GU10.

BERMUDA EMPOTRADA

230 V GU10 35 W IP65

R12749 blanco

€ 22

R13604 negro

€ 22

↑ 150
● Ø75



G11841

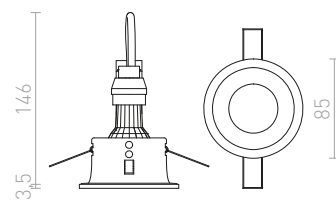



IP44



VERO

Luminaria empotrable con protección contra la humedad, adecuada para el baño. Con el centro de satén. Necesita agregar un transformador adecuado.

VERO EMPOTRADA
12V GU5,3 50W IP44

R10395/12 cromo

€ 38 %

↑ 110
● Ø95

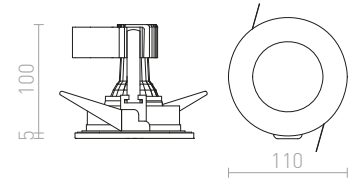

IP44



VERO

Luminaria empotrada con protección contra la humedad, adecuada para el baño. Con el centro de satén.

VERO EMPOTRADA
230V GU10 50W IP44

R10395 cromo

€ 38 %

↑ 110
● Ø95

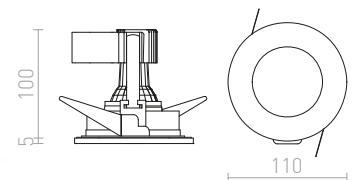



IP65



BELLA

Luminaria empotrable de baño para techos de cartón yeso con reflector incorporado, para bombillas LED con casquillo GU10.

BELLA GU10 EMPOTRADO

230 V LED GU10 15 W IP65

R13598 blanco	€ 24
R13599 negro	€ 24
R13600 cromo	€ 28
R13601 níquel mate	€ 28



↑ 140
● Ø68



G11841

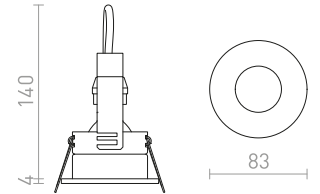

IP44

ACUA

Luminaria empotrable con protección contra la humedad adecuada para el baño. Vidrio satinado

ACUA EMPOTRADA

230 V GU10 50 W IP44

R10407 blanco	€ 18
----------------------	-------------



↑ 120
● Ø85



G11841

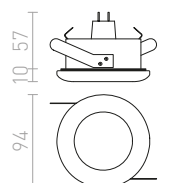



IP65



IP65

SPLASH

Luz empotrada de metal adecuada para los entornos húmedos. Disponible en cromo pulido y níquel satinado.

SPLASH R EMPOTRADA

230 V GU10 50 W IP65

R11733 cromo

€ 19

R11734 níquel mate

€ 18.50

120
Ø70



G11841

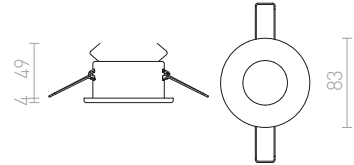

SPLASH SQ EMPOTRADA

230 V GU10 50 W IP65

R11735 cromo

€ 22

R11736 níquel mate

€ 22

120
Ø70



G11841

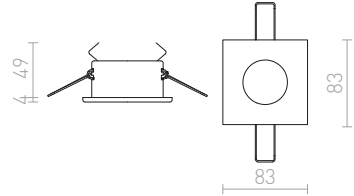

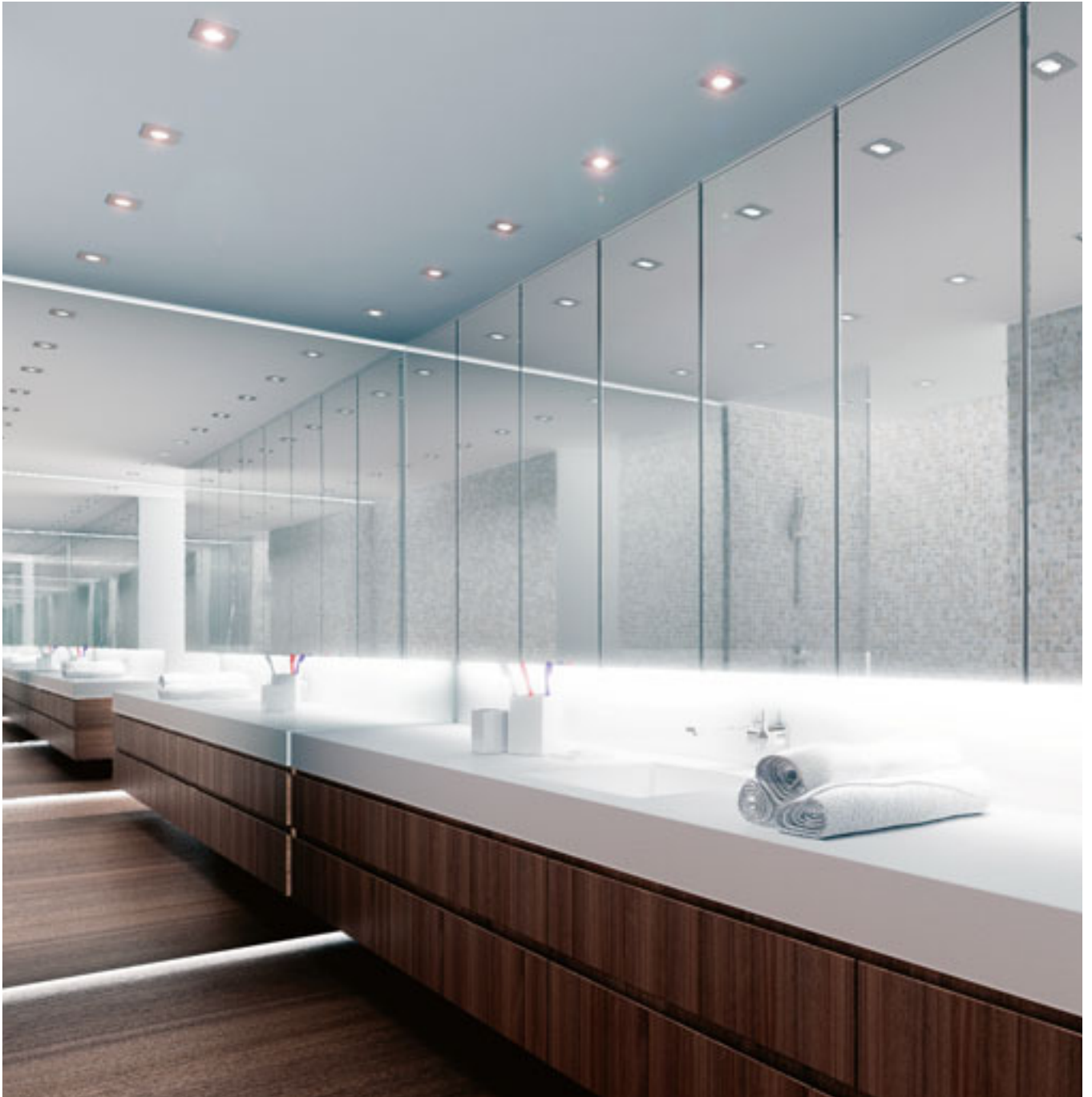

IP65



ASTOR

Atractiva luminaria con marco de aluminio peinado. La luminaria está cubierta con vidrio parcialmente satinado. Adecuado para ambientes húmedos.

ASTOR SQ

230 V GU10 50 W IP65

R10574 aluminio cepillado

€ 24

↑ 100
● Ø60



G11841

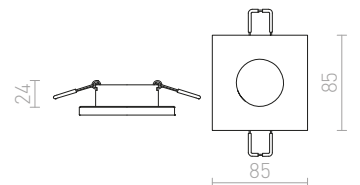



IP65



INCA

Accesorio de baño circular empotrado para montaje en techo de placas de yeso para lámparas LED con GU10.

INCA R

230 V GU10 7 W IP65

R12657 blanco

€ 29

↑ 150
● Ø70



G11841

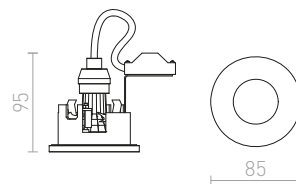

IP65

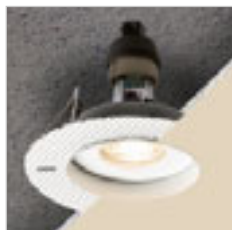

BRAN

Luminaria empotrable de baño para techos de cartón yeso en diseño sin marco, para bombillas LED con casquillo GU10.

BRAN EMPOTRADO

230 V LED GU10 15 W IP65

R13605 blanco

€ 28

↑ 140
● Ø80



G11841

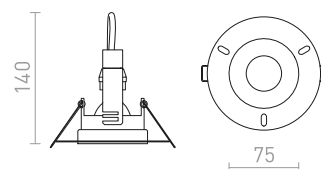

IP65



ISLA

Luminaria empotrable de baño para techos de pladur con reflector redondeado, para bombillas LED con casquillo GU10.

ISLA EMPOTRADO

230 V LED GU10 15 W IP65

R13603 blanco

€ 18

↑ 140
● Ø70



G11841

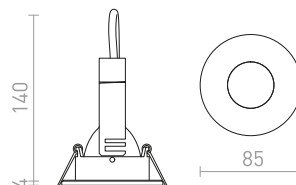



IP44

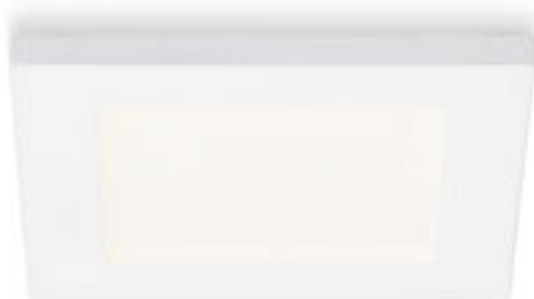

IP44



LEROY

Accesorio de baño empotrado para techos de cartón yeso. Para una bombilla de 12V con casquillo GU5,3.

LEROY R

12 V GU5,3 35 W IP44

R12659 blanco

€ 48

↑ 150
 ⦿ Ø80

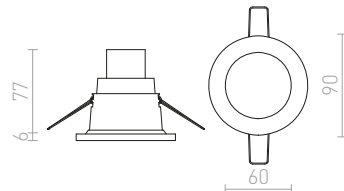
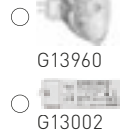

LEROY SQ

12 V GU5,3 35 W IP44

R12660 blanco

€ 48

↑ 150
 ⬜ 76x76

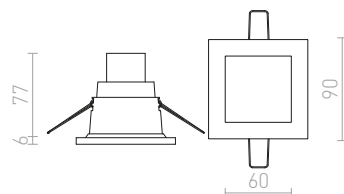
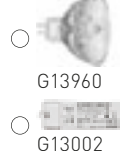





MARENGA

Lámpara LED empotrable para techo de cartón yeso con poca profundidad de empotramiento y pantalla decorativa. La sombra se crea mediante impresión 3D. Hecho de material PLA ecológico, que es totalmente degradable. El tamaño del orificio de montaje se puede ajustar utilizando los resortes de fijación deslizantes. Ppuede reemplazar convenientemente las lámparas halógenas existentes sin necesidad de modificar los orificios de montaje.

MARENGA RB1 40 EMPOTRADA

230 V LED 6 W 3000 K 570 lm Ra 80

R14011 blanco/Eco PLA

€ 68 **NEW**

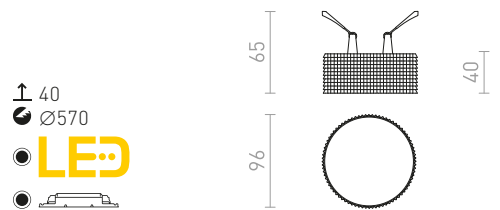

MARENGA SQB1 40 EMPOTRADA

230 V LED 6 W 3000 K 640 lm Ra 80

R14016 blanco/Eco PLA

€ 68 **NEW**

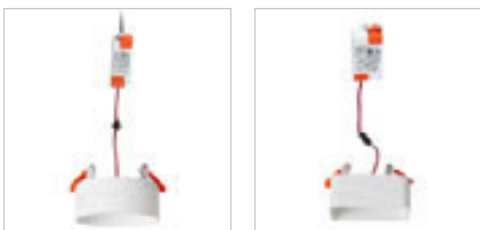
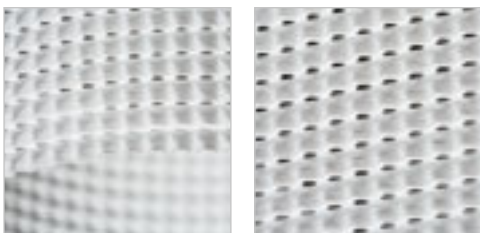
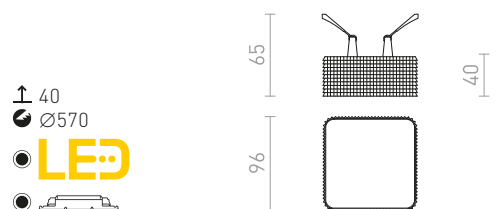



MARENGA

Lámpara LED empotrable para techo de cartón yeso con poca profundidad de empotramiento y pantalla decorativa. La sombra se crea mediante impresión 3D. Hecho de material PLA ecológico, que es totalmente degradable. El tamaño del orificio de montaje se puede ajustar utilizando los resortes de fijación deslizantes. Ppuede reemplazar convenientemente las lámparas halógenas existentes sin necesidad de modificar los orificios de montaje.

MARENGA RR1 40 EMPOTRADA

230 V LED 6 W 3000 K 570 lm Ra 80

R14002 blanco/Eco PLA

€ 68 NEW

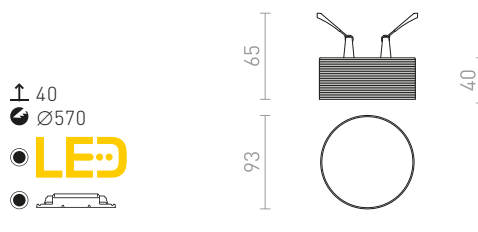

MARENGA RR3 60 EMPOTRADA

230 V LED 6 W 3000 K 570 lm Ra 80

R14003 blanco/Eco PLA

€ 78 NEW

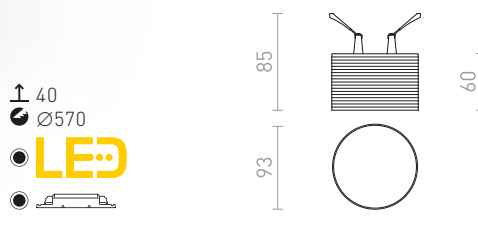

MARENGA RR4 90 EMPOTRADA

230 V LED 6 W 3000 K 570 lm Ra 80

R14004 blanco/Eco PLA

€ 78 NEW

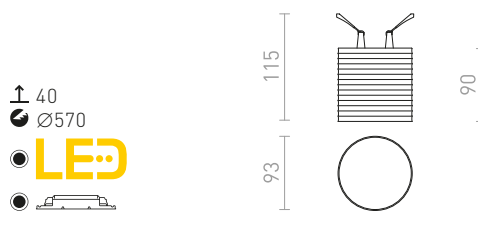

MARENGA SQR3 60 EMPOTRADA

230 V LED 6 W 3000 K 640 lm Ra 80

R14017 blanco/Eco PLA

€ 78 NEW

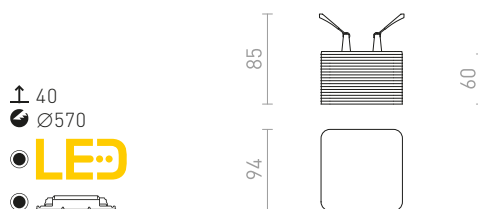







MARENGA

Lámpara LED empotrable para techo de cartón yeso con poca profundidad de empotramiento y pantalla decorativa. La sombra se crea mediante impresión 3D. Hecho de material PLA ecológico, que es totalmente degradable. El tamaño del orificio de montaje se puede ajustar utilizando los resortes de fijación deslizantes. Ppuede reemplazar convenientemente las lámparas halógenas existentes sin necesidad de modificar los orificios de montaje.

MARENGA RD4 52 EMPOTRADA

230 V LED 6 W 3000 K 570 lm Ra 80

R14007 blanco/Eco PLA

€ 78 **NEW**

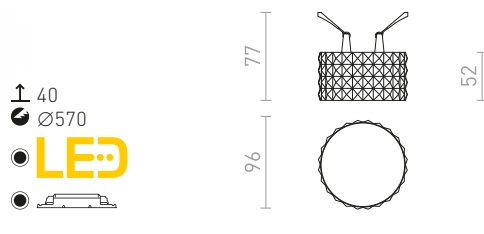

MARENGA RD3 60 EMPOTRADA

230 V LED 6 W 3000 K 570 lm Ra 80

R14008 blanco/Eco PLA

€ 78 **NEW**

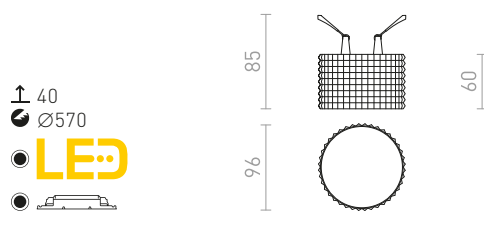

MARENGA RD1 73 EMPOTRADA

230 V LED 6 W 3000 K 570 lm Ra 80

R14009 blanco/Eco PLA

€ 78 **NEW**

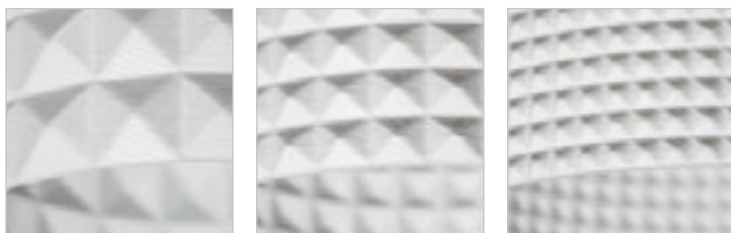
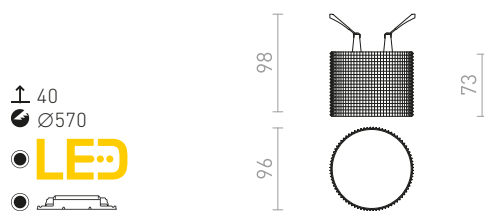

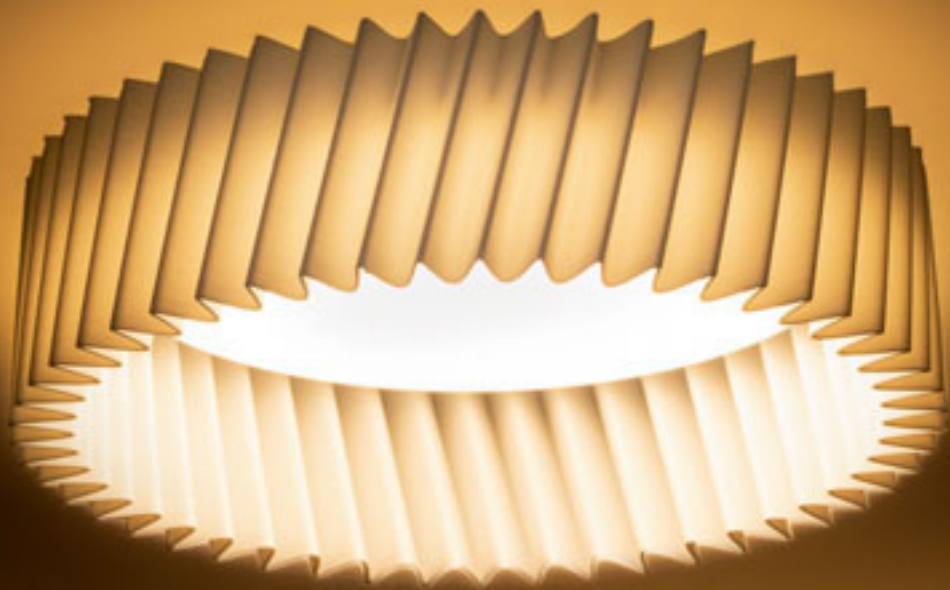



MARENGA

Lámpara LED empotrada para techo de cartón yeso con poca profundidad de empotramiento y pantalla decorativa. La sombra se crea mediante impresión 3D. Hecho de material PLA ecológico, que es totalmente degradable. El tamaño del orificio de montaje se puede ajustar utilizando los resortes de fijación deslizantes. Ppuede reemplazar convenientemente las lámparas halógenas existentes sin necesidad de modificar los orificios de montaje.

MARENGA RW1 30 EMPOTRADA

230 V LED 6 W 3000 K 570 lm Ra 80

R14013 blanco/Eco PLA

€ 68

NEW

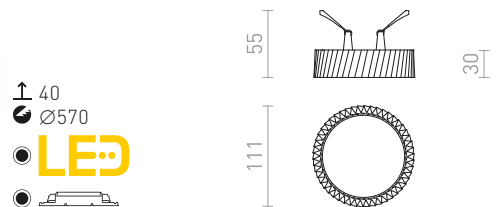

MARENGA RT1 40 EMPOTRADA

230 V LED 6 W 3000 K 570 lm Ra 80

R14012 blanco/Eco PLA

€ 68

NEW

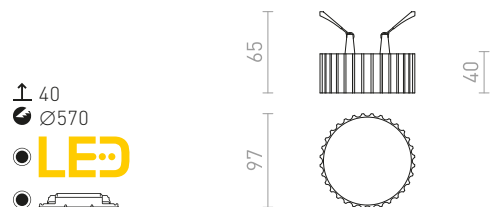

MARENGA RL1 40 EMPOTRADA

230 V LED 6 W 3000 K 570 lm Ra 80

R14005 blanco/Eco PLA

€ 68

NEW

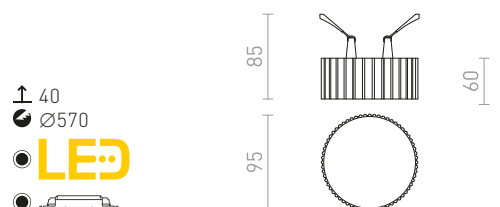

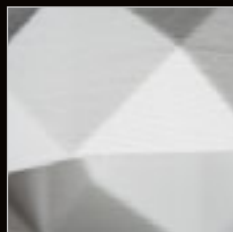



MARENGA

Lámpara LED empotrable para techo de cartón yeso con poca profundidad de empotramiento y pantalla decorativa. La sombra se crea mediante impresión 3D. Hecho de material PLA ecológico, que es totalmente degradable. El tamaño del orificio de montaje se puede ajustar utilizando los resortes de fijación deslizantes. Ppuede reemplazar convenientemente las lámparas halógenas existentes sin necesidad de modificar los orificios de montaje.

MARENGA RD5 28 EMPOTRADA

230 V LED 6 W 3000 K 570 lm Ra 80

R14006 blanco/Eco PLA

€ 58

NEW

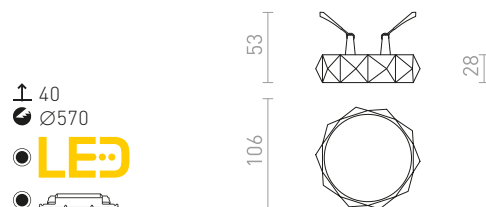

MARENGA RD6 96 EMPOTRADA

230 V LED 6 W 3000 K 570 lm Ra 80

R14010 blanco/Eco PLA

€ 78

NEW

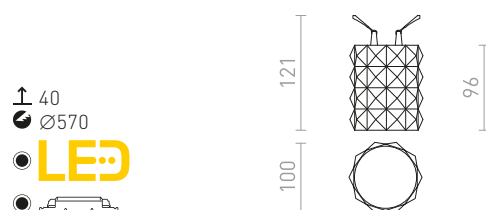

MARENGA RC1 98 EMPOTRADA

230 V LED 6 W 3000 K 570 lm Ra 80

R14015 blanco/Eco PLA

€ 78

NEW

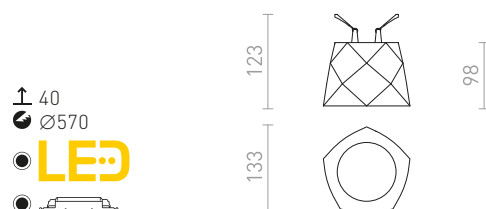

MARENGA RW2 60 EMPOTRADA

230 V LED 6 W 3000 K 570 lm Ra 80

R14014 blanco/Eco PLA

€ 78

NEW

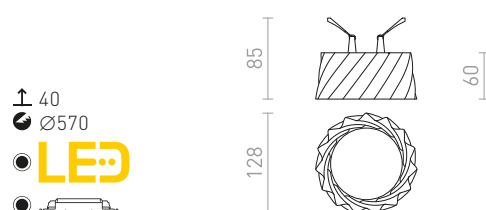





BIANCA

Luminaria empotrable de cristal satinado u opal.

BIANCA SQ EMPOTRADA

230 V GU10 50 W

R10304 vidrio opal

€ 28 %

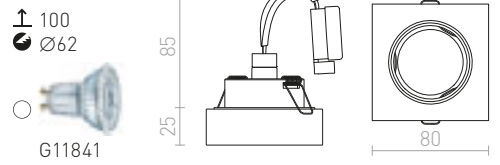

KAY

Luminaria empotrable con cubierta de vidrio satinado.

KAY R EMPOTRADA

230 V/350 mA LED 5 W 3000 K 450 lm Ra 80

R10419 vidrio satinado

€ 22 %

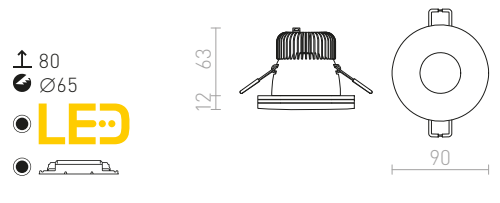

KAY SQ EMPOTRADA

230 V/350 mA LED 5 W 3000 K 450 lm Ra 80

R10418 vidrio satinado

€ 22 %

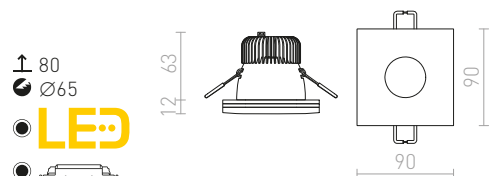



QUO

Lámpara de yeso con agujero redondo. Sin marco.
La luminaria se puede pintar con colores de interiores.
Instalación solo en placas de yeso.

QUO R II EMPOTRADA

230 V GU10 2x35 W

R12900 yeso

€ 48

↑ 160
↙ 80x150



G11841

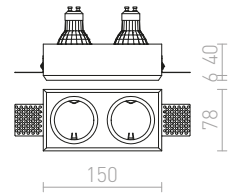

QUO R EMPOTRADA

230 V GU10 35 W

R12361 yeso

€ 22

↑ 150
↙ 80x80



G11841

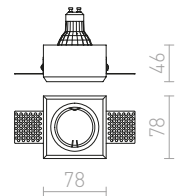

DAG

Luminaria empotrable de yeso. Sin marco. Instalación sólo en placas de yeso.

DAG R 83 EMPOTRADA

230 V GU10 35 W

R12357 yeso

€ 28

↑ 150
● Ø130



G11841

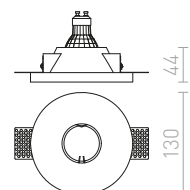



DANDY

Lámpara de yeso refractaria con acabado sin marco para fuentes de luz con GU10. Instalación sólo en placas de yeso.

DANDY R EMPOTRADA

230 V GU10 35 W

R12362 yeso

€ 18.50



↑ 150
● Ø100



G11841

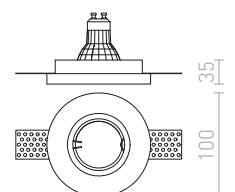



DAG

Luminaria empotrable de yeso. Sin marco. Instalación sólo en placas de yeso.

DAG SQ EMPOTRADA

230 V GU10 35 W

R12355 yeso

€ 24

↑ 150
120x120



G11841

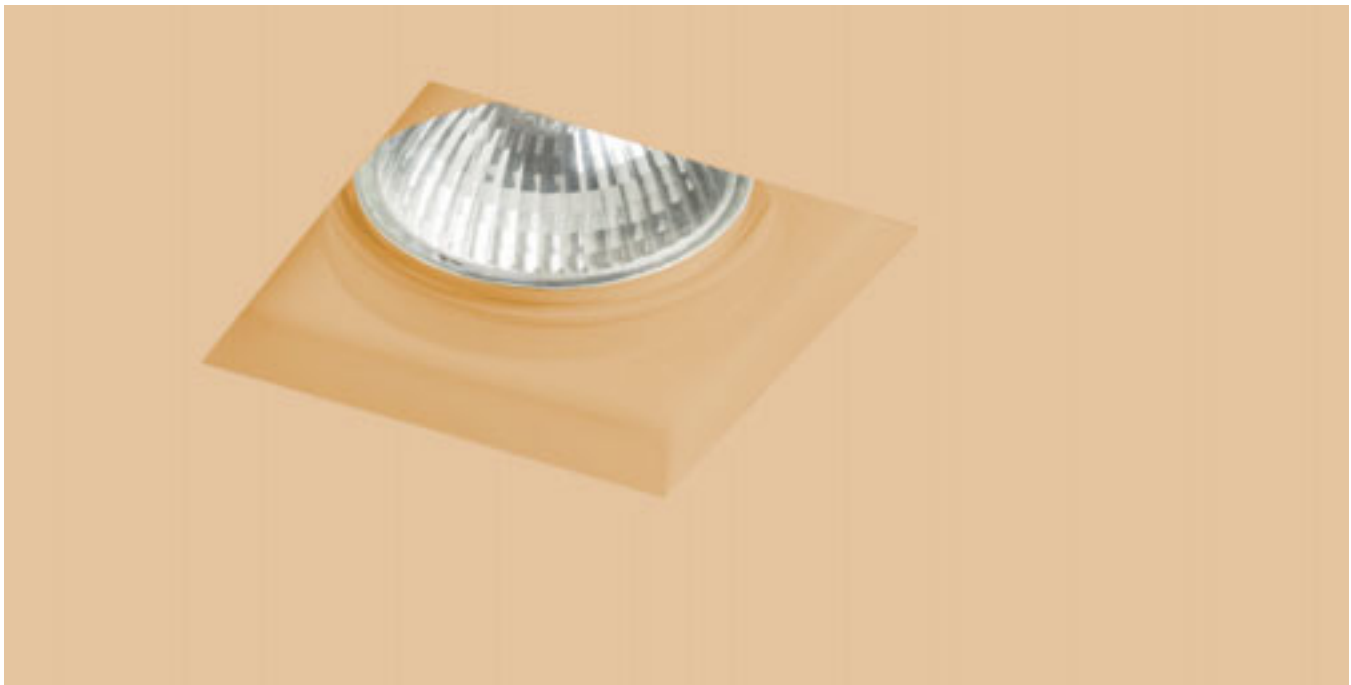
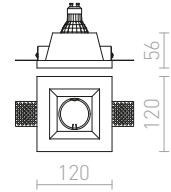

DANDY

Lámpara de yeso refractaria con acabado sin marco para fuentes de luz con GU10. Instalación sólo en placas de yeso.

DANDY SQ EMPOTRADA

230 V GU10 35 W

R12363 yeso

€ 18.50

↑ 150
100x100



G11841

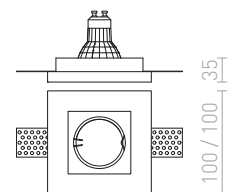



QUO

Lámparas de yeso con agujeros cuadrados. Sin marco. La luminaria se puede pintar con colores de interiores. Instalación sólo en placas de yeso.

QUO SQ I EMPOTRADA

230 V GU10 35 W

R12360 yeso

€ 22

↑ 150
80x80



G11841

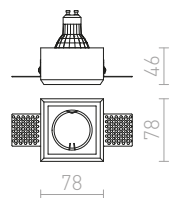

QUO SQ II EMPOTRADA

230 V GU10 2x35 W

R13126 yeso

€ 48

↑ 160
80x150



G11841

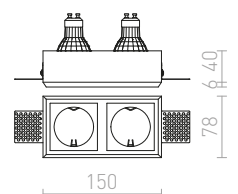





DINGO

Luminaria empotrada de yeso. Sin marco. Instalación sólo en cartón yeso. Se pueden colorear con pinturas para interiores.

DINGO S FIJO
230 V GU10 35 W

R12358 yeso

€ 24

↑ 150
120x120

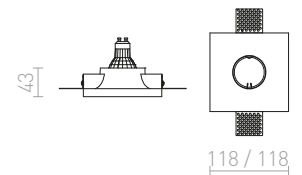

DINGO S INCLINABLE

12 V GU5,3 50 W

R10271 yeso

€ 68

↑ 150
Ø157

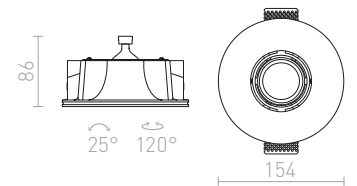

DINGO GU10 II INCLINABLE

230 V GU10 2x35 W

R12037 yeso

€ 120

↑ 150
257x157

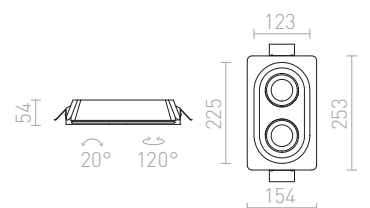



DINGO

Luminaria de yeso refractario con el agujero redondo. Sin marco. La superficie se puede pintar con pintura de interiores. Instalación solo en placas de yeso.

DINGO R INCLINABLE

12V G53 50W

R10269 yeso

€ 120

↑ 150

⊗ Ø232



G13656

G13002

96

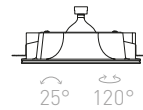

25° 120°

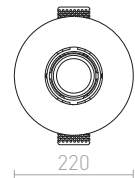

220



DINGO

Luminaria empotrada sin marco, de yeso y con apertura ovalada. La superficie se puede pintar con pintura de interiores. Únicamente para instalación en paneles de yeso.

DINGO II INCLINABLE

12V G53 2x50W

R10270 yeso

€ 138

↑ 150

⊗ 408x250



G13656

G13002

110

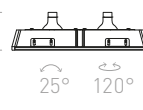

25° 120°

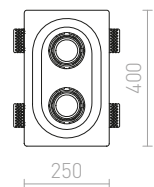

250







DINO SQUARE

Plafón sin marco en yeso con abertura cuadrada.
La superficie se puede pintar con pintura para pared de interiores. Instalación en paneles de yeso únicamente.

DINO SQ G53 INCLINABLE

12 V G53 50 W

R10272 yeso

€ 68 %

↑ 150

⚡ 252x252



G13656



G13002

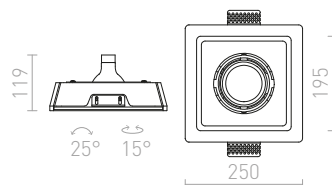

DINO SQ GU10 INCLINABLE

230 V GU10 35 W

R12038 yeso

€ 78

↑ 150

⚡ 157x157



G11841

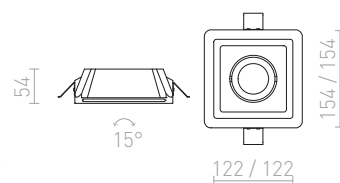

DAN SQ

Luminaria empotrada de yeso sin marco con cubierta de vidrio satinado. Instalación solo en techos de cartón yeso.

DAN SQ 80 EMPOTRADA

230 V GU10 35 W

R12356 yeso

€ 25

↑ 150

⚡ 120x120



G11841

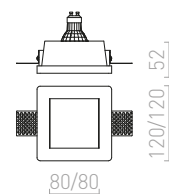



DINGO

Luminaria empotrable de yeso con reflector basculante para fuentes de luz con G5.3. Sin marco. Instalación solo en placas de yeso.

DINGO TUB EMPOTRADA

12 V GU5,3 35 W

R12359 yeso

€ 68



↑ 150
 170x170



G13705

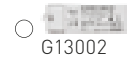

G13002

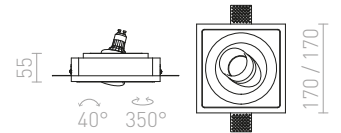

MIA

Luminaria refractaria de yeso con pantalla de policarbonato mate. Sin Marco. Instalación sólo en techos de cartón yeso.

MIA R EMPOTRADA

230 V E27 2x18 W

R10444 yeso/acrílico satinado

€ 158



↑ 180
 Ø260



G13155

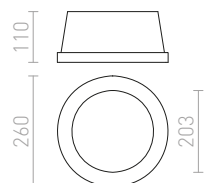



COIMBRA

Luminaria LED refractaria circular para instalar en techos de yeso con un soporte ajustable en altura.

COIMBRA EMPOTRADA

230 V LED 24 W 3000 K 1800 lm Ra 80

R12527 negro

€ 88 %

↑ 150
● Ø450

● LED

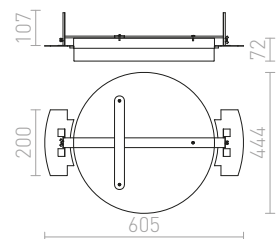



IPSO

Luz empotrada sin marco con la rosca GU10.

IPSO R FIJO

230 V GU10 35 W

R13288 blanco

€ 24

↑ 150

⊙ Ø85



G11841

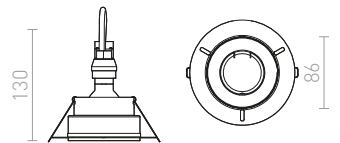

IPSO R FRAMELESS

230 V GU10 50 W

R12046 blanco

€ 48

↑ 140

⊙ Ø120



G11841

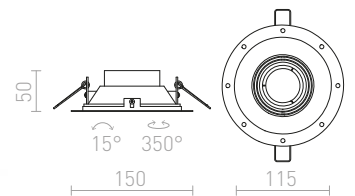

IPSO SQ FRAMELESS

230 V GU10 50 W

R12045 blanco

€ 48

↑ 140

⊞ 120x120



G11841

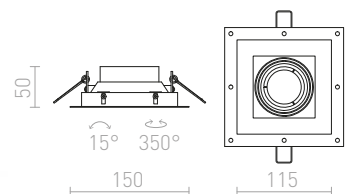



ELECTRA

Luz empotrada sin marco con fuentes de luz equipadas con cardán. La luz está equipada con tomas GU10.

ELECTRA I

230 V GU10 50 W

R12052 negro

€ 78

↑ 140
 108x108



G11841

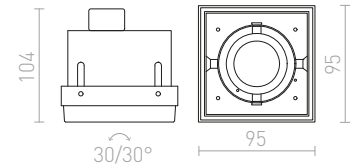

ELECTRA II

230 V GU10 2x50 W

R12053 negro

€ 129

↑ 140
 213x108



G11841

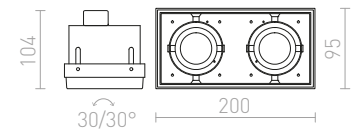



ELECTRA

Luminaria empotrable sin marco con fuente de luz cardanica. La luminaria está diseñada para fuentes de luz de 12V con G53. Suministrado sin transformador.

ELECTRA I
12 V G53 50 W

R12050 negro

€ 120



↑ 180
▣ 170x170



G13656



G13002

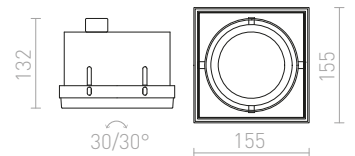



KELLY LED

Luz empotrada con una fuente de luz LED integrada y fija. Sólo para instalación en paneles de yeso. Atenuación TRIAC.

KELLY LED DIMM EMPOTRADA

230 V LED 15 W $\angle 45^\circ$ 3000 K 750 lm Ra 80

R12635 blanco

€ 98

R12636 negro

€ 98

↑ 60

● Ø120

● LED

● regulable

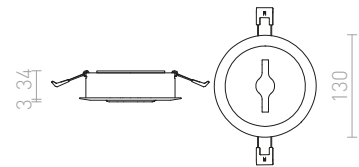

ZIZI

Luminaria empotrable en aluminio, pintada de blanco, inclinable para bombilla AR111.

ZIZI I EMPOTRADA

12 V G53 50 W

R12695 blanco

€ 35 %

↑ 160

● Ø160

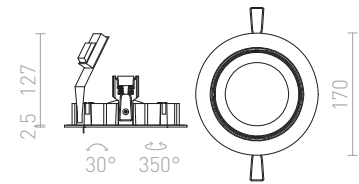

ZIZI II EMPOTRADA

12 V G53 50 W

R12696 blanco

€ 68 %

↑ 160

■ 320x160

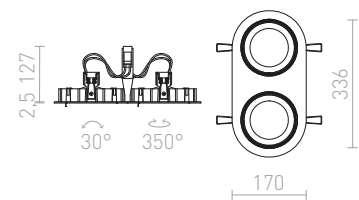



KELLY LED

Luminaria regulable semi empotrada con LED integrado y foco direccional. Sólo para instalación en techo de paneles de yeso. Atenuación TRIAC.

KELLY LED DIMM SEMI-EMPOTRADO

230 V LED 12 W $\angle 24^\circ$ 3000 K 600 lm Ra 80

R12637 blanco

€ 98

R12638 negro

€ 98

↑ 50

● Ø65

● LED

● regulable

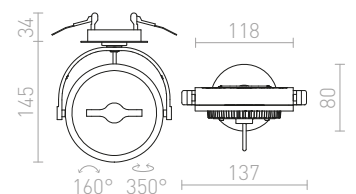



GRANADA

Luminaria empotrada de aluminio macizo lacado, inclinable. Para fuente de luz AR111.

GRANADA SQ

12V G53 50W

R12707 blanco

€ 32 %

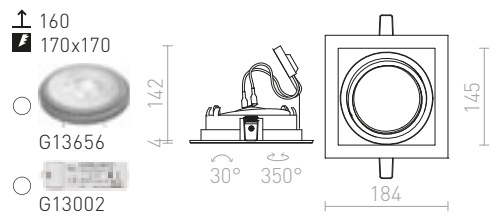

SPRAY

Lámpara empotrada con una fuente de luz LED fija, sólo para instalaciones en paneles de yeso.

SPRAY 11 EMPOTRADO

230V LED 9W $\angle 24^\circ$ 3000K 1250lm Ra90

R13302 negro

€ 18.50 %

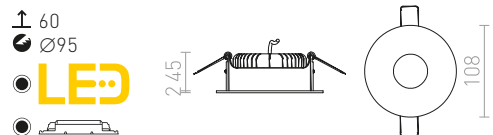

SPRAY 9 EMPOTRADO

230V LED 7W $\angle 24^\circ$ 3000K 880lm Ra90

R13300 negro

€ 14 %

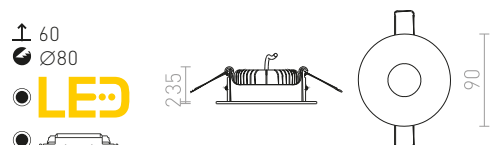





PASADENA

Luminaria empotrable con inclinación en aluminio con acabado natural o dos versiones barnizadas, para uso de bombillas GU10.

PASADENA GU10 SQ I EMPOTRADA

230 V GU10 50 W

R12709 aluminio cepillado

€ 22

R12710 blanco

€ 22

R12711 negro

€ 22

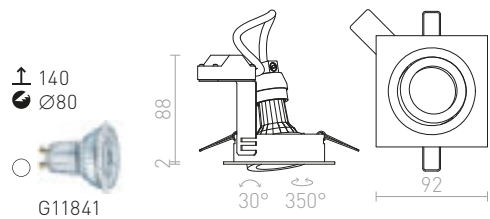

PASADENA GU10 SQ II EMPOTRADA

230 V GU10 2x50 W

R12712 aluminio cepillado

€ 29

R12713 blanco

€ 48

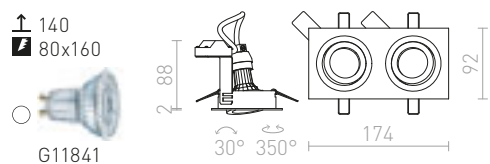



PASADENA

Luminaria redonda empotrada de aluminio con función de inclinación. Para fuentes de luz AR111.

PASADENA G53 R I

12 V G53 50 W

R12697 blanco

€ 58

R12699 negro

€ 58

↑ 140

⊙ Ø145



G13656



G13002

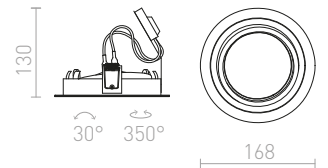

PASADENA

Luz empotrada con función de inclinación para fuentes de luz AR111.

PASADENA G53 SQ I

12 V G53 50 W

R12700 blanco

€ 58

R12702 negro

€ 48

↑ 150

⊙ Ø150



G13656



G13002

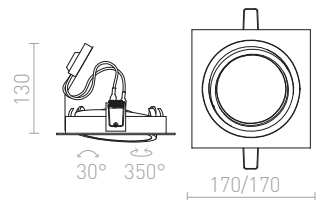

PASADENA G53 SQ II

12 V G53 2x50 W

R12703 blanco

€ 120

R12704 aluminio cepillado

€ 120

R12705 negro

€ 88

↑ 150

⊞ 315x150



G13656



G13002

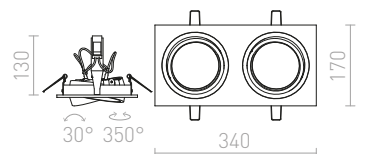



LIZARD

Mini luminaria LED empotrable para techos de cartón yeso.

LIZARD I EMPOTRADA

230 V LED 2 W $\angle 24^\circ$ 3000 K 128 lm Ra 80

R12854 blanco

€ 12 %

↑ 150
 35x35

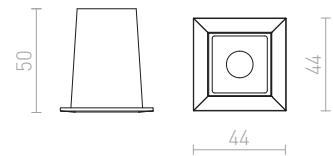

BONDY

Luminaria LED empotrable para techos de cartón yeso.

BONDY I EMPOTRADA

230 V LED 7 W $\angle 24^\circ$ 3000 K 560 lm Ra 80

R12856 blanco

€ 68

↑ 100
 90x90

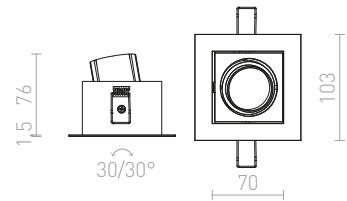

BONDY II EMPOTRADA

230 V LED 2x7 W $\angle 24^\circ$ 3000 K 1120 lm Ra 80

R12857 blanco

€ 88

↑ 100
 170x90

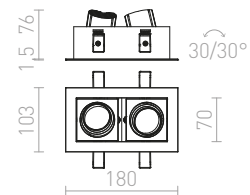

BONDY III EMPOTRADA

230 V LED 3x7 W $\angle 24^\circ$ 3000 K 1680 lm Ra 80

R12858 blanco

€ 88 %

↑ 100
 243x90

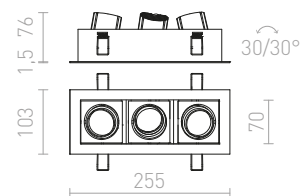





FIZZ

Luminaria empotrada con tomas cardán de fuentes, que permite la inclinación de fuentes de luz en todas las direcciones, marco de aluminio, uso exclusivo en placas de yeso.

FIZZ III INCLINABLE

12V GU5,3 3x50W

R10148 aluminio

€ 58 %

↑ 95
 241x88



G13705



G13002

45/30°

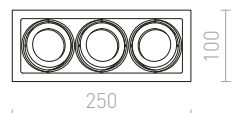



MONE

El ensamblaje de la luminaria permite que el reflector se pueda inclinar en la dirección de un eje. Tiene una estructura de aluminio laqueado. Sólo para la instalación en placas de yeso.

MONE I DIRECCIONAL

12 V GU5,3 50 W

R10204 blanco

€ 22 %

↑ 140

▣ 83x85



G13705



G13002

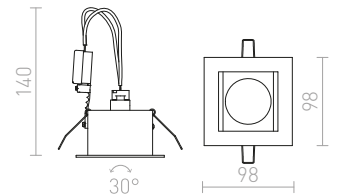

MONE II DIRECCIONAL

12 V GU5,3 2x50 W

R10217 gris plata

€ 29 %

↑ 140

▣ 145x85



G13705



G13002

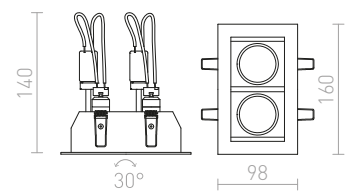

MONE III DIRECCIONAL

12 V GU5,3 3x50 W

R10218 gris plata

€ 32 %

↑ 140

▣ 215x85



G13705



G13002

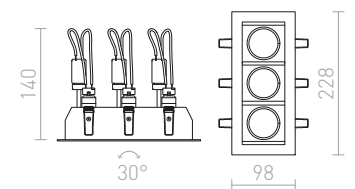



VIP

Luminaria giratoria de metal con diseño circular.

VIP DIRECCIONAL

230 V GU10 50 W

R11746 blanco mate

€ 16.50

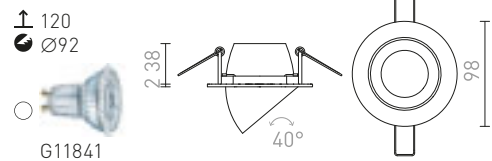

SOBER

Luminaria circular ligeramente inclinable con foco empotrado, metal lacado en blanco.

SOBER EMPOTRADA

230 V GU10 50 W

R11738 blanco

€ 24

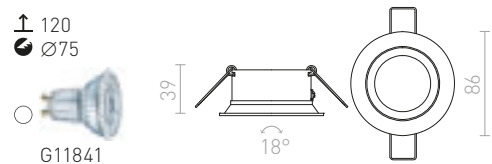



TOPIC

Luz de metal direccional cuadrada, disponible en cromo brillante, níquel mate y blanco lacado.

TOPIC R INCLINABLE

230 V GU10 50 W

R11731 níquel mate

€ 6 %

R11742 cromo

€ 5.80 %

R11743 blanco mate

€ 10.50

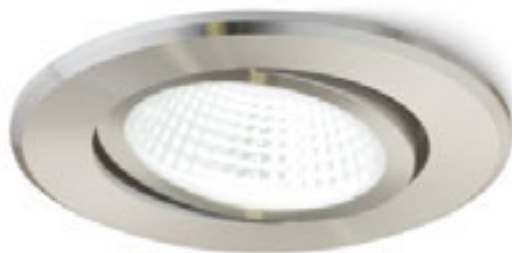
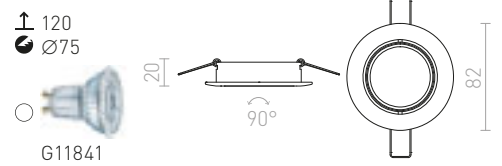

MIRO

Luminaria empotrada basculante con LED de 3W. Transformador incluido.

MIRO EMPOTRADA

230 V/350 mA LED 3 W 3000 K 270 lm Ra 80

R10420 acero inoxidable

€ 19.50 %

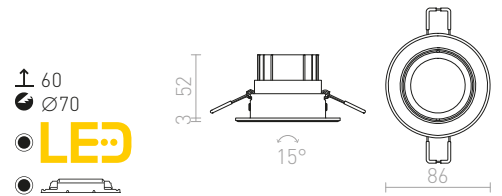

REWA

Foco empotrado con marco sólido y texturado.

REWA FIJO

230 V GU10 50 W

R10421 cromo

€ 19 ➔

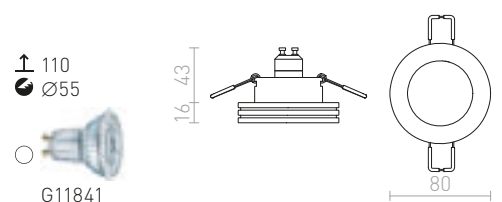





TECH I

Luminaria empotrable no inclinable con LED de 5.4W cubierta con vidrio transparente.

TECH I FIJO

230 V LED 5,4 W $\angle 40^\circ$ 3000 K 340 lm Ra 80

R10404 blanco

€ 25

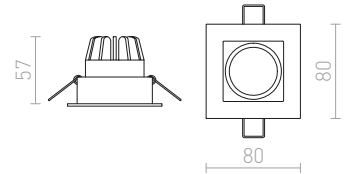
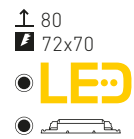

LEDA

Luminaria de empotrar con montaje cardán de fuente de luz LED.

LEDA EMPOTRADA

230 V/350 mA LED 5,4 W $\angle 25^\circ$ 3000 K 340 lm Ra 80

R10402 blanco

€ 48

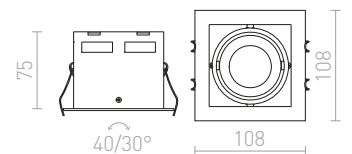
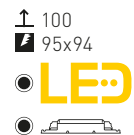

TIM

Luminaria empotrable de inclinación. Se suministra incluyendo el transformador.

TIM EMPOTRADA

230 V LED 10 W 3000 K 750 lm Ra 80

R12009 blanco

€ 58

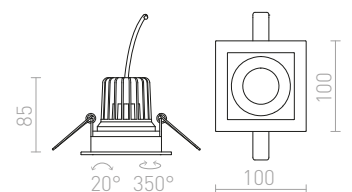
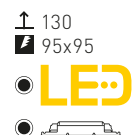



TOPIC

Luz de metal direccional cuadrada, disponible en cromo brillante, níquel mate y blanco lacado.

TOPIC SQ INCLINABLE

230 V GU10 50 W

R11732 níquel mate

€ 5.35 %

R11744 cromo

€ 5.35 %

R11745 blanco mate

€ 9.20

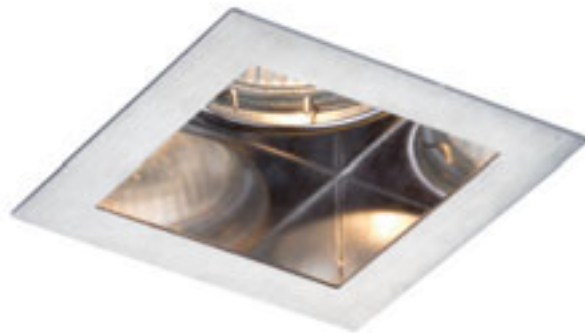
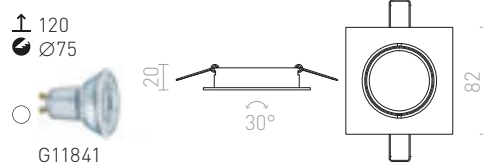

MERIKO

Estructura de acero inoxidable, fuente de luz fija sin posibilidad de inclinación, usar sólo en placas de yeso.

MERIKO GU10 FIJO

230 V GU10 50 W

R10219 acero inoxidable

€ 18.50 %

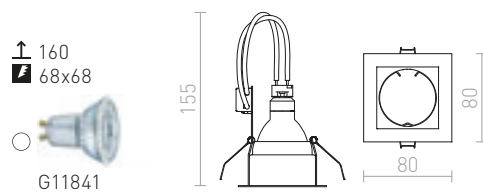

ZURI

Foco empotrable cuadrado con casquillo fijo GU10.

ZURI SQ EMPOTRADO

230 V GU10 35 W

R13391 negro

€ 10.50 %

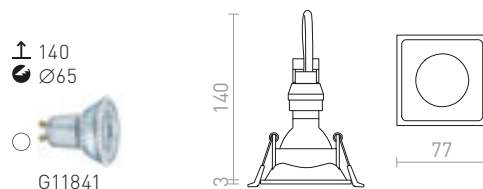



MURO

Luminaria empotrable cuadrada para montaje en techos de placas de yeso con lámpara base GU10.

MURO SQ EMPOTRADA

230 V GU10 50 W

R12748 níquel mate

€ 9.20

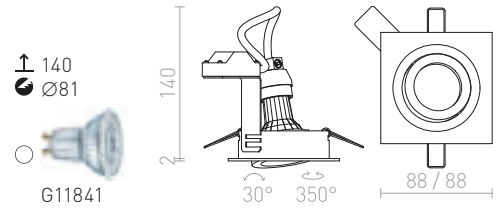

ACASA

Luminaria de empotrar cuadrada para montaje en techos de pladur con posibilidad de inclinar sobre bombilla con casquillo GU10.

ACASA EMPOTRADA

230 V GU10 50 W

R12750 blanco

€ 24

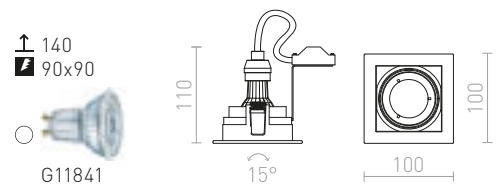

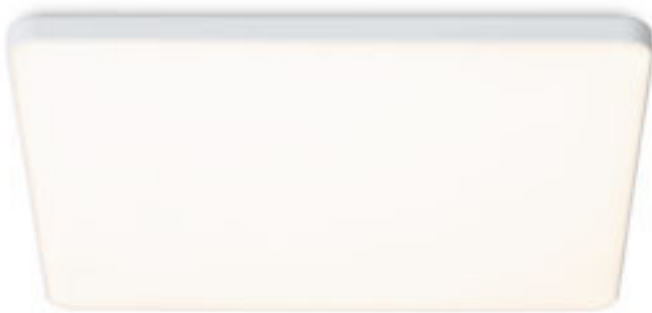

BJORK

Luminaria LED de empotrar para techo de cartón-yeso con poca profundidad de empotramiento y marco de diseño. Adecuado para combinar con la gama de luminarias de superficie Larisa. El tamaño del orificio de montaje se puede seleccionar utilizando los resortes de sujeción deslizantes. Las luminarias se pueden sustituir cómodamente por luminarias halógenas existentes, sin necesidad de modificar los orificios de montaje.

BJORK SQ 9 EMPOTRADO

230 V LED 6 W 3000 K 640 lm Ra 80

R13588 blanco

€ 26

R13589 negro

€ 26

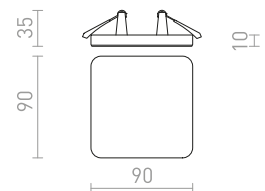

BJORK SQ 20 EMPOTRADO

230 V LED 18 W 3000 K 1800 lm Ra 80

R13590 blanco

€ 58

R13591 negro

€ 58

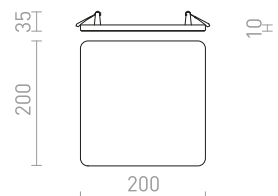
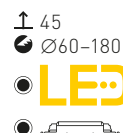



BJORK

Luminaria LED de empotrar para techo de cartón-yeso con poca profundidad de empotramiento y marco de diseño. Adecuado para combinar con la gama de luminarias de superficie Larisa. El tamaño del orificio de montaje se puede seleccionar utilizando los resortes de sujeción deslizantes. Las luminarias se pueden sustituir cómodamente por luminarias halógenas existentes, sin necesidad de modificar los orificios de montaje.

BJORK R 9 EMPOTRADO

230 V LED 6 W 3000 K 570 lm Ra 80

R13582 blanco

€ 24

R13583 negro

€ 24

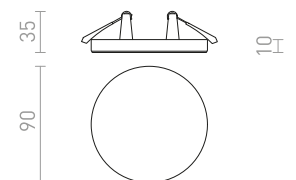
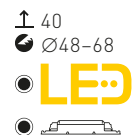

BJORK R 16 EMPOTRADO

230 V LED 12 W 3000 K 1200 lm Ra 80

R13584 blanco

€ 38

R13585 negro

€ 38

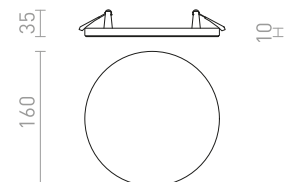
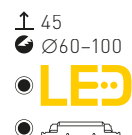

BJORK R 20 EMPOTRADO

230 V LED 18 W 3000 K 1800 lm Ra 80

R13586 blanco

€ 58

R13587 negro

€ 58

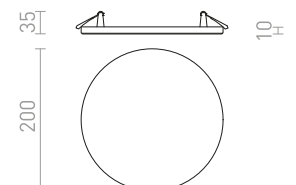
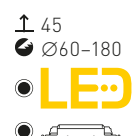



DADA

Luminaria LED empotrable circular para techos de cartón yeso con marco redondeado y profundidad de hueco reducida.

DADA 9 EMPOTRADA

230 V LED 3 W 3000 K 180 lm Ra 80

R12870 cromo negro

€ 9.35 %

↑ 60
● Ø75

● LED

● [mounting icon]

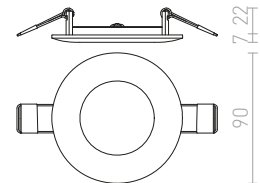

DADA 12 EMPOTRADA

230 V LED 6 W 3000 K 360 lm Ra 80

R12871 blanco

€ 13.50 %

R12872 cromo

€ 15 %

R12875 cromo negro

€ 15 %

↑ 60
● Ø110

● LED

● [mounting icon]
● regulación
opcional

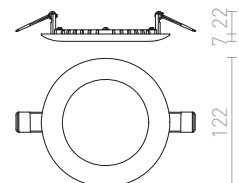



DADA

Luminaria LED empotrable circular para techos de cartón yeso con marco redondeado y profundidad de hueco reducida.

DADA 17 EMPOTRADA

230 V LED 12 W 3000 K 720 lm Ra 80

R12876 blanco € 19 %

R12877 cromo € 22 %

R12880 cromo negro € 15.50 %

- ↑ 60
- ⊗ Ø160
- LED
- regulación opcional

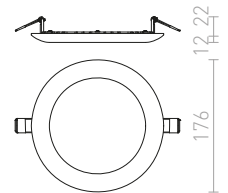

DADA 23 EMPOTRADA

230 V LED 18 W 3000 K 1080 lm Ra 80

R12881 blanco € 26 %

R12882 cromo € 13.50 %

R12884 cobre € 24 %

R12885 cromo negro € 28 %

- ↑ 100
- ⊗ Ø210
- LED
- regulación opcional

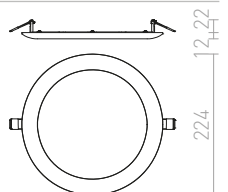

DADA 30 EMPOTRADA

230 V LED 24 W 3000 K 1440 lm Ra 80

R12886 blanco € 38 %

R12887 cromo € 26 %

R12888 oro € 32 %

R12889 cobre € 32 %

R12890 cromo negro € 26 %

- ↑ 100
- ⊗ Ø280
- LED
- regulación opcional

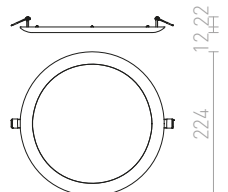



HUE

Luminaria empotrada muy delgada para LED integrado de alto rendimiento. El marco está disponible en cromo, cromo negro, níquel mate, lacado blanco e imitación de madera.

HUE R 9 EMPOTRADA

230 V LED 6 W 3000 K 540 lm Ra 80

R12760 blanco	€ 22	→
R12761 cromo negro	€ 15.50	%
R12763 níquel mate	€ 15.50	%
R12764 decoración de haya	€ 22	→

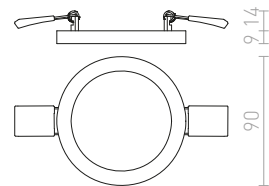
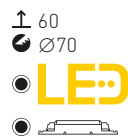

HUE R 17 EMPOTRADA

230 V LED 18 W 3000 K 1620 lm Ra 80

R12765 blanco	€ 48	→
R12766 cromo negro	€ 24	%
R12767 cromo	€ 48	%
R12768 níquel mate	€ 35	%
R13401 imitación de nogal oscuro	€ 35	%

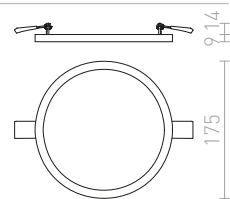
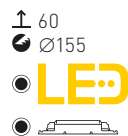

HUE R 22 EMPOTRADA

230 V LED 24 W 3000 K 2160 lm Ra 80

R12770 blanco	€ 68	→
R12771 cromo negro	€ 48	%
R12772 cromo	€ 48	%
R12773 níquel mate	€ 48	%
R12774 decoración de haya	€ 68	→
R13402 imitación de nogal oscuro	€ 68	%

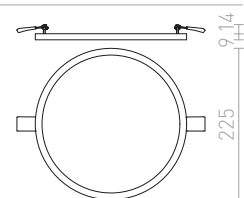
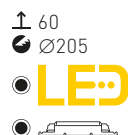







HUE

Luminaria empotrada muy delgada con LED regulable de alto rendimiento integrado. Los marcos de luz son cromo, cromo negro, níquel mate, lacado blanco e imitación de madera. Regulable TRIAC.

HUE R 9 DIMM EMPOTRADA

230 V LED 6 W 3000 K 540 lm

R13127 blanco	€ 58
R13128 cromo negro	€ 48
R13130 níquel mate	€ 48
R13131 decoración de haya	€ 58

- ↑ 60
- Ø70
- **LED**
- regulable

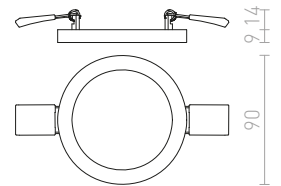

HUE R 17 DIMM EMPOTRADA

230 V LED 18 W 3000 K 1620 lm Ra 80

R13053 blanco	€ 120
R13054 cromo negro	€ 88
R13055 cromo	€ 98
R13056 níquel mate	€ 98
R13441 imitación de nogal oscuro	€ 98

- ↑ 60
- Ø155
- **LED**
- regulable

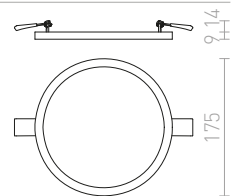

HUE R 22 DIMM EMPOTRADA

230 V LED 24 W 3000 K 2160 lm Ra 80

R13058 blanco	€ 129
R13059 cromo negro	€ 120
R13060 cromo	€ 120
R13061 níquel mate	€ 120
R13062 decoración de haya	€ 120
R13442 imitación de nogal oscuro	€ 120

- ↑ 60
- Ø205
- **LED**
- regulable

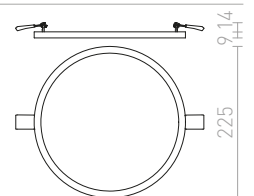

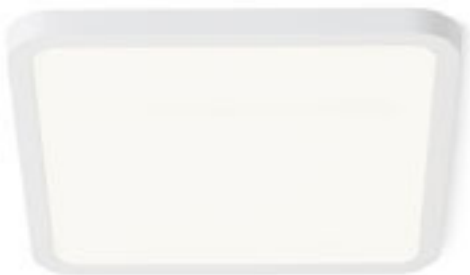

HUE

Luminaria empotrada muy delgada para LED integrado de alto rendimiento. El marco está disponible en cromo, cromo negro, níquel mate, lacado blanco e imitación de madera.

HUE SQ 9 EMPOTRADA

230 V LED 6 W 3000 K 540 lm Ra 80

R12775 blanco	€ 19	→
R12776 cromo negro	€ 16	%
R12777 cromo	€ 18	%
R12778 níquel mate	€ 16	%

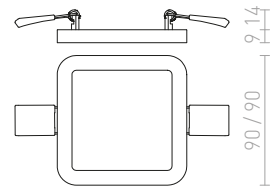
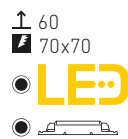

HUE SQ 17 EMPOTRADA

230 V LED 18 W 3000 K 1620 lm Ra 80

R12780 blanco	€ 38	%
R12781 cromo negro	€ 32	%
R12782 cromo	€ 32	%
R12783 níquel mate	€ 32	%
R12784 decoración de haya	€ 35	%

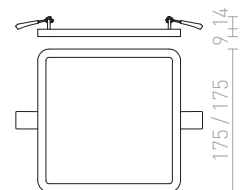
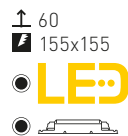

HUE SQ 22 EMPOTRADA

230 V LED 24 W 3000 K 2160 lm Ra 80

R12785 blanco	€ 58	%
R12786 cromo negro	€ 48	%
R12787 cromo	€ 38	%
R12788 níquel mate	€ 38	%
R12789 decoración de haya	€ 38	%

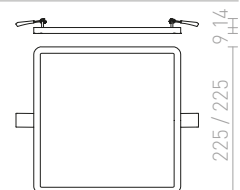
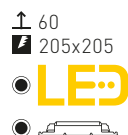





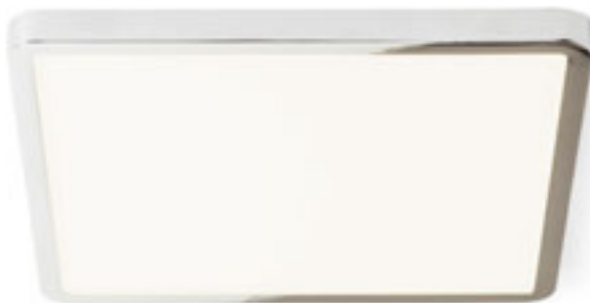

HUE

Luminaria empotrada muy delgada con LED regulable de alto rendimiento integrado. Los marcos de luz son cromo, cromo negro, níquel mate, lacado blanco e imitación de madera. Atenuación TRIAC.

HUE SQ 9 DIMM EMPOTRADA

230 V LED 6 W 3000 K 540 lm Ra 80

R13132 blanco	€ 58
R13133 cromo negro	€ 48
R13134 cromo	€ 58
R13135 níquel mate	€ 58

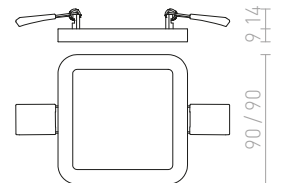
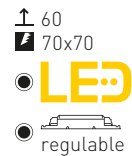

HUE SQ 17 DIMM EMPOTRADA

230 V LED 18 W 3000 K 1620 lm Ra 80

R13063 blanco	€ 120
R13064 cromo negro	€ 98
R13065 cromo	€ 98
R13066 níquel mate	€ 98
R13067 decoración de haya	€ 98

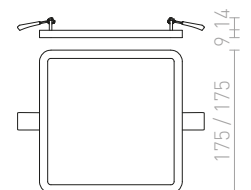
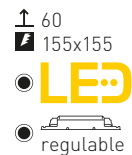

HUE SQ 22 DIMM EMPOTRADA

230 V LED 24 W 3000 K 2160 lm Ra 80

R13068 blanco	€ 120
R13069 cromo negro	€ 120
R13070 cromo	€ 120
R13071 níquel mate	€ 120
R13072 decoración de haya	€ 120

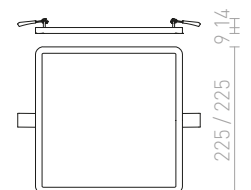
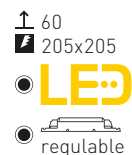



SLENDER

Plafón empotrado muy fino con LED integrado de alto rendimiento. Regulador incluido.

SLENDER SQ 8 EMPOTRADA

230 V LED 3W 3000 K 300 lm Ra 80

R12186 cromo negro

€ 7.20 %

R12187 cromo

€ 7.35 %

↑ 50
65x65

LED

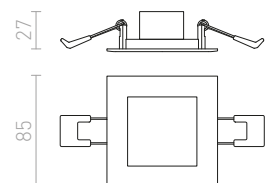



SORCORRO

Plafón muy fino para LED de alto rendimiento. Marco lacado en blanco de aluminio fundido a presión. Regulador incluido.

SORCORRO R 85 EMPOTRADA

230 V LED 3 W 3000 K 240 lm Ra 80

R12963 blanco

€ 11

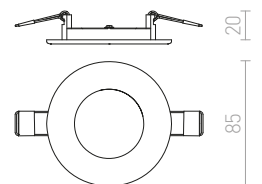
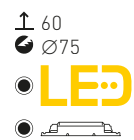

SORCORRO R 225 EMPOTRADA

230 V LED 18 W 3000 K 1440 lm Ra 80

R12965 blanco

€ 32

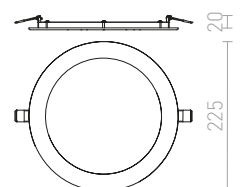



PESANTE

Luminaria empotrada de LED lineal para techos de yeso. Adecuada para interiores modernos.

PESANTE 90 EMPOTRADA

230 V LED 40 W 3000 K 4200 lm Ra 80

R12722 blanco

€ 215

↑ 80

■ 1200x76

● LED

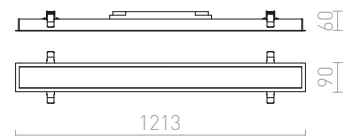



STRUCTURAL

Lámpara empotrada con marco lacado y LED integrado. Driver incluido.

STRUCTURAL LED 40x40 EMPOTRADA

230V LED 40W 3000K 2918lm Ra80

R12062 blanco

€ 178

↑ 60

■ 395x395

● LED

● regulación
opcional

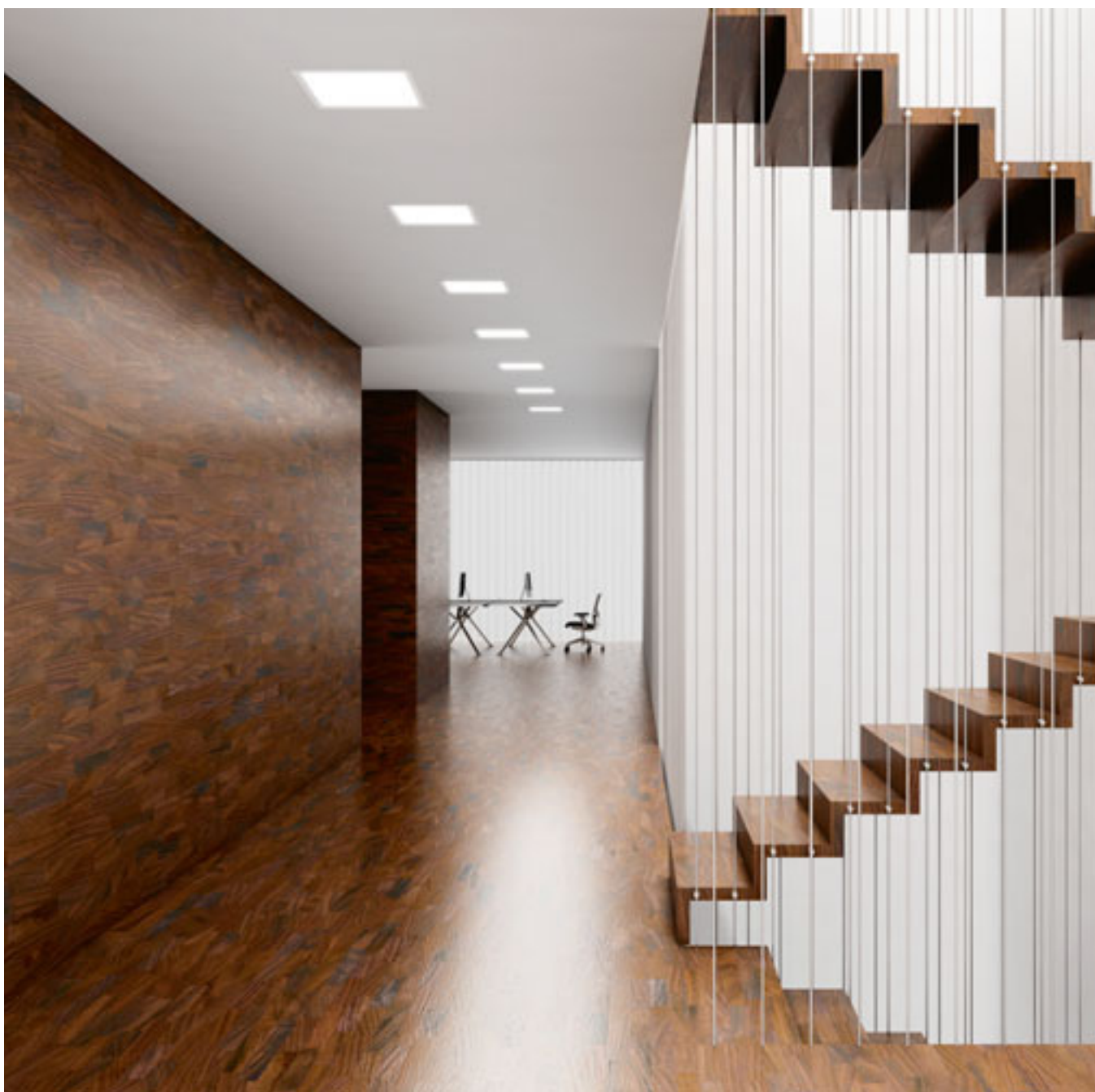
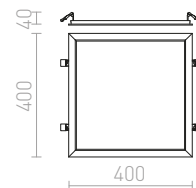





IRIA

Aplique de pared LED empotrado con ranura para haz de luz estrecho.

IRIA R EMPOTRADA

230 V LED 3 W $\angle 10^\circ$ 3000 K 390 lm Ra80

R12611 blanco

€ 58

↑ 120
⚡ Ø45



LED

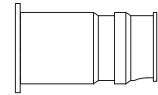

87



55

IRIA SQ EMPOTRADA

230 V LED 3 W $\angle 10^\circ$ 3000 K 390 lm Ra80

R12612 blanco

€ 58

↑ 120
⚡ Ø45



LED

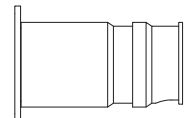

84

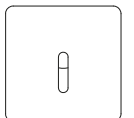

60



IP54

SEGNO

Luminaria LED exterior empotrable en pared con una emisión decente a través de una rendija estrecha.

SEGNO EMPOTRADO

230 V LED 3 W 3000 K Ra80 IP54

R13566 blanco

€ 98

R13567 gris antracita

€ 98

↑ 70
⚡ 172x62



LED

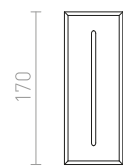

170

65

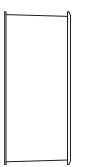

70 3



MEMPHIS

Aplique LED de pared, adecuado para brindar luz orientativa en pasillos y escaleras.

MEMPHIS R EMPOTRADA AL MURO

230 V LED 3 W $\angle 60^\circ$ 3000 K 270 lm Ra 80

R12687 gris plata € 35

R13956 blanco € 35 **NEW**

R13957 negro € 35 **NEW**

\perp 90

Ø45



LED

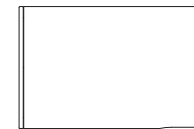

1,5 65

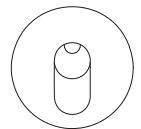

50

MEMPHIS SQ EMPOTRADA AL MURO

230 V LED 3 W $\angle 60^\circ$ 3000 K 270 lm Ra 80

R12688 gris plata € 38

R13954 blanco € 38 **NEW**

R13955 negro € 38 **NEW**

\perp 90

Ø40



LED



1,5 65

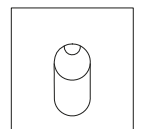

50

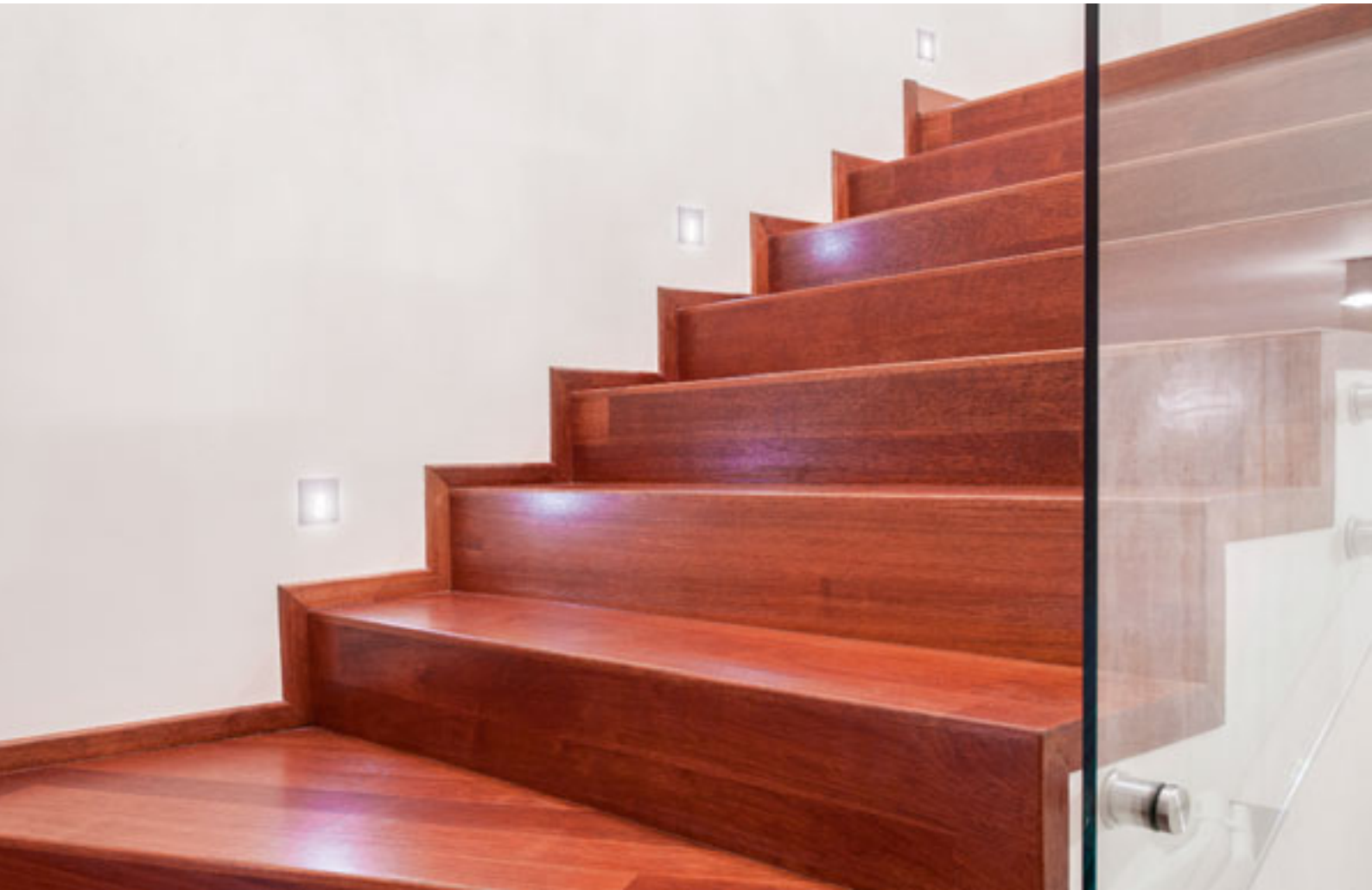

ELICA

Luminaria empotrada redonda de aluminio con la fuente de luz LED integrada. Se suministra con la caja de montaje.

ELICA R EMPOTRADA

230 V LED 3 W 3000 K 75 lm Ra 80 IP54

R12528 aluminio cepillado

€ 58 %

↑ 95
● Ø75



● LED

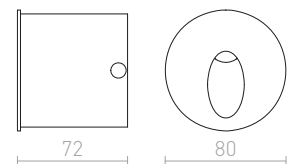

ELICA SQ EXTERIOR

230 V LED 3 W 3000 K 180 lm Ra 80 IP54

R10639 níquel mate

€ 35 %

R12529 aluminio cepillado

€ 58 %

↑ 70
● Ø75



● LED

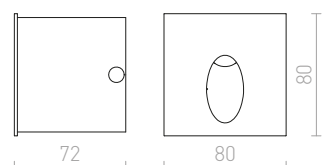





RIO

Luminaria LED empotrable para instalación en paredes huecas o nichos.

RIO R EMPOTRADA

230 V LED 3 W $\angle 22^\circ$ 3000 K 70 lm Ra 80

R12656 blanco

€ 22

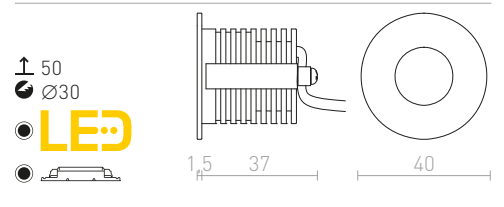

RIO SQ EMPOTRADA

230 V LED 3 W $\angle 22^\circ$ 3000 K 70 lm Ra 80

R12350 blanco

€ 19.50

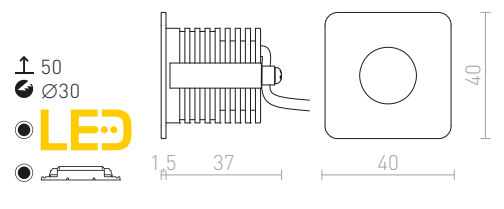

RIO SQ O EMPOTRADA

230 V LED 3 W $\angle 22^\circ$ 3000 K 70 lm Ra 80

R12655 blanco

€ 19.50

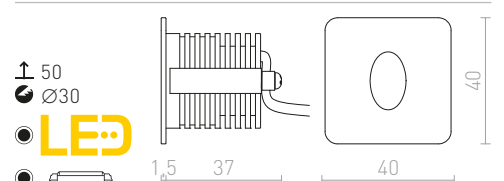



IP54



MARCO LED

Aplique redondo empotrado adecuado tanto para uso interior como exterior. Instalar sólo para iluminación hacia abajo. Caja de montaje incluida.

MARCO EMPOTRADA

230 V LED 3 W 3000 K 80 lm Ra 80 IP54

R12024 blanco € 48

R12029 gris plata € 48

R12030 gris antracita € 48

↑ 60
● Ø76



● LED

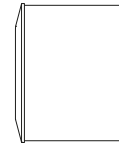

56

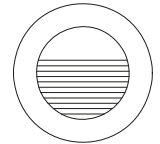

78



IP54

IP54



CLUB

Aplique LED cálido, brinda luz orientativa en pasillos y escaleras.

CLUB EMPOTRADA

230 V LED 3 W 3000 K 270 lm Ra 80 IP54

R12685 gris plata € 48

↑ 90
● Ø57

● LED

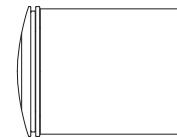

10

65

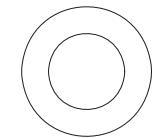

58

CLUB IND EMPOTRADA

230 V LED 3 W 3000 K 270 lm Ra 80 IP54

R12686 gris plata € 48

↑ 90
● Ø56



● LED

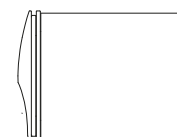

10

65

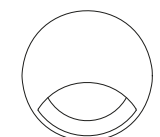

58



IP54



ASTERIA

Luminaria empotrada de pared para exteriores.
La abertura visible tiene una profundidad de 3 cm.
Instalar sólo para iluminación hacia abajo.

ASTERIA EMPOTRADA

230 V LED 3 W 3000 K 180 lm Ra 80 IP54

R10558 gris plata

€ 58 %

↑ 75

● Ø113



● LED

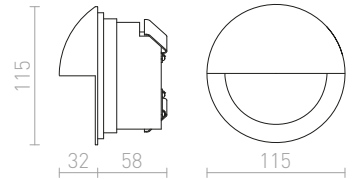





IP54



IP54



IP54

KICK

Luminaria empotrada de orientación con LED integrado que emite luz a uno, dos o tres lados. Diseñado para instalaciones en pared.

KICK I EMPOTRADA

230 V LED 3 W 3000 K 100 lm Ra 80 IP54

R12613 blanco

€ 48

R12615 negro

€ 48

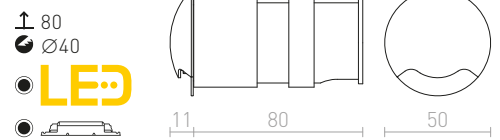

KICK II EMPOTRADA

230 V LED 3 W 3000 K 120 lm Ra 80 IP54

R12616 blanco

€ 48

R12618 negro

€ 48

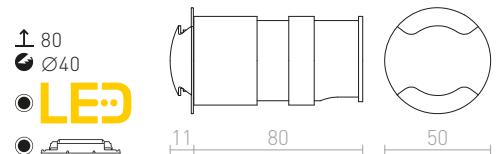

KICK III EMPOTRADA

230 V LED 3 W 3000 K 150 lm Ra 80 IP54

R12619 blanco

€ 48

R12621 negro

€ 48

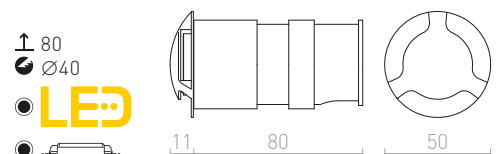



AMARO

Lámpara de pared LED, brinda luz orientativa en escaleras y pasillos.

AMARO EMPOTRADA

230 V LED 3 W $\angle 60^\circ$ 3000 K 270 lm Ra 80

R12690 blanco

€ 38

R13958 negro

€ 38

NEW



± 70

● Ø40



● LED

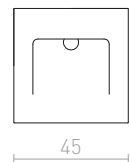
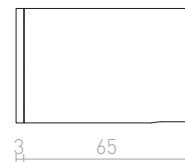



IP54



PER

Luminaria LED empotrable, adecuada para el uso en interiores y exteriores. Sirve para la iluminación orientativa en pavimentos, escaleras o terrazas.

PER EMPOTRADA

230 V LED 3 W 3000 K 76 lm Ra 80 IP54

R12576 blanco

€ 58

R12577 gris antracita

€ 58

↑ 60

▣ 65x102



LED

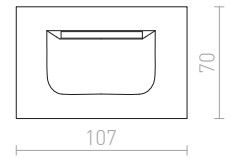

IP54



TESS

Aplique empotrable cuadrado apto para exterior e interior en tres colores. Incluye caja de montaje. Instalación sólo con iluminación hacia abajo.

TESS SQ EMPOTRADA

230 V LED 3 W 3000 K 80 lm Ra 80 IP54

R12013 blanco

€ 58

R12014 gris plata

€ 58

R12015 gris antracita

€ 58

↑ 70

▣ 60x55



LED

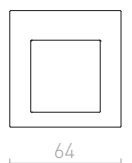
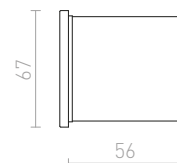



RAGG

Luminaria empotrable de exterior con luz direccional para iluminar aceras y escaleras.

RAGG EMPOTRADO

230 V LED 12 W 3000 K 406 lm Ra 80 IP65

R13620 blanco

€ 120

R13621 negro

€ 120

↑ 80

↙ 80x230



LED

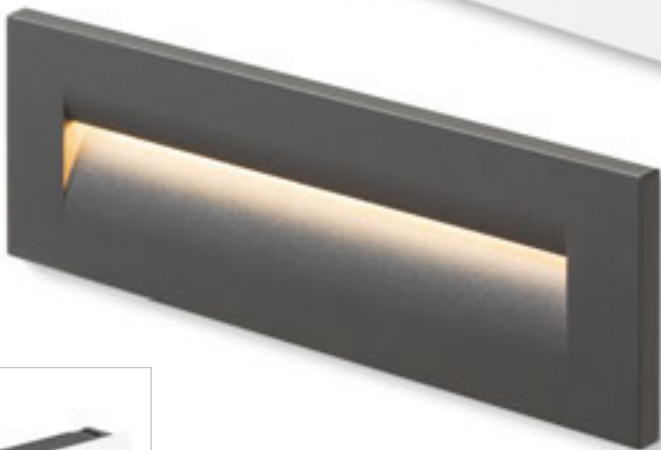
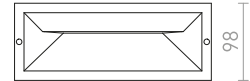

RASQ

Empotrable LED. Para la iluminación orientativa de pavimentos, escaleras o terrazas. Adecuado para el uso en interiores y exteriores. Instalar sólo para iluminación hacia abajo.

RASQ EMPOTRADA AL MURO

230 V LED 9 W 3000 K 190 lm Ra 80 IP65

R12627 blanco

€ 178

R12628 gris antracita

€ 178

↑ 80

↙ 237x77



LED

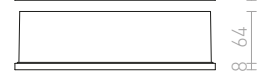
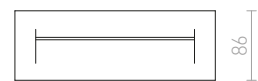

IP65



INTRO

Luminaria empotrable rectangular fabricada en aluminio cepillado con LED integrado. El panel frontal tiene un grosor de 0,3 cm. Se suministra con una caja de montaje. Sólo para instalación en serie.

INTRO L

350 mA LED 3W 3000 K 185 lm Ra 80

R10598 aluminio cepillado

€ 58 %

↑ 60

■ 86x146



● LED

○ G13124

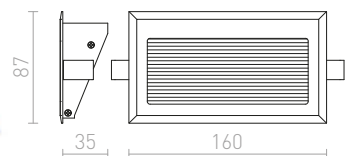





IP65



IP65



IP65



GORDIQ

Luminaria empotrable LED para la iluminación direccional de pavimentos, escaleras o terrazas. Instalar sólo iluminando hacia abajo.

GORDIQ L EMPOTRADA

230 V LED 3 W 3000 K 90 lm Ra 80 IP65

R12537 blanco

€ 68

R12538 gris antracita

€ 68

↑ 60

▣ 115x50

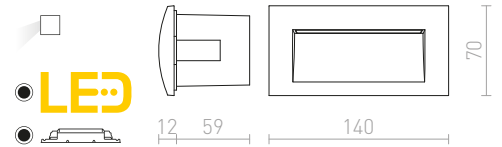

LED



GORDIQ M EMPOTRADA

230 V LED 3 W 3000 K 90 lm Ra 80 IP65

R12535 blanco

€ 88

R12536 gris antracita

€ 88

↑ 60

▣ 115x108

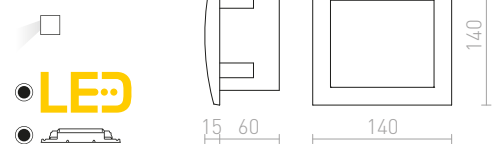

LED



GORDIQ S EMPOTRADA

230 V LED 1,5 W 3000 K 30 lm Ra 80 IP65

R12533 blanco

€ 58

R12534 gris antracita

€ 58

↑ 60

▣ 75x72

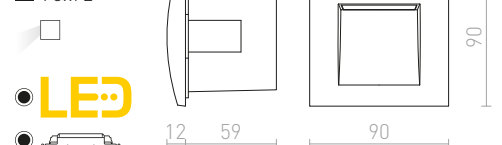

LED





IP65



IP65

DEJAVU

Luminaria LED empotrable para el montaje en pared.
Apta para la iluminación direccional de pavimentos,
escaleras o terrazas.

DEJAVU SQ 9 EMPOTRADA

230 V LED 3,5W 3000 K 120 lm Ra 80 IP65

R12530 negro

€ 58 %

↑ 70
72x75

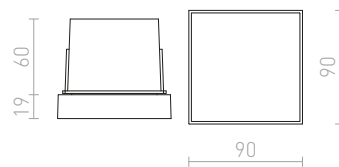

DEJAVU SQ 14 EMPOTRADA

230 V LED 6 W 3000 K 270 lm Ra 80 IP65

R12531 negro

€ 78 %

↑ 70
108x125

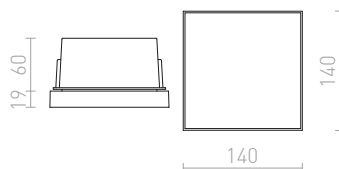





SISTEMA DE CARRILES 3F

3F TRIFÁSICO	490-495
3F FOCO	496-513
3F COLGANTE	514-531

SISTEMA DE CARRILES 1F

1F FASE	532-535
1F FOCO	536-545
COLGANTES 1F	546-555

TIRAS LED

TIRA DE LED	556-561
PERFIL	562-565



SISTEMA DE CARRILES 3F 3F TRIFÁSICO



EUTRAC 1m
490-495



EUTRAC 2m
490-495



EUTRAC 3m
490-495

490-495

SISTEMA DE CARRILES 3F 3F FOCO



FLATLINE 60
496-497



FLATLINE 150
496-497



FOCUS 12
498-499

496-513



FOCUS 20
498-499



FOCUS 30
498-499



WISH 20
500-501



WISH 30
500-501



OPTIMUS
500-501



ZUMA
500-501



MAVRO
502-503



LOLLIPOP
502-503



TRAX
502-503



MAVRO
502-503



BAHIA
504-505



PRODIGIS
504-505



FANGIO
504-505



DARIO
506-507



CONNOR
506-507



CADENZA
506-507



FORZA
508-509



BELENOS
508-509



DUDE
508-509



BEEBA I
510-511



BEEBA II
510-511



PURINA
510-511



TRICA
510-511



PIXIE
512-513



PIXIE
512-513



KELLY LED
512-513



FAX E27
512-513



FAX
512-513

SISTEMA DE CARRILES 3F 3F COLGANTE



LUNA 20
514-515



LUNA 25
514-515



LUNA 30
514-515

514-531



JULIETTA 16
516-517



JULIETTA 31
516-517



COPA
516-517



BELLINI
516-517



SANSSOUCI
518-519



GARNISH
518-519



EIGHT
518-519



CHOUPETTE
520-521



GIULIA 12
520-521



GIULIA 20
520-521



ARAQ
520-521



AGNETA
522-523



BLONDIE 25
522-523



ASTON
522-523



BUCKY 40
524-525



MONROE 30
524-525

SINTRA 30
524-525

BABADES
526-527

DESTY
526-527

BELENOS
526-527



MAVRO
526-527

JACK RC
528-529

BURTON
528-529

TUTTI
528-529

FRUTTI
528-529



ELISA
530-531

SISTEMA DE CARRILES 1F
1F FASE

532-535



1F 1m
532-535



1F 2m
532-535

SISTEMA DE CARRILES 1F
1F FOCO

536-545



FOCUS 12
536-537



FOCUS 20
536-537



OPTIMUS
536-537



WISH 20
538-539

WISH 30
538-539

MAVRO
538-539

BELENOS
540-541

FORZA
540-541



CADENZA
540-541



DUDE
540-541



CONNOR
542-543



LALA
542-543



SIENA
542-543



DARIO
542-543



TRICA
544-545



PURINA
544-545



BEEBA I
544-545



BEEBA II
544-545

SISTEMA DE CARRILES 1F COLGANTES 1F

546-555



LUNA 20
546-547



LUNA 25
546-547



LUNA 30
546-547



COPA
546-547



BELLINI L E14
548-549



PULIRE RD
548-549



PULIRE CON
548-549



ARAQ
548-549



GIULIA 12
550-551



GIULIA 20
550-551



JULIETTA 16
550-551



JULIETTA 31
550-551



ICAR
552-553



CHOUETTE
552-553



BABADES
552-553



BELENOS
552-553



MAVRO
552-553



ELISA
554-555



BLONDIE 25
554-555

DESTY
554-555

AGNETA
554-555

TIRAS LED TIRA DE LED

556-561



LED STRIP ORION RGB
556-557



LED STRIP ORION RGBW
556-557



LED STRIP ORION
558-559



Wi-fi ovladač 5v1
556-557



LEDSTRIPORION60,100,150
556-557



LED STRIP IP54 5m
560-561



LED STRIP IP20 5m
560-561



LED STRIP
560-561



LED STRIP
560-561

TIRAS LED PERFIL

562-565



LED PROFILE G
562-563



LED PROFILE H
562-563



LED PROFILE J
562-563



LED PROFILE I 30/60
562-563



LED PROFILE A
564-565



LED PROFILE B
564-565



LED PROFILE D
564-565

EUTRAC

CARRIL TRIFÁSICO

Barra trifásica EUTRAC. Cualquier perfil se puede cortar fácilmente a la longitud deseada. No es necesario cortar o doblar los extremos de los cables. Al utilizar fuentes halógenas, la altura mínima de instalación es de 2,5 m. Para el uso por debajo de esta altura, recomendamos el reemplazo con fuentes de LED. NOTA: Costes de flete adicionales pueden ocurrir en pedidos de carriles de 3 m.

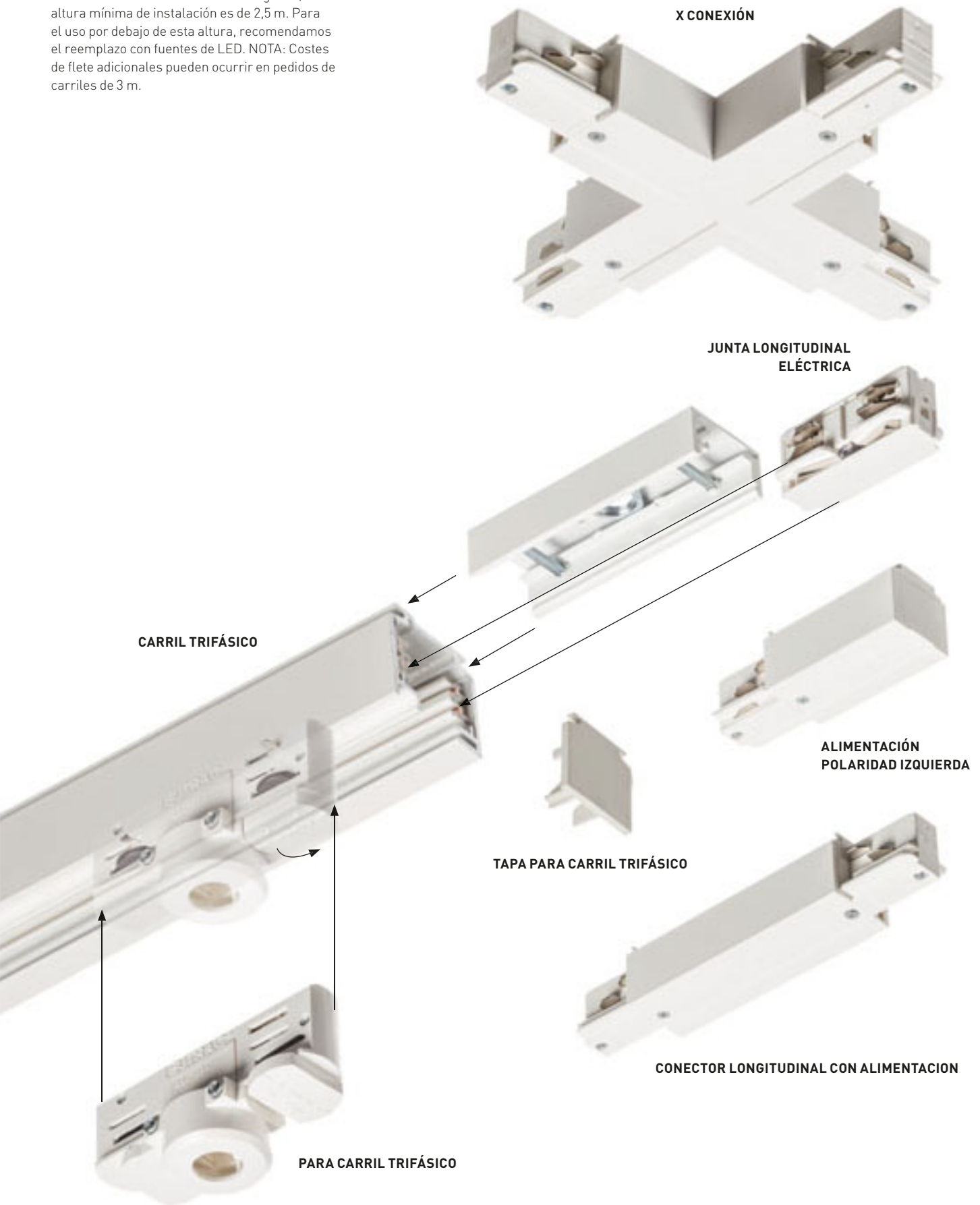

L CONECTOR POLARIDAD INTERNA



L CONECTOR POLARIDAD EXTERNA



CABLE DE SUSPENSIÓN



CONECTOR DE UNIÓN PARA CARRIL TRIFÁSICO



PARA CARRIL TRIFÁSICO

CONECTOR LONGITUDINAL CON ALIMENTACION

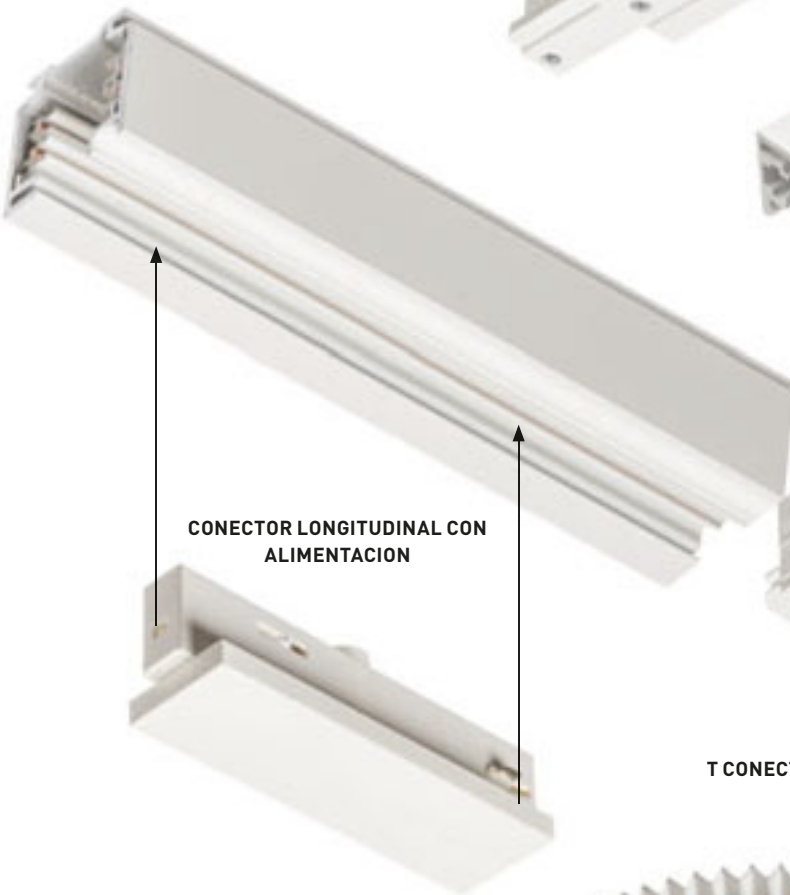

T CONECTOR POLARIDAD IZQUIERDA

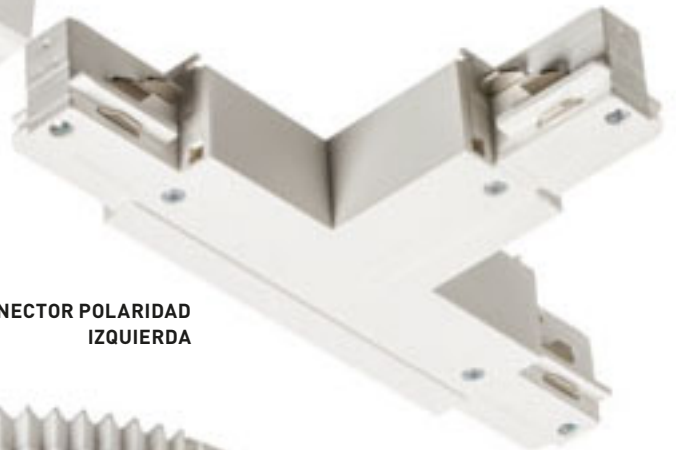

CONECTOR FLEX



ADAPTADOR MECÁNICO



EUTRAC

CARRIL TRIFÁSICO

Barra trifásica EUTRAC. Cualquier perfil se puede cortar fácilmente a la longitud deseada. No es necesario cortar o doblar los extremos de los cables. Al utilizar fuentes halógenas, la altura mínima de instalación es de 2,5 m. Para el uso por debajo de esta altura, recomendamos el reemplazo con fuentes de LED. NOTA: Costes de flete adicionales pueden ocurrir en pedidos de carriles de 3 m.

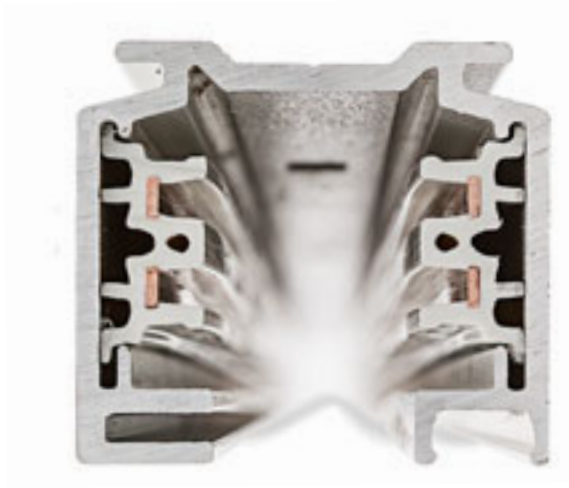

1M CARRIL TRIFÁSICO

230 V

R12072 blanco	€ 98
R12073 negro	€ 98
R12074 gris plata	€ 98

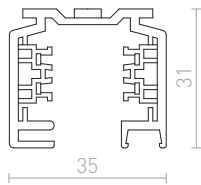

L CONECTOR POLARIDAD INTERNA

Conexión en L con fuente de alimentación para EUTRAC trifásica. Carga máxima 16 A.

230 V

R11326 blanco	€ 78
R11327 negro	€ 78
R11328 gris plata	€ 120

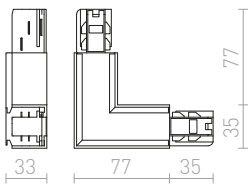

L CONECTOR POLARIDAD EXTERNA

Conexión en L con fuente de alimentación para EUTRAC trifásica empotrada. Carga máxima 16 A.

230 V

R11323 blanco	€ 78
R11324 negro	€ 78
R11325 gris plata	€ 120

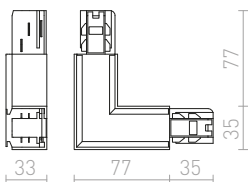

2M CARRIL TRIFÁSICO

230 V

R11300 blanco	€ 158
R11301 negro	€ 158
R11302 gris plata	€ 158

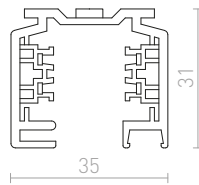

T CONECTOR POLARIDAD DERECHA

Conexión en T con fuente de alimentación para EUTRAC trifásica. Carga máxima 16 A.

230 V

R11332 blanco	€ 120
R11333 negro	€ 120
R11334 gris plata	€ 158

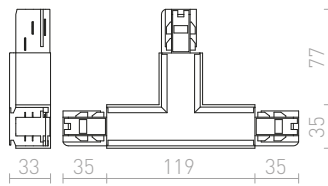

T CONECTOR POLARIDAD IZQUIERDA

Conexión en T con fuente de alimentación para EUTRAC trifásica. Carga máxima 16 A.

230 V

R11335 blanco	€ 120
R11336 negro	€ 120
R11337 gris plata	€ 158

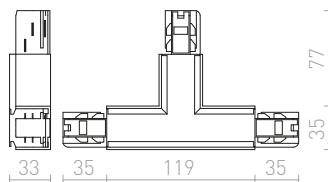

3M CARRIL TRIFÁSICO

230 V

R11303 blanco	€ 238
R11304 negro	€ 238
R11305 gris plata	€ 238

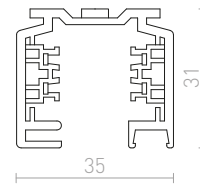

ALIMENTACIÓN POLARIDAD DERECHA

Fuente de alimentación del terminal para EUTRAC trifásica. Carga eléctrica máxima 16 A.

230 V

R11311 blanco	€ 35
R11312 negro	€ 35
R11313 gris plata	€ 48

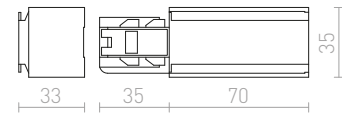

ALIMENTACIÓN POLARIDAD IZQUIERDA

Fuente de alimentación del terminal para EUTRAC trifásica. Carga eléctrica máxima 16 A.

230 V

R11314 blanco	€ 35
R11315 negro	€ 35
R11316 gris plata	€ 48

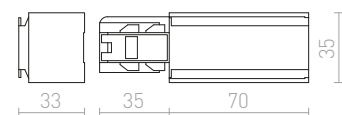

JUNTA LONGITUDINAL ELÉCTRICA

Unión conductiva longitudinal para carril trifásico EUTRAC. Por razones estáticas, se requiere una junta mecánica (R11354, R11355 o R11356) para el montaje de la suspensión. Posibilidad de cargar eléctrica hasta 16 A. 230 V

- R11317** blanco € 24
- R11318** negro € 24
- R11319** gris plata € 29

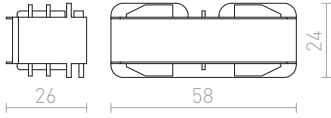

CONECTOR FLEX

Junta conductora flexible para carril trifásico EUTRAC. Radio 30 °-330 °. Con esta conexión, es posible alimentar el sistema de barras. Carga máxima 16A.

- 230 V
- R11329** blanco € 120
- R11330** negro € 120
- R11331** gris plata € 120

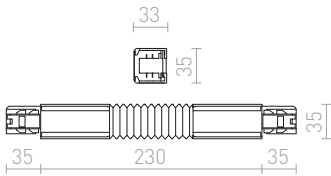

CONECTOR LONGITUDINAL CON ALIMENTACION

Unión longitudinal conductora con fuente de alimentación para EUTRAC trifásica. Carga eléctrica máxima 16 A.

- 230 V
- R11320** blanco € 78
- R11321** negro € 78
- R11322** gris plata € 120

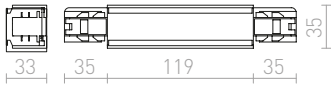

X CONEXIÓN

Conexión X con fuente de alimentación para EUTRAC trifásica. Posibilidad de alimentar dos circuitos separados. Carga eléctrica máxima 16A.

- 230 V
- R11338** blanco € 150
- R11339** negro € 150
- R11340** gris plata € 198

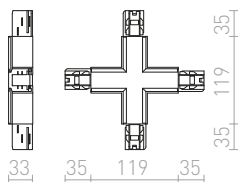

CONECTOR LONGITUDINAL CON ALIMENTACION

Fuente de alimentación continua para EUTRAC trifásica sin la necesidad de dividir el riel. Posibilidad de cargar hasta 16 A.

- 230 V
- R11346** blanco € 58
- R11347** negro € 58
- R11348** gris plata € 78

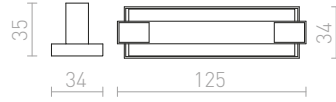

PARA CARRIL TRIFÁSICO

Carga máxima de 5 kg y 10A.

- 230 V
- R11360** blanco € 32
- R11361** negro € 32
- R11362** gris plata € 48

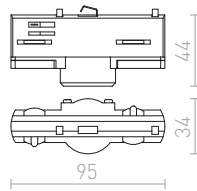

TAPA PARA CARRIL TRIFÁSICO

Tapa final para EUTRAC trifásica.

- R11307** blanco € 3.20
- R11308** negro € 3.20
- R11309** gris plata € 6

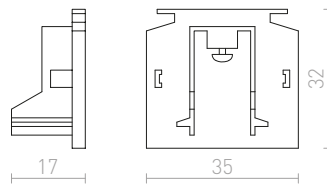

ADAPTADOR MECÁNICO

Adaptador mecánico tanto para carril trifásico EUTRAC montado en superficie o empotrado. Carga máxima 10 kg.

- R11352** blanco € 25
- R11353** negro € 25

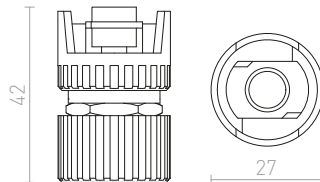

3M CABLE DE SUSPENSIÓN

Suspensión de cable para carril trifásico EUTRAC. Hilo M13.

- R11359** € 48

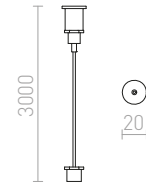

1,5M CABLE DE SUSPENSIÓN

Suspensión de cable para carril trifásico EUTRAC. Hilo M13.

- R11358** € 48

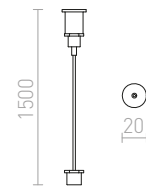

PARA CARRIL TRIFÁSICO

Adaptador para fijar la suspensión del cable. Hilo M13.

- R11349** blanco € 14
- R11350** negro € 14
- R11351** gris plata € 16

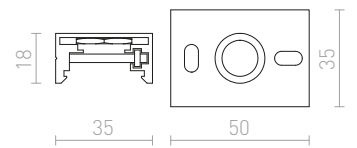

CONECTOR DE UNIÓN PARA CARRIL TRIFÁSICO

La junta mecánica para fortalecer los sistemas de rieles suspendidos en el punto de interconexión junto con un conector.

- R11354** blanco € 24
- R11355** negro € 24
- R11356** gris plata € 26

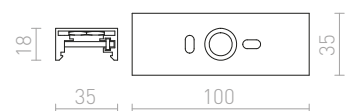

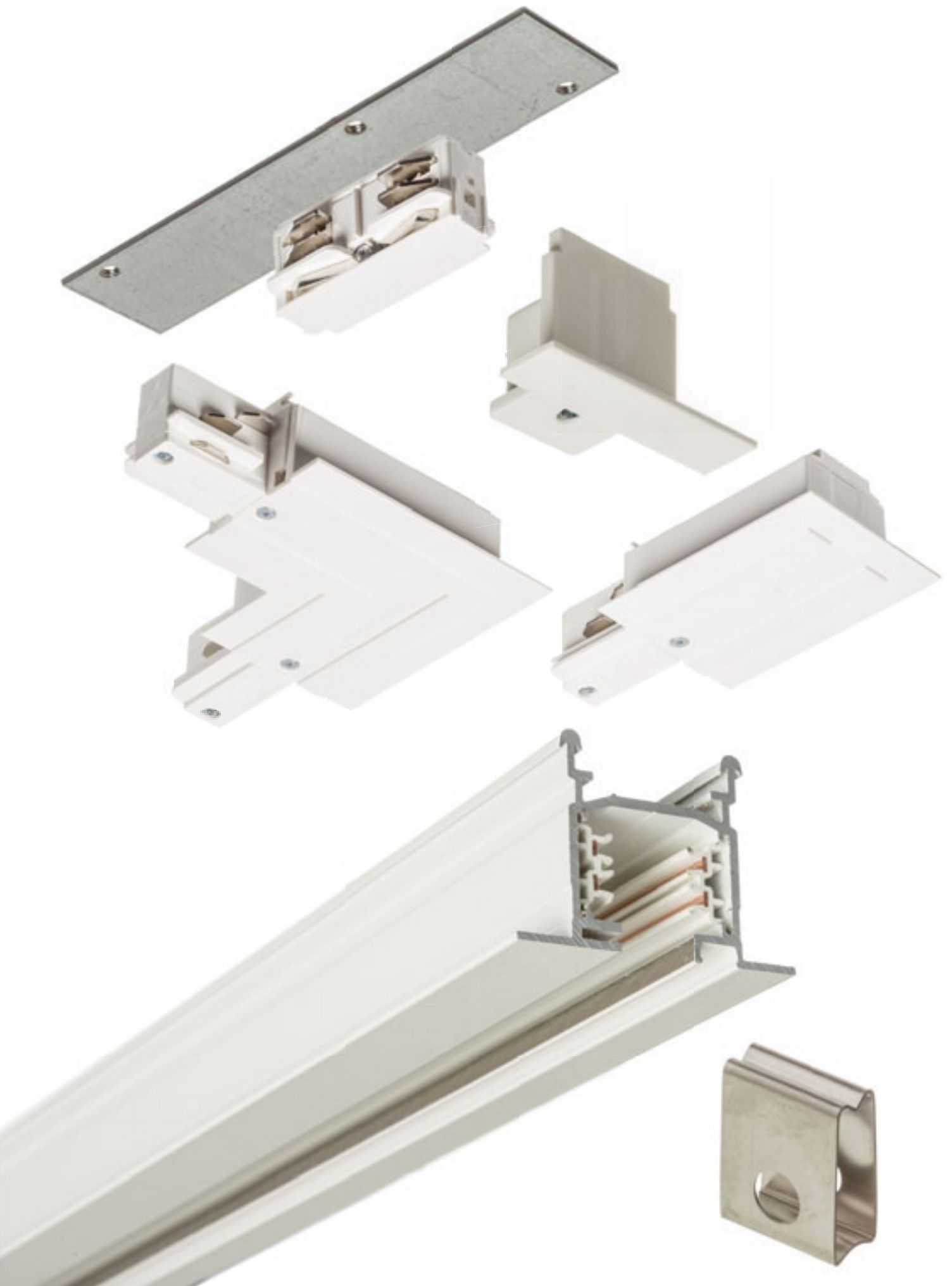

CARRIL TRIFÁSICO EMPOTRADO

EUTRAC pista empotrada trifásica, compuesta por un perfil de aluminio extruido, con conexión a tierra incorporada y cuatro cables de cobre de 2,5 mm que atraviesan dos perfiles de plástico incrustados. Los perfiles se pueden cortar fácilmente en las longitudes deseadas, sin necesidad de cortar o doblar ningún cable. Si se usa con fuentes de luz halógenas, la altura mínima requerida es de 2.5 m. Para una instalación más baja, recomendamos usar fuentes de luz LED en su lugar.

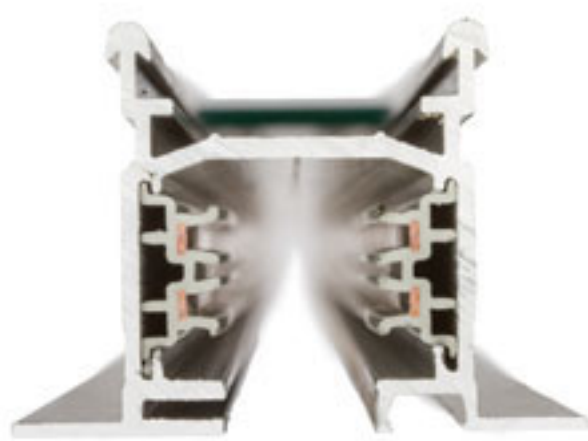

ALIMENTACIÓN PARA CARRIL TRIFÁSICO EMPOTRADO POLARIDAD IZQUIERDA

Fin de la fuente de alimentación para EUTRAC empotrada trifásica. Carga eléctrica máxima 16 A.

230 V
R11342 blanco € 48

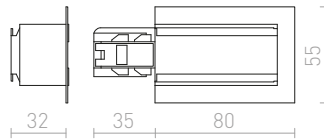

ALIMENTACIÓN PARA CARRIL TRIFÁSICO EMPOTRADO POLARIDAD DERECHA

Fin de la fuente de alimentación para EUTRAC empotrada trifásica. Carga máxima 16 A.

230 V
R11341 blanco € 48

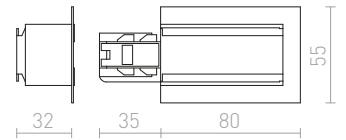

L CONECTOR PARA CARRIL TRIFÁSICO EMPOTRADO POLARIDAD EXTERNA

Conexión en L con fuente de alimentación para EUTRAC trifásica empotrada. Carga máxima 16 A.

230 V
R11344 blanco € 88

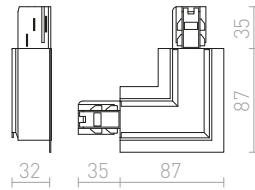

L CONECTOR PARA CARRIL TRIFÁSICO EMPOTRADO POLARIDAD INTERNA

Conexión en L con fuente de alimentación para EUTRAC trifásica empotrada. Carga máxima 16 A.

230 V
R11345 blanco € 88

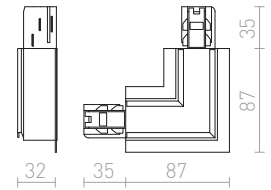

2M CARRIL TRIFÁSICO EMPOTRADO

230 V
R11306 blanco € 238

41
 2000x40

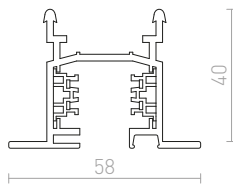

CONECTOR LONGITUDINAL PARA CARRIL TRIFÁSICO

Conector longitudinal para carriles EUTRAC empotrados. Carga máxima 16A.

230 V
R11343 blanco € 32

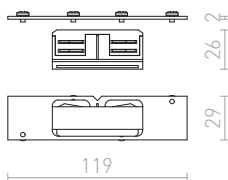

TAPA FINAL PARA LA TRIFÁSICA EMPOTRADA

Tapa final para EUTRAC trifásica empotrada.

R11310 blanco € 8

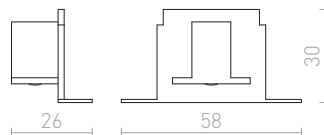

AGARRE FLEXIBLE EMPOTRADO PARA CARRIL TRIFÁSICO 6 PIEZAS

Clips de montaje de ajuste para EUTRAC trifásica empotrada.

R11357 € 16

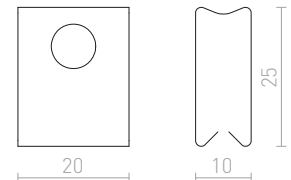





FLATLINE

Luminaria lineal con iluminación ambiental para carriles trifásicos. Se pueden configurar diferentes salidas de luz en el adaptador de luminaria: 35W, 40W, 45W o 50W.

FLATLINE 150 PARA CARRIL TRIFÁSICO
230 V LED 50 W $\angle 90^\circ$ 3000 K 8000 lm Ra 80

R13732 blanco

€ 258

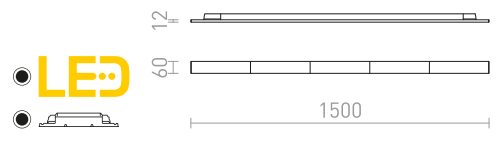

FLATLINE

Luminaria lineal con iluminación ambiental para carriles trifásicos. Se pueden configurar diferentes salidas de luz en el adaptador de luminaria: 14W, 16W, 18W o 20W.

FLATLINE 60 PARA CARRIL TRIFÁSICO
230 V LED 20 W $\angle 90^\circ$ 3000 K 3200 lm Ra 80

R13731 blanco

€ 188

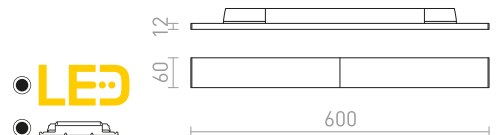





FOCUS

Proyector regulable en forma de tubo para carriles trifásicos, con capacidad de ajustar el ángulo del haz entre 10 - 60° con la llamada función de zoom. La temperatura del color de la luz puede cambiarse utilizando un interruptor en la luz: 3000K, 4000K, 5000K. Atenuación TRIAC.

FOCUS 12 DIMM PARA CARRIL TRIFÁSICO

230 V LED 12 W $\angle 10-60^\circ$ 3000 K 4000 K 5000 K
780 lm Ra 80

R13882 blanco

€ 98 NEW

R13883 negro

€ 98 NEW

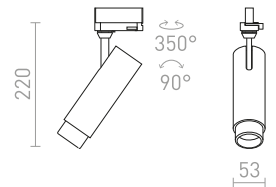

FOCUS 20 DIMM PARA CARRIL TRIFÁSICO

230 V LED 20 W $\angle 10-60^\circ$ 3000 K 4000 K 5000 K
1540 lm Ra 80

R13884 blanco

€ 120 NEW

R13885 negro

€ 120 NEW

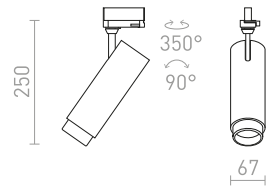

FOCUS 30 DIMM PARA CARRIL TRIFÁSICO

230 V LED 30 W $\angle 10-60^\circ$ 3000 K 4000 K 5000 K
2300 lm Ra 80

R13886 blanco

€ 150 NEW

R13887 negro

€ 150 NEW

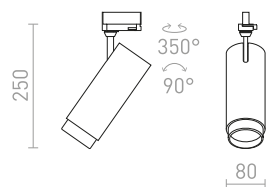



ZUMA

Foco tubular para carril trifásico con la posibilidad de ajustar el cono de luz utilizando un sistema de zoom de 10-50°. Atenuación TRIAC.

ZUMA DIMM PARA CARRIL TRIFÁSICO

230 V LED 20 W $\angle 10-50^\circ$ 3000 K 1000 lm Ra 80

R13529 blanco

€ 129

R13531 negro

€ 129

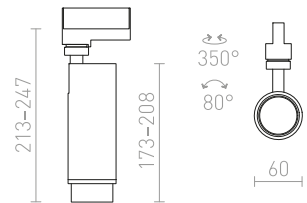

OPTIMUS

Luminaria cilíndrica para carriles trifásicos con posibilidad de ajustar el cono de luz mediante un sistema de zoom de 10-50°. La luminaria es apta para fuentes de luz LED con casquillo GU10. Recomendamos utilizar fuentes de luz con un ángulo de haz de 120° para evitar sombras no deseadas.

OPTIMUS PARA CARRILES TRIFÁSICOS

230 V LED GU10 9 W $\angle 10-50^\circ$

R13783 blanco

€ 68

R13784 negro

€ 68

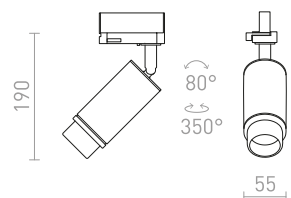



WISH

Luminaria cilíndrica regulable para carriles trifásicos con color de luz regulable: blanco cálido (WW), blanco neutro (NW), blanco frío (CW). Regulación TRIAC.

WISH 20 DIMMABLE PARA CARRILES TRIFÁSICOS

230 V LED 20 W $\angle 36^\circ$ 3000 K 4000 K 5000 K
1600 lm Ra 80

R13773 blanco

€ 120

NEW

R13774 negro

€ 120

NEW



regulable

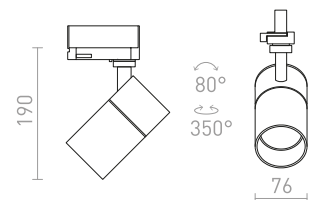

WISH 30 DIMMABLE PARA CARRILES TRIFÁSICOS

230 V LED 30 W $\angle 36^\circ$ 3000 K 4000 K 5000 K
2400 lm Ra 80

R13775 blanco

€ 129

NEW

R13776 negro

€ 129

NEW



regulable

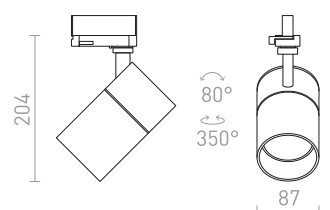



LOLLIPOP

Proyector cilíndrico para carril trifásico con fuente de luz LED integrada.

LOLLIPOP PARA CARRIL TRIFÁSICO

230 V LED 8 W $\angle 40^\circ$ 3000 K 620 lm Ra 80

R12412 blanco

€ 48 %

R12413 negro

€ 48 %

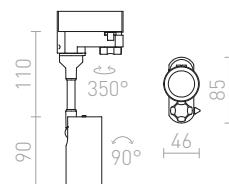

TRAX

Proyector minimalista con LED integrado para carril trifásico. El interior y el exterior de la luz son de colores contrastantes.

TRAX PARA CARRIL TRIFÁSICO

230 V/400 mA LED 15 W $\angle 38^\circ$ 3000 K 1370 lm Ra 80

R11694 blanco/oro

€ 120 %

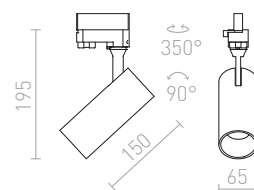

MAVRO

Foco cilíndrico con LED incorporado para carriles trifásicos. Atenuación TRIAC.

MAVRO DIMM PARA CARRIL TRIFÁSICO

230 V LED 12 W $\angle 38^\circ$ 3000 K 1020 lm Ra 80

R13171 blanco

€ 178

R13172 oro

€ 178

R13173 negro/oro

€ 178

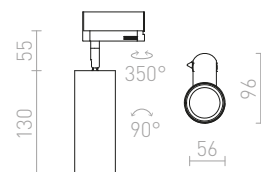



MAVRO

Foco cilíndrico con LED integrado para carriles trifásicos.

MAVRO PARA CARRIL TRIFÁSICO

230 V LED 12 W $\angle 38^\circ$ 3000 K 1020 lm Ra 80

R12995 blanco

€ 120

R12996 oro

€ 120

R12997 negro/oro

€ 120

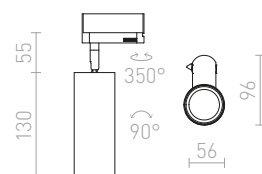



FANGIO

Luminaria reflectora en tres versiones de color para carril trifásico.

FANGIO PARA CARRIL TRIFÁSICO

230 V LED 25 W $\angle 36^\circ$ 3000 K 2200 lm Ra 80

R12059 gris plata

€ 88 %

R12060 negro

€ 88 %

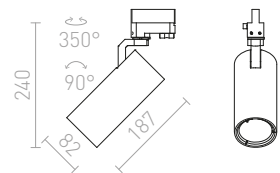



BAHIA

Potente reflector LED para carril trifásico.

BAHIA PARA CARRIL TRIFÁSICO

230 V LED 28 W $\angle 38^\circ$ 3000 K 2700 lm Ra 80

R12823 blanco

€ 150

R12824 negro

€ 150

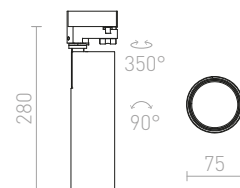

PRODIGI

Reflector cilíndrico para rieles trifásicos. La luminaria viene con un LED de 10 W.

PRODIGI S PARA CARRIL TRIFÁSICO

230 V LED 10 W $\angle 36^\circ$ 3000 K 1000 lm Ra 80

R13000 blanco

€ 78

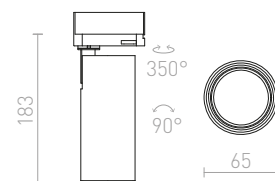

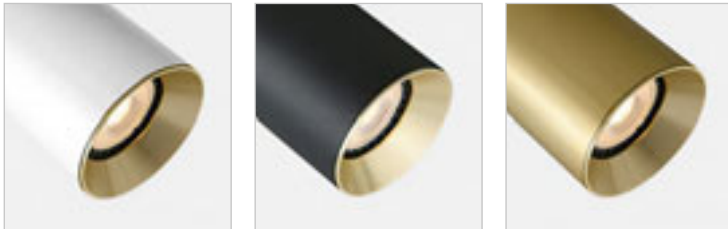

DARIO

Proyector cilíndrico con casquillo GU10 para fuentes de luz LED, incluye pantalla decorativa de latón negro cepillado. Hay diferentes combinaciones de colores disponibles comprando pantallas adicionales en otros colores. Para ser utilizado en carriles trifásicos.

DARIO PARA CARRIL TRIFÁSICO

230 V GU10 9 W

R13873 blanco/latón cepillado

€ 98

NEW

R13874 negro/latón cepillado

€ 98

NEW

R13875 latón cepillado

€ 120

NEW

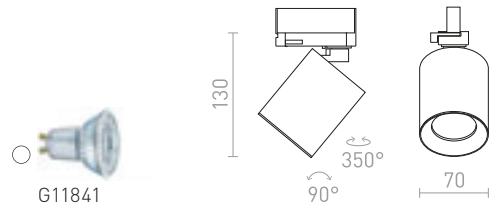

DARIO

Pantalla interior decorativa de metal en varios colores para la lampara DARIO.

DARIO ANILLO DECORATIVO

R13876 blanco

€ 8.50

NEW

R13877 negro

€ 8.50

NEW

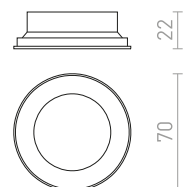



CADENZA

Foco cilíndrico con casquillo GU10 para carriles trifásicos.

CADENZA PARA CARRILES TRIFÁSICOS

230 V LED GU10 10 W

R13348 blanco

€ 68

R13349 negro

€ 68

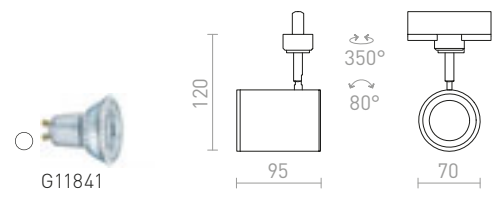

CONNOR

Foco cilíndrico con casquillo GU10 para carriles trifásicos.

CONNOR PARA CARRIL TRIFÁSICO

230 V LED GU10 10 W

R13499 blanco/negro

€ 68

R13500 negro/oro

€ 68

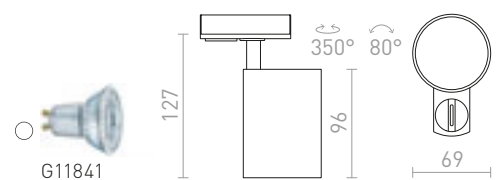



DUDE

proyector cilíndrico con casquillo GU10 para fuentes de luz LED y adaptador para carriles trifásicos.

DUDE PARA CARRIL TRIFÁSICO

230 V LED GU10 9 W

R13928 blanco

€ 58 **NEW**

R13929 negro

€ 58 **NEW**

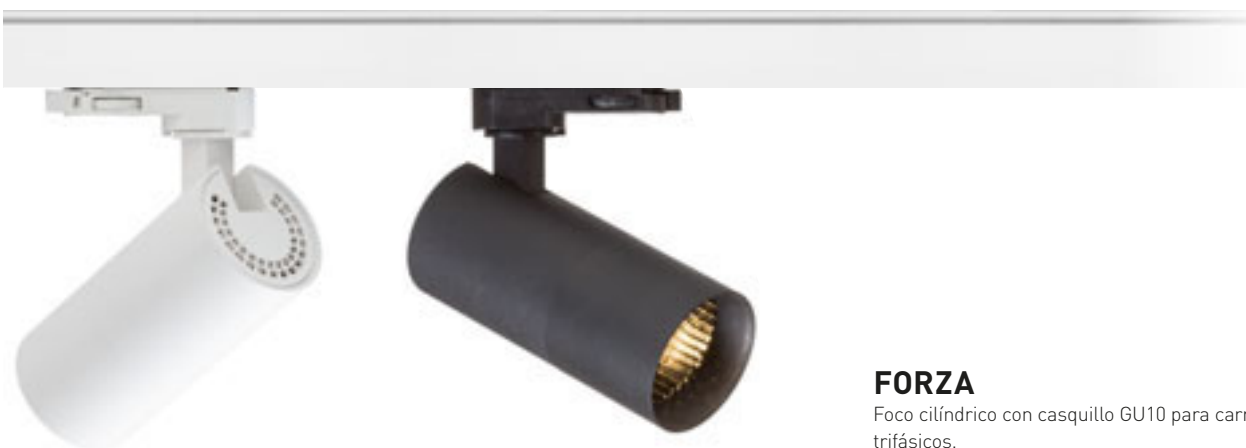
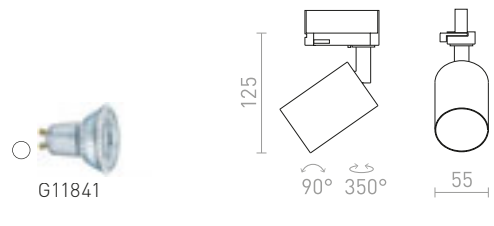

FORZA

Foco cilíndrico con casquillo GU10 para carriles trifásicos.

FORZA PARA CARRILES TRIFÁSICOS

230 V LED GU10 10 W

R13352 blanco

€ 78

R13353 negro

€ 78

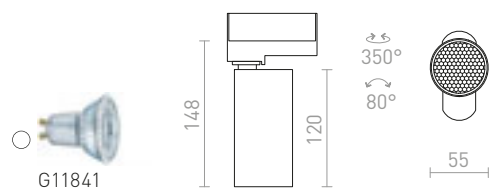



BELENOS

Foco cilíndrico minimalista con casquillo GU10 para carriles trifásicos. Los resortes del casquillo permiten el uso de fuentes de luz de varias longitudes.

BELENOS PARA CARRILES TRIFÁSICOS

230 V LED GU10 9 W

R13368 blanco

€ 68

R13370 negro

€ 68

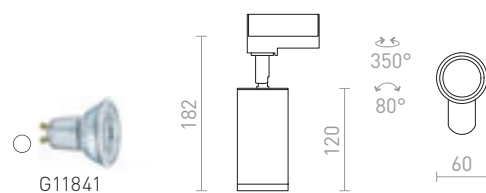

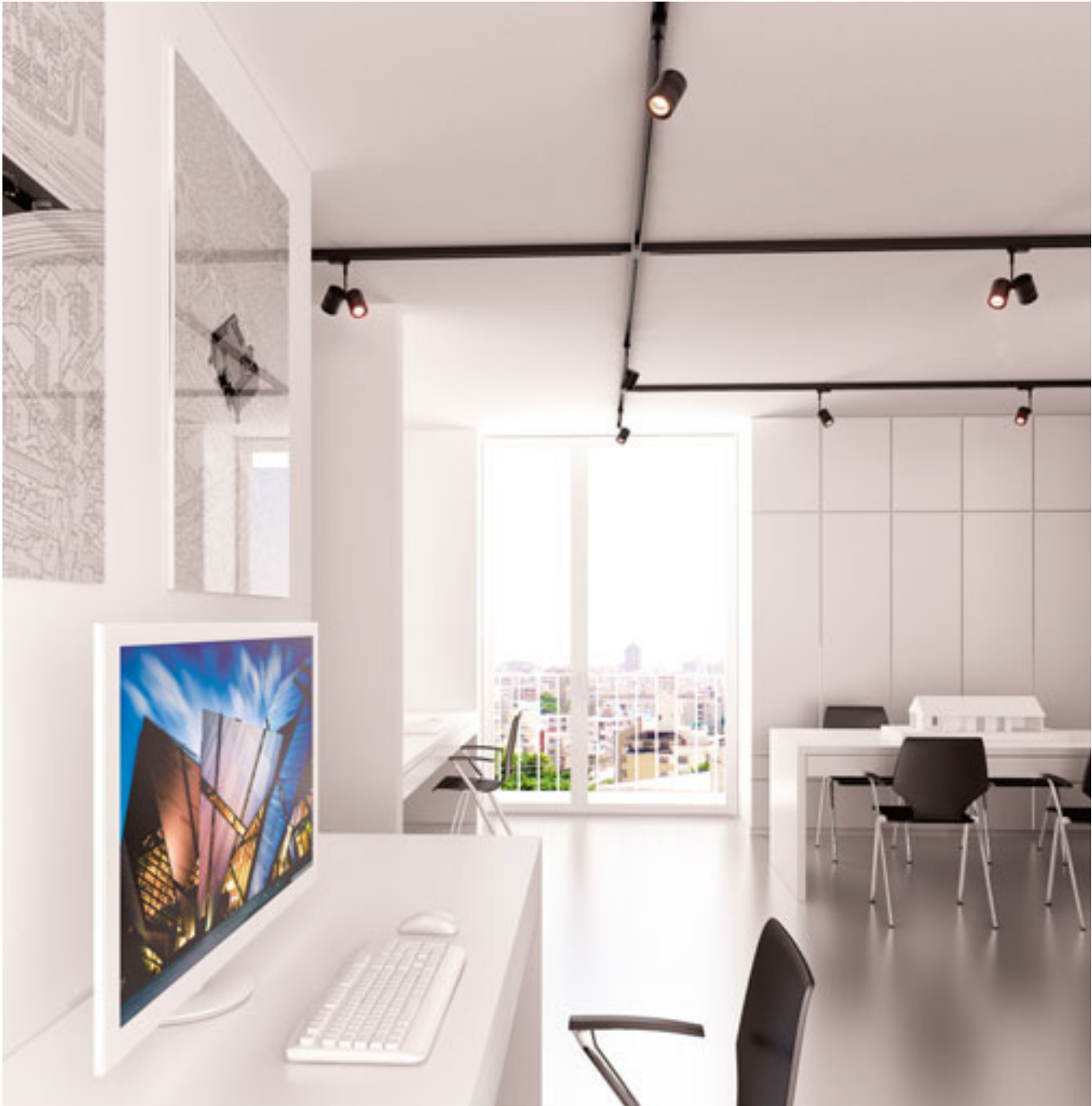

TRICA

Proyector con casquillo GU10 para carril trifásico. Se pueden utilizar fuentes de luz de 111 mm y 51 mm de diámetro. Todas las medidas se especifican sin fuente de luz.

TRICA PARA CARRIL TRIFÁSICO

230 V GU10 50 W

R12006 negro

€ 32

R12007 blanco

€ 32



G12723

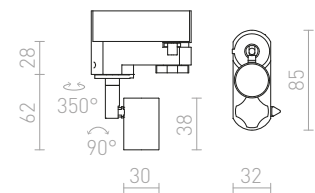



PURINA

Luminaria para carril trifásico en tres colores. Incluye un anillo decorativo para lámparas GU10 con un diámetro del reflector de 51 mm. También se pueden usar las fuentes de luz ES111.

PURINA PARA CARRIL TRIFÁSICO

230 V GU10 50 W

R12317 blanco € 26 %

R12318 gris plata € 26 %

R12319 negro € 48 %



G11841

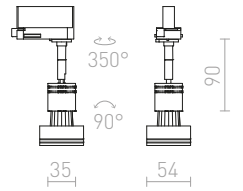

BEEBA

Luminaria para barras trifásicas en tres variantes de color.

BEEBA I PARA CARRIL TRIFÁSICO

230 V GU10 35 W

R12305 blanco € 68 %

R12306 gris plata € 48 %

R12307 negro € 68 %



G11837

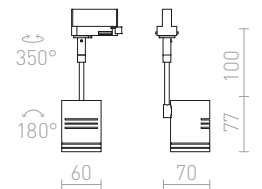

BEEBA II PARA CARRIL TRIFÁSICO

230 V GU10 2x35 W

R12311 blanco € 98 %

R12312 gris plata € 58 %

R12313 negro € 98 %



G11837

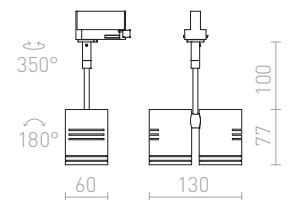



PIXIE

Luminaria inclinable de aluminio con adaptador para carriles trifásicos. Diseñada para bombillas de bajo consumo energético con casquillo GX53.

PIXIE EN CUELLO DE GANCO PARA CARRIL TRIFÁSICO

230 V LED GX53 7 W

R10641 gris plata/cromo

€ 158 →

R11768 blanco

€ 178

R11769 negro

€ 178



PIXIE PARA CARRIL TRIFÁSICO

230 V LED GX53 7 W

R10640 gris plata/cromo

€ 178

R10644 blanco/cromo

€ 178

R10645 negro/cromo

€ 178

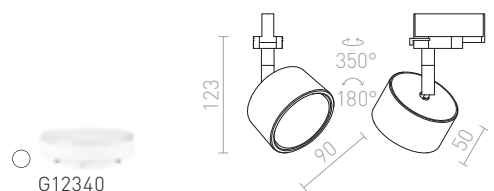



FAX

Luminaria para carril adecuada para fuentes de reflector con casquillo E27.

FAX E27 PARA CARRIL TRIFÁSICO

230 V E27 25 W

R13535 blanco

€ 32

R13537 negro

€ 32

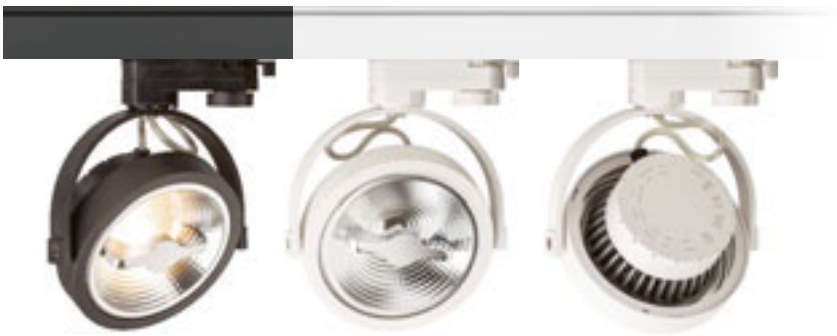
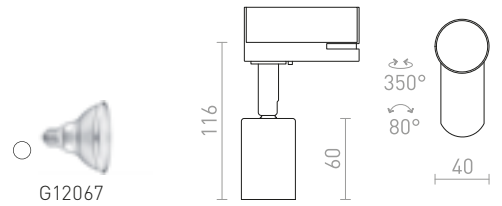

KELLY LED

Foco para carriles trifásicos con LED integrado.

KELLY LED PARA CARRIL TRIFÁSICO

230 V LED 12 W $\angle 24^\circ$ 3000 K 600 lm Ra 80

R12338 blanco

€ 120

R12339 negro

€ 120

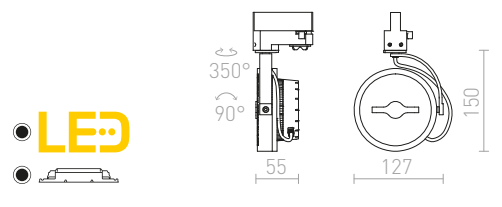

FAX

Luminaria para sistema de carril trifásico. El producto está equipado con GU10. La fuente de luz se puede usar con un diámetro de 111 mm o 51 mm. Las dimensiones del cuerpo son \varnothing/L 5/6,5 cm sin la fuente de luz.

FAX PARA CARRIL TRIFÁSICO

230 V GU10 50 W

R11724 negro

€ 48

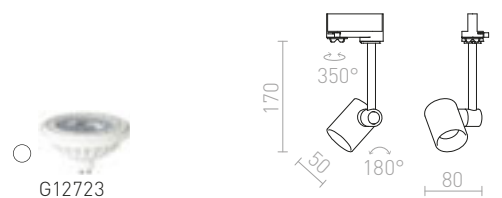





LUNA

Colgante de cristal de color ópalo con detalles en cromo y cable transparente al que se une un adaptador para carril trifásico.

LUNA 20 PARA CARRIL TRIFÁSICO

230 V LED E27 15 W

R13967 vidrio opal/cromo

€ 129 **NEW**

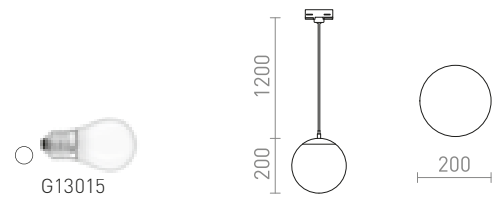

LUNA 25 PARA CARRIL TRIFÁSICO

230 V LED E27 15 W

R13968 vidrio opal/cromo

€ 178 **NEW**

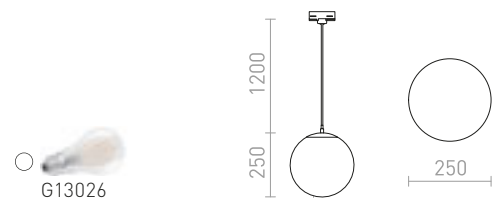

LUNA 30 PARA CARRIL TRIFÁSICO

230 V E27 15 W

R13969 vidrio opal/cromo

€ 229 **NEW**

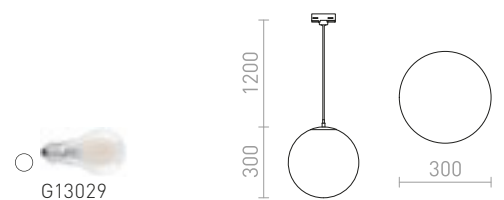



BELLINI

Luminaria colgante en vidrio con accesorios lacados para bombilla LED con csquillo E14. El cable de alimentación se termina con un adaptador para carriles trifásicos.

BELLINI PARA SISTEMA TRIFÁSICO

230 V E14 15 W

R13814 blanco/vidrio transparente

€ 215

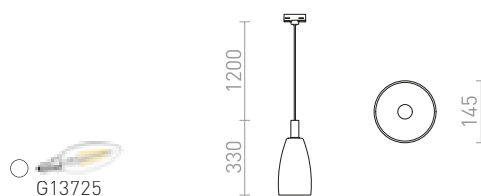

JULIETTA

Colgante con pantalla cilíndrica en color ópalo, detalles en metal lacado, cable textil negro y adaptador para carril trifásico.

JULIETTA 16 PARA CARRIL TRIFÁSICO

230 V E27 20 W

R13855 vidrio opal/negro

€ 150

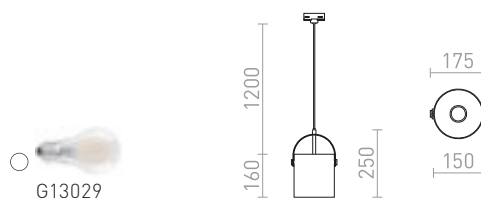

JULIETTA 31 PARA CARRIL TRIFÁSICO

230 V E27 20 W

R13856 vidrio opal/negro

€ 178

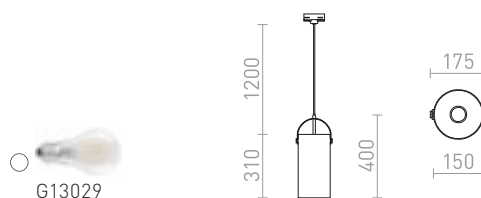



COPA

Luminaria colgante con una pantalla de vidrio para carril trifásico. Disponible en dos colores.

COPA PARA CARRILES TRIFÁSICOS

230 V E27 28 W

R13207 vidrio opal

€ 188

R13208 negro/vidrio

€ 198

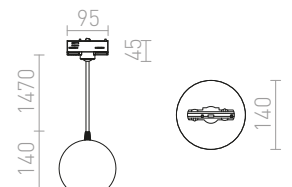



GARNISH

Lámpara colgante con pantalla de cristal transparente y accesorios cromados. La pantalla de vidrio está cerrada en la parte inferior y es posible insertar decoraciones adecuadas en ella. El cable de alimentación se termina con un adaptador para carriles trifásicos.

GARNISH PARA SISTEMA TRIFÁSICO

230 V GU10 9 W

R13815 vidrio transparente/cromo

€ 178



G11837

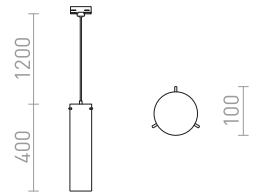

EIGHT

Colgante con pantalla en color ópalo, detalles en cromo y adaptador para carril trifásico.

EIGHT PARA CARRIL TRIFÁSICO COLGANTE

230 V E27 28 W

R13854 vidrio opal/cromo

€ 178



G13155

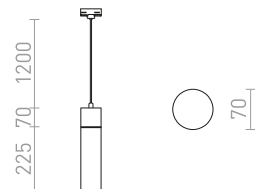



SANSSOUCI

Luminaria colgante con pantalla de vidrio y adaptador para carril trifásico. La pantalla aparece reflectante cuando no está iluminada y parcialmente translúcida cuando la luz está encendida.

SANSSOUCI PARA CARRIL TRIFÁSICO

230 V E27 42 W

R12095 cristal cromado

€ 129

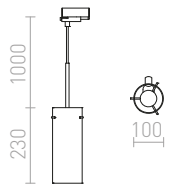

SANSSOUCI PARA CARRIL TRIFÁSICO

230 V E27 42 W

R12094 vidrio tintado de cobre

€ 129

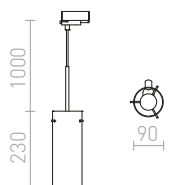



GIULIA

Lámpara colgante con pantalla de metal lacado y cable textil. El cable va unido a un adaptador para carril trifásico.

GIULIA 12 PARA CARRIL TRIFÁSICO

230 V E27 40W

R13990 blanco/cromo

€ 88 NEW

R13991 negro/dourado cinza/latón

€ 98 NEW

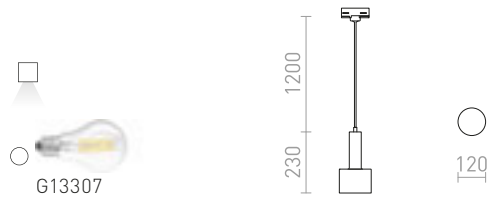

GIULIA 20 PARA CARRIL TRIFÁSICO

230 V E27 40W

R13992 blanco/cromo

€ 98 NEW

R13993 negro/dourado cinza/latón

€ 120 NEW

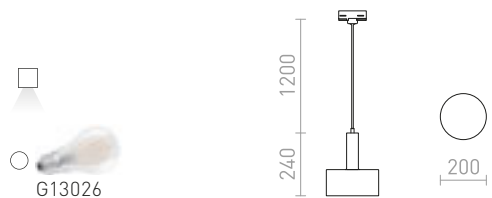



ARAQ

Colgante con casquillo de latón, cable textil y adaptador para carril trifásico. Apto para bombillas decorativas E27.

ARAQ PARA CARRIL TRIFÁSICO COLGANTE

230 V E27 42 W

R13979 latón cepillado/negro

€ 68 **NEW**



G13023



CHOUPEPTE

Luminaria textil suspendida con accesorio de madera para bombilla LED con casquillo E27 para instalación en carril trifásico.

CHOUPEPTE PARA VÍAS DE TRES CIRCUITOS

230 V E27 15 W

R13721 gris negruzco/textil/madera

€ 150



G13014

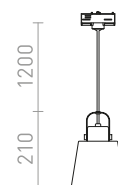

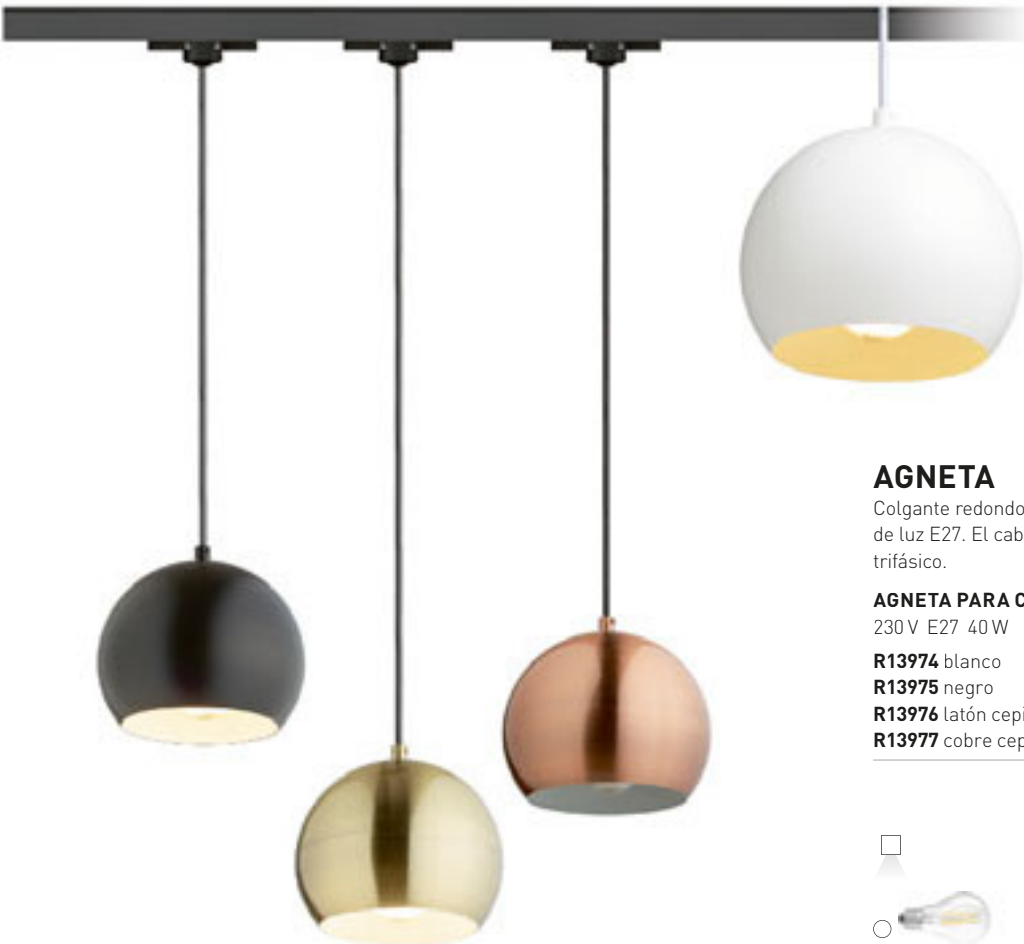

AGNETA

Colgante redondo de metal para usar con una fuente de luz E27. El cable va unido a un adaptador para carril trifásico.

AGNETA PARA CARRIL TRIFÁSICO COLGANTE

230 V E27 40 W

R13974 blanco	€ 98	NEW
R13975 negro	€ 98	NEW
R13976 latón cepillado	€ 120	NEW
R13977 cobre cepillado	€ 120	NEW

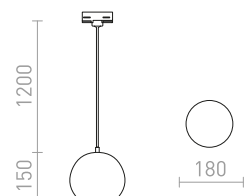



ASTON

Lámpara colgante de metal con cable transparente para carriles trifásicos.

ASTON PARA CARRIL TRIFÁSICO

230 V E27 42 W

R12100 aluminio cepillado

€ 98 %

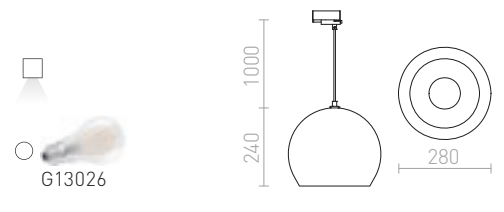

BLONDIE

Lámpara colgante con pantalla metálica abollada. El exterior de la pantalla es de color cobre y el interior está lacado en blanco. Se suministra con un cable de PVC negro con adaptador para carriles trifásicos.

BLONDIE 25 PARA CARRILES TRIFÁSICOS

230 V E27 42 W

R13218 cobre

€ 229

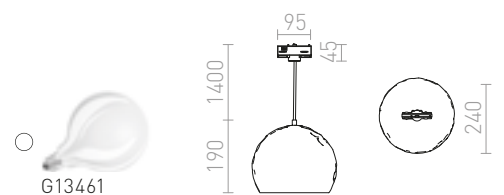



MONROE

Lámpara colgante con pantalla de color negro metálico y adaptador para carril trifásico.

MONROE 30 PARA CARRIL TRIFÁSICO

230 V E27 42 W

R12101 negro mate/blanco

€ 178

R13819 cobre

€ 138

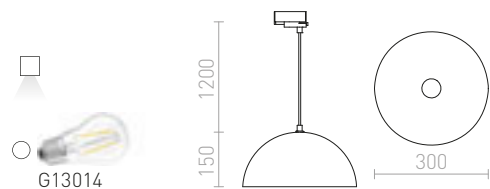



SINTRA

Lámpara colgante con pantalla de metal cromado y adaptador para carriles trifásicos.

SINTRA 30 PARA CARRIL TRIFÁSICO

230 V E27 42 W

R12102 cromo

€ 120 %

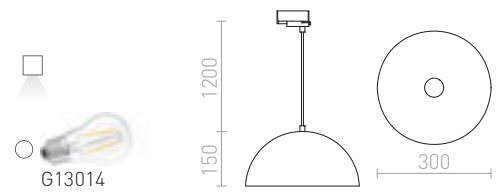

BUCKY

Colgante de metal con una pantalla de textura abollada y adaptador para carriles trifásicos.

BUCKY 40 PARA CARRIL TRIFÁSICO

230 V E27 28 W

R13859 blanco/gris/metal

€ 178

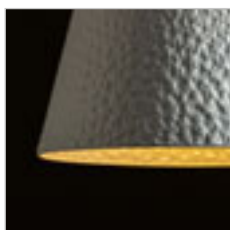
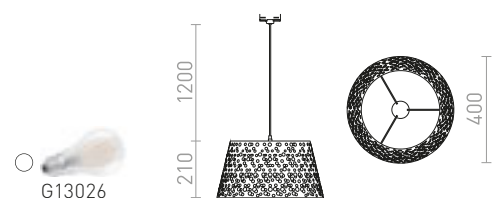



MAVRO

Elegante colgante LED en forma de tubo, adecuado para colocarse sobre barras de bar o islas de cocina. El cable va unido a un adaptador para carril trifásico.

MAVRO PARA CARRIL TRIFÁSICO COLGANTE

230 V LED 12 W $\angle 38^\circ$ 3000 K 1020 lm Ra 80

R13983 blanco

€ 150 **NEW**

R13984 oro

€ 150 **NEW**

R13985 negro/oro

€ 150 **NEW**

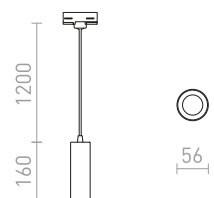



BELENOS

Colgante cilíndrico minimalista para fuente de luz GU10 sobre base redonda. Resortes unidos al zócalo permiten el uso de fuentes de luz de varias longitudes. El cable va unido a un adaptador para carriles trifásicos.

BELENOS PARA CARRIL TRIFÁSICO COLGANTE
230 V LED GU10 9 W

R13857 blanco € 88
R13858 negro € 88

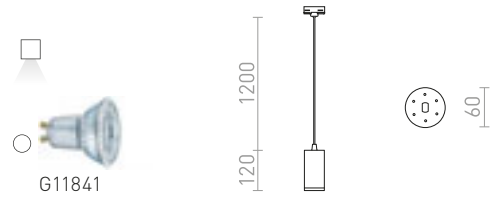

BABADES

Lámpara colgante con pantalla de cromo o níquel mate. Cable textil negro con adaptador para carriles trifásicos.

BABADES PARA CARRILES TRIFÁSICOS
230 V GU10 35 W

R13216 cromo € 88
R13217 níquel mate € 88

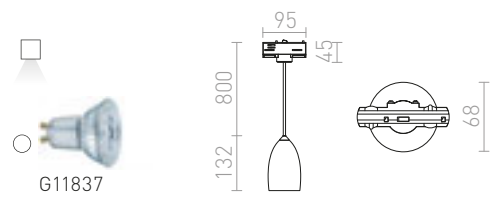

DESTY

Lámpara colgante con pantalla metálica para carriles trifásicos.

DESTY PARA CARRILES TRIFÁSICOS
230 V GU10 35 W

R13215 negro/cromo € 120

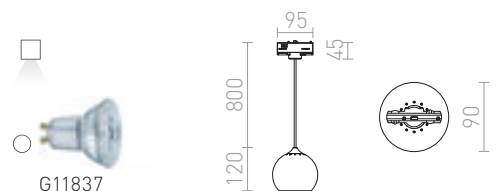



FRUTTI

Luminaria colgante con casquillo E27. El cable de alimentación se termina con un adaptador para carriles trifásicos.

FRUTTI PARA SISTEMA TRIFÁSICO

230 V E27 28 W

R13818 verde/cerámico

€ 68

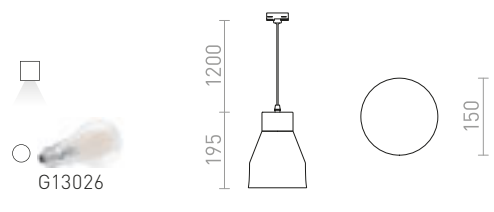

TUTTI

Luminaria de suspensión cónica que ilumina hacia abajo para la bombilla con casquillo E27. El cable de alimentación se termina con un adaptador para carriles trifásicos.

TUTTI PARA SISTEMA TRIFÁSICO

230 V E27 15 W

R13817 naranja/cerámico

€ 88

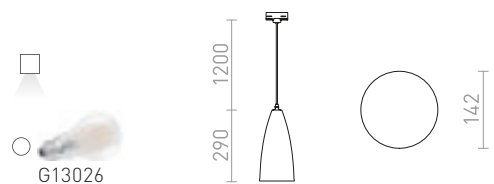

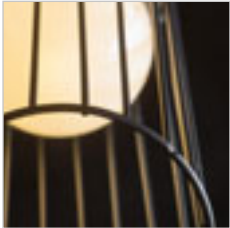

BURTON

Luminaria colgante hecha de hormigón con pantalla de hilo metálico para bombilla E27. El cable de alimentación se termina con un adaptador para carriles trifásicos.

BURTON PARA SISTEMA TRIFÁSICO

230 V E27 42 W

R13816 hormigón/negro

€ 120

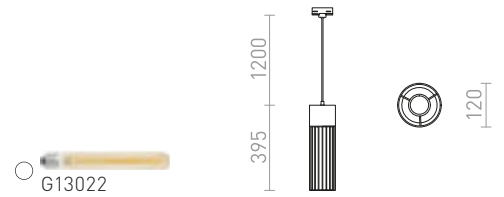

JACK

Lámpara colgante de yeso para casquillo GU10. Incluye el adaptador para carril trifásico.

JACK RC PARA CARRIL TRIFÁSICO

230 V GU10 35 W

R12103 yeso

€ 88





R12106
€ 78

R12107
€ 98

R12108
€ 78

R12109
€ 78

R12110
€ 78

R12111
€ 78

R12112
€ 88

R12113
€ 88

R12114
€ 98



ELISA

Cable textil en varias combinaciones de colores con base de metal E27, para uso con bombilla decorativa o pantalla adecuada. El cable termina con un adaptador para suspensión en carril trifásico.

ELISA PARA CARRIL TRIFÁSICO

230V E27 28 W

R12106	€ 78
R12107	€ 98
R12108	€ 78
R12109	€ 78
R12110	€ 78
R12111	€ 78
R12112	€ 88
R12113	€ 88
R12114	€ 98

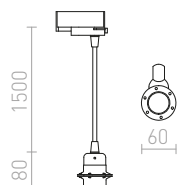

1F CARRIL

Carril monofásico para un sistema deslizante que puede estar suspendido.

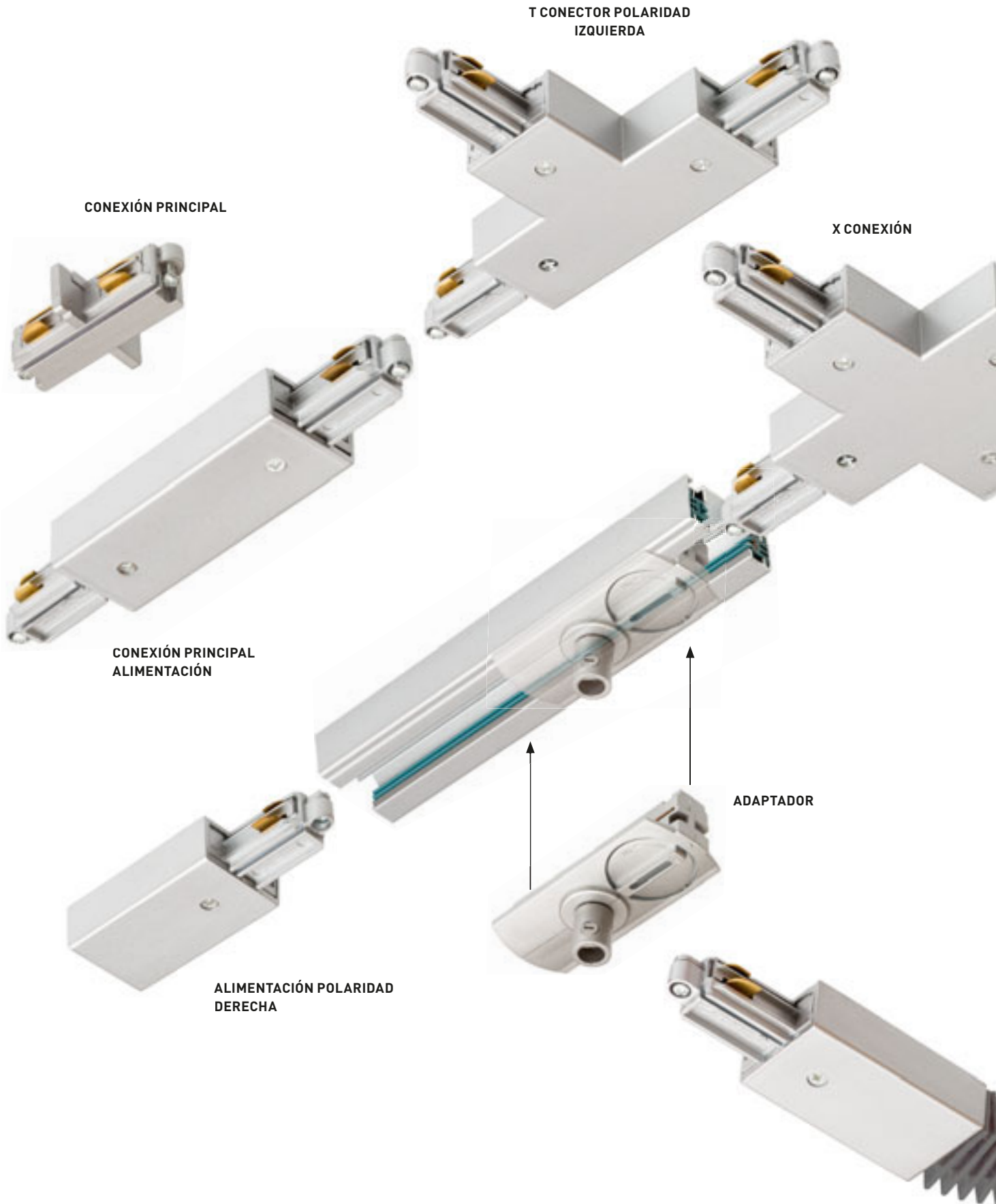

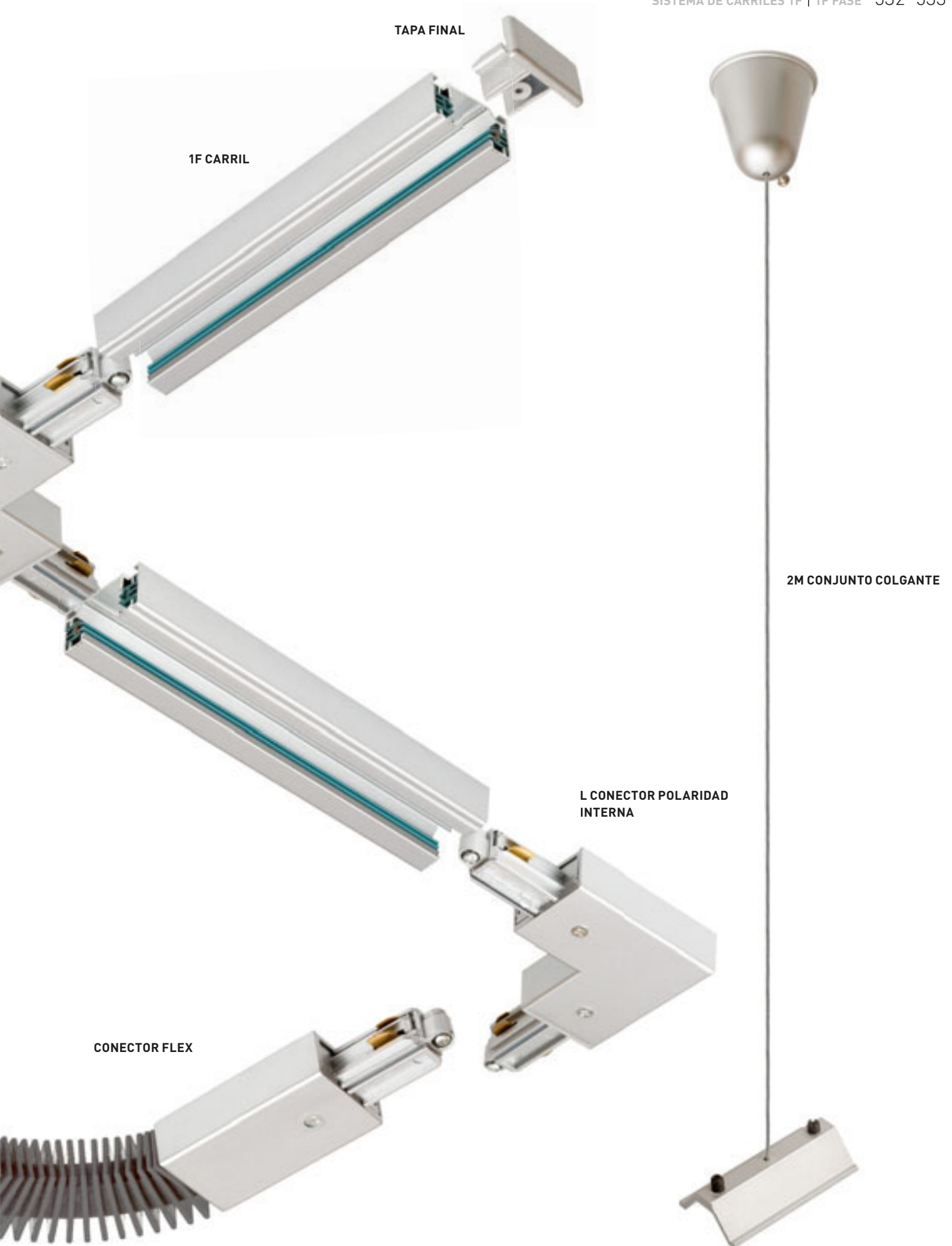

1F CARRIL

Carril monofásico para un sistema deslizante que puede estar suspendido.



2M CARRIL

Tira de un circuito para un sistema deslizante que puede suspenderse.

230 V		
R12257 blanco	€ 78.00	
R12258 negro	€ 78.00	
R12259 gris plata	€ 78.00	

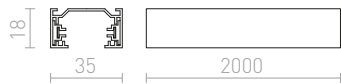

1M CARRIL

Carril monofásico para un sistema deslizante que puede estar suspendido.

230 V		
R12254 blanco	€ 38	
R12255 negro	€ 38	
R12256 gris plata	€ 38	



CONEXIÓN PRINCIPAL ALIMENTACIÓN

Conexión de energía directa. Carga máxima 16A. De un solo circuito

230 V		
R12263 blanco	€ 9.50	
R12264 negro	€ 9.50	
R12265 gris plata	€ 9.35	



X CONEXIÓN

Alimentador de X-link para carril monofásico. Carga eléctrica máxima 16A.

230 V		
R12278 blanco	€ 18.50	
R12279 negro	€ 18.50	
R12280 gris plata	€ 18	

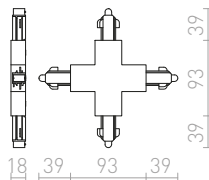

CONEXIÓN PRINCIPAL

Conexión conductiva para el riel de un solo circuito.

230 V		
R12260 blanco	€ 5.20	
R12261 negro	€ 5.35	
R12262 gris plata	€ 5.20	

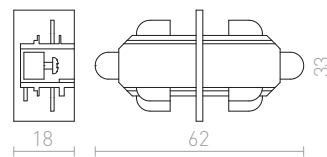

CONECTOR FLEX

Junta flexible para carril monofásico. Radio de curvatura 70° -180°. Carga máxima 16A.

230 V		
R12281 blanco	€ 16.50	
R12282 negro	€ 16.50	
R12283 gris plata	€ 17.50	

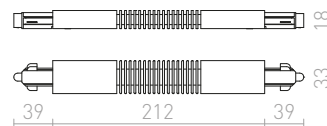



L CONECTOR POLARIDAD INTERNA

Conexión en L con fuente de alimentación para carril monofásico. Carga máxima 16 A.

- 230 V
- R12269** blanco € 10.50
- R12270** negro € 10.50
- R12271** gris plata € 9.80

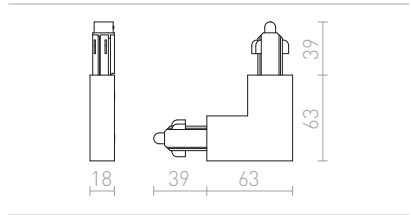

L CONECTOR POLARIDAD EXTERNA

Conexión en L con fuente de alimentación para carril monofásico. Carga máxima 16 A.

- 230 V
- R12266** blanco € 9.80
- R12267** negro € 9.80
- R12268** gris plata € 9.80

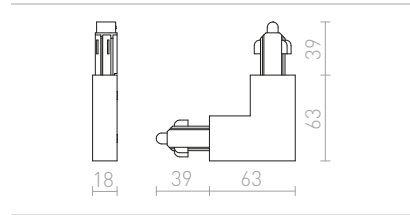

ADAPTADOR

Adaptador para carril monofásico. Con este adaptador, cualquier luz colgante con un cable simple (no se puede usar para un cable de acero y una luz de cable) se puede suspender en el sistema de riel. Carga máxima 16A. Carga mecánica máxima 20N.

- 230 V
- R12293** blanco € 9.50
- R12294** negro € 9.50
- R12295** gris plata € 9.50

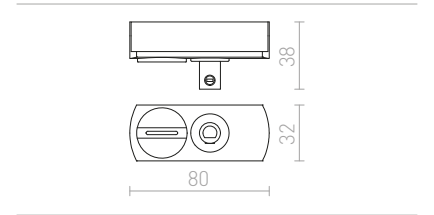

T CONECTOR POLARIDAD IZQUIERDA

Conexión T con fuente de alimentación para carril monofásico. Carga máxima 16A.

- 230 V
- R12272** blanco € 12.50
- R12273** negro € 12.50
- R12274** gris plata € 13

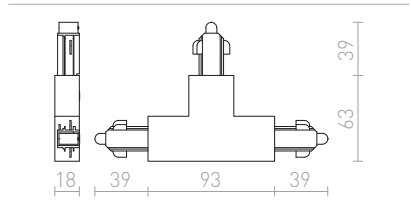

T CONECTOR POLARIDAD DERECHA

Conexión T con fuente de alimentación para barra única. Carga máxima 16A.

- 230 V
- R12275** blanco € 12.50
- R12276** negro € 13
- R12277** gris plata € 13

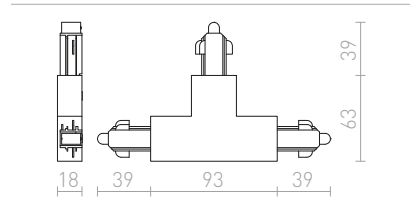

2M CONJUNTO COLGANTE

Suspensión trenzada para carril monofásico.

- R12296** blanco € 8.25
- R12297** negro € 8.25
- R12298** gris plata € 8.25

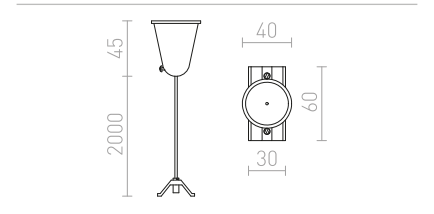

ALIMENTACIÓN POLARIDAD IZQUIERDA

Fuente de alimentación, la tapa final. Para la barra de un solo circuito. Carga eléctrica máxima 16 A.

- 230 V
- R12284** blanco € 5.20
- R12285** negro € 5.20
- R12286** gris plata € 5.20

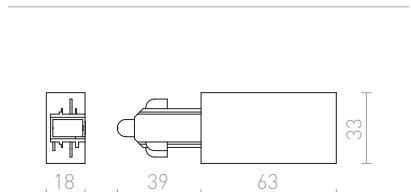

ALIMENTACIÓN POLARIDAD DERECHA

Fuente de alimentación, la tapa final. Para la barra de un solo circuito. Carga eléctrica máxima 16 A.

- 230 V
- R12287** blanco € 5.20
- R12288** negro € 5.20
- R12289** gris plata € 5.20

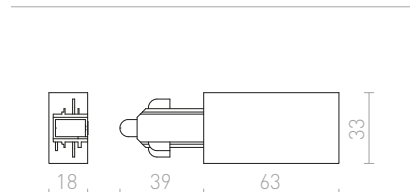

TAPA FINAL

Tapa final para carril monofásico.

- R12290** blanco € 1.35
- R12291** negro € 1.35
- R12292** gris plata € 1.35

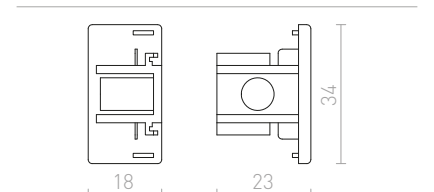



FOCUS

Proyector regulable en forma de tubo para carriles monofásicos, con capacidad de ajustar el ángulo del haz entre 10 - 60° con la llamada función de zoom. La temperatura del color de la luz puede cambiarse utilizando un interruptor en la luz: 3000K, 4000K, 5000K. Atenuación TRIAC.

FOCUS 12 DIMM PARA CARRIL MONOFÁSICO

230 V LED 12 W \angle 10-60° 3000 K 4000 K 5000 K
780 lm Ra 80

R13878 blanco

€ 88 NEW

R13879 negro

€ 88 NEW

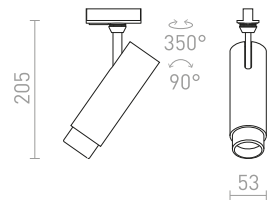
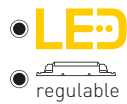

FOCUS 20 DIMM PARA CARRIL MONOFÁSICO

230 V LED 20 W \angle 10-60° 3000 K 4000 K 5000 K
1540 lm Ra 80

R13880 blanco

€ 120 NEW

R13881 negro

€ 120 NEW

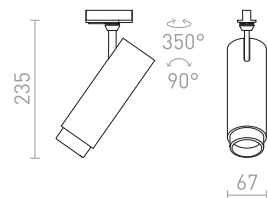



OPTIMUS

Luminaria cilíndrica para carriles monofásicos con posibilidad de ajustar el cono de luz mediante un sistema de zoom de 10-50°. La luminaria es apta para fuentes de luz LED con casquillo GU10. Recomendamos utilizar fuentes de luz con un ángulo de haz de 120° para evitar sombras no deseadas.

OPTIMUS PARA CARRILES MONOFÁSICOS

230 V LED GU10 9 W \angle 10-50°

R13781 blanco

€ 58

R13782 negro

€ 58



G12232

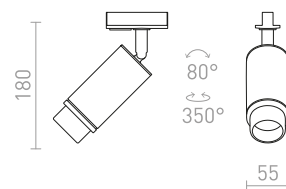



MAVRO

Foco cilíndrico con LED incorporado para carriles monofásicos. Atenuación TRIAC.

MAVRO DIMM PARA CARRIL MONOFÁSICO

230 V LED 12 W $\angle 38^\circ$ 3000 K 1020 lm Ra 80

R13163 negro/oro

€ 150

R13446 blanco

€ 150

R13849 oro

€ 150

NEW

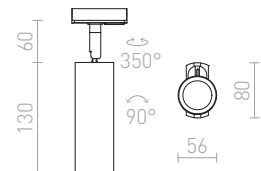

MAVRO

Foco cilíndrico con LED integrado para carriles monofásicos.

MAVRO PARA CARRIL MONOFÁSICO

230 V LED 12 W $\angle 38^\circ$ 3000 K 1020 lm Ra 80

R12993 blanco

€ 120

R12994 negro/oro

€ 120

R13848 oro

€ 120

NEW

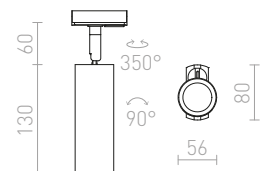



WISH

Luminaria cilíndrica regulable para carriles monofásicos con color de luz regulable: blanco cálido (WW), blanco neutro (NW), blanco frío (CW). Regulación TRIAC.

WISH 20 DIMMABLE PARA CARRILES MONOFÁSICOS

230 V LED 20 W $\angle 36^\circ$ 3000 K 4000 K 5000 K
1600 lm Ra 80

R13769 blanco

€ 98 NEW

R13770 negro

€ 98 NEW

LED

regulable

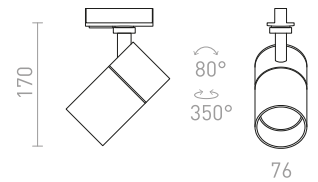

WISH 30 DIMMABLE PARA CARRILES MONOFÁSICOS

230 V LED 30 W $\angle 36^\circ$ 3000 K 4000 K 5000 K
2400 lm Ra 80

R13771 blanco

€ 120 NEW

R13772 negro

€ 120 NEW

LED

regulable

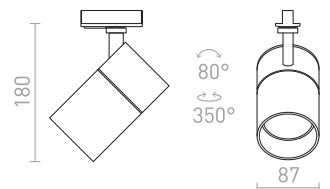



DUDE

Proyector cilíndrico con casquillo GU10 para fuentes de luz LED y adaptador para carriles monofásicos.

DUDE PARA CARRIL MONOFÁSICO

230 V LED GU10 9 W

R13926 blanco

€ 58 NEW

R13927 negro

€ 58 NEW

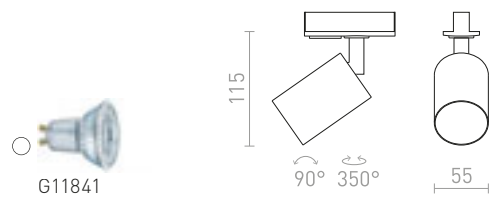

BELENOS

Foco cilíndrico minimalista con casquillo GU10 para carriles monofásicos. Los resortes del casquillo permiten el uso de fuentes de luz de varias longitudes.

BELENOS PARA CARRILES MONOFÁSICOS

230 V LED GU10 9 W

R13367 blanco

€ 68

R13369 negro

€ 68

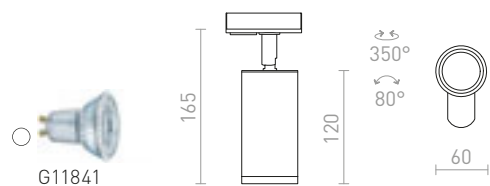



FORZA

Foco cilíndrico con casquillo GU10 para carriles monofásicos.

FORZA PARA CARRILES MONOFÁSICOS

230 V LED GU10 10 W

R13350 blanco

€ 78

R13351 negro

€ 78

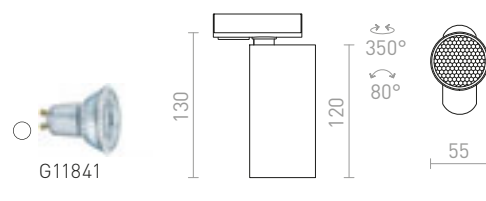

CADENZA

Foco cilíndrico con casquillo GU10 para carriles monofásicos.

CADENZA PARA CARRILES MONOFÁSICOS

230 V LED GU10 10 W

R13346 blanco

€ 68

R13347 negro

€ 68

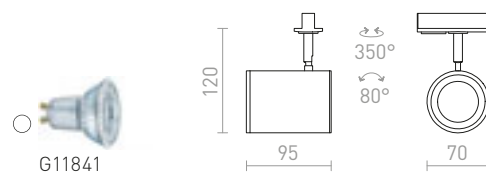



DARIO

Proyector cilíndrico con casquillo GU10 para fuentes de luz LED, incluye pantalla decorativa de latón negro cepillado. Hay diferentes combinaciones de colores disponibles comprando pantallas adicionales en otros colores. Para ser utilizado en carriles monofásicos.

DARIO PARA CARRIL MONOFÁSICO

230 V GU10 9 W

R13870 blanco/latón cepillado

€ 78

NEW

R13871 negro/latón cepillado

€ 78

NEW

R13872 latón cepillado

€ 88

NEW

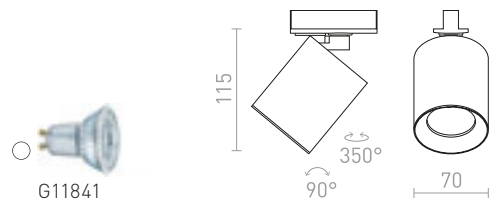
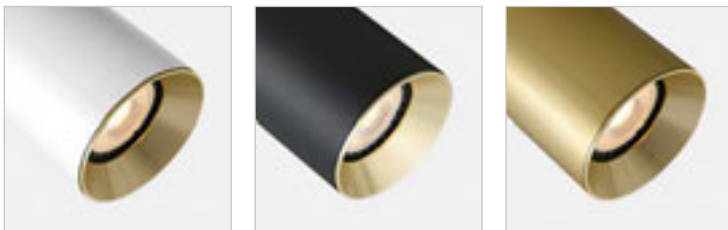

DARIO

Pantalla interior decorativa de metal en varios colores para la lampara DARIO.

DARIO ANILLO DECORATIVO

R13876 blanco

€ 8.50

NEW

R13877 negro

€ 8.50

NEW

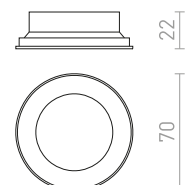
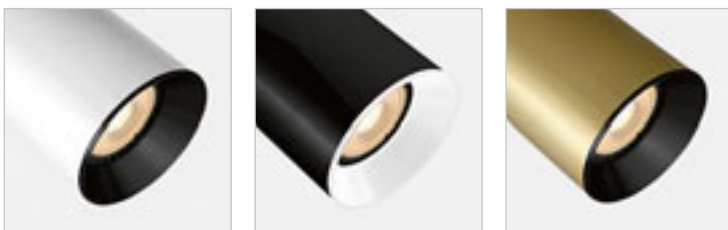



CONNOR

Foco cilíndrico con casquillo GU10 para carriles monofásicos.

CONNOR PARA CARRIL MONOFÁSICO

230 V LED GU10 10 W

R13497 blanco/negro

€ 58

R13498 negro/oro

€ 58

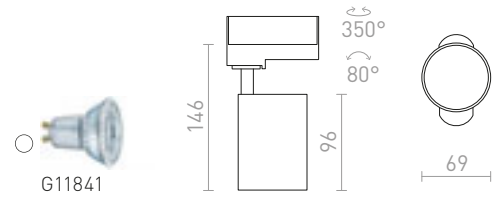

SIENA

Luminaria para carril monofásico en dos variantes de color para fuentes de luz con casquillo GU10.

SIENA PARA CARRILES MONOFÁSICOS

230 V GU10 50 W

R13759 blanco

€ 78

NEW

R13760 negro

€ 78

NEW

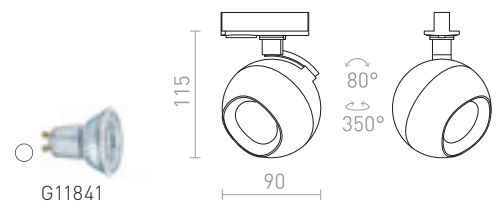

LALA

Reflector cilíndrico para carriles monofásicos para fuentes de luz con casquillo GU10.

LALA PARA CARRILES MONOFÁSICOS

230 V GU10 50 W

R13767 negro/latón

€ 58

NEW

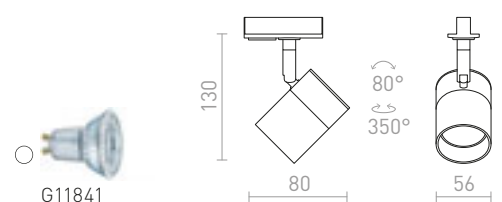



BEEBA

Luminaria para carriles monofásicos en dos variantes de color:

BEEBA I PARA CARRIL MONOFÁSICO

230 V GU10 35 W

R12308 blanco

€ 58

R12310 negro

€ 58

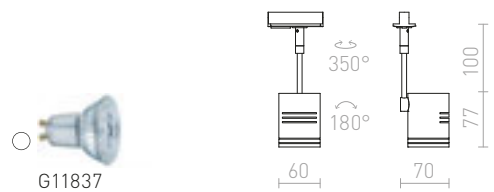

BEEBA II PARA CARRIL MONOFÁSICO

230 V GU10 2x35 W

R12314 blanco

€ 88

R12316 negro

€ 88

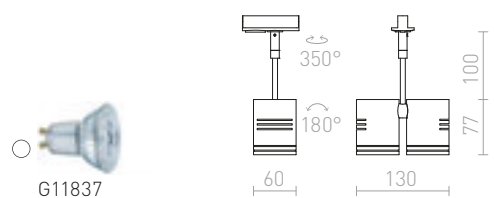



PURINA

Luminaria unilateral en tres colores. Incluye un anillo decorativo para lámparas GU10 con un diámetro del reflector de 51 mm. También se pueden usar las fuentes de luz ES111.

PURINA PARA CARRIL MONOFÁSICO

230 V GU10 50 W

R12320 blanco

€ 48

R12321 gris plata

€ 32

R12322 negro

€ 48

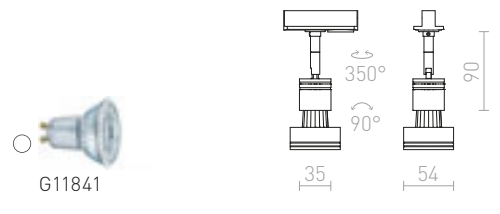

TRICA

Luminaria para sistema de carril. El producto está equipado con GU10. La fuente de luz se puede usar con un diámetro de 111 mm o 51 mm. Las dimensiones del producto son sin la fuente de luz.

TRICA PARA CARRIL MONOFÁSICO

230 V GU10 50 W

R12977 blanco

€ 29

R12978 negro

€ 29

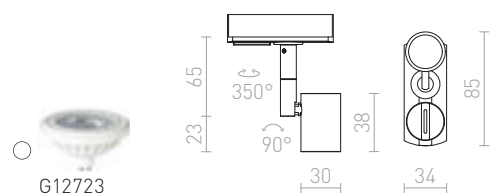



COPA

Luminaria colgante con una pantalla de vidrio para carril monofásico. Disponible en dos colores.

COPA PARA CARRILES MONOFÁSICOS

230 V E27 28 W

R13205 vidrio opal

€ 178

R13206 negro/vidrio

€ 188

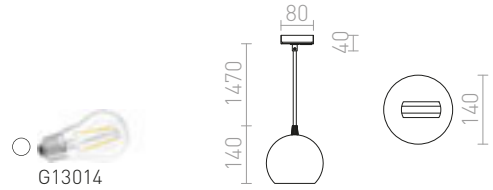

LUNA

Colgante de cristal de color ópalo con detalles en cromo y cable transparente al que se une un adaptador para carril monofásico.

LUNA 20 PARA CARRIL MONOFÁSICO

230 V LED E27 15 W

R13964 vidrio opal/cromo

€ 120

NEW

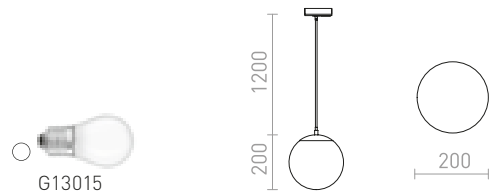

LUNA 25 PARA CARRIL MONOFÁSICO

230 V LED E27 15 W

R13965 vidrio opal/cromo

€ 178

NEW

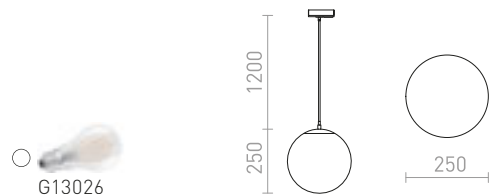

LUNA 30 PARA CARRIL MONOFÁSICO

230 V E27 15 W

R13966 vidrio opal/cromo

€ 215

NEW

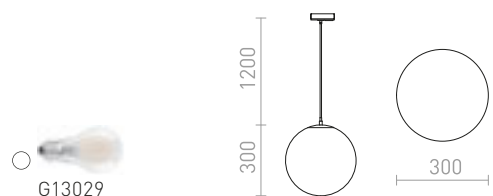





ARAQ

Colgante con casquillo de latón, cable textil y adaptador para carril monofásico. Apto para bombillas decorativas E27.

ARAQ PARA CARRIL MONOFÁSICO COLGANTE

230 V E27 42 W

R13978 latón cepillado/negro

€ 48 **NEW**

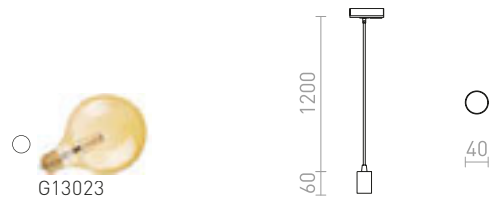

BELLINI

Luminaria colgante en vidrio con accesorios lacados para bombilla LED con csquillo E14. El cable va unido a un adaptador para carriles monofasicos.

BELLINI L E14 PARA CARRIL MONOFÁSICO COLGANTE

230 V E14 15 W

R13963 blanco/vidrio transparente

€ 188 **NEW**

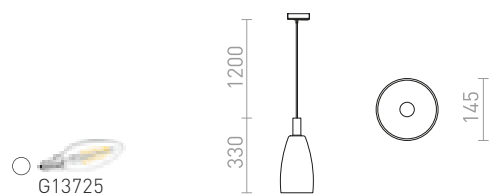



PULIRE

Lumimaria colgante de estilo retro, hecho con vidrio teñido y con un adaptador para carril monofásico.

PULIRE CON PARA CARRILES MONOFÁSICOS

230 V E14 28 W

R13209 vidrio opal/madera

€ 120

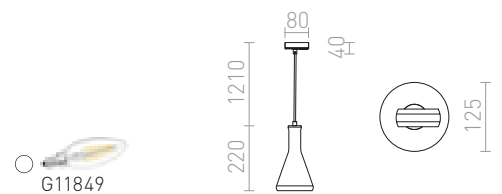

PULIRE RD PARA CARRILES MONOFÁSICOS

230 V E14 28 W

R13210 vidrio opal/madera

€ 120

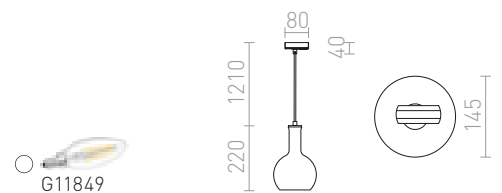



JULIETTA

Colgante con pantalla cilíndrica de color ópalo, detalles en metal lacado, cable textil negro y adaptador para carril monofásico.

JULIETTA 16 PARA CARRIL MONOFÁSICO

230 V E27 20 W

R13860 vidrio opal/negro

€ 129

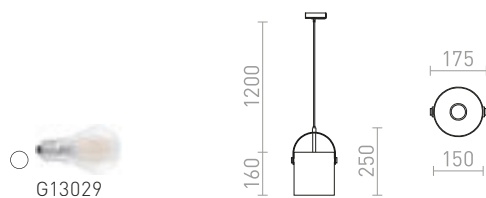

JULIETTA 31 PARA CARRIL MONOFÁSICO

230 V E27 20 W

R13861 vidrio opal/negro

€ 178

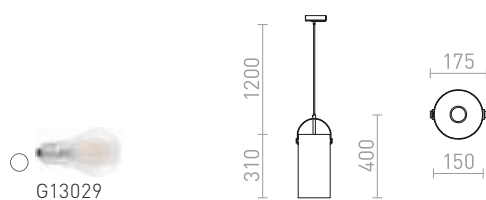



GIULIA

Lámpara colgante con pantalla de metal lacado y cable textil. El cable va unido a un adaptador para carril monofásico.

GIULIA 12 PARA CARRIL MONOFÁSICO

230 V E27 40 W

R13986 blanco/cromo

€ 68 NEW

R13987 negro/dourado cinza/latón

€ 68 NEW

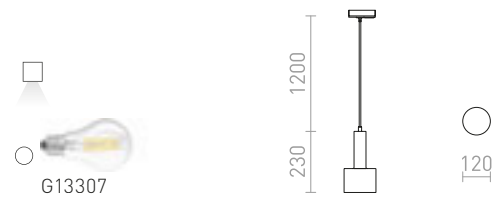

GIULIA 20 PARA CARRIL MONOFÁSICO

230 V E27 40 W

R13988 blanco/cromo

€ 78 NEW

R13989 negro/dourado cinza/latón

€ 88 NEW

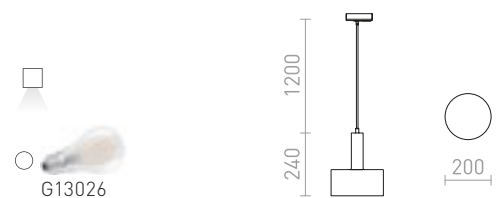



CHOUPETTE

Luminaria textil suspendida con accesorio de madera para bombilla LED con casquillo E27 para instalación en carril monofásico.

CHOUPETTE PARA VÍAS DE UN CIRCUITO

230 V E27 15 W

R13720 gris negrozco/textil/madera

€ 129

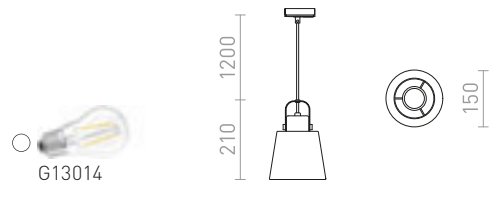

BABADES

Lámpara colgante con pantalla de cromo o níquel mate. Cable textil negro con adaptador para carriles monofásicos.

BABADES PARA CARRILES MONOFÁSICOS

230 V GU10 35 W

R13212 cromo

€ 68

R13213 níquel mate

€ 68

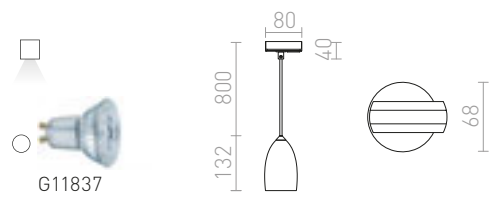

ICAR

Colgante minimalista con pantalla textil. Cable textil negro con adaptador para carril monofásico.

ICAR PARA CARRILES MONOFÁSICOS

230 V E27 15 W

R13214 negro/oro

€ 120 →

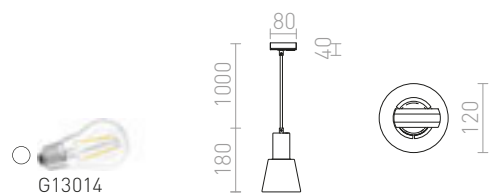



MAVRO

Elegante colgante LED en forma de tubo, adecuado para colocarse sobre barras de bar o islas de cocina. El cable va unido a un adaptador para carril monofásico.

MAVRO PARA CARRIL MONOFÁSICO COLGANTE
230 V LED 12 W $\angle 38^\circ$ 3000 K 1020 lm Ra 80

R13980 blanco

€ 120

NEW

R13981 oro

€ 120

NEW

R13982 negro/oro

€ 120

NEW

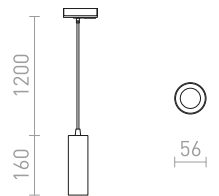

BELENOS

Colgante cilíndrico minimalista para fuente de luz GU10 sobre base redonda. Resortes unidos al zócalo permiten el uso de fuentes de luz de varias longitudes. El cable va unido a un adaptador para carriles monofásicos.

BELENOS PARA CARRIL MONOFÁSICO COLGANTE
230 V LED GU10 9 W

R13862 blanco

€ 68

R13863 negro

€ 68



G11841

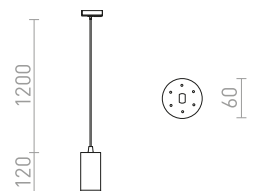



AGNETA

Colgante redondo de metal para usar con una fuente de luz E27. El cable va unido a un adaptador para carril monofásico.

AGNETA PARA CARRIL MONOFÁSICO COLGANTE

230 V E27 40 W

R13970 blanco	€ 68	NEW
R13971 negro	€ 68	NEW
R13972 latón cepillado	€ 98	NEW
R13973 cobre cepillado	€ 98	NEW

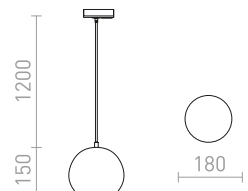



DESTY

Lámpara colgante con pantalla metálica para carriles monofásicos.

DESTY PARA CARRILES MONOFÁSICOS

230 V GU10 35 W

R13211 negro/cromo

€ 88

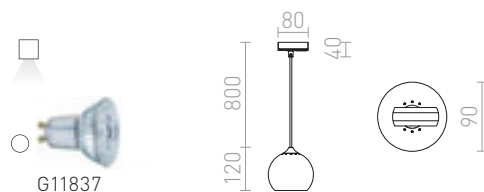

BLONDIE

Colgante con pantalla de metal dentado. El exterior de la pantalla es de color cobre y el interior es blanco laqueado. Suministrado con cable PVC negro con adaptador para carril monofásico.

BLONDIE 25 PARA CARRIL MONOFÁSICO

230 V E27 42 W

R13726 cobre

€ 215

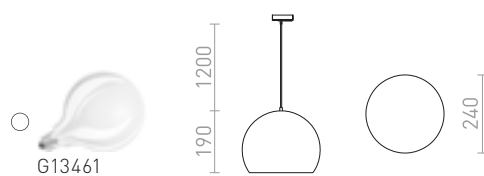

ELISA

Cable textil en varios colores y combinaciones con base de metal E27, para uso con bombilla de diseño o pantalla adecuada. El cable termina con un adaptador para suspensión en carril monofásico.

ELISA PARA CARRIL MONOFÁSICO

230 V E27 28 W

R13201

€ 58

R13202

€ 58

R13203

€ 58

R13204

€ 68

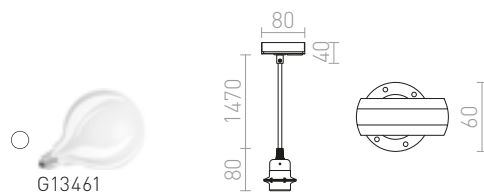

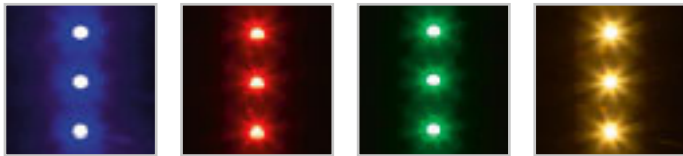

BANDA DE LED ORION

Tira de LED RGBW que se puede configurar en diferentes colores o en blanco con varias temperaturas de color (3000K - 450lm/m). Viene en una longitud de 5 m que se puede cortar cada 5 cm y tiene una cinta adhesiva de doble cara en la parte posterior. Es necesario agregar el controlador y el controlador LED adecuados, los cuales se venden por separado. Recomendamos comprar nuestro controlador G13804, que está probado y verificado y permite el control de la tira de LED por control remoto (incluido en el paquete G13804), así como también mediante el uso de Amazon Alexa, Google Assistant o con aplicaciones como Smart Life y Tuya Smart.

LED STRIP ORION RGBW TIRA LED 5M

12V= LED 96 W $\angle 120^\circ$ RGBW up to 2250 lm Ra 80

G13820

€ 58



5000x12 mm

BANDA DE LED ORION

Tira de LED RGB con la capacidad de cambiar de color que viene en longitudes de 5 m y que se pueden cortar cada 5 cm. La tira tiene una cinta adhesiva de doble cara en la parte posterior. Es necesario agregar el controlador y el controlador LED adecuados y se venden por separado. Recomendamos comprar nuestro controlador G13804, que está probado y verificado y permite el control de la tira de LED por control remoto (incluido en el paquete G13804), mediante el uso de Amazon Alexa, Google Assistant o con aplicaciones como Smart Life y Tuya Smart.

LED STRIP ORION RGB TIRA LED 5M

12V= LED 72 W $\angle 120^\circ$ RGB 2250 lm Ra 80

G13800

€ 38 →



5000x10 mm

LED STRIP ORION CONTROLADOR WI-FI 5EN1

Controlador Wi-Fi 5 en 1. Las tiras de LED se pueden controlar mediante las aplicaciones Amazon Alexa, Google Assistant o Smart Life o Tuya Smart. La unidad de control solo funciona a una frecuencia de 2,4 GHz. El paquete también incluye un control remoto separado. El controlador Wi-Fi se puede utilizar para controlar las tiras de LED RGB o para atenuar las tiras de LED de un solo color G13798, G13799.

G13804

€ 24

**LED STRIP ORION 60 DRIVER**

Driver LED 60W 12V para alimentar tiras LED.

230 V/12 V= 60 W IP67

G13801**€ 22**

25x202x35 mm

**LED STRIP ORION 100 DRIVER**

Driver LED 100W 12V para alimentar tiras LED.

230 V/12 V= 100 W IP67

G13802**€ 29**

35x178x53 mm

**LED STRIP ORION 150 DRIVER**

Driver LED 150W 12V para alimentar tiras LED. Driver tiene dos terminales secundarios.

230 V/12 V= 150 W IP67

G13803**€ 48**

33x199x61 mm

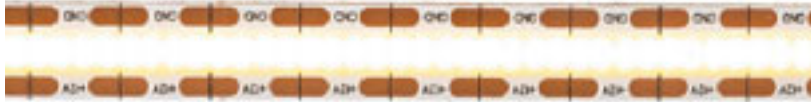

BANDA DE LED ORION

Tira LED COB de alto rendimiento. La tira tiene un brillo uniforme en toda su longitud, sin manchas visibles. Se suministra en longitudes de 5 m que se pueden cortar cada 0,75 cm y tiene una cinta adhesiva de doble cara en la parte posterior. Es necesario agregar un controlador adecuado, el cual se vende por separado. La tira se puede atenuar usando el control remoto G13804. 3000K - 950lm/m; 4000K - 1000lm/m

LED STRIP ORION TIRA LED 5M

12V= LED 50 W $\angle 120^\circ$ 3000 K 2375 lm Ra 80

G13798

€ 58



5000x8 mm

LED STRIP ORION TIRA LED 5M

12V= LED 50 W $\angle 120^\circ$ 4000 K 2500 lm Ra 80

G13799

€ 58



5000x8 mm



LED STRIP ORION CONTROLADOR WI-FI 5EN1

Controlador Wi-Fi 5 en 1. Las tiras de LED se pueden controlar mediante las aplicaciones Amazon Alexa, Google Assistant o Smart Life o Tuya Smart. La unidad de control solo funciona a una frecuencia de 2,4 GHz. El paquete también incluye un control remoto separado. El controlador Wi-Fi se puede utilizar para controlar las tiras de LED RGB o para atenuar las tiras de LED de un solo color G13798, G13799.

G13804

€ 24

**LED STRIP ORION 60 DRIVER**

Driver LED 60W 12V para alimentar tiras LED.

230 V/12 V= 60 W IP67

G13801**€ 22**

25x202x35 mm

**LED STRIP ORION 100 DRIVER**

Driver LED 100W 12V para alimentar tiras LED.

230 V/12 V= 100 W IP67

G13802**€ 29**

35x178x53 mm

**LED STRIP ORION 150 DRIVER**

Driver LED 150W 12V para alimentar tiras LED. Driver tiene dos terminales secundarios.

230 V/12 V= 150 W IP67

G13803**€ 48**

33x199x61 mm



LED STRIP IP20 5M

Tira de LED adecuado para iluminación interior decorativa. Suministrado en envase de 5 metros, divisible cada 5 cm, con una cinta adhesiva con nervaduras en la espalda. La cinta está disponible en versiones de luz caliente o fría. Necesita la adición de un transformador y un conector.

12 V= LED 60 W 5000 lm Ra 80

G12366 3000 K

€ 14

G12367 4000 K

€ 14



G13802



5000x8 mm



LED STRIP IP20 ALIMENTACIÓN

Accesorios para LED STRIP IP20 G12366 y G12367.

G12370

€ 0.50



150 mm

LED STRIP IP20 CONEXIÓN

Accesorios para LED STRIP IP20 G12366 y G12367.

G12368

€ 0.80



165 mm

LED STRIP IP20 CONEXIÓN PRINCIPAL

Accesorios para LED STRIP IP20 G12366 y G12367.

G12369

€ 0.40



5x16x13 mm

LED STRIP FUENTE DE ALIMENTACIÓN

Fuente de alimentación para cintas LED 12V =.
230 V/12V= 72 W

G12377

€ 22



42x100x160 mm



LED STRIP IP54 5M

Tira de LED adecuada para iluminación decorativa en ambientes húmedos. Se suministra en un paquete de 5 metros, divisible por 5 cm, con una cinta adhesiva con nervaduras en la parte posterior. La cinta está disponible en versiones de luz fría o caliente. Necesita la adición de un transformador y conector.

12 V= LED 60 W 5000lm Ra 80 IP54

- G12371** 3000 K **€ 24**
- G12372** 4000 K **€ 24**



G13802 5000x8 mm

LED STRIP IP54 ALIMENTACIÓN

Accesorios para LED STRIP IP54 G12371 y G12372.

- G12375** **€ 0.70**



150 mm

LED STRIP IP54 CONEXIÓN

Accesorios para LED STRIP IP54 G12371 y G12372.

- G12373** **€ 1.20**



165 mm

LED STRIP IP54 CONEXIÓN PRINCIPAL

Accesorios para LED STRIP IP54 G12371 y G12372.

- G12374** **€ 0.50**



8x15x14 mm

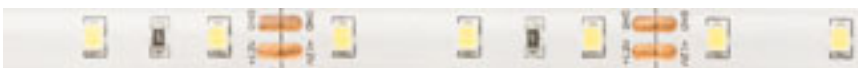
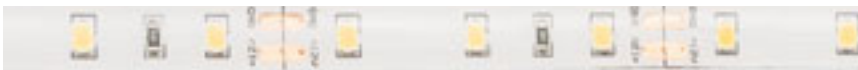

IP54

LED STRIP ATENUADOR CON MANDO A DISTANCIA

Control remoto para cintas LED 12V = intensidad de luz ajustable. Adecuado para cintas LED G12366, G12367, G12371 o G12372.

12 V= max. 108 W

- G12378** blanco **€ 48**



G13802 103x54x6 mm



LED PROFIL

Perfil de aluminio de superficie montada para colocar una tira LED adecuada. Se suministra con un difusor mate y accesorios.

LED PROFILE G MONTADAS EN SUPERFICIE 1M

R14086	blanco/acrílico mate/aluminio	€ 24	NEW
R14087	negro/acrílico mate/aluminio	€ 24	NEW
R14088	aluminio anodizado/acrílico mate	€ 18	NEW

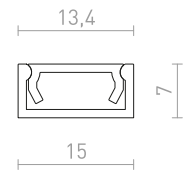

LED PROFIL

Perfil de aluminio de superficie montada para colocar una tira LED adecuada. Se suministra con un difusor mate y accesorios.

LED PROFILE H MONTADAS EN SUPERFICIE 1M

R14089	blanco/acrílico mate/aluminio	€ 35	NEW
R14090	negro/acrílico mate/aluminio	€ 35	NEW
R14091	aluminio anodizado/acrílico mate	€ 29	NEW

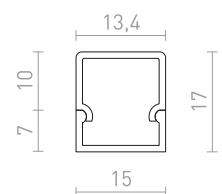

LED PROFIL

Perfil de aluminio asimétrico de esquina para colocar una tira de LED adecuada. Dependiendo del método de montaje, la luz saldrá en un ángulo de 30° o 60°. Se suministra con un difusor mate y accesorios.

LED PROFILE I 30/60 MONTADAS EN SUPERFICIE 1M

R14092	aluminio anodizado/acrílico mate	€ 26	NEW
--------	----------------------------------	------	-----

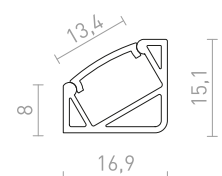



LED PROFIL

Perfil de esquina de aluminio para colocar tiras de LED adecuadas. Se pueden colocar hasta tres tiras LED de 8 mm de ancho o dos tiras LED de 12 mm de ancho. Se suministra con un difusor mate y accesorios.

LED PROFILE J MONTADAS EN SUPERFICIE 1M

R14093 blanco/acrílico mate/aluminio	€ 120	NEW
R14094 negro/acrílico mate/aluminio	€ 120	NEW
R14095 aluminio anodizado/acrílico mate	€ 98	NEW

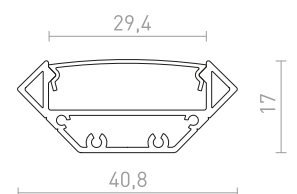



LED PROFIL

Perfil de aluminio para uso con tira de LED adecuada. Incluye un difusor mate y accesorios.

LED PROFILE A EMPOTRADA 1M

R13864 aluminio/acrílico esmerilado € 26

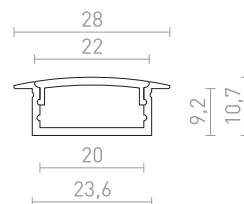

↑ 9
 1000x24

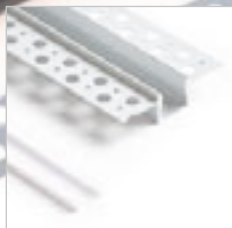
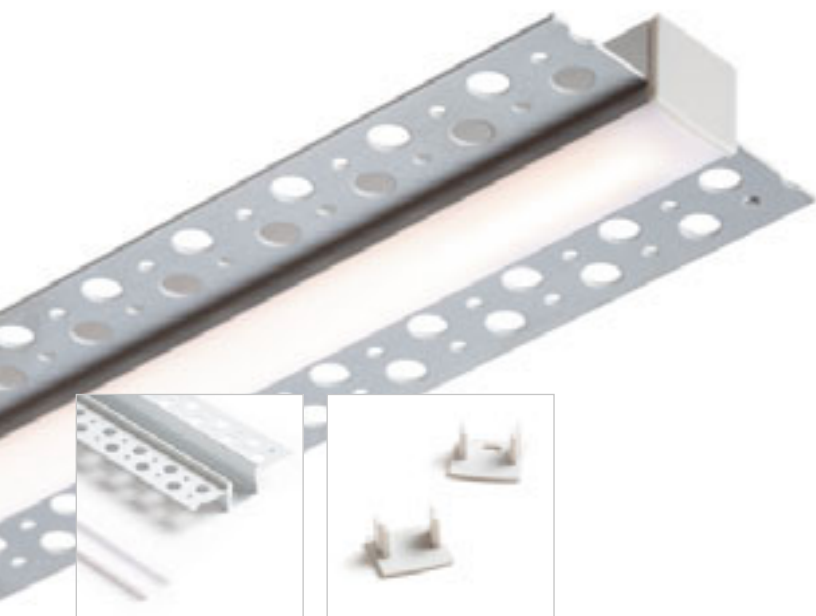

LED PROFIL

Perfil de aluminio para uso con tira de LED adecuada. Incluye un difusor mate y accesorios. Adecuado para ser empotrado en paredes de paneles de yeso.

LED PROFILE B EMPOTRADA 1M

R13865 aluminio/acrílico esmerilado € 48

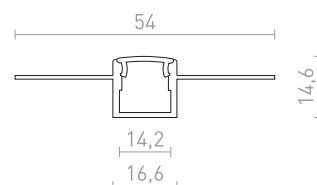

↑ 14
 1000x17





LED PROFIL

Perfil de aluminio para uso con tira de LED adecuada. Incluye un difusor mate y accesorios.

LED PROFILE D MONTADAS EN SUPERFICIE 1M

R13866 aluminio/acrílico esmerilado

€ 32

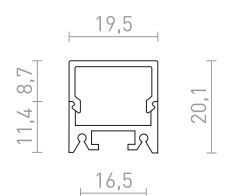



PANTALLAS Y ACCESORIOS

PANTALLAS COLGANTES	572-573
PANTALLAS DE MESA/DE PIE	574-577
PANTALLAS UNIVERSALES	578-593
SET COLGANTE	594-607
SOPORTES/BASES	608-617
CABLES	618-619



PANTALLAS Y ACCESORIOS PANTALLAS COLGANTES



ASPRO 40/30
572-573



ASPRO 55/30
572-573



DAISY
572-573

572-573



BEAT 38
572-573

PANTALLAS Y ACCESORIOS PANTALLAS DE MESA/DE PIE



CONNYS 15/15
574-575



CONNYS 15/30
574-575

574-577



CONNYS 25/30
574-575



CONNYS 35/30
574-575



ALVIS 24/15
576-577



AMBITUS 30/21
576-577



AMBITUS 46/24
576-577



NIZZA 18/15
576-577

PANTALLAS Y ACCESORIOS PANTALLAS UNIVERSALES



RIDICK
578-579



ILLUSION 45/33
578-579

578-593



JAKARANDA 40
578-579



DELISA 25/16
580-581



DELISA 35/30
580-581



RON 60/19
582-583



RON 55/30
582-583



RON 15/20
584-585



RON 40/25
584-585



DOUBLE 40/30
586-587



DOUBLE 55/30
586-587



TEMPO 30/19
588-589



TEMPO 50/19
588-589



TEMPO 15/15
590-591



TEMPO 15/30
590-591



CASUAL 90/22
590-591



CASUAL 120/25
590-591



LOPE 80/23
592-593



LOPE 120/22
592-593

PANTALLAS Y ACCESORIOS SET COLGANTE



MORE 60
594-595

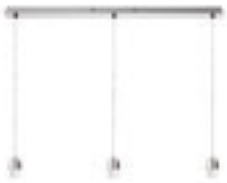

MORE 80
594-595



RALLONG IV
594-595



RALLONG IV
594-595



RALLONG V
594-595



RALLONG V
594-595



KOMBIX 2
596-597



KOMBIX 3
596-597



KOMBIX 6
596-597



HEX
598-599



ELISA
600-601



FABIO
602-603



LISA
602-603



ENZO
602-603



SOLO SQ
604-605



SOLO R
604-605



POSTE
604-605



TRIX
604-605



SPIDER I
606-607

PANTALLAS Y ACCESORIOS SOPORTES/BASES

608-617



BEND
608-609



HUDSON
608-609



WOODY
610-611



NIZZA 18/15
610-611



NIZZA
610-611



AMBITUS
612-613



AMBITUS
612-613



ALVIS
612-613



ALVIS
612-613



KEITH
614-615



MAUI
614-615



LUTON
614-615



NYC TRIPOD
614-615



NYC
616-617



NYC
616-617



CORTINA
616-617



CORTINA
616-617

PANTALLAS Y ACCESORIOS CABLES

618-619



FIT 3x0,75 4m
618-619



FIT 3x0,75
618-619



FIT 3x0,75
618-619

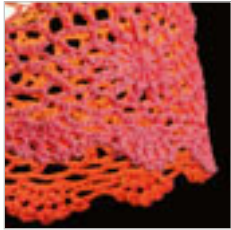

DAISY

Pantalla colgante de ganchillo. Accesorios adecuados: ELISA, ENZO, HEX, LISA.

DAISY PANTALLA PARA COLGANTE

max. 15 W

R13278 rosa

€ 29 %

R13279 blanco/gris luminoso

€ 29 %

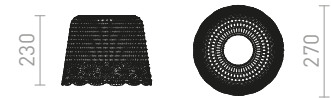

BEAT

Pantalla sólida acolchada de imitación cuero.

BEAT 38 PANTALLA PARA COLGANTE

max. 28 W

R13281 negro

€ 48 %





ASPRO

Pantalla textil con casquillo E27. Adecuada para la instalación en conjunto colgante. El difusor de PMMA (R11867) se puede pedir para la pantalla. Adecuada para accesorios: HEX, ELISA, ENZO, KOMBIX, LISA, POSTE, TRIX.

ASPRO 55/30 PANTALLA

max 23 W

	R11466 polialgodón negro/hoja dorada	€ 248
	R11482 polialgodón negro/hoja de cobre	€ 248
	R11494 polialgodón blanco/PVC blanco	€ 120
	R11577 monaco gasolina azul/plata PVC	€ 229
	R11588 monaco paloma gris/plata PVC	€ 229

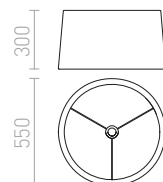

ASPRO

Pantalla textil con casquillo E27. Adecuada para la instalación en conjunto colgante. El difusor de PMMA (R11867) se puede solicitar para la pantalla. Accesorios adecuados: HEX, ELISA, ENZO, KOMBIX, LISA, POSTE, TRIX.

ASPRO 40/30 PANTALLA

max 23 W

	R11467 polialgodón negro/hoja dorada	€ 178
	R11483 polialgodón negro/hoja de cobre	€ 178
	R11495 polialgodón blanco/PVC blanco	€ 120
	R11578 monaco gasolina azul/plata PVC	€ 188
	R11589 monaco paloma gris/plata PVC	€ 188

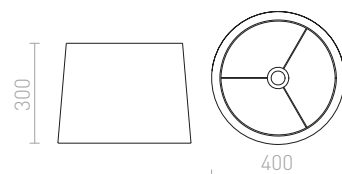



CONNY

Pantalla textil para bombilla E27, apropiada para ser instalada en una base de mesa. Accesorios adecuados: CORTINA, NYC, NYC TRIPOD, WOODY.

CONNY 25/30 PANTALLA DE MESA

max. 23 W

	R11371 polialgodón negro/hoja de cobre	€ 129
	R11497 polialgodón blanco/PVC blanco	€ 68
	R11580 monaco gasolina azul/plata PVC	€ 120
	R11591 monaco paloma gris/plata PVC	€ 120
	R11597 polialgodón negro/hoja dorada	€ 129

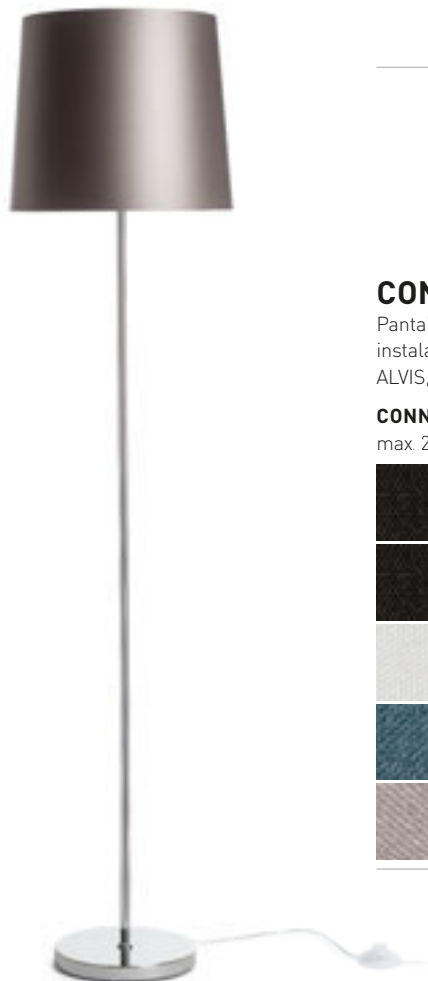
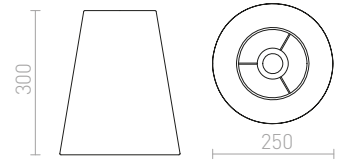

CONNY

Pantalla textil para bombilla E27, apropiada para ser instalada en una base de soporte. Accesorios adecuados: ALVIS, AMBITUS, CORTINA, NYC, NYC TRIPOD, WOODY.

CONNY 35/30 PANTALLA DE PIE

max. 23 W

	R11372 polialgodón negro/hoja de cobre	€ 178
	R11469 polialgodón negro/hoja dorada	€ 178
	R11498 polialgodón blanco/PVC blanco	€ 88
	R11581 monaco gasolina azul/plata PVC	€ 178
	R11592 monaco paloma gris/plata PVC	€ 178

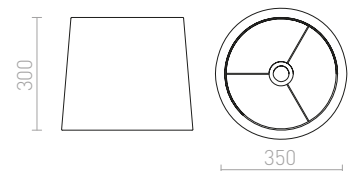



CONNY

Pantalla textil para bombilla E27, apropiada para ser instalada en una base de mesa. Accesorios adecuados: ALVIS, AMBITUS, CORTINA, NYC.

CONNY 15/15 PANTALLA

max 28 W

	R11800 polialgodón blanco/PVC blanco	€ 68
---	--	-------------

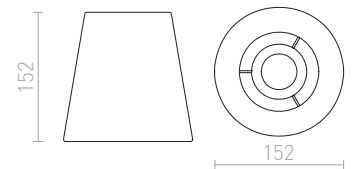

CONNY

Pantalla textil para bombilla E27, apropiada para ser instalada en una base de mesa. Accesorios adecuados: CORTINA, NYC.

CONNY 15/30 PANTALLA DE MESA

max 23 W

	R11370 polialgodón negro/hoja de cobre	€ 88
	R11468 polialgodón negro/hoja dorada	€ 98
	R11496 polialgodón blanco/PVC blanco	€ 68
	R11579 monaco gasolina azul/plata PVC	€ 98
	R11590 monaco paloma gris/plata PVC	€ 98

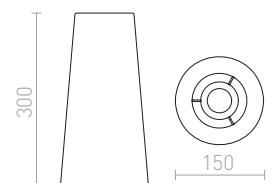



AMBITUS

Pantalla textil con base para casquillo E27, adecuada para bases de lámparas de mesa: ALVIS, AMBITUS, CORTINA, MAUI, NYC, WOODY.

AMBITUS 30/21 PANTALLA DE MESA
max. 28 W

R13841 polialgodón blanco

€ 68 NEW

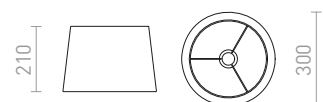



NIZZA

Pantalla textil para casquillo E27, adecuada para instalar en conjuntos colgantes y lámparas de mesa R12947.

NIZZA 18/15 PANTALLA

max 28 W

R13113 polialgodón blanco/PVC blanco

€ 58

R13114 polialgodón negro/PVC blanco

€ 58

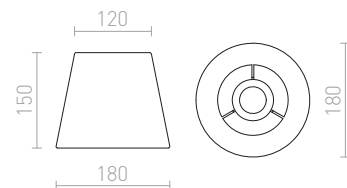

ALVIS

Pantalla de textil para casquillo E27. Bases para lámpara de mesa adecuadas: ALVIS, CORTINA, MAUI, NYC, WOODY.

ALVIS 24/15 PANTALLA DE MESA

max 28 W

R13524 blanco crema

€ 48

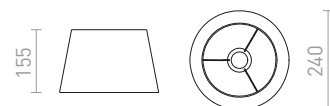

AMBITUS

Pantalla textil con base para casquillo E27. Adecuada para bases de lámparas de pie: ALVIS, AMBITUS, CORTINA, NYC, NYC TRIPOD.

AMBITUS 46/24 PANTALLA LÁMPARA DE PIE

max 28 W

R13526 blanco crema

€ 98

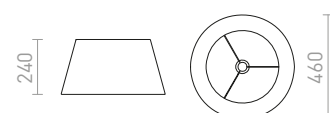



RIDICK

Pantalla decorativa negra con un interior dorado, que se puede combinar con un juego de colgantes o una base de lámpara de pie. Accesorios adecuados: HEX, ELISA, ENZO, LISA, KOMBIX, BEND, ALVIS, AMBITUS, NYC.

RIDICK PANTALLA

max. 20 W

R13344 negro brillante/hoja dorada

€ 68 →

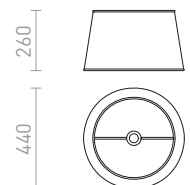

ILLUSION

Pantalla decorativa de papel de aluminio cromado, que se puede combinar con un juego colgante o una base de lámpara de pie. Cuando se enciende la lámpara, se vuelve semitransparente y cuando se apaga tiene una superficie reflectante. Accesorios adecuados: HEX, ELISA, ENZO, LISA, KOMBIX, BEND, ALVIS, AMBITUS, NYC.

ILLUSION 45/33 PANTALLA

max. 20 W

R13417 hoja de cromo

€ 98 →

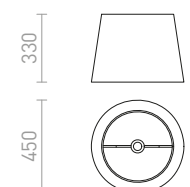

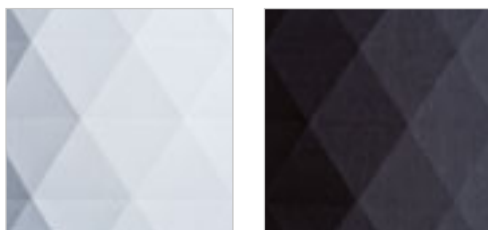

JAKARANDA

Pantalla textil separada con superficie 3D geométrica. Para usar con un juego colgante o un soporte para el casquillo E27. Accesorios adecuados: HEX, ELISA, ENZO, KOMBIX, LISA, AMBITUS, ALVIS, CORTINA.

JAKARANDA 40 PANTALLA

max 28 W

R12392 blanco

€ 120

R12393 negro

€ 120

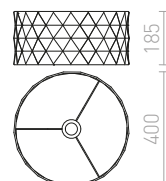





DELISA

Pantalla decorativa adornada con botones de colores. Adecuada para bases colgantes o de pie. Accesorios adecuados: HEX, ELISA, ENZO, LISA, KOMBIX, AMBITUS, ALVIS, CORTINA.

DELISA 35/30 PANTALLA

max 28 W

R12389 blanco/botones

€ 78

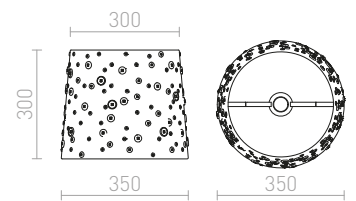

DELISA

Pantalla decorativa adornada con botones de colores. Puede ser usada como lámpara colgante o de mesa. Accesorios adecuados: HEX, ELISA, ENZO, KOMBIX, LISA, AMBITUS, ALVIS, CORTINA.

DELISA 25/16 PANTALLA

max 28 W

R12388 blanco/botones

€ 35

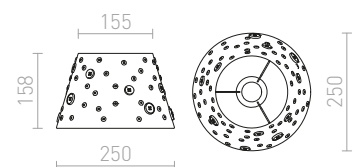



DIFFUSER

Difusor circular para pantallas textiles.

DIFFUSER R 60 PMMA

G11869 acrílico esmerilado

€ 32

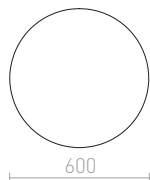

RON

Pantalla textil para casquillo E27 que se instalará en una base en techo o conjunto colgante. Se puede pedir el difusor de PMMA (R11869, R12301) pero no es adecuado para R11452. Accesorios adecuados: HEX, ELISA, ENZO, LISA, POSTE, TRIX.

RON 60/19 PANTALLA

max. 23 W

	R11462 polialgodón negro/hoja dorada	€ 178
	R11479 polialgodón negro/hoja de cobre	€ 178
	R11490 polialgodón blanco/PVC blanco	€ 120
	R11517 Chintz naranja/PVC blanco	€ 98
	R11546 menta de Chintz/hoja de plata	€ 188
	R11555 Chintz gris claro/PVC blanco	€ 98
	R11565 Chintz lima/PVC blanco	€ 98
	R11573 monaco gasolina azul/plata PVC	€ 188
	R11584 monaco paloma gris/plata PVC	€ 188
	R11607 albaricque Chintz/PVC blanco	€ 98
	R13052 polialgodón negro/PVC blanco	€ 120

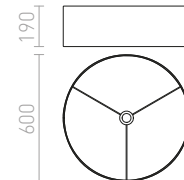



DIFFUSER

Difusor circular para pantallas textiles.

DIFFUSER R 55 PMMA

G11868 acrílico esmerilado

€ 29

G12300 claro

€ 32

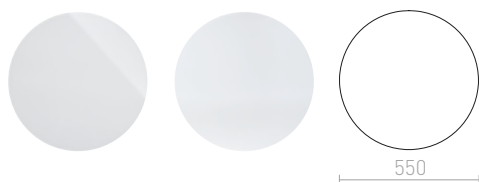

RON

Pantalla textil para casquillo E27. Adecuada para instalación sobre bases en techo, conjuntos colgante o bases de soporte. Accesorios adecuados: HEX, ELISA, ENZO, LISA, POSTE, TRIX, KOMBIX. Se puede solicitar un difusor de PMMA (R11868, R12300).

RON 55/30 PANTALLA

max. 23 W

	R11463 polialgodón negro/hoja dorada	€ 220
	R11480 polialgodón negro/hoja de cobre	€ 220
	R11491 polialgodón blanco/PVC blanco	€ 120
	R11518 Chintz naranja/PVC blanco	€ 98
	R11556 Chintz gris claro/PVC blanco	€ 98
	R11566 Chintz lima/PVC blanco	€ 98
	R11574 monaco gasolina azul/plata PVC	€ 188
	R11585 monaco paloma gris/plata PVC	€ 188
	R11608 albaricoque Chintz/PVC blanco	€ 98
	R13051 polialgodón negro/PVC blanco	€ 120

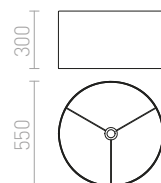



DIFFUSER

Difusor circular para pantallas textiles.

DIFFUSER R 40 PMMA

G11867 acrílico esmerilado

€ 17.50

G12299 claro

€ 19.50



RON

Pantalla textil para casquillo E27. Adecuada para instalación sobre bases en techo, conjuntos colgante o bases de soporte. Se puede pedir el difusor de PMMA (R11867, R12299) pero no es adecuado para R11455.

Accesorios adecuados: SOLO, HEX, ELISA, ENZO, LISA, KOMBIX, AMBITUS, ALVIS, CORTINA, NYC, NYC TRIPOD, WOODY.

RON 40/25 PANTALLA

max 23 W

	R11465 polialgodón negro/hoja dorada	€ 138
	R11481 polialgodón negro/hoja de cobre	€ 138
	R11493 polialgodón blanco/PVC blanco	€ 88
	R11510 albaricoque Chintz/PVC blanco	€ 78
	R11520 Chintz naranja/PVC blanco	€ 78
	R11549 menta de Chintz/hoja de plata	€ 138
	R11558 Chintz gris claro/PVC blanco	€ 78
	R11568 Chintz lima/PVC blanco	€ 78
	R11576 monaco gasolina azul/plata PVC	€ 138
	R11587 monaco paloma gris/plata PVC	€ 138
	R13050 polialgodón negro/PVC blanco	€ 88

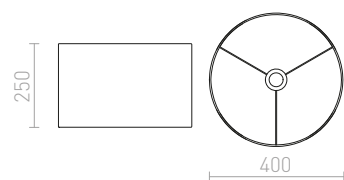



RON

Pantalla textil para casquillo E27. Adecuada para instalación sobre bases en techo, conjuntos colgante o soportes de mesa como: HEX, ELISA, ENZO, KOMBIX, LISA, MORE, CORTINA, NYC.

RON 15/20 PANTALLA

max. 28 W

	R11802 polialgodón negro/hoja dorada	€ 98
	R11803 polialgodón negro/hoja de cobre	€ 98
	R11804 polialgodón blanco/PVC blanco	€ 68
	R11805 albaricoque Chintz/PVC blanco	€ 68
	R11806 Chintz naranja/PVC blanco	€ 68
	R11809 Chintz lima/PVC blanco	€ 68
	R11810 monaco paloma gris/plata PVC	€ 88
	R11811 monaco gasolina azul/plata PVC	€ 88
	R13049 polialgodón negro/PVC blanco	€ 68

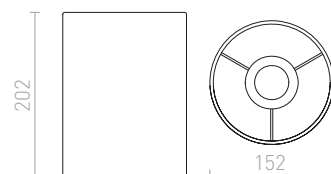



DIFFUSER

Difusor circular para pantallas textiles.

DIFFUSER R 55 PMMA

G11868 acrílico esmerilado

€ 29

G12300 claro

€ 32



DOUBLE

Pantalla textil para E27. Instalación en el techo o conjunto colgante. Se puede solicitar un difusor de PMMA (R11868, R12300) para la cortina. Accesorios adecuados: HEX, ELISA, ENZO, KOMBIX, LISA, POSTE, TRIX.

DOUBLE 55/30 PANTALLA

max. 23 W

	R11477 polialgodón negro/hoja dorada	€ 215
	R11478 polialgodón negro/hoja de cobre	€ 215
	R11508 albaricoque Chintz/PVC blanco	€ 120
	R11516 Chintz naranja/PVC blanco	€ 120
	R11545 menta de Chintz/hoja de plata	€ 215
	R11554 Chintz gris claro/PVC blanco	€ 120
	R11564 Chintz lima/PVC blanco	€ 120
	R11600 polialgodón blanco/PVC blanco	€ 138

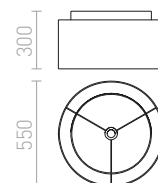



DIFFUSER

Difusor circular para pantallas textiles.

DIFFUSER R 40 PMMA

G11867 acrílico esmerilado

€ 17.50

G12299 claro

€ 19.50



DOUBLE

Pantalla textil para E27. Instalación en el techo o conjunto colgante. El difusor de PMMA (R11867, R12299) se puede pedir para la cortina. Accesorios adecuados: HEX, ELISA, ENZO, KOMBIX, LISA.

DOUBLE 40/30 PANTALLA

max 23 W

	R11461 polialgodón negro/hoja dorada	€ 178
	R11507 albaricoque Chintz/PVC blanco	€ 120
	R11515 Chintz naranja/PVC blanco	€ 120
	R11535 aceituna de Chintz/hoja de plata	€ 120 %
	R11544 menta de Chintz/hoja de plata	€ 215
	R11553 Chintz gris claro/PVC blanco	€ 120
	R11563 Chintz lima/PVC blanco	€ 120
	R11599 polialgodón blanco/PVC blanco	€ 129

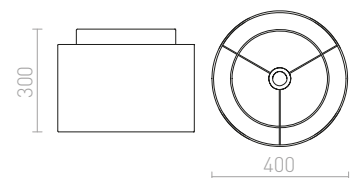



DIFFUSER

Difusor cuadrado para pantallas textiles.

DIFFUSER SQ 50 PMMA

G11871 acrílico esmerilado

€ 32

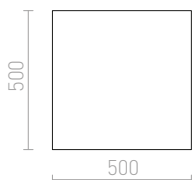

TEMPO

Pantalla textil para casquillo E27 que puede ser instalada en una base de techo o conjunto colgante. El difusor de PMMA (R11871) se puede solicitar para la pantalla. Accesorios adecuados: HEX, ELISA, ENZO, KOMBIX, LISA, NYC.

TEMPO 50/19 PANTALLA

max. 23 W

	R11475 polialgodón negro/hoja dorada	€ 178
	R11488 polialgodón negro/hoja de cobre	€ 178
	R11505 polialgodón blanco/PVC blanco	€ 98
	R11513 albaricoque Chintz/PVC blanco	€ 48 %
	R11523 Chintz naranja/PVC blanco	€ 48 %
	R11542 aceituna de Chintz/hoja de plata	€ 48 %
	R11551 menta de Chintz/hoja de plata	€ 48 %
	R11561 Chintz gris claro/PVC blanco	€ 78

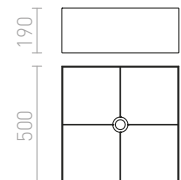



DIFFUSER

Difusor cuadrado para pantallas textiles.

DIFFUSER SQ 30 PMMA

G11870 acrílico esmerilado

€ 18

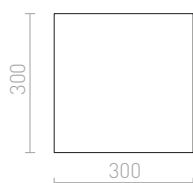

TEMPO

Pantalla textil para casquillo E27 para ser instalada en una base de techo, conjunto de suspensión o base de soporte. Se puede solicitar un difusor de PMMA (R11870) para la cortina. Accesorios adecuados: SOLO, HEX, ELISA, ENZO, KOMBIX, LISA, NYC.

TEMPO 30/19 PANTALLA

max 23 W

	R11476 polialgodón negro/hoja dorada	€ 129
	R11489 polialgodón negro/hoja de cobre	€ 129
	R11506 polialgodón blanco/PVC blanco	€ 78
	R11514 albaricoque Chintz/PVC blanco	€ 48 %
	R11524 Chintz naranja/PVC blanco	€ 48 %
	R11543 aceituna de Chintz/hoja de plata	€ 48 %
	R11552 menta de Chintz/hoja de plata	€ 48 %
	R11562 Chintz gris claro/PVC blanco	€ 38 %

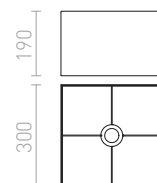



TEMPO

Pantalla textil para bombilla E27, para ser instalada en conjuntos colgantes o base de mesa. Accesorios adecuados: HEX, ELISA, ENZO, KOMBIX, LISA, MORE, NYC.

TEMPO 15/30 PANTALLA

max 28 W



R11822
polialgodón blanco/PVC blanco

€ 78

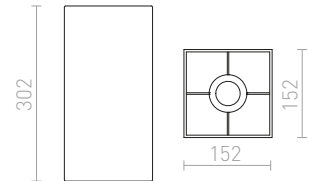

TEMPO

Pantalla textil para casquillo E27, adecuada para ser instalada en conjuntos colgantes o base de mesa, p. ej.: HEX, ELISA, ENZO, KOMBIX, LISA, MORE, NYC

TEMPO 15/15 PANTALLA

max 28 W



R11812
polialgodón negro/hoja dorada

€ 88



R11813
polialgodón negro/hoja de cobre

€ 88



R11814
polialgodón blanco/PVC blanco

€ 58



R11815
albaricoque Chintz/PVC blanco

€ 58



R11816
Chintz naranja/PVC blanco

€ 58



R11817
Chintz terracota/PVC blanco

€ 29

%

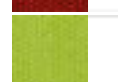

R11819
Chintz lima/PVC blanco

€ 58



R11820
monaco gasolina azul/plata PVC

€ 88

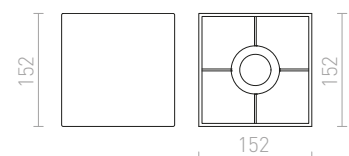



CASUAL

Pantalla textil para la instalación en una base de techo R11797 o conjunto colgante R11798.

CASUAL 120/25 PANTALLA

max 23 W

	R11471 polialgodón negro/hoja dorada	€ 329
	R11484 polialgodón negro/hoja de cobre	€ 329
	R11500 polialgodón blanco/PVC blanco	€ 178
	R11582 monaco gasolina azul/plata PVC	€ 278
	R11593 monaco paloma gris/plata PVC	€ 278

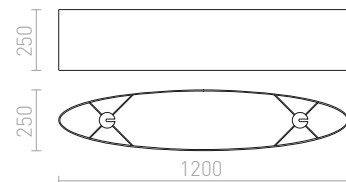

CASUAL

Pantalla textil para la instalación en una base de techo R11795 o conjunto colgante R11796.

CASUAL 90/22 PANTALLA

max 23 W

	R11472 polialgodón negro/hoja dorada	€ 248
	R11485 polialgodón negro/hoja de cobre	€ 248
	R11501 polialgodón blanco/PVC blanco	€ 178
	R11583 monaco gasolina azul/plata PVC	€ 215
	R11594 monaco paloma gris/plata PVC	€ 215

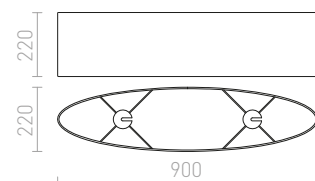





LOPE

Pantalla textil adecuada para la instalación en una base de techo R11797 o conjunto colgante R11798.

LOPE 120/22 PANTALLA

max. 23 W

	R11473 polialgodón negro/hoja dorada	€ 320
	R11486 polialgodón negro/hoja de cobre	€ 320
	R11502 polialgodón blanco/PVC blanco	€ 178
	R11611 albaricoque Chintz/PVC blanco	€ 88 %
	R11616 Chintz naranja/PVC blanco	€ 88 %
	R11634 Chintz gris claro/PVC blanco	€ 88 %
	R11639 Chintz lima/PVC blanco	€ 88 %

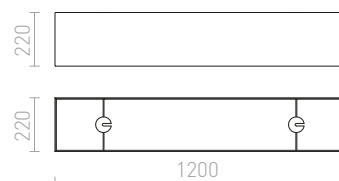



LOPE

Pantalla textil adecuada para la instalación en una base de techo R11795 o conjunto colgante R11796.

LOPE 80/23 PANTALLA

max 23 W

	R11474 polialgodón negro/hoja dorada	€ 178
	R11487 polialgodón negro/hoja de cobre	€ 88 %
	R11503 polialgodón blanco/PVC blanco	€ 138
	R11511 albaricoque Chintz/PVC blanco	€ 35 %
	R11541 aceituna de Chintz/hoja de plata	€ 88 %
	R11550 menta de Chintz/hoja de plata	€ 88 %
	R11559 Chintz gris claro/PVC blanco	€ 48 %
	R11569 Chintz lima/PVC blanco	€ 35 %

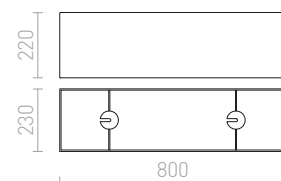



MORE

Base lineal de techo en diseño brillante y mate con una longitud de 60 u 80 cm para colgar tres pantallas. Adecuada para pantallas: RON 15/20, TEMPO 15/15, TEMPO 15/30.

MORE 80 BASE DE TECHO COLGANTE

230 V E27 3x42 W

R11776 níquel mate

€ 58

%

R11777 cromo

€ 58

%



G13026

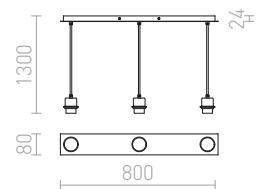

MORE 60 BASE DE TECHO COLGANTE

230 V E27 3x42 W

R11774 níquel mate

€ 48

%

R11775 cromo

€ 48

%



G13026

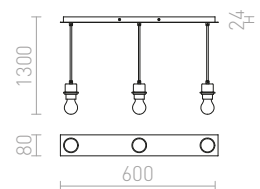

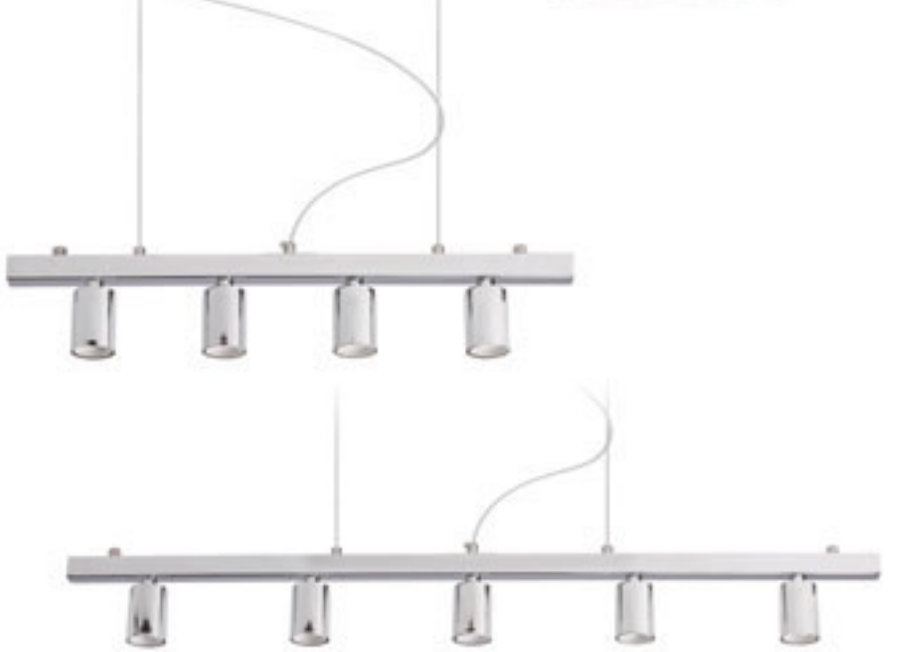

RALLONG

Conjunto colgante para pantallas textiles longitudinales. RALLONG 4 se puede combinar con pantallas CASUAL 90 y LOPE 80. RALLONG 5 se puede combinar con pantallas CASUAL 120 y LOPE 120.

RALLONG IV BASE COLGANTE

230 V E27 4x42 W

R11796 cromo

€ 68

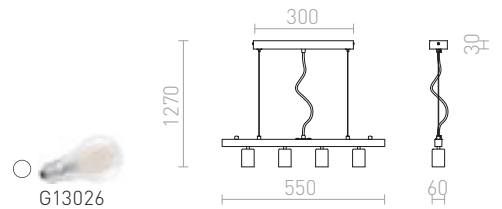

RALLONG V BASE COLGANTE

230 V E27 5x42 W

R11798 cromo

€ 68

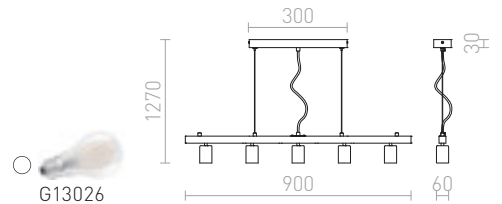

RALLONG IV BASE DE TECHO

230 V E27 4x42 W

R11795 cromo

€ 32

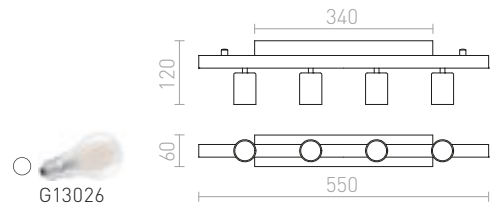

RALLONG V BASE DE TECHO

230 V E27 5x42 W

R11797 cromo

€ 48

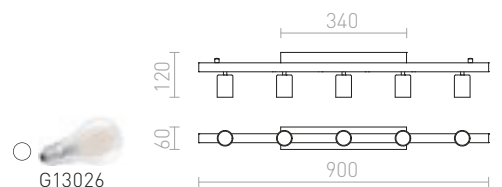

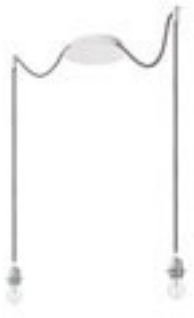

R11778
€ 178

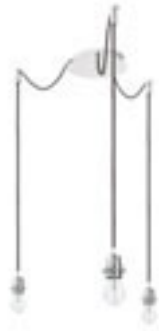

R11779
€ 229



R11780
€ 380



R11781
€ 158



R11782
€ 215



R11783
€ 335



R11787
€ 150



R11788
€ 215



R11789
€ 335



R11784
€ 158



R11785
€ 215



R11786
€ 398



R11778 + R11563



R11783 + R11810



KOMBIX

Luminaria colgante con base de techo central y cuerdas textiles individuales con base de metal E27, para usar con lámparas decorativas o pantallas textiles adecuadas. Las cuerdas de suspensión están equipadas con agarraderas de techo de cromo, que se pueden colocar a una distancia individual de la base. Longitud total de cuerda de suspensión 3 m.

KOMBIX 2 SET COLGANTE

230 V E27 2x28 W

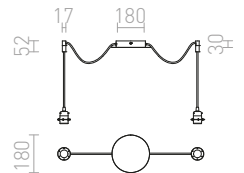

KOMBIX 3 SET COLGANTE

230 V E27 3x28 W

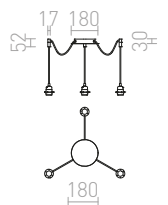

KOMBIX 6 SET COLGANTE

230 V E27 6x28 W

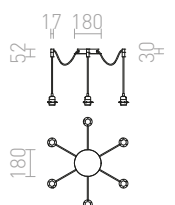



R11915
€ 58



R11914
€ 58



R11910
€ 58



R11911
€ 58



R11932
€ 68



R11943
€ 58



R11930
€ 58



R11938
€ 68



R11920
€ 58



R11918
€ 58



R11940
€ 68



HEX

Conjunto de suspensión con base decorativa, base metálica E27 y cable textil. Adecuado para uso separado o suspensión de pantallas ligeras. Adecuado para pantallas: DOUBLE 40/30, DOUBLE 55/30, ASPRO 40/30, ASPRO 55/30, KARO 55/15, KARO 80/20, RON 40/25, RON 55/30, RON 60/19, TEMPO 30/19, TEMPO 50/19.

HEX SET COLGANTE

230 V E27 28 W

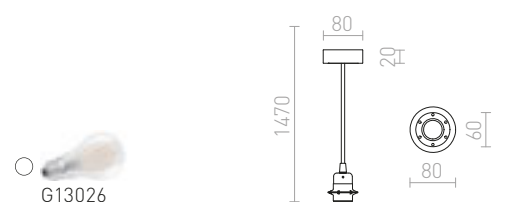



R11879
€ 48



R11886
€ 48



R11880
€ 48



R11892
€ 48



R11884
€ 48



R11888
€ 48



R11877
€ 48



R11891
€ 48



R11875
€ 48



R11896
€ 48



R11876
€ 48



R11894
€ 48



R11906
€ 48



R11885
€ 48



R11883
€ 48



R11882
€ 48



R11881
€ 48



R11889
€ 48



R11872
€ 48



R11887
€ 48



R11890
€ 48



R11874
€ 48



R11873
€ 48



R11878
€ 48



R11908
€ 48



R11897
€ 48



R11895
€ 48



R11893
€ 48



R11898
€ 48



R11905
€ 48



R11904
€ 48



R11903
€ 58



R11907
€ 48



R11900
€ 48



R11902
€ 58



R11901
€ 58



R11899
€ 48

ELISA

Conjunto colgante, con base de techo circular, cable textil y base de metal E27. Adecuado para uso independiente o para colgar pantallas ligeras. Adecuado para pantallas: DOUBLE 40/30, DOUBLE 55/30, ASPRO 40/30, ASPRO 55/30, KARO 55/15, KARO 80/20, KARO 80/30, RON 40/25, RON 55/30, RON 60/19, TEMPO 30/19, TEMPO 50/19.

ELISA SET COLGANTE

230 V E27 28 W

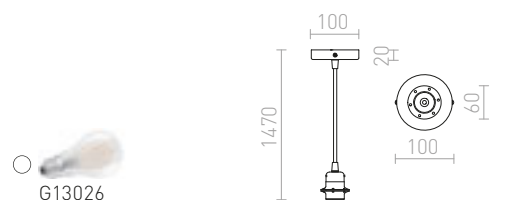



G12246

FABIO

Conjunto de suspensión elegante, con tapa para techo de porcelana y base E27 colgada en cable textil. Adecuado para uso independiente solamente con bombilla decorativa. Dimensiones del casquillo de cerámica: Ø/V 4.5/6 cm.

FABIO CONJUNTO DE SUSPENSIÓN

230 V E27 42 W

R10617 negro/blanco/porcelana

€ 32 %

R10618 negro/porcelana

€ 32 %

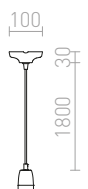



LISA

Juego colgante con cable textil, funda de silicona para base E27 y tapa de plástico para techo. Adecuado para pantallas: ARISTA, DELI, DELISA, JAKARANDA, DOUBLE 40/30, DOUBLE 55/30, ASPRO 40/30, ASPRO 55/30, KARO 55/15, KARO 80/20, RON 15/20, RON 40/25, RON 55/30, RON 60/19, TEMPO 15/15, TEMPO 15/30, TEMPO 30/19, TEMPO 50/19.

LISA CONJUNTO DE SUSPENSIÓN

230 V E27 42 W

R10622 rojo	€ 18.50	%
R10623 verde	€ 9.35	%
R10624 blanco	€ 24	
R10625 negro	€ 24	

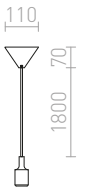

ENZO

Conjunto colgante con elementos cromados, cable transparente y conector E27. Adecuado para pantallas: ARISTA, DELI, DELISA, JAKARANDA, DOUBLE 40/30, DOUBLE 55/30, ASPRO 40/30, ASPRO 55/30, KARO 55/15, KARO 80/20, RON 15/20, RON 40/25, RON 55/30, RON 60/19, TEMPO 15/15, TEMPO 15/30, TEMPO 30/19, TEMPO 50/19.

ENZO CONJUNTO DE SUSPENSIÓN

230 V E27 42 W

R10616 cromo	€ 28
---------------------	-------------

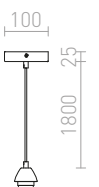



SOLO

Base circular de techo para pantallas textiles con casquillo E27. Pantallas adecuadas: DELI 30/20, DOUBLE 40/30, JAKARANDA, RON 40/25, TEMPO 30/19.

SOLO SQ BASE DE TECHO

230 V E27 53 W

R12584 cromo

€ 28

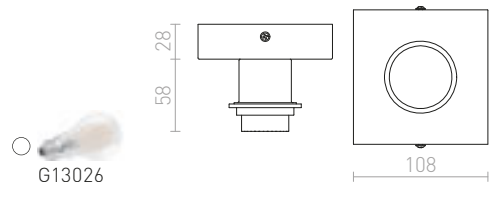

SOLO R BASE DE TECHO

230 V E27 53 W

R12583 cromo

€ 28

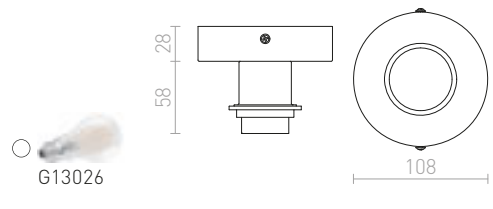

POSTE

Base de techo cromada con tres casquillos ajustables E27. Adecuado para pantallas textiles de más de 30 cm. Adecuado para pantallas: DELI 55/30, DOUBLE 55/30, RON 55/30, RON 60/19, TEMPO 50/19.

POSTE BASE DE TECHO

230 V E27 3x20 W

R11799 cromo

€ 68

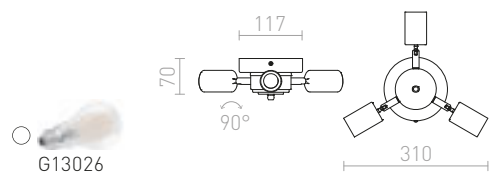



TRIX

Conjunto de suspensión con tres casquillos inclinables a 90°. Pantallas adecuadas: DOUBLE 55/30, ASPRO 55/30, KARO 55/15, KARO 80/20, RON 55/30, RON 60/19, TEMPO 50/19.

TRIX CONJUNTO DE SUSPENSIÓN

230 V E27 3x42 W

R10615 cromo

€ 98

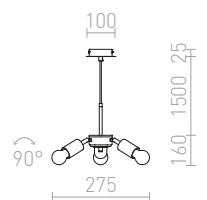



SPIDER

Una solución flexible para ser complementada con una fuente de luz decorativa o para colgar pantallas ligeras. Puede ser instalada en paredes o techos con agarres a lo largo de un cable textil negro. El conjunto está disponible con 4 soportes de plástico negro o cromado. Los soportes adicionales pueden ser pedidos por separado. Pantallas adecuadas: ARISTA, ASPRO, DOUBLE, JAKARANDA, RON.

SPIDER I CONJUNTO DE SUSPENSIÓN

230 V E27 15 W

R13492 negro

€ 58

R13493 negro/cromo

€ 78

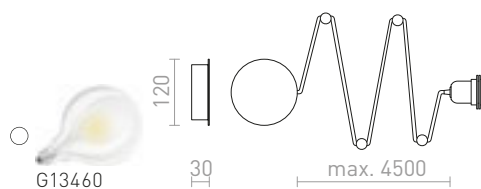



SPIDER

Soportes de cables de repuesto para el juego SPIDER R13492 y R13493.

SPIDER SOPORTE

R13494 negro/plástico

€ 2.20

R13495 cromo/metal

€ 5.80

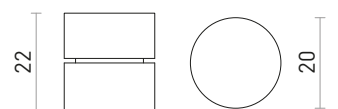





HUDSON

Aplique de pared con brazo cromado y cable vertical, acabado con pantalla cilíndrica textil.

HUDSON DE PARED

230 V E27 28 W

R13284 blanco/cromo

€ 138

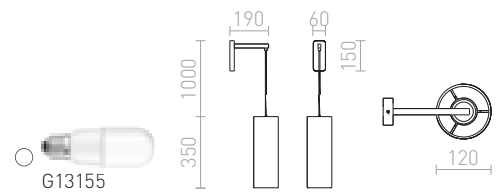

BEND

Base de pared en diseño de níquel con cable de alimentación a la toma. Apropiado para pantallas textiles con casquillo E27. El interruptor está ubicado en el cable de alimentación. Accesorios adecuados: RON 40/25, ASPRO 40/30.

BEND BASE DE ARCO DE PARED

230 V E27 42 W

R12654 níquel mate

€ 150

%

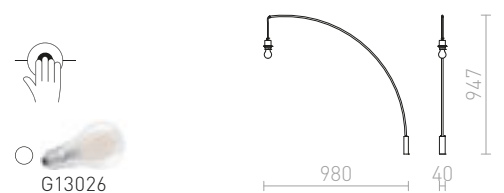



NIZZA

Base de mesa con brazo regulable de madera y base de metal laqueada. Cable de alimentación textil en color negro. Para pantallas con soporte E14 o E27.

NIZZA SOPORTE DE MESA

230 V E14 28 W

R12947 blanco/madera

€ 138

%



G12243

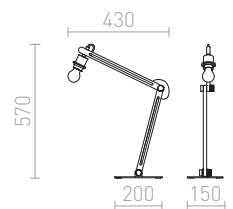

NIZZA

Pantalla textil para casquillo E27, adecuada para instalar en conjuntos colgantes y lámparas de mesa R12947.

NIZZA 18/15 PANTALLA

max 28 W

R13113 polialgodón blanco/PVC blanco

€ 58

R13114 polialgodón negro/PVC blanco

€ 58

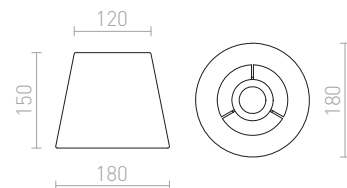

WOODY

Base de mesa hecha de prismas de madera, adecuada para pantallas con casquillo E27. El interruptor de acoplamiento se encuentra en la toma E27 para una fácil operación. Adecuado para pantallas: DELISA 25/16, CONNY 15/30, CONNY 35/30, RON 40/25, TEMPO 30/19.

WOODY SOPORTE DE MESA

230 V E27 25 W

R11791 roble

€ 98

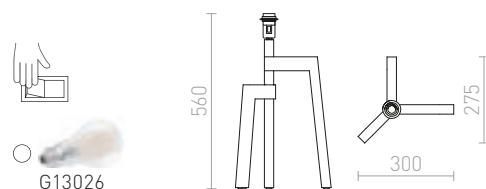

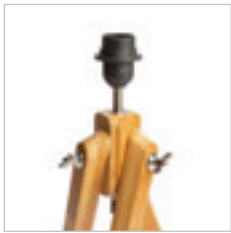

AMBITUS

Base de lámpara de mesa de bambú con casquillo E27. Pantallas adecuadas: ALVIS 24/15, DELISA 25/16, CONNY 15/30, CONNY 35/30, RON 40/25, TEMPO 30/19.

AMBITUS BASE LÁMPARA DE MESA

230 V E27 28 W

R13303 bambú

€ 120



G13026

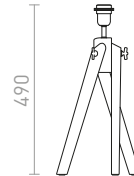

AMBITUS

Base de lámpara de pie realizada en bambú con casquillo E27. Pantallas adecuadas: AMBITUS 46/24, DELISA 35/30, CONNY 25/30, CONNY 35/30, RON 40/25, TEMPO 30/19.

AMBITUS BASE LÁMPARA DE PIE

230 V E27 28 W

R13304 bambú

€ 258



G13461

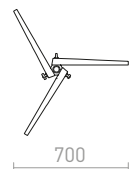
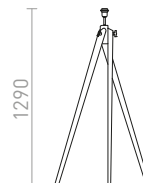



ALVIS

Pedestal de bambú para lámparas de pie con altura regulable para pantallas con casquillo E27. Adecuado para pantallas: AMBITUS 46/24, DELISA 35/30, CONNY 25/30, CONNY 35/30, RON 40/25, TEMPO 30/19.

ALVIS BASE LÁMPARA DE PIE

230 V E27 28 W

R13340 bambú/cromo

€ 215



G13461

775 - 1210

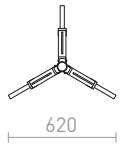

620

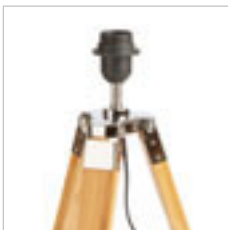

ALVIS

Soporte para lámpara de mesa de bambú para pantallas con casquillo E27. Adecuado para pantallas: ALVIS 24/15, DELISA 25/16, CONNY 15/30, CONNY 35/30, RON 40/25, TEMPO 30/19.

ALVIS BASE LÁMPARA DE MESA

230 V E27 28 W

R13339 bambú/cromo

€ 98



G13014

510

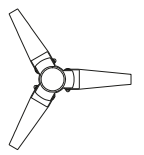
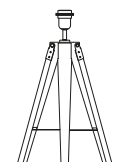

300



KEITH

Base de mesa en imitación haya con puerto USB incorporado. Combinar con pantallas con montaje de rosca E27. Apto para pantallas: CONNY 15/30, DELI 30/20, DELISA 25/16, RON 15/20

KEITH BASE DE MESA CON USB

230 V E27 40 W

R13639 blanco/haya

€ 98



G13026

400

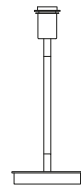

160



LUTON

Trípode de pie elegante en negro con accesorios de latón. Combinar con pantallas con montaje de rosca E27. Adecuado para pantallas: AMBITUS 46/24, DELISA 35/30, CONNY 25/30, CONNY 35/30, RON 40/25, TEMPO 30/19.

LUTON BASE DE SOPORTE

230 V E27 40 W

R13640 negro/latón

€ 150



G13026

1000 - 1560



935

600



MAUI

Base para lámpara de madera con casquillo E27.
Pantallas adecuadas: CONNY 15/30, DELI 30/20,
DELISA 25/16, RON 15/20.

MAUI BASE PARA MESA

230 V E27 20 W

R13437 madera

€ 48 %



G13014

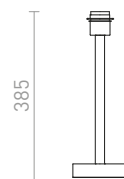

NYC

Base trípode de metal para pantallas con casquillo E27. Adecuado para pantallas: CONNY 25/30, CONNY 35/30, JAKARANDA, RON 40/25, TEMPO 30/19.

NYC TRIPOD SOPORTE DE PIE

230 V E27 42 W

R11992 cromo

€ 120



G13026

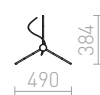

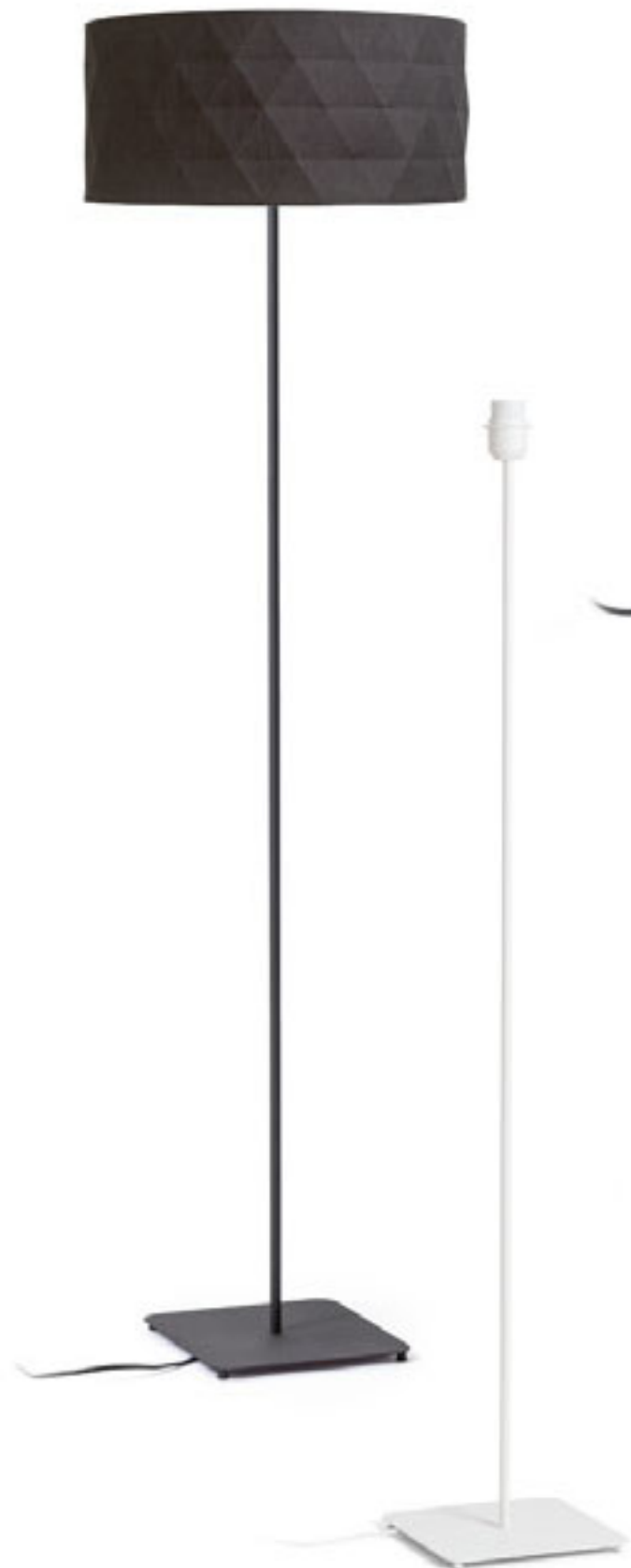

CORTINA

Base metálica de mesa para pantallas con fijación a casquillo E27. Adecuada para pantallas: CONNY 15/15, CONNY 15/30, RON 15/20, TEMPO 15/15, TEMPO 15/30.

CORTINA SOPORTE DE MESA

230 V E27 28 W

R12927 gris

€ 25 %

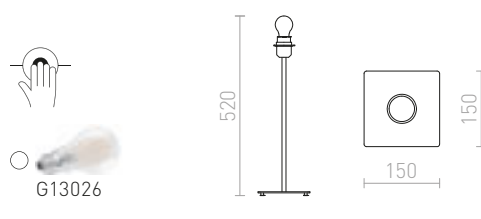

CORTINA

Base metálica de pie para casquillo E27. Adecuada para pantallas: CONNY 25/30, CONNY 35/30, RON 40/25, TEMPO 30/19.

CORTINA SOPORTE DE PIE

230 V E27 28 W

R12930 negro

€ 78

R13809 blanco

€ 78





NYC

Base de mesa en metal brillante y mate para pantallas con casquillo E27. Pantallas adecuadas: CONNY 15/15, CONNY 15/30, RON 15/20, TEMPO 15/15, TEMPO 15/30.

NYC SOPORTE DE MESA

230 V E27 42 W

R11990 cromo

€ 48

R12041 níquel mate

€ 48



G13026

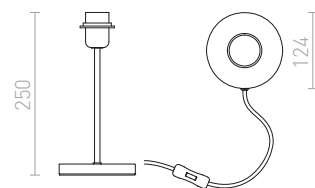

NYC

Base de pie en diseño de metal brillante para pantallas con casquillo E27. Adecuado para pantallas: CONNY 25/30, CONNY 35/30, JAKARANDA, RON 40/25, TEMPO 30/19.

NYC SOPORTE DE PIE

230 V E27 42 W

R11991 cromo

€ 120



G13026

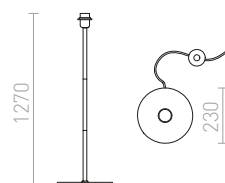



FIT

Cable de tres hilos con trenza textil en varios colores, longitud 4 m.

FIT 3x0,75 4M CABLE TEXTIL

230 V

R10251 negro

€ 24

R10252 blanco

€ 14 %

R10253 rojo

€ 14 %

R10254 gris

€ 14 %

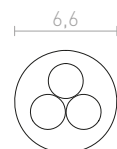

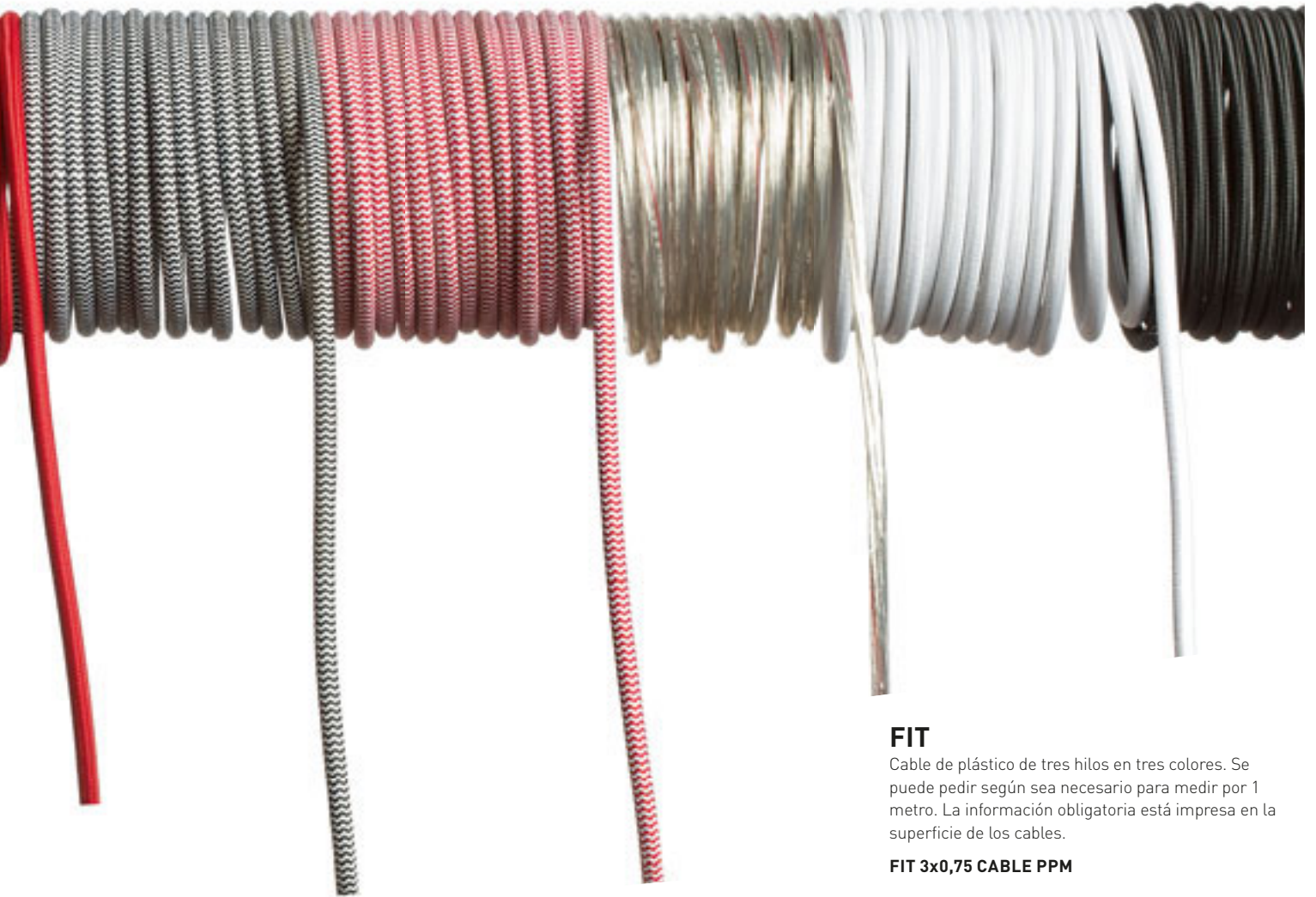

FIT

Cable de plástico de tres hilos en tres colores. Se puede pedir según sea necesario para medir por 1 metro. La información obligatoria está impresa en la superficie de los cables.

FIT 3x0,75 CABLE PPM

R12228 transparente	€ 3.50
R12229 gris	€ 3.20
R12230 negro	€ 3.20

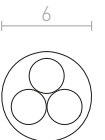

FIT

Cable de tres hilos con trenza textil en varios colores. Se puede pedir según sea necesario para medir por 1 metro.

FIT 3x0,75 CABLE TEXTIL PPM

R12214 blanco	€ 5
R12216 negro/blanco	€ 5
R12222 negro	€ 5
R12223 gris	€ 5
R12224 rojo	€ 5
R12225 lima	€ 5
R12226 fuchsia	€ 5
R12227 rojo/blanco	€ 5

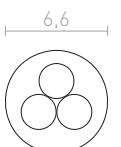
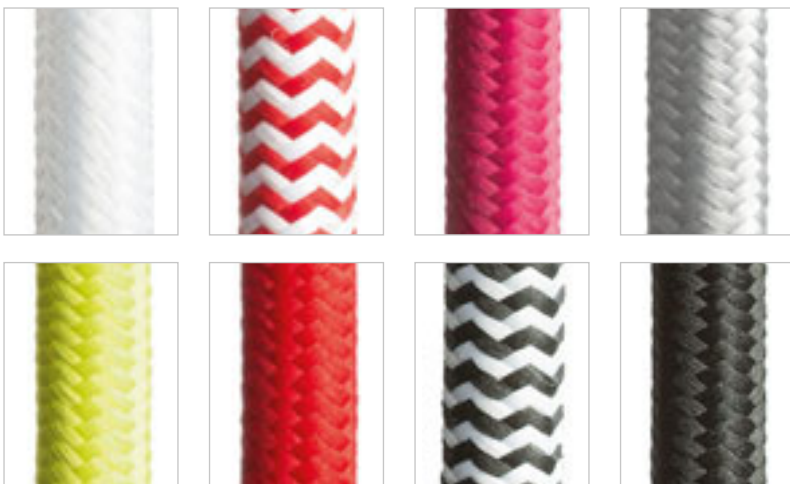



LUMINARIAS DE EXTERIOR

DECORATIVAS	630-631
CONJUNTOS	632-647
DE TECHO	648-655
INDIRECTA	656-657
ANGULAR DE PARED	658-671
ARRIBA - ABAJO	672-693
PARED DIRECCIONAL	694-697
CON ESTACA	698-703
POSICIÓN	704-711
EMPOTRADO EN LA PARED	712-723
EMPOTRADO EN EL SUELO	724-725

EXTERIOR DECORATIVAS



BABYMOON 56
630-631



BEACON
630-631

630-631

EXTERIOR CONJUNTOS



ELIA
632-633



ELIA PIR
632-633



ELIA
632-633

632-647



BOSANOVA 120
632-633



BOSANNA 150
632-633



BONNIE
634-635



BONNIE 80
634-635



CLYDE
634-635



CLYDE 60
634-635



VADIS
636-637



VADIS 90
636-637



GARRET
636-637



ABAX 65
638-639



SONET
638-639



SONET 450
638-639



PONDER 20
640-641



PONDER 65
640-641



TREEZA LED 25
640-641



TREEZA 65
640-641



RINA
642-643



RINA
642-643



RINA PIR
642-643



GARDIEN 65
642-643



BOBO RC
642-643



LIZZI
644-645



LIZZI I
644-645



LIZZI II
644-645



SORANO
644-645



SORANO II
644-645



MIZZI NEW I
646-647



MIZZI NEW II
646-647



MIZZI II
646-647

EXTERIOR DE TECHO



SENZA R
648-649



ORIN R
648-649



SAMMY
648-649

648-655



MERIDO
648-649



QUADRA M
650-651



RODGE
650-651



KEIG
650-651



SENZA SQ
650-651



ORIN SQ
650-651



SONYA 30
652-653



SONYA RC
652-653



SONNY
652-653



SCOTT
654-655



SPECTACLE
654-655



TARIS SQ 17
654-655



BONO
654-655

EXTERIOR INDIRECTA

656-657



ATLANTA 13
656-657



ATHI
656-657



TWIST
656-657

EXTERIOR ANGULAR DE PARED

658-671



CLAIRE RC
658-659

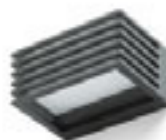

CLAIRE 14
658-659



CLAIRE 21
658-659



TIRAS II
658-659



WOOP
660-661



TORINO
660-661



CAMARGUE
660-661



SAMPO
660-661



DURANT
662-663



GINO
662-663



DURANT UP - DOWN
662-663



DELTA 145
664-665



DELTA 145
664-665



DELTA 215
664-665



DELTA 215
664-665



DELTA RC
666-667



CHICAGO
666-667



VERIA
666-667



ATHI
666-667



HIDE SQ
668-669



HIDE RC
668-669



ANDANTE
668-669



VECINO
670-671



CHLOE
670-671



TAPA
670-671



GAVIN
670-671

EXTERIOR ARRIBA - ABAJO



VIRGO
672-673

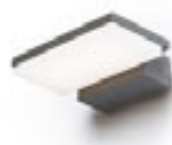

XYLO
672-673



COMODO
672-673

672-693



TWIST
672-673



CABOX II
674-675



TELO
674-675



MIZZI SQ I
674-675



DESMOND II
674-675



CARRE
676-677



TITO R
676-677



TITO SQ
676-677



KANE I
678-679



KANE II
678-679



GRANITA II
678-679



ZAZA
680-681



PIA
680-681



GIGI
680-681

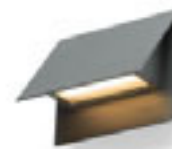

GERI
680-681



BOURDON
682-683



PIPER
682-683



SIV
682-683



SELMA
682-683



ZACK I
684-685



ZACK II
684-685



BEJA II
684-685



MIDZACK
684-685



KORSO I
686-687



KORSO II
686-687



KUBI I
686-687



KUBI II
686-687



DIXIE 4x12
688-689



DIXIE 10x16
688-689



PEKKO
688-689



UKKO
688-689



NICK II
688-689



MOIRE I
690-691



MOIRE II
690-691



MICO I
690-691



ZANE
690-691



CHOIX 114
692-693



CHOIX 175
692-693



LESA
692-693



MORA
692-693

EXTERIOR PARED DIRECCIONAL

694-697



DIREZZA
694-695



ORIT
694-695



FOX
694-695



BORA
696-697



PONTA
696-697

EXTERIOR CON ESTACA

698-703



CORDOBA
698-699



DIREZZA
698-699



GUN
698-699



BLUESTAR
698-699



COSMO
700-701



GARY LED
700-701



BORA
700-701



LORCA
700-701



HEAVY DUTY
702-703



ROSS
702-703



FOX
702-703



702-703

EXTERIOR POSICIÓN

704-711



FAROS
704-705



TOPTOP S
704-705



TOPTOP IV
704-705



BOBOR
706-707



BOBO RC
706-707



BOBO SQ
706-707



RENO SQ INDR
708-709



RENO SQ DR
708-709



RENOR
708-709



AQILA R
710-711



AQILA SQ
710-711



AQILA RC
710-711



ITAKA
710-711

EXTERIOR EMPOTRADO EN LA PARED



KICK I
712-713



KICK II
712-713



KICK III
712-713

712-723



ASTERIA
714-715



MARCO
714-715



ELICA R
714-715



CLUB
714-715



CLUB IND
714-715



ELICA SQ
716-717



TESS SQ
716-717



PER
716-717



RASQ
716-717



GORDIQ S
718-719



GORDIQ L
718-719



GORDIQ M
718-719



RAGG
718-719



DEJAVU SQ 9
720-721



DEJAVU SQ 14
720-721



FACA
722-723



GAP
722-723



AKORD
722-723



SEGNO
722-723

EXTERIOR EMPOTRADO EN EL SUELO



NAVY
724-725



TERRA
724-725



ORBU R
724-725



RIZZ SQ 105
724-725



ORBU SQ 10
724-725





IP44

IP44

BABYMOON

Bolas de ópalo de termoplástico para bombillas ahorrativas. Adecuada para su uso en el jardín. La luminaria se puede usar como colgante o como una lámpara de suelo. Incluyendo un cable de alimentación de 170 cm.

BABYMOON 56 COLGANDO EN PIE

230 V E27 23 W IP44

R10372 PE satinado

€ 398

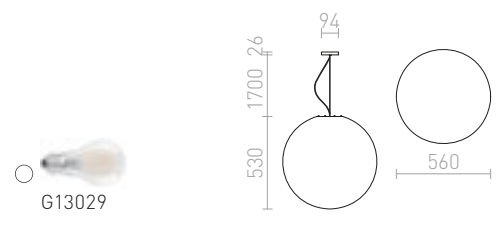

IP44

BEACON

Aplique de exterior retro con pantalla de cristal transparente para bombilla con casquillo E27.

BEACON MURO

230 V E27 60 W IP44

R13614 negro/vidrio texturado

€ 120

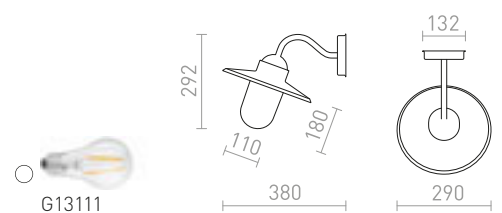



IP65

IP65

BOSANOVA

Luminaria de pie con pantalla de plástico. El cable de suministro termina con un enchufe de seguridad.

BOSANOVA 120 EN PIE

230 V E27 25 W IP65

R12420 gris antracita/PE satinado

€ 380 →

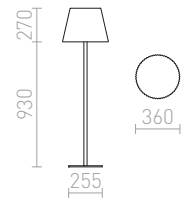

BOSANNA

Luminaria de pie con pantalla de plástico. El cable de suministro termina con un enchufe de seguridad.

BOSANNA 150 EN PIE

230 V E27 25 W IP65

R12421 gris antracita/PE satinado

€ 380 →

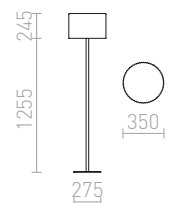



IP44

ELIA

Lámpara para pared de exterior de aluminio macizo con LED incorporado y difusor de color ópalo, de la serie ELIA.

ELIA DE PARED

230 V LED 9 W 3000 K 720 lm Ra 80 IP44

R13930 gris antracita

€ 88

NEW

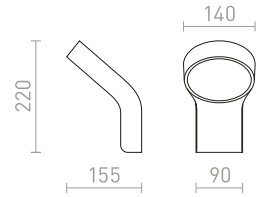

IP44

ELIA

Lámpara para pared de exterior de aluminio macizo con LED incorporado y difusor de color ópalo, de la serie ELIA. Incluye un sensor de movimiento configurable.

ELIA PIR DE PARED

230 V LED 9 W 3000 K 720 lm Ra 80 IP44

R13931 gris antracita

€ 120

NEW

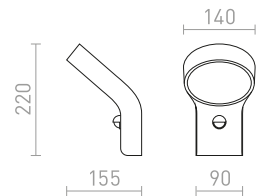

IP44

ELIA

Bolardo de exterior de aluminio macizo con LED incorporado y difusor de color ópalo, de la serie ELIA.

ELIA EN PIE

230 V LED 9 W 3000 K 720 lm Ra 80 IP44

R13932 gris antracita

€ 158

NEW

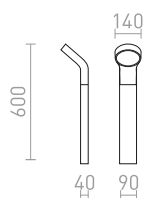



IP44

BONNIE

Aplique de exterior con tapa opalina para bombilla LED con casquillo E27.

BONNIE MURO

230 V E27 28 W IP44

R13635 gris antracita

€ 48



G13307

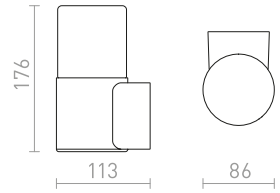

IP44

BONNIE

Lámpara de pie de exterior con tapa opalina para bombilla LED con casquillo E27.

BONNIE 80 POSTE

230 V E27 28 W IP44

R13636 gris antracita

€ 129



G13307

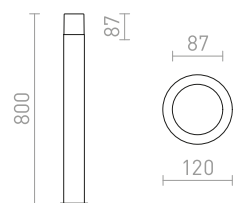



IP44

CLYDE

Aplique de exterior con tapa opalina para bombilla LED con casquillo E27.

CLYDE MURO

230 V E27 28 W IP44

R13637 gris antracita

€ 58

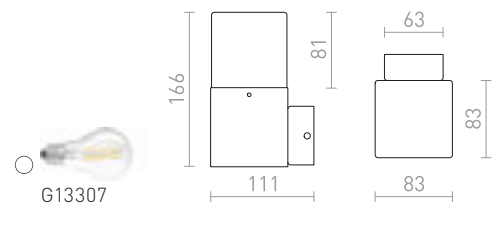

IP44



CLYDE

Lámpara de pie de exterior con tapa opalina para bombilla LED con casquillo E27.

CLYDE 60 POSTE

230 V E27 28 W IP44

R13638 gris antracita

€ 120

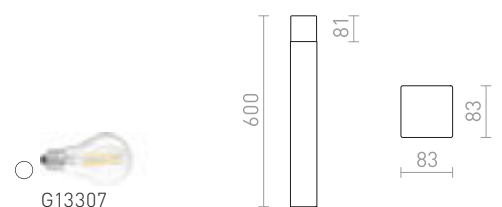



IP65

GARRET

Lámpara de pared LED cilíndrica para exteriores para iluminación ambiental.

GARRET DE PARED

230 V LED 15 W 3000 K 750 lm Ra 80 IP65

R12548 gris antracita

€ 88

%

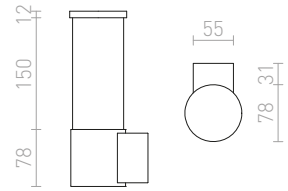

IP54

VADIS

Luminaria para exteriores. La pantalla está hecha de policarbonato escarchado.

VADIS DE PARED

230 V LED 8 W 3000 K 520 lm Ra 80 IP54

R10547 gris antracita

€ 150

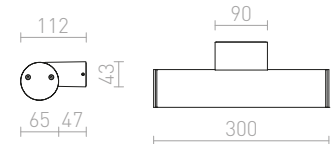

IP54

VADIS

Luminaria para exteriores. La pantalla está hecha de policarbonato escarchado.

VADIS 90 EN PIE

230 V LED 8 W 3000 K 520 lm Ra 80 IP54

R10548 gris antracita

€ 220

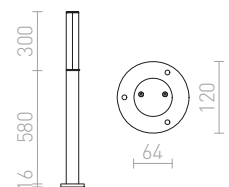





IP54



SONET

Luminaria para exteriores diseñada solo para ser instalada en la pared. Clase de protección IP54 con luz hacia abajo.

SONET DE PARED

230 V LED 7 W 3000 K 490 lm Ra 80 IP54

R11170 gris antracita

€ 129

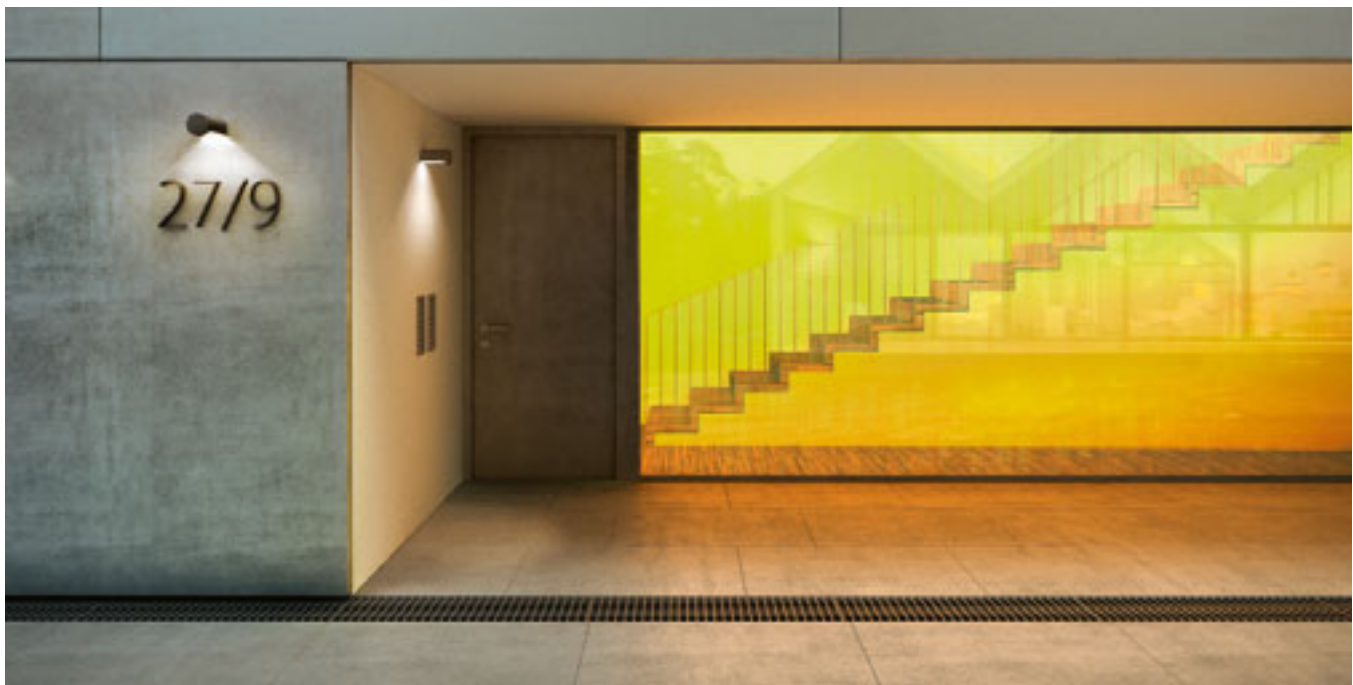
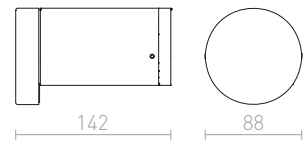
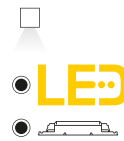

IP54



ABAX

Lámpara de pie LED. Adecada para exteriores y con la iluminación a todos los lados.

ABAX 65 EN PIE

230 V LED 15 W 3000 K 423 lm Ra 80 IP54

R12626 gris antracita

€ 290

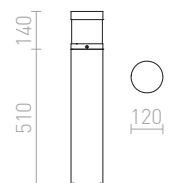



IP54

SONET

Lámpara de pie LED para exterior. Adecuada para iluminar carreteras y pavimentos.

SONET 450 EN PIE

230 V LED 7 W $\angle 55^\circ$ 3000 K 477 lm Ra 80 IP54

R11171 gris antracita

€ 198

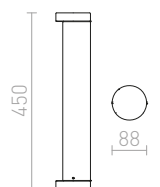
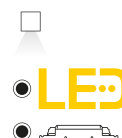



IP54

IP54

TREEZA

Lámpara de pie para exteriores. El interior está pintado con un color dorado, que crea una luz suave y cálida.

TREEZA LED 25 EN PIE

230 V LED 7 W $\angle 60^\circ$ 3000 K 123 lm Ra 80 IP54

R10380 gris antracita

€ 178

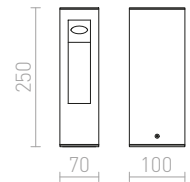

TREEZA

Lámpara de pie para exteriores, apta para las fuentes de luz energéticamente eficientes con el casquillo E27. La cubierta frontal es de vidrio satinado.

TREEZA 65 EN PIE

230 V E27 26 W IP54

R10441 gris antracita

€ 150

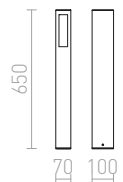



IP44

IP44

PONDER

Luminaria para exteriores de aluminio fundido a presión con vidrio satinado. Puede ser instalada en la pared o al suelo.

PONDER 20 DE PARED O DE PIE

230 V E27 18 W IP44

R10367 negro

€ 98

R10368 gris plata

€ 78 →

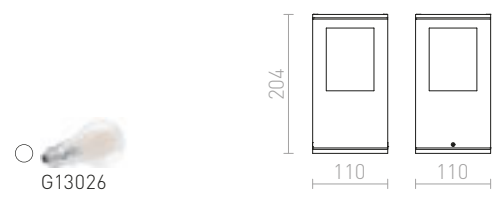

PONDER

Luminaria para exteriores de pie para las fuentes de luz de bajo consumo con casquillo E27. Las cortinas están hechas de vidrio satinado.

PONDER 65 EN PIE

230 V E27 18 W IP44

R10433 negro

€ 158

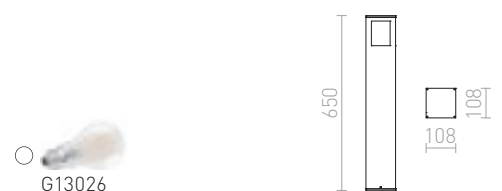



IP65



BOBO

Bolardo de exterior de aluminio con LED incorporado, para iluminación diagonal y hacia abajo de caminos y entradas de vehículos.

BOBO RC EN PIE

230 V LED 8W 3000 K 640 lm Ra 80 IP65

R13936 gris antracita

€ 150 **NEW**

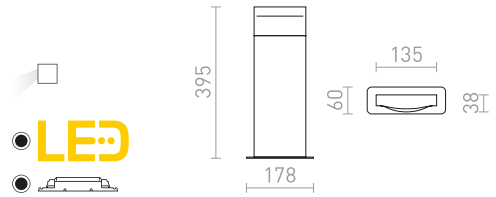

IP44

RINA

Lámpara de pie LED para exteriores con iluminación hacia abajo. Hecha de aluminio fundido a presión y tapa inferior en color ópalo.

RINA EN PIE

230 V LED 12W 3000 K 1000 lm Ra 80 IP44

R12515 gris antracita

€ 198

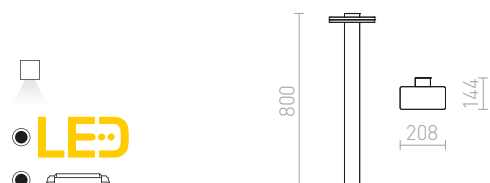



IP65

RINA

Aplique para exterior de aluminio fundido a presión, con LED integrado y tapa inferior en color ópalo. Sólo para instalación hacia abajo.

RINA DE PARED

230 V LED 12 W 3000 K 1000 lm Ra 80 IP65

gris antracita

€ 150

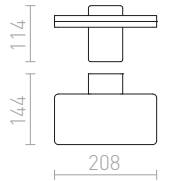
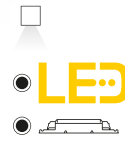

IP65

RINA

Aplique de exterior LED con sensor integrado y posibilidad de configurar funciones. Tipo de iluminación hacia abajo. Fabricado en aluminio fundido a presión, tapa inferior opalina.

RINA PIR MURO

230 V LED 12 W 3000 K 900 lm Ra 80 IP65

R13654 gris antracita

€ 178

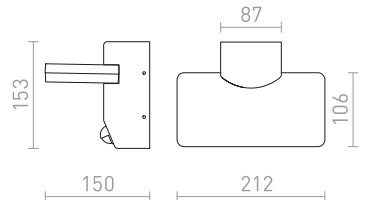
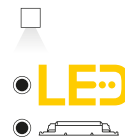

IP54

GARDIEN

Lámpara de pie LED de exterior fabricada en aluminio fundido a presión, tipo de iluminación hacia abajo. Los LED están cubiertos con un difusor esmerilado.

GARDIEN 65 PIE

230 V LED 10 W 3000 K 600 lm Ra 80 IP54

R13758 negro

€ 178

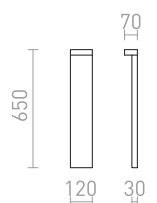
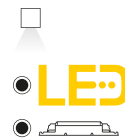



IP54

LIZZI

Plafón de exterior con portalámparas GU10.

LIZZI DE TECHO

230 V GU10 35 W IP54

R13505 blanco

€ 58

R13507 gris antracita

€ 58

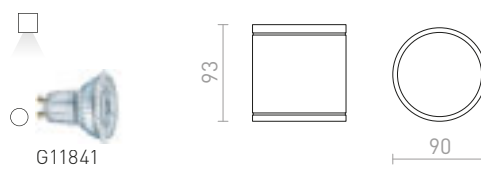

IP54

IP54

LIZZI

Aplique de aluminio para exteriores para fuentes de luz con casquillo GU10. Las dimensiones de la base son AL / An / Pr 10 / 6 / 3.1 cm.

LIZZI I DE PARED

230 V GU10 35 W IP54

R13508 gris antracita

€ 68

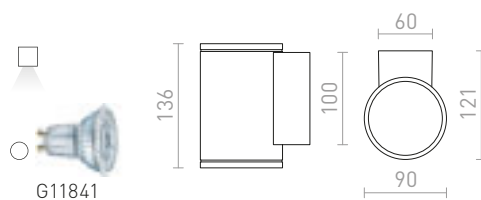

LIZZI II DE PARED

230 V GU10 2x35 W IP54

R13509 gris antracita

€ 78

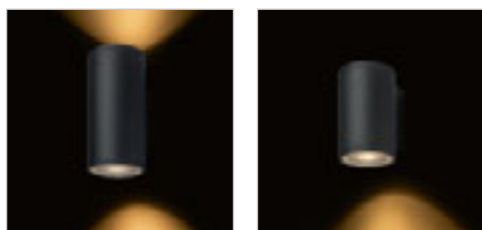
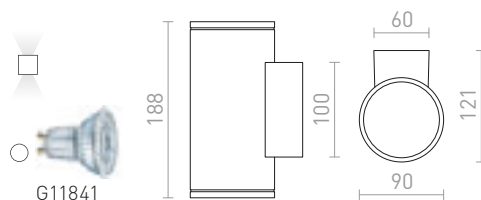



IP44



IP44



SORANO

Cilindro de techo para exterior fabricado en fibra de carbono, para bombilla LED con casquillo GU10. El cuerpo de carbono de la luminaria tiene una alta resistencia al agua salada.

SORANO TECHO

230 V LED GU10 8 W IP44

R13633 negro/plástico

€ 24

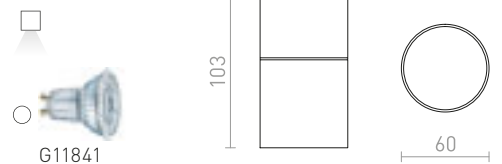

SORANO II MURO

230 V LED GU10 2x8 W IP44

R13634 negro/plástico

€ 35

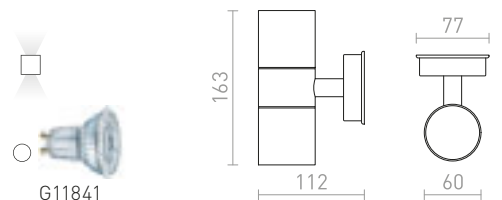



IP65

MIZZI NEW

Aplique de exterior fabricado en aluminio fundido a presión para fuentes de luz con casquillo GU10.

MIZZI NEW I DE PARED

230 V GU10 35 W IP65

R13755 gris antracita

€ 48

R13796 gris plata

€ 48

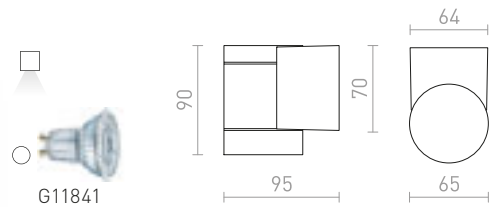

MIZZI NEW II MURO

230 V GU10 2x35 W IP65

R13643 gris antracita

€ 58

R13797 gris plata

€ 58

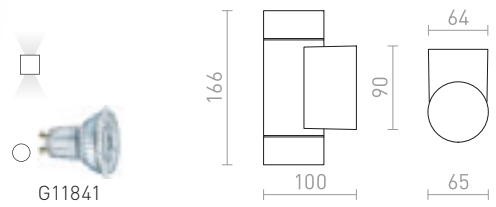

IP54



MIZZI

Luminaria de pared para exteriores, fabricada de aluminio fundido a presión. Para fuentes de luz GU10.

MIZZI II

230 V GU10 2x35 W IP54

R10553 gris plata

€ 48

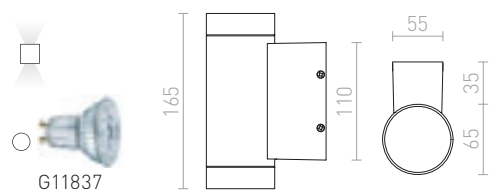





IP54



MERIDO

Plafón para exteriores y fuentes de luz GX53 de bajo consumo.

MERIDO DE TECHO
230 V GX53 11 W IP54

R10428 blanco € 58

R10429 gris plata € 58

R10430 gris antracita € 58

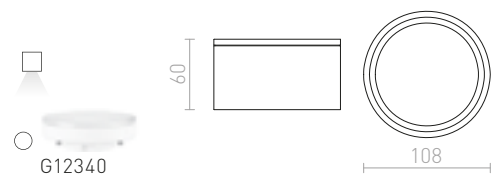



IP54

ORIN

Luminaria de techo LED cilíndrica con pantalla satinada. Apta para exteriores.

ORIN R TECHO

230 V LED 10 W 3000 K 650 lm Ra 80 IP54

R13626 blanco/acrílico satinado

€ 78

R13627 gris antracita/acrílico satinado

€ 78

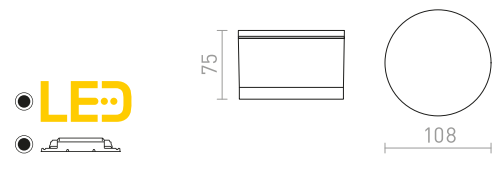

IP65

SENZA

Luminaria LED cilíndrica con cubierta de vidrio transparente con el perímetro en color negro.

SENZA R TECHO

230 V LED 6 W 3000 K 480 lm Ra 80 IP65

R13622 blanco/vidrio transparente

€ 98

R13623 gris antracita/vidrio transparente

€ 98

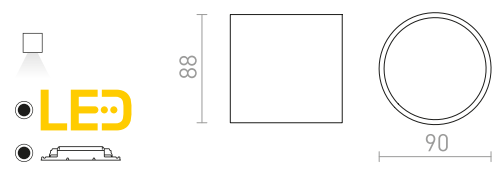

IP54

SAMMY

Plafón para exteriores con casquillo GU10. Tiene una cubierta de vidrio transparente en la parte inferior.

SAMMY EXTERIOR

230 V LED GU10 15 W IP54

R13450 blanco

€ 58

R13451 gris

€ 48

R13452 gris antracita

€ 58

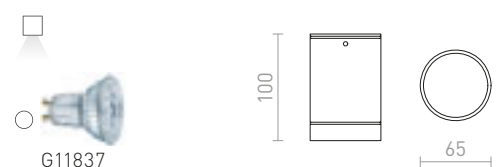



IP65

KEIG

Luminaria de exterior cuadrada para bombilla LED con casquillo GU10.

KEIG TECHO

230 V GU10 35 W IP65

R13631 blanco

€ 48

R13632 negro

€ 48



G11841

103

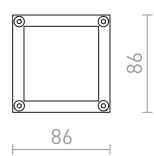

IP54

RODGE

Plafón de exterior con casquillo GU10.

RODGE DE TECHO

230 V GU10 35 W IP54

R13503 blanco

€ 48

R13510 gris

€ 48

R13511 gris antracita

€ 58



G11841

94

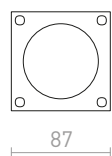

IP54

QUADRA M

Luminaria de techo para exteriores. Para las fuentes de luz halógenas PAR20.

QUADRA M DE TECHO

230 V E27 75 W IP54

R10385 gris antracita

€ 58

R10386 gris plata

€ 48



G13020

140

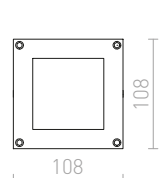
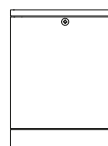

%



IP54

**ORIN**

Luminaria de techo LED cuadrada para exterior con pantalla satinada.

ORIN SQ TECHO

230 V LED 10 W 3000 K 800 lm Ra 80 IP54

R13628 blanco/acrílico satinado

€ 78

R13629 gris antracita/acrílico satinado

€ 78

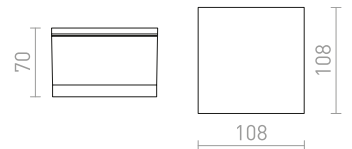

IP65

**SENZA**

Plafón para exterior LED. La luminaria tiene un cubreobjetos transparente, que se encuentra en el perímetro del color del cuerpo de la luminaria.

SENZA SQ TECHO

230 V LED 6 W 3000 K 580 lm Ra 80 IP65

R13624 blanco/vidrio transparente

€ 88

R13625 gris antracita/vidrio transparente

€ 88

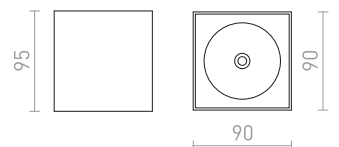
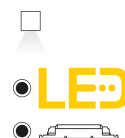





IP54



SONNY

Luminaria de techo para exteriores con dos roscas para las fuentes de luz energéticamente eficientes.

SONNY DE TECHO

230 V E27 2x18 W IP54

R10382 gris antracita

€ 88

R10383 gris plata

€ 88



G13026

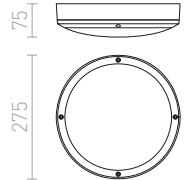

IP54



IP54



SONYA

Luminaria de aluminio para exterior. Equipada con difusor opal de policarbonato para el montaje en techo o pared.

SONYA RC

230 V E27 2x18 W IP54

R10363 gris plata

€ 58



G13026

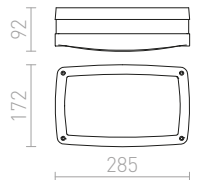

SONYA 30

230 V E27 2x18 W IP54

R10361 negro

€ 98

R10362 gris plata

€ 98



G13155

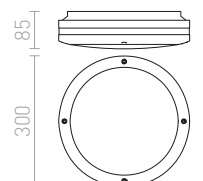



IP65

BONO

Luminaria para exteriores de aluminio fundido a presión, con LED integrado y difusor de color ópalo. Para montaje en techo o pared.

BONO MONTADAS EN SUPERFICIE

230 V LED 4 W 3000 K 297 lm Ra 80 IP65

R11967 gris antracita

€ 150

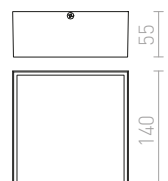
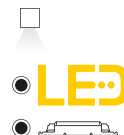



IP54

**SCOTT**

Luminaria LED de forma cuadrada. La cubierta está hecha de acrílico lacado.

SCOTT DE TECHO

230 V LED 9,8 W 3000 K 637 lm Ra 80 IP54

R10552 gris plata

€ 68

%

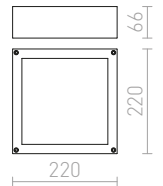
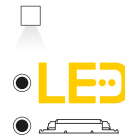

IP54

TARIS

Luminaria LED cuadrada de pared / techo con esquinas redondeadas.

TARIS SQ 17 MONTADAS EN SUPERFICIE

230 V LED 8 W 3000 K 550 lm Ra 80 IP54

R12525 negro/plástico

€ 24

%

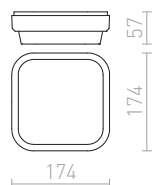

IP54

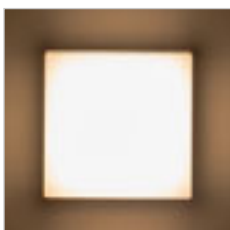
**SPECTACLE**

Luminaria para exteriores de aluminio fundido a presión, con LED integrado y difusor de color ópalo. Para montaje en techo o pared.

SPECTACLE MONTADAS EN SUPERFICIE

230 V LED 5 W 3000 K 350 lm Ra 80 IP54

R11968 gris plata

€ 78

%

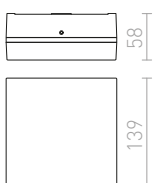

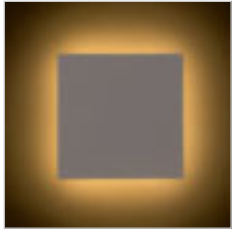

IP54

ATHI

Luminaria LED cuadrada de pared para iluminación indirecta mediante la reflexión de la luz sobre la pared. Adecuada para uso en interiores y exteriores.

ATHI DE PARED

230 V LED 9,6 W 3000 K 550 lm Ra 80 IP54

R12551 blanco

€ 120

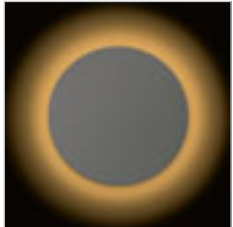
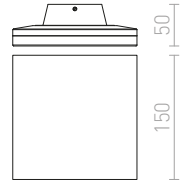

IP54

ATLANTA

Luminaria LED circular de pared para iluminación indirecta mediante la reflexión de la luz sobre la pared. Adecuada para uso en interiores y exteriores.

ATLANTA 13 MONTADAS EN SUPERFICIE

230 V LED 6 W 3000 K 780 lm Ra 80 IP54

R12825 blanco

€ 78

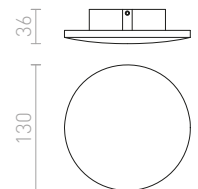



IP65

TWIST

Luminaria de pared LED de aluminio, para exterior con posibilidad de regular la iluminación hacia abajo o como iluminación indirecta hacia arriba.

TWIST MURO

230 V LED 12 W 3000 K 980 lm Ra 80 IP65

R13615 blanco

€ 98

R13616 gris antracita

€ 98

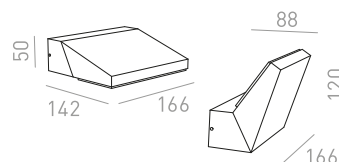



IP54

TIRAS

Luminaria LED de pared para exteriores, fabricado en aluminio laqueado fundido en presión y con difusores para iluminación ARRIBA/ABAJO.

TIRAS II DE PARED

230 V LED 2x6 W 3000 K 371 lm Ra 80 IP54

R13569 gris antracita/acrílico esmerilado

€ 78

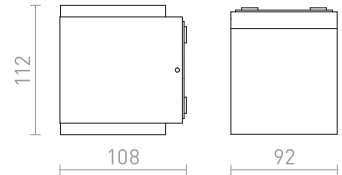

IP54

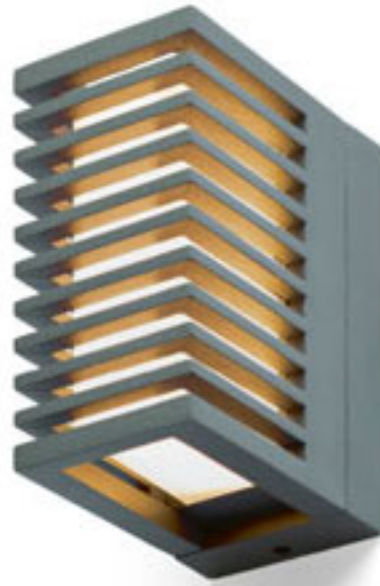

IP54

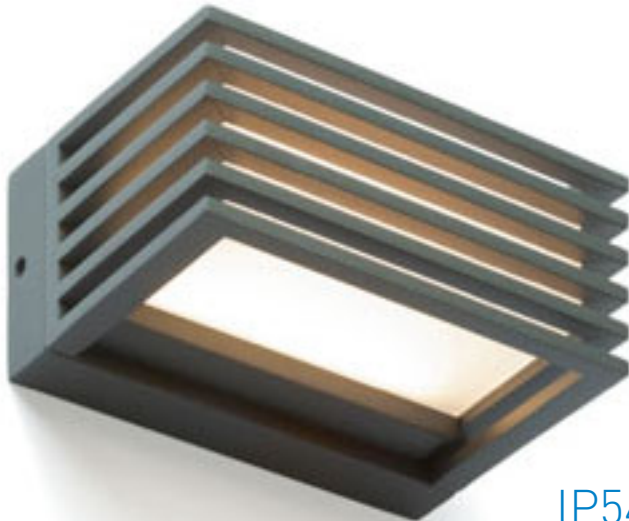

IP54

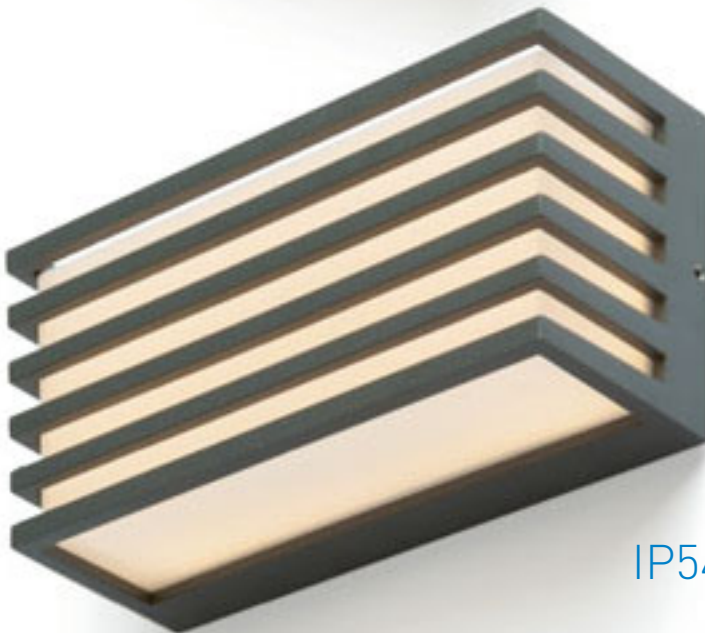

CLAIRE

Luminaria LED para exterior. El cuerpo de la luminaria está fabricado en aluminio laqueado fundido a presión.

CLAIRE RC DE PARED

230 V LED 6 W 3000 K 143 lm Ra 80 [IP54](#)

R13563 gris antracita/acrílico esmerilado **€ 120**

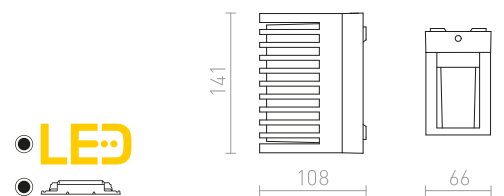

CLAIRE 14 DE PARED

230 V LED 6 W 3000 K 240 lm Ra 80 [IP54](#)

R13564 gris antracita/acrílico esmerilado **€ 120**

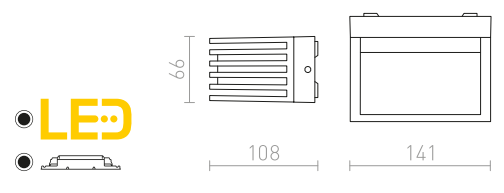

CLAIRE 21 DE PARED

230 V LED 9 W 3000 K 384 lm Ra 80 [IP54](#)

R13565 gris antracita/acrílico esmerilado **€ 129**

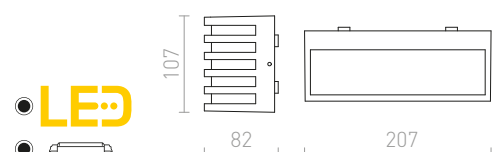

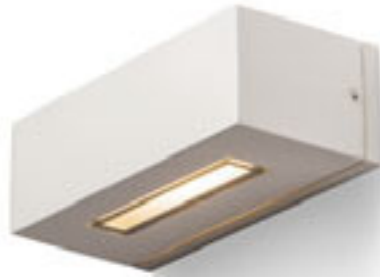

IP54



WOOD

Luminaria ARRIBA/BAJO para exteriores. Un lado de la lámpara tiene un cristal transparente claro con un marco negro. El otro lado de la luminaria tiene un vidrio esmerilado más estrecho con un marco negro.

WOOD DE PARED

230 V R7s 78mm 48 W IP54

R10437 blanco

€ 48

%

R10438 gris plata

€ 48

%

R10439 gris antracita

€ 58

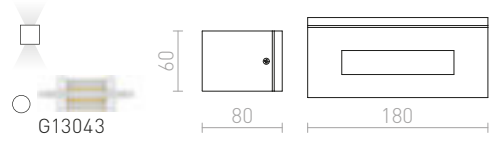

IP54

TORINO

Luminaria de pared LED rectangular, con iluminación ARRIBA/BAJO.

TORINO DE PARED

230 V LED 2x5 W 3000 K 550 lm Ra 80 IP54

R12573 blanco

€ 129

R12574 negro

€ 129

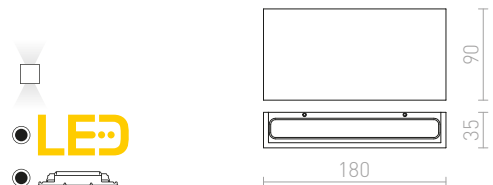



IP65

SAMPO

Aplique LED de aluminio para exterior de forma rectangular con iluminación asimétrica hacia abajo.

SAMPO MURO

230 V LED 9 W 3000 K 650 lm Ra 80 IP65

R13619 gris antracita

€ 98

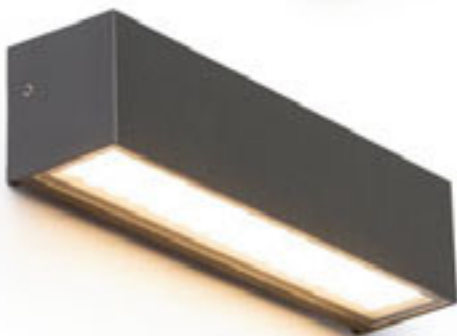
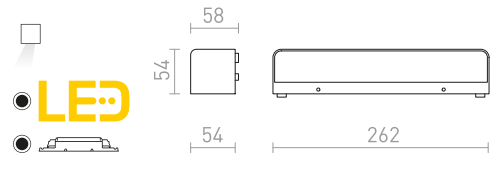

IP65

CAMARGUE

Aplique LED rectangular con iluminación hacia abajo.

CAMARGUE DE PARED

230 V LED 6 W 3000 K 550 lm Ra 80 IP65

R13527 gris plata/vidrio satinado

€ 129

R13641 gris antracita/vidrio satinado

€ 129

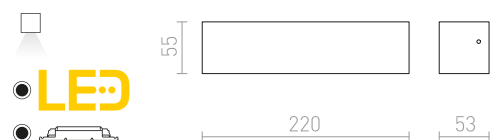

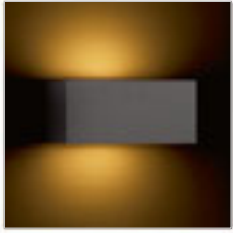

IP54



IP54

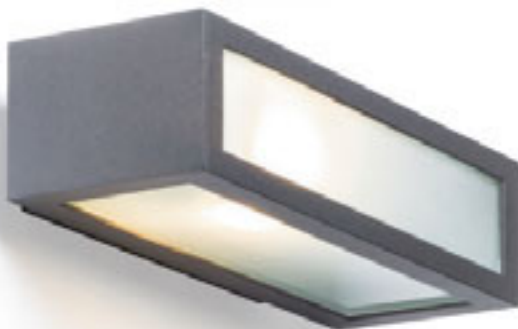

IP44

DURANT

Luminaria rectangular de pared para exteriores con iluminación ARRIBA/ABAJO para fuente de luz E27.

DURANT UP - DOWN DE PARED

230 V E27 18 W IP54

R12559 gris antracita

€ 120

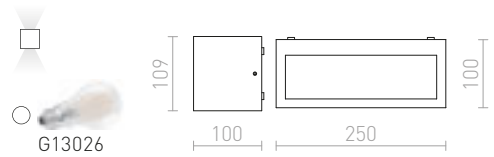

DURANT

Luminaria para exteriores, con casquillo E27 para fuente de luz de consumo energético ahorrativo.

DURANT DE PARED

230 V E27 18 W IP54

R12568 gris plata

€ 88

R12569 gris antracita

€ 98

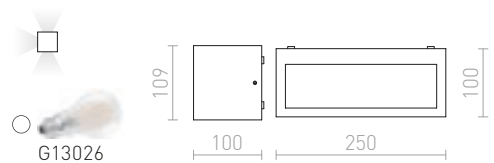

GINO

Luminaria de pared para exteriores, con cristales satinados. Dimensiones de base L / A / P 2/6/20 cm.

GINO DE PARED

230 V E27 18 W IP44

R10387 gris antracita

€ 98

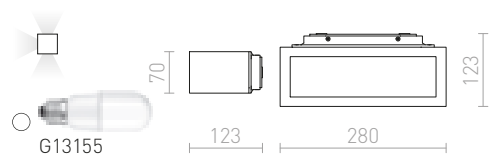







IP54



IP54



IP54



IP54

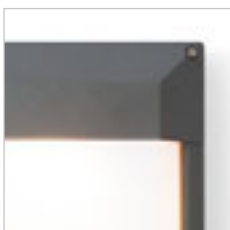

DELTA

Lámpara de pared al aire libre adecuada para terrazas y entradas de casas. Para fuentes de luz de ahorro energético GX53 o E27, dependiendo del modelo.

DELTA 145 MONTADAS EN SUPERFICIE

230 V GX53 9 W IP54

R12563 gris antracita

€ 48

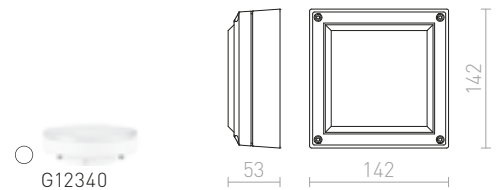

DELTA 215 MONTADAS EN SUPERFICIE

230 V E27 18 W IP54

R12564 gris antracita

€ 88

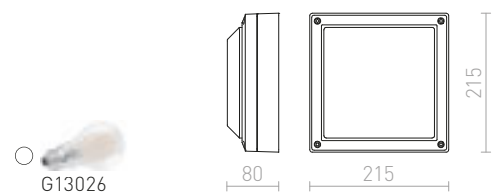

DELTA

Lámpara de pared al aire libre adecuada para terrazas y entradas de casas. Para fuentes de luz de ahorro energético GX53 o E27, dependiendo del modelo.

DELTA 145 DE PARED

230 V GX53 9 W IP54

R12565 gris antracita

€ 48

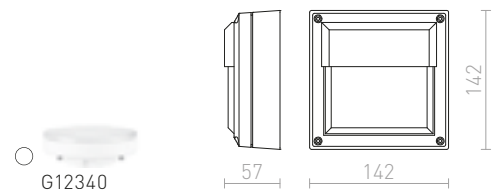

DELTA 215 DE PARED

230 V E27 18 W IP54

R12566 gris antracita

€ 88

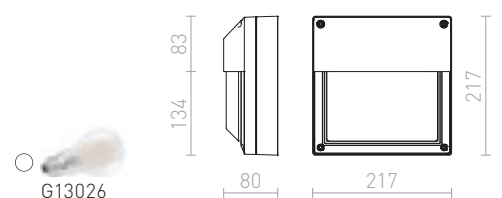

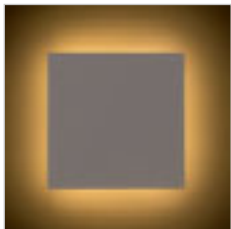

IP54

ATHI

Luminaria LED cuadrada de pared para iluminación indirecta mediante la reflexión de la luz sobre la pared. Adecuada para uso en interiores y exteriores.

ATHI DE PARED

230 V LED 9,6 W 3000 K 550 lm Ra 80 IP54

R12551 blanco

€ 120

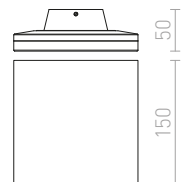



IP54

DELTA

Luminaria para exteriores, con casquillo E27 para ahorro energético.

DELTA RC DE PARED

230 V E27 18 W IP54

R12567 gris antracita

€ 78 %

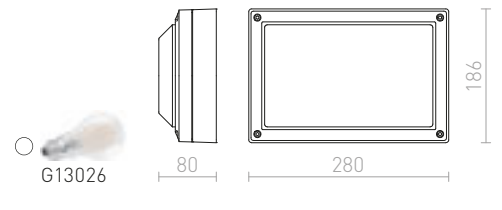

IP44

CHICAGO

Luminaria para exteriores. Fabricada de aluminio fundido a presión, con difusor opalino para el montaje en pared. Para una bombilla de bajo consumo o LED de E27.

CHICAGO DE PARED

230 V E27 18 W IP44

R12018 gris antracita

€ 68

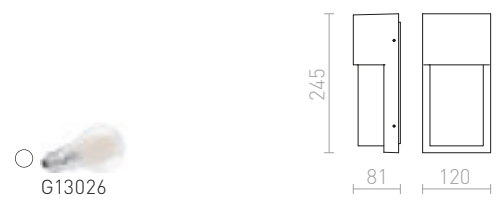

IP54

VERIA

Lámpara LED plana de pared para exteriores.

VERIA DE PARED

230 V LED 6 W $\angle 116^\circ$ 3000 K 629 lm Ra 80 IP54

R11169 gris plata

€ 120 %

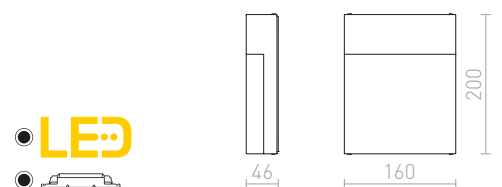





IP54

HIDE

Lámpara de pared para exteriores con la iluminación suave y adecuada para terrazas y entradas de casa. Para la fuente de luz E27.

HIDE RC DE PARED

230 V E27 18 W IP54

R12561 gris antracita

€ 98

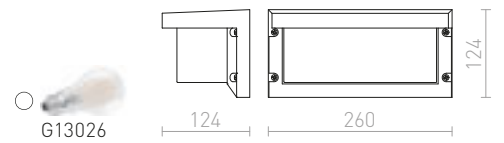

IP44

HIDE SQ DE PARED

230 V E27 13 W IP44

R12560 gris antracita

€ 88

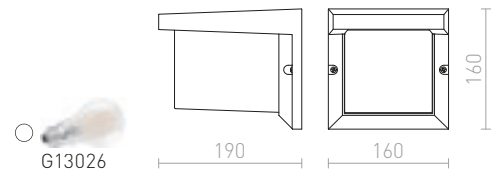

IP65

ANDANTE

Lámpara de techo con LED incorporado, adecuada para la iluminación de terrazas o entradas de viviendas.

ANDANTE DE PARED

230 V LED 21 W 3000 K 1200 lm Ra 80 IP65

R13504 gris antracita/acrílico mate

€ 138

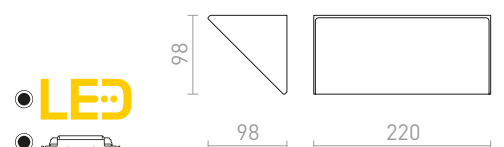



IP54

TAPA

Lámpara de pared LED rectangular para exteriores, con iluminación ARRIBA/BAJO y fabricada en metal laqueado.

TAPA DE PARED

230 V LED 6 W 3000 K 277 lm Ra 80 IP54

R13562 blanco

€ 68 →

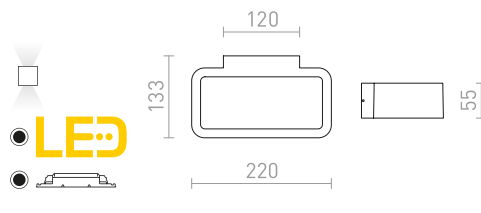

IP54

VECINO

Luminaria de pared para exteriores. Fabricada de aluminio fundido a presión con cubierta inferior en color ópalo.

VECINO DE PARED

230 V LED 5 W 3000 K 330 lm Ra 80 IP54

R10351 gris plata

€ 58 %

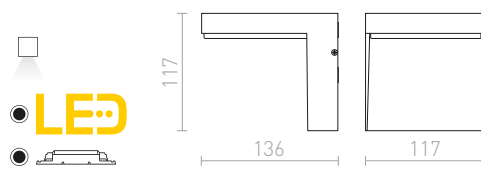

IP65

CHLOE

Lámpara de pared LED, rectangular, hecha de acero inoxidable. Proporciona iluminación indirecta. Es adecuada para exteriores e interiores.

CHLOE DE PARED

230 V LED 9 W 3000 K 800 lm Ra 80 IP65

R11752 acero inoxidable

€ 120 →

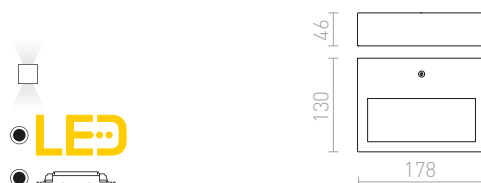

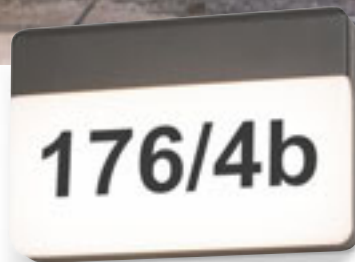
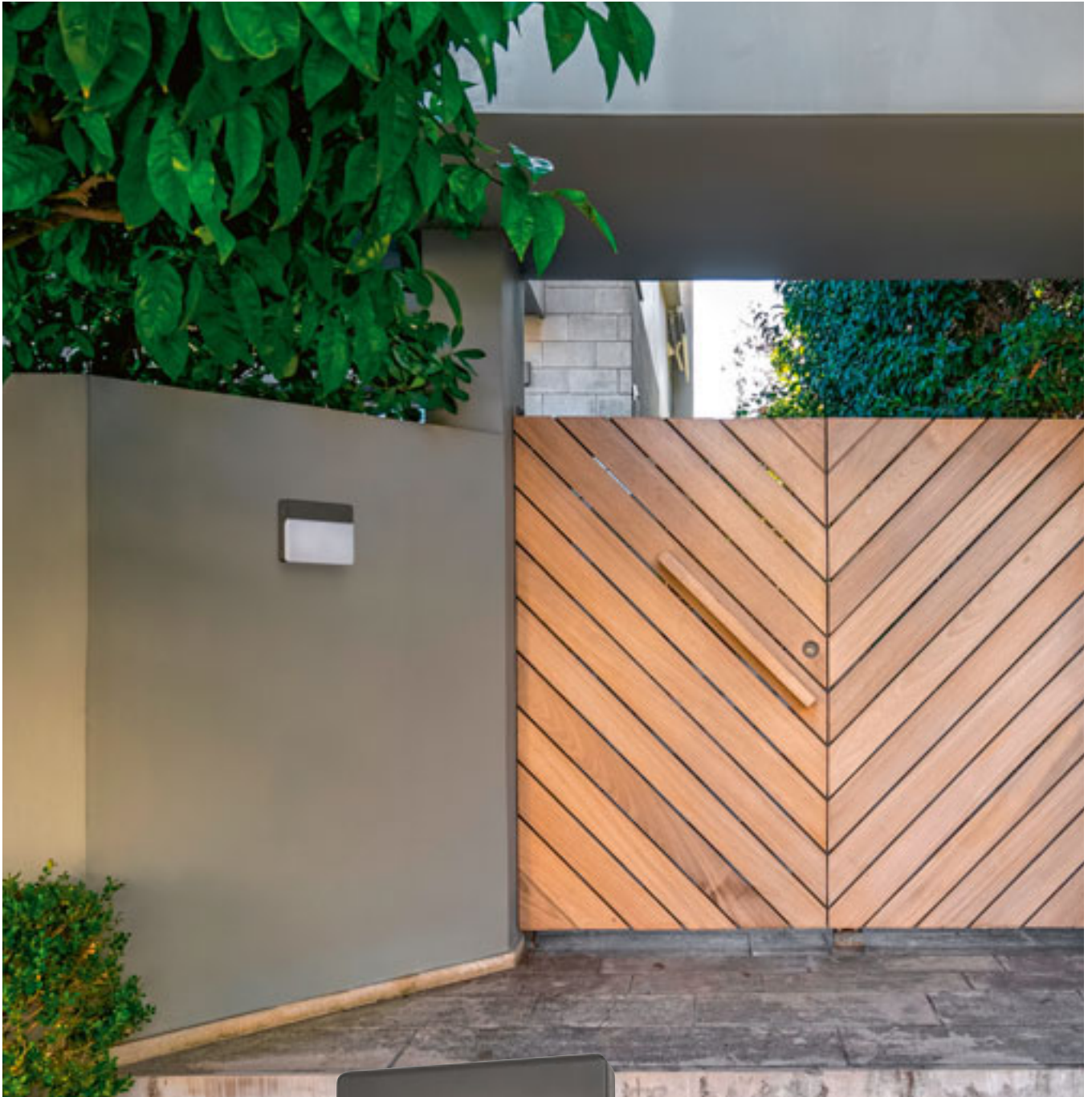

IP65

GAVIN

Aplique LED plano de exterior apto para iluminar puertas de entrada, pasillos o escaleras. La luminaria también es adecuada para colocar números u otros símbolos (no incluidos).

GAVIN DE PARED

230 V LED 13 W 3000 K 650 lm Ra 80 IP65

R13756 gris antracita/acrílico esmerilado

€ 120

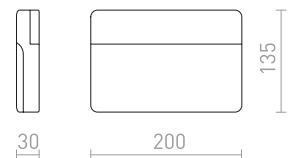



COMODO

Aplique de pared con LED incorporado para iluminación descendente.

COMODO DE PARED

230 V LED 20 W 3000 K 940 lm Ra 80 IP65

R13512 gris antracita

€ 150

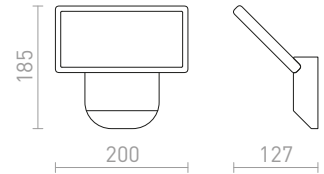
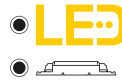

VIRGO

Lámpara de pared para exteriores LED con iluminación hacia abajo. Fabricada de aluminio fundido a presión. La cubierta inferior es de color ópalo.

VIRGO DE PARED

230 V LED 9 W 3000 K 800 lm Ra 80 IP65

R11946 gris antracita

€ 88

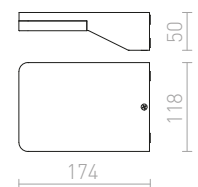
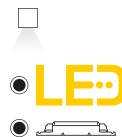



IP65

TWIST

Luminaria de pared LED de aluminio, para exterior con posibilidad de regular la iluminación hacia abajo o como iluminación indirecta hacia arriba.

TWIST MURO

230 V LED 12 W 3000 K 980 lm Ra 80 IP65

R13615 blanco

€ 98

R13616 gris antracita

€ 98

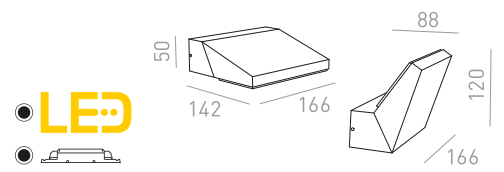

IP54



XYLO

Luminaria para exteriores LED. Provee la iluminación hacia abajo.

XYLO DE PARED

230 V LED 8 W 3000 K 590 lm Ra 80 IP54

R12562 gris antracita

€ 120

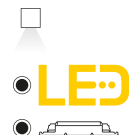
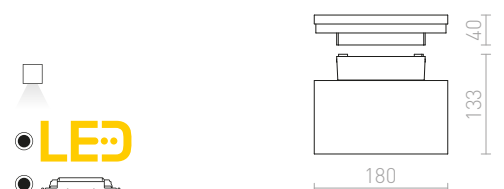



MIZZI

Luminaria de pared para exteriores, fabricada de aluminio fundido a presión, equipada con LED de 12 W de alto brillo. Transformador incluido.

MIZZI SQ I DE PARED

230 V LED 12 W $\angle 44^\circ$ 3000 K 846 lm Ra 80 IP54

R11964 gris antracita

€ 129 %

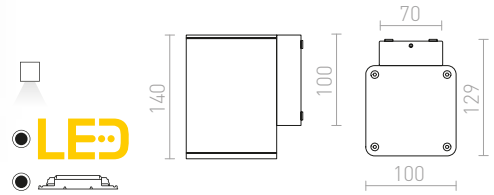

IP44

TELO

Aplique de pared para exteriores con cristal transparente. Iluminación de ARRIBA/ABAJO.

TELO DE PARED

230 V G9 40 W IP44

R10554 gris antracita

€ 68

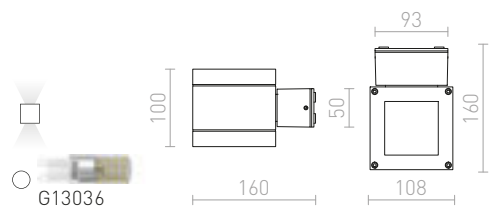

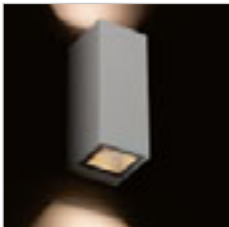

IP44

DESMOND

Aplique de pared para exterior de aluminio con iluminación ARRIBA/ABAJO para dos bombillas LED con casquillo GU10.

DESMOND II MURO

230 V GU10 2x35 W IP44

R13609 blanco

€ 68

R13610 gris plata

€ 68

R13611 gris antracita

€ 68

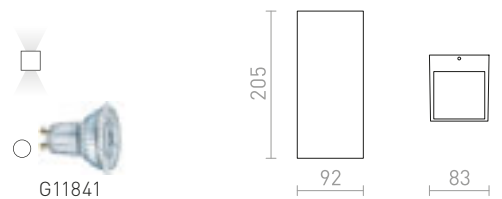

IP54

CABOX

Luminaria ARRIBA/ABAJO para exteriores. Adecuada para las fuentes de E27.

CABOX II DE PARED

230 V E27 70 W IP54

R10384 gris antracita

€ 88

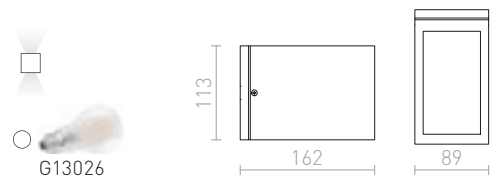



IP65



IP65

TITO

Lámpara LED de pared para iluminación ARRIBA/ ABAJO, con dos hojas metálicas para regular el haz de luz. Regulable TRIAC.

TITO R DIMM MONTADO EN LA PARED

230 V LED 2x3 W 3000 K 500 lm Ra 80 IP65

R13736 blanco

€ 88

R13737 negro

€ 88

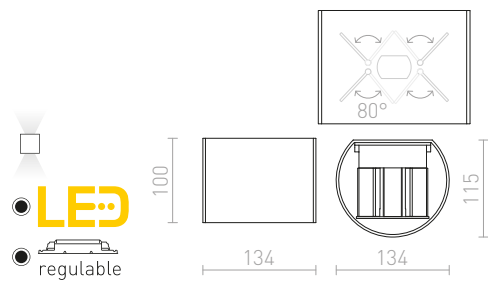

TITO SQ DIMM MONTADO EN LA PARED

230 V LED 2x3 W 3000 K 500 lm Ra 80 IP65

R13738 blanco

€ 88

R13739 negro

€ 88

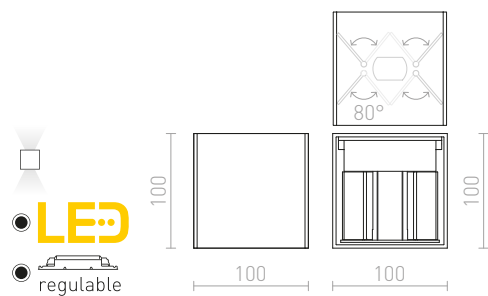



IP54

CARRE

Luminaria de pared angular LED para iluminación ARRIBA/ABAJO, con dos hojas metálicas para regular el haz de luz.

CARRE DE PARED

230 V LED 2x3 W 3000 K 200 lm Ra 80 IP54

R12556 blanco

€ 88

R12557 gris antracita

€ 88

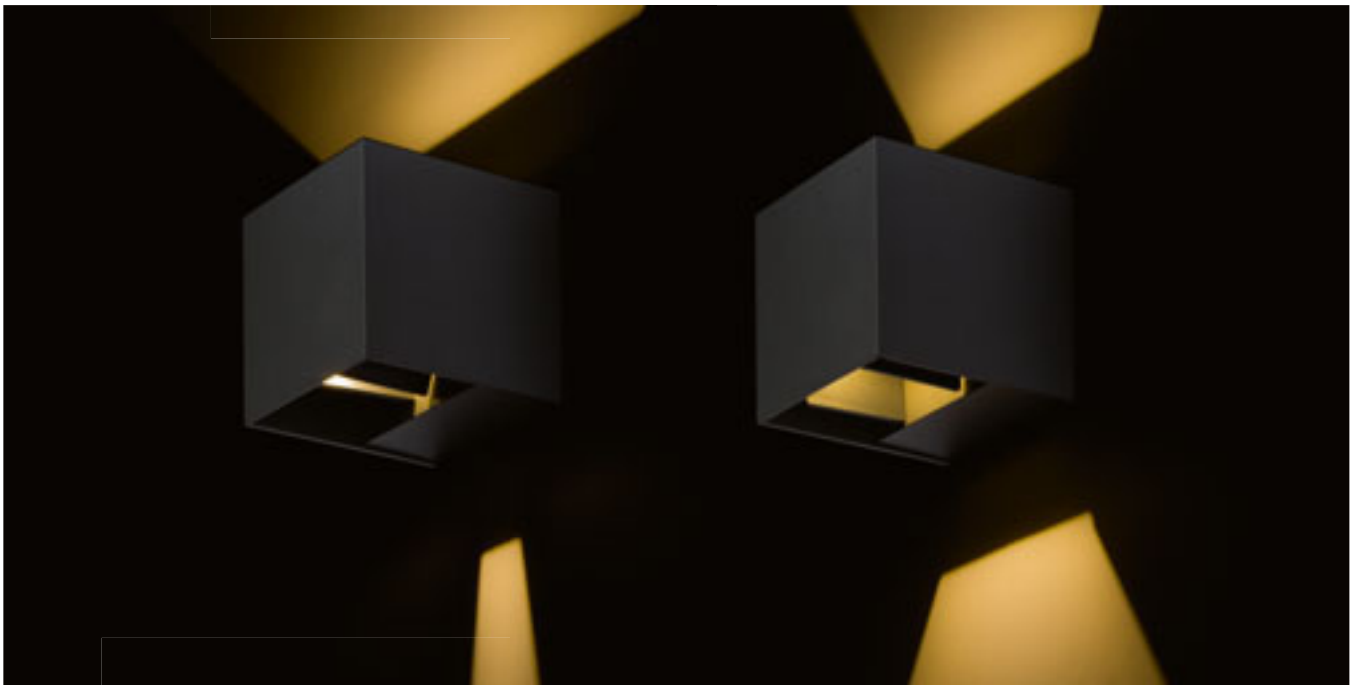
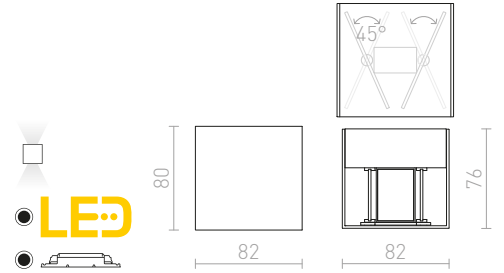

IP54

TITO

Lámpara LED de pared para iluminación ARRIBA/ABAJO, con dos hojas metálicas para regular el haz de luz.

TITO SQ DE PARED

230 V LED 6 W 3000 K 500 lm Ra 80 IP54

R12601 aluminio cepillado

€ 78

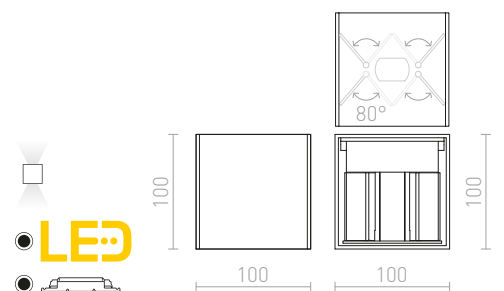





GRANITA

Aplique de exterior hecho de hormigón para fuentes de luz LED con casquillo GU10.

GRANITA II DE PARED

230 V LED GU10 2x5 W IP65

R13792 hormigón/decoración de granito claro € 120

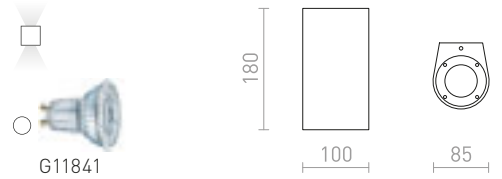

IP65



KANE

Aplique de exterior de hormigón para fuentes de luz LED con casquillo GU10.

KANE I DE PARED

230 V LED GU10 5 W IP65

R13793 hormigón/decoración de granito oscuro € 88

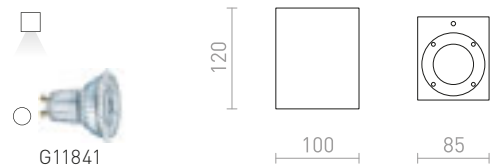

IP65

KANE II DE PARED

230 V LED GU10 2x5 W IP65

R13794 hormigón/decoración de granito oscuro € 120

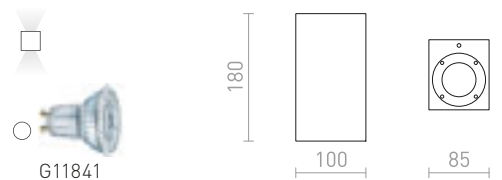



IP54



IP65

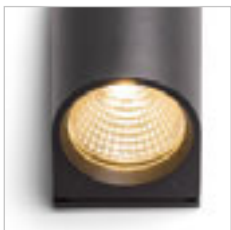

PIA

Lámpara de pared LED. Iluminación ARRIBA/ABAJO.
Fabricada de aluminio fundido a presión.

PIA DE PARED

230 V LED 2x3 W 3000 K 270 lm Ra 80 IP54

R12010 gris antracita

€ 68

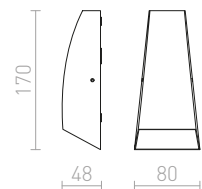
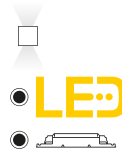

ZAZA

Lámpara de pared para exteriores. LLeva un cristal transparente.

ZAZA DE PARED

230 V LED 3,3 W 3000 K 250 lm Ra 80 IP65

R10398 gris antracita

€ 78 %

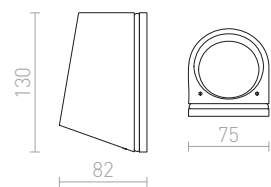
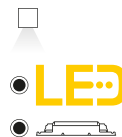

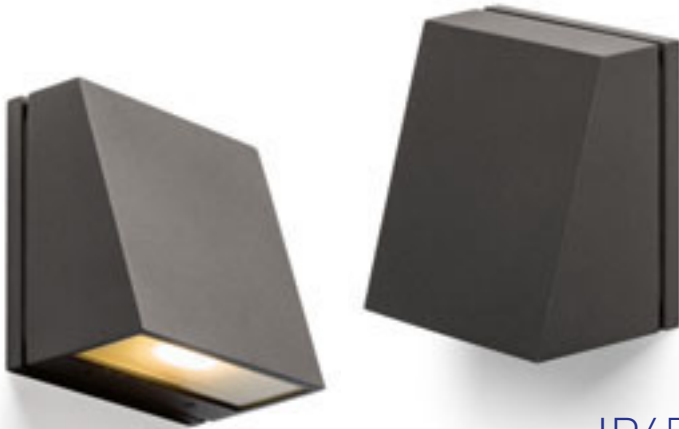

IP65

GIGI

Lámpara de pared para exteriores. Lleva un cristal de protección mate.

GIGI DE PARED

230 V LED 3,3W 3000 K 250 lm Ra 80 IP65

R10399 gris antracita

€ 98

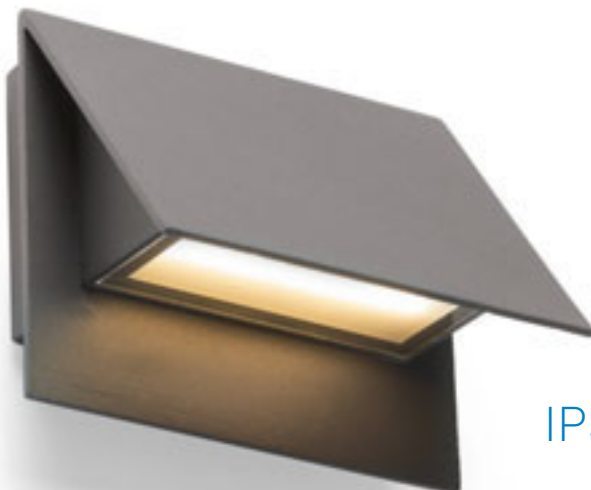
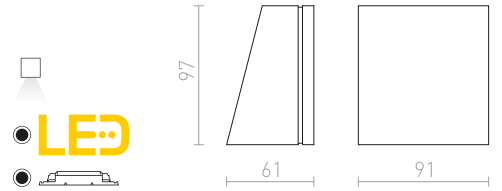

IP54

GERI

Luminaria de pared LED de aluminio para exterior con iluminación descendente.

GERI DE PARED

230 V LED 5W 3000 K 211 lm Ra 80 IP54

R13561 gris antracita

€ 88

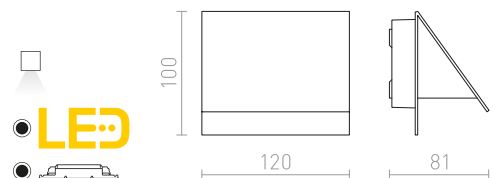

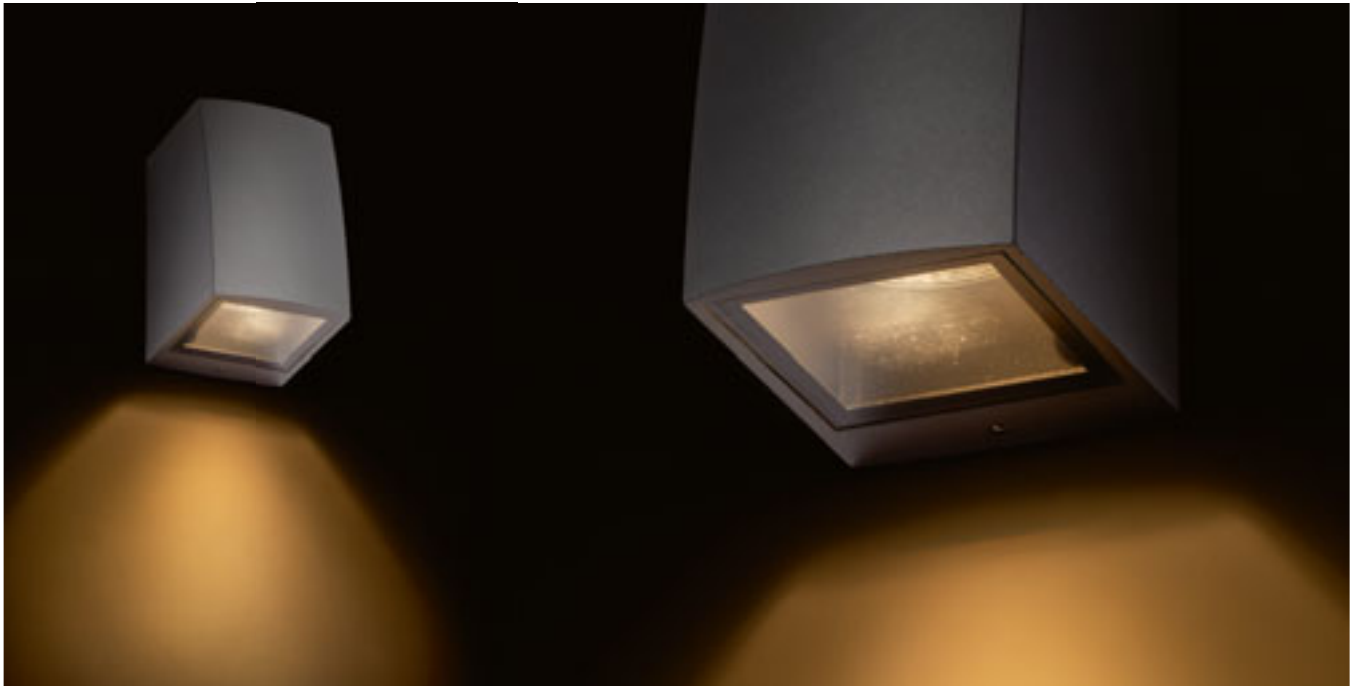

IP54

SELMA

Aplique de aluminio para exteriores con casquillos GU10.

SELMA DE PARED

230 V GU10 35 W IP54

R13513 blanco

€ 35

R13514 gris plata

€ 35

R13515 gris antracita

€ 35



G11837

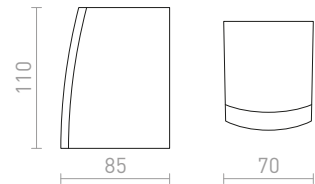

IP54

SIV

Lámpara de techo redonda con LED incorporado e iluminación hacia abajo. Adecuada para pasillos.

SIV MONTADO EN LA SUPERFICIE

230 V LED 6 W $\angle 120^\circ$ 3000 K 360 lm Ra80 IP54

R13502 gris antracita

€ 78

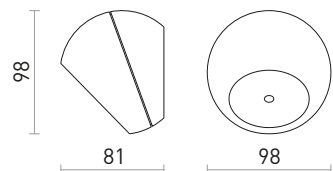



IP54

BOURDON

Aplique de pared para exteriores con casquillo para fuentes de luz GU10. El cuerpo de la luminaria está fabricado en aluminio laqueado fundido a presión.

BOURDON DE PARED

230 V GU10 35 W IP54

R13559 gris antracita

€ 48

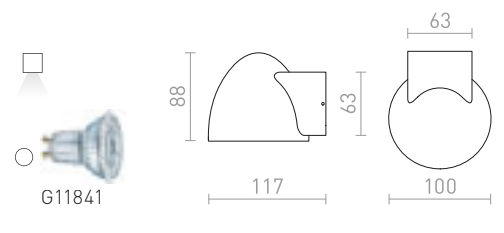

IP54

PIPER

Aplique de pared para exteriores con LED tubular incorporado e iluminación descendente.

PIPER DE PARED

230 V LED 6 W 3000 K 489 lm Ra 80 IP54

R13560 gris antracita

€ 78

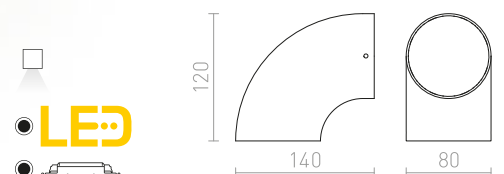



IP54



IP54



ZACK

Luminaria LED de pared para exteriores. Hecha de aluminio a presión.

ZACK II

230 V LED 2x3 W $\angle 58^\circ$ 3000 K 315 lm Ra 80 IP54

R12022 gris antracita

€ 78

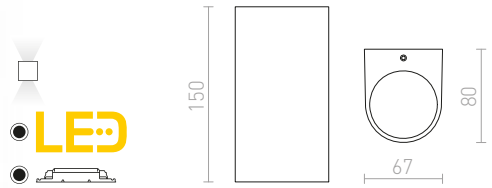

ZACK I

230 V LED 3 W $\angle 58^\circ$ 3000 K 176 lm Ra 80 IP54

R12027 gris antracita

€ 58

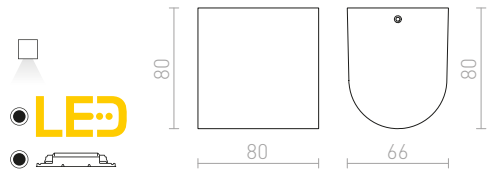

IP54

MIDZACK

Lámpara redonda LED para iluminación ARRIBA/ ABAJO.

MIDZACK DE PARED

230 V LED 2x3 W 3000 K 480 lm Ra 80 IP54

R12585 blanco

€ 88

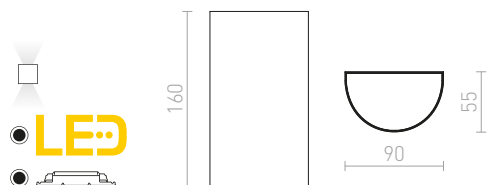



IP65

BEJA

Luminaria de pared para exteriores, de iluminación ARRIBA/ABAJO fabricada en aluminio fundido a presión. La luminaria está equipada con LED de alta potencia.

BEJA II DE PARED

230 V LED 2x9 W $\angle 24^\circ$ 3000 K 670 lm Ra 80 IP65

R13757 gris antracita

€ 138

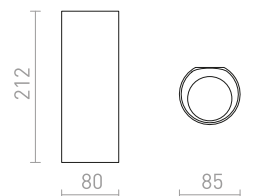
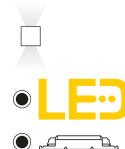



IP54

KUBI

Lámpara LED de pared para exteriores, fabricada de aluminio fundido a presión.

KUBI I

230 V LED 3 W $\angle 56^\circ$ 3000 K 176 lm Ra 80 IP54

R12021 gris antracita

€ 58

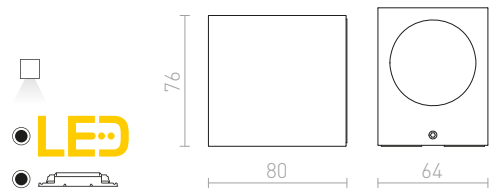

IP54

KUBI II

230 V LED 2x3 W $\angle 56^\circ$ 3000 K 315 lm Ra 80 IP54

R12028 gris antracita

€ 68

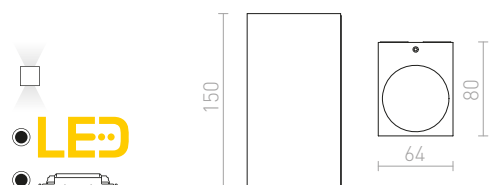

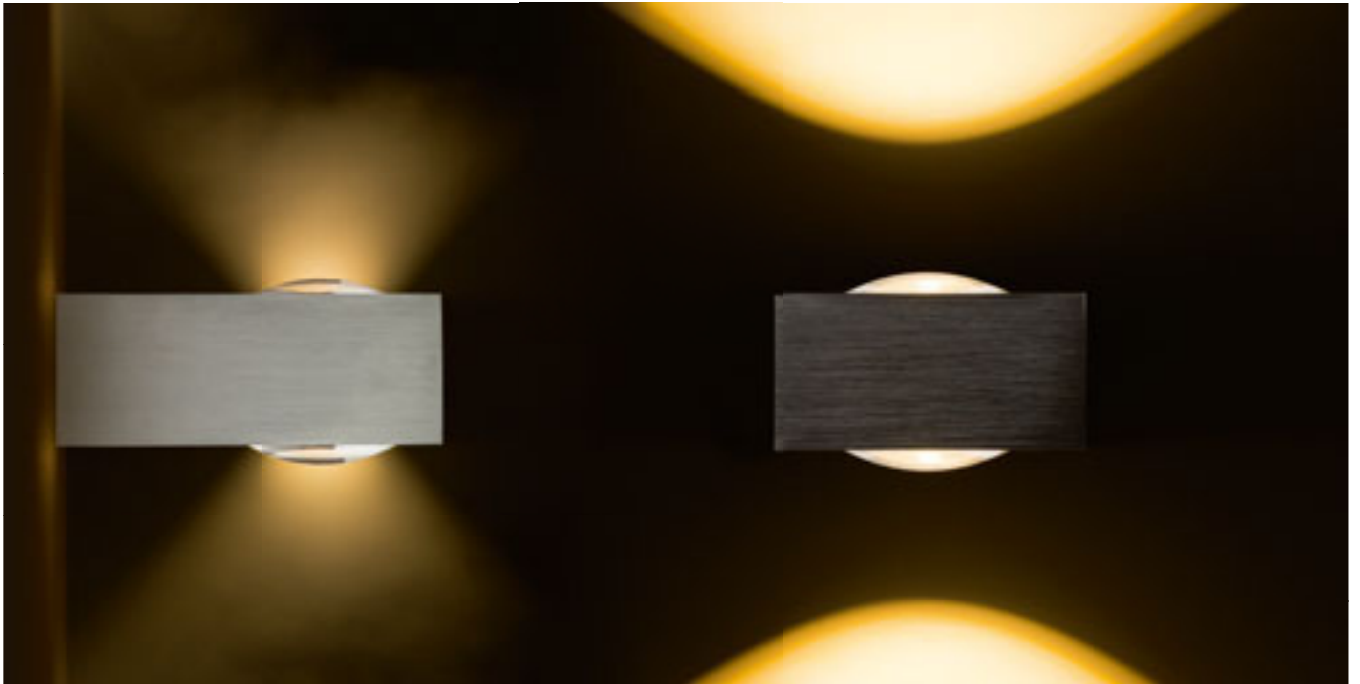

IP54

KORSO

Luminaria LED de pared. Adecuada para el uso en interiores y exteriores. Hecha de aluminio anodizado natural o negro.

KORSO II DE PARED

230 V LED 2x3 W $\angle 120^\circ$ 3000 K 780 lm Ra 80 IP54

R12831 aluminio cepillado

€ 68 %

R12832 anodizado preto

€ 68 %

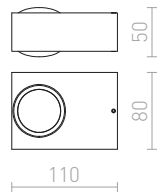

IP54

KORSO I DE PARED

230 V LED 5 W $\angle 120^\circ$ 3000 K 390 lm Ra 80 IP54

R12829 aluminio cepillado

€ 58 %

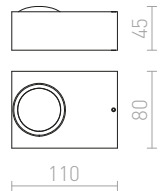

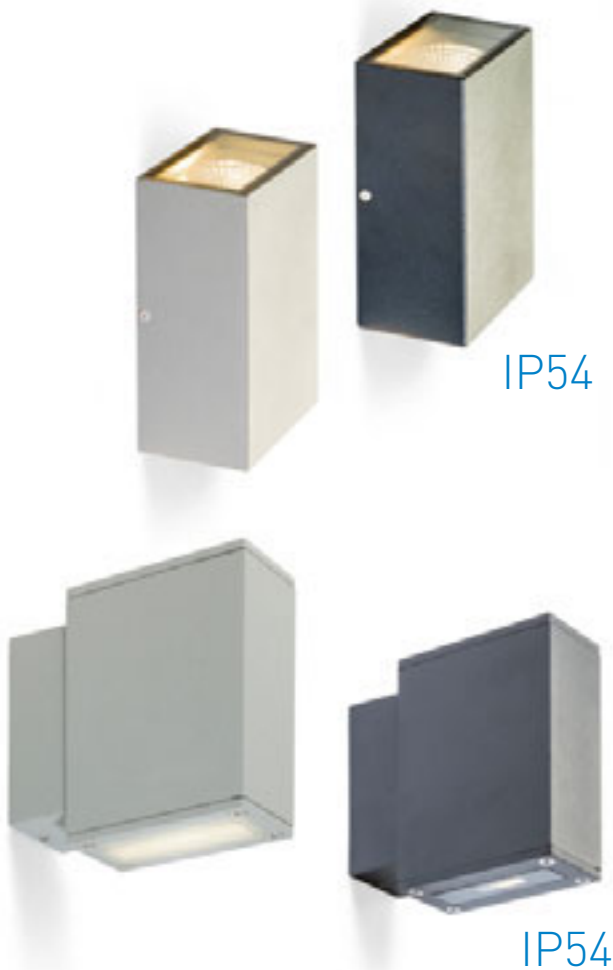

DIXIE

Luminaria ARRIBA/ABAJO de pared exterior hecha de aluminio presurizado. La luminaria está equipada con LED CREE de alto rendimiento.

DIXIE 10x16 DE PARED

230V LED 2x5W $\angle 84^\circ$ 3000 K 550lm Ra80 IP54

R10352 blanco

€ 68

%

R10353 negro

€ 68

%

R10354 gris plata

€ 68

%

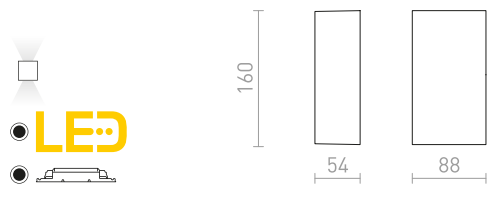

DIXIE 4x12 DE PARED

230V/700mA LED 2x3W $\angle 48^\circ$ 3000 K 360lm Ra80 IP54

R10355 negro

€ 98

→

R10356 gris plata

€ 48

%

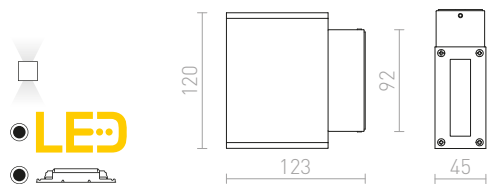

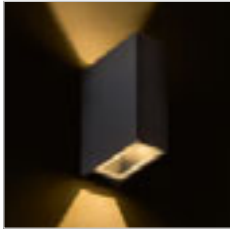

IP54

UKKO

Luminaria de pared LED empotrable para exteriores con iluminación ARRIBA/ABAJO.

UKKO DE PARED

230 V LED 2x3 W $\angle 55^\circ$ 3000 K 180 lm Ra 80 IP54

R12555 negro

€ 120

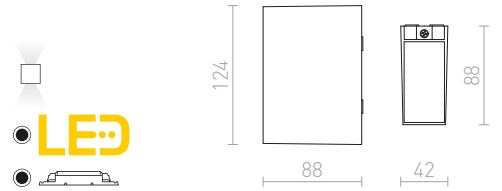

IP54

PEKKO

Luminaria de pared LED rectangular para iluminación unidireccional.

PEKKO DE PARED

230 V LED 3 W $\angle 67^\circ$ 3000 K 86 lm Ra 80 IP54

R12552 blanco

€ 78

R12553 negro

€ 78

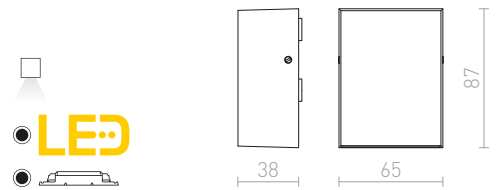

IP54

NICK

Lámpara de pared LED con iluminación ARRIBA/ABAJO, adecuada para el uso en interiores y exteriores.

NICK II DE PARED

230 V LED 2x3 W $\angle 10^\circ$ 3000 K 780 lm Ra 80 IP54

R12827 aluminio cepillado

€ 68

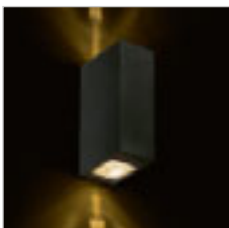
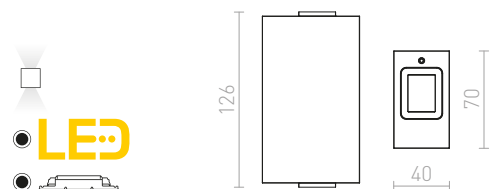



IP54

ZANE

Tubo LED minimalista montado en una base cuadrada con iluminación ARRIBA/BAJO, adecuado para exteriores.

ZANE DE PARED

230 V LED 2x3 W $\angle 60^\circ$ 3000 K 300 lm Ra 80 IP54

R12960 níquel mate

€ 58 %

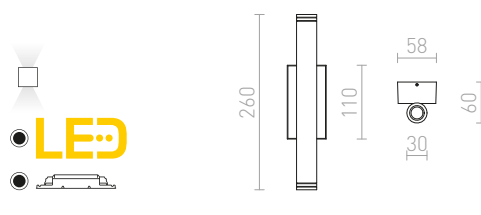

IP54

MICO

Aplique de aluminio fundido a presión con reflector fijo para iluminación unidireccional.

MICO I DE PARED

230 V GU10 35 W IP54

R10170 aluminio

€ 58 %

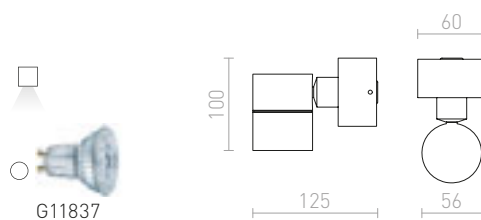



IP54



IP54

MOIRE

Lámpara de pared hecha de aluminio natural con cubiertas de vidrio.

MOIRE I DE PARED
230 V GU10 35 W IP54

R10133 aluminio

€ 48 %

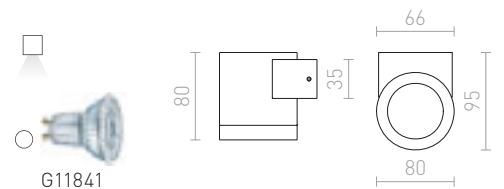

MOIRE II DE PARED
230 V G9 25 W IP54

R10132 aluminio

€ 68 %

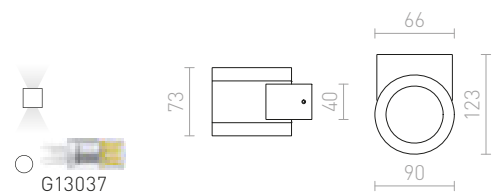



IP54



MORA

Lámpara de pared para exteriores, con casquillo E27. Provee una iluminación suave y adecuada para terrazas y entradas de casa.

MORA DE PARED
230 V E27 18 W IP54

R12571 gris plata

€ 48 %

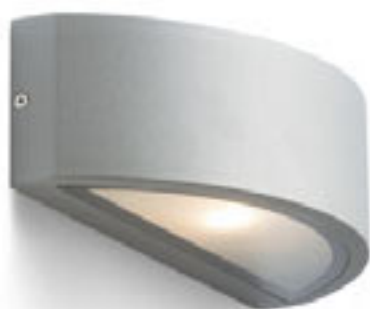
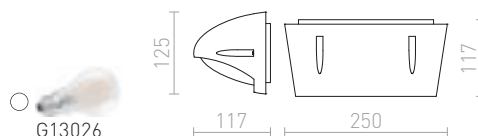

IP54



LESA

Luminaria de pared para exteriores. Fabricada de aluminio presurizado en tres variantes de color. Una tapa de metal evita que la luz ilumine arriba.

LESA DE PARED
230 V E27 26 W IP54

R10364 negro

€ 88

R10365 blanco

€ 88

R10366 gris plata

€ 88

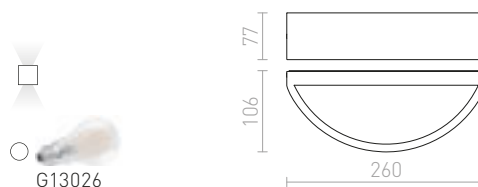



IP54



IP54

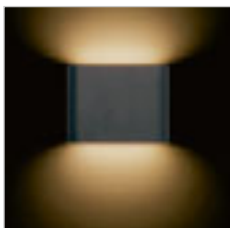

CHOIX

Lámpara de pared ARRIBA/ABAJO delgada de aluminio fundido a presión para el uso en exteriores.

CHOIX 114 DE PARED

230 V LED 2x3 W 3000 K 318 lm Ra 80 IP54

R12012 gris antracita

€ 68



LED

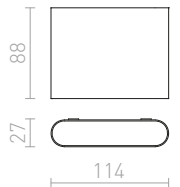

CHOIX 175 DE PARED

230 V LED 10 W 3000 K 660 lm Ra 80 IP54

R12691 gris antracita

€ 78



LED

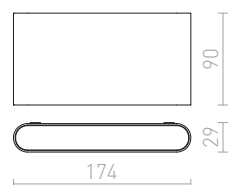



IP65



FOX

Reflector LED ajustable para exteriores, con cristal transparente para el montaje en la pared. Para una posible instalación en el jardín, es posible ensamblar con la espiga para el suelo (R11755).

FOX REFLECTOR EXTERIOR

230 V LED 9 W $\angle 120^\circ$ 3000 K 900 lm Ra 80 IP65

R11753 gris antracita

€ 178

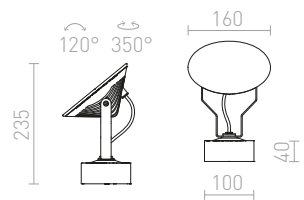

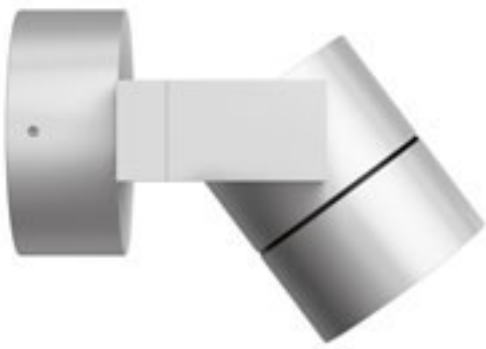

IP44

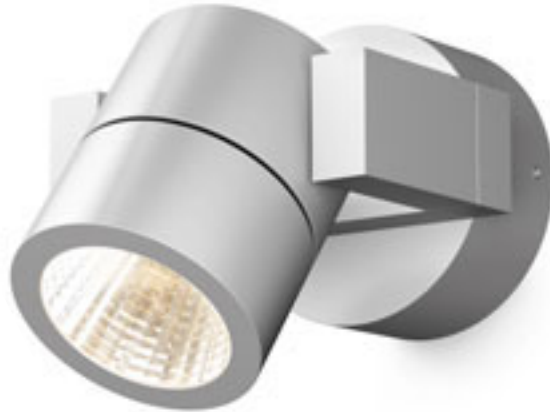

ORIT

Foco de aluminio para exteriores con función de inclinación, tiene LED integrado de 6W. El foco puede inclinarse solamente en un eje.

ORIT DE PARED

230 V LED 6 W $\angle 80^\circ$ 3000 K 315 lm Ra 80 IP44

R12033 aluminio

€ 78 ➔

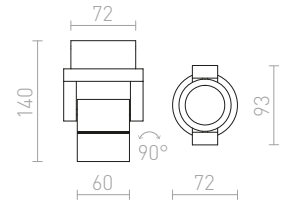
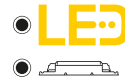

IP54

DIREZZA

Foco para exteriores. El reflector puede inclinarse al desajustar el tornillo en la base.

DIREZZA DE PARED

230 V GU10 35 W IP54

R10388 gris plata

€ 58

R10432 gris antracita

€ 58



G11837

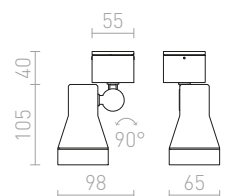





IP54

BORA

Reflector LED cuadrático de diodos para montaje en pared.

BORA DE PARED

230 V LED 6 W $\angle 44^\circ$ 3000 K 355 lm Ra 80 IP54

R12578 gris antracita

€ 98

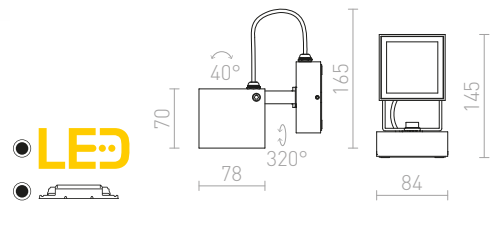

IP54

PONTA

Reflector LED plano de gran alcance en negro con sensor de movimiento. El cable no está provisto de enchufe.

PONTA REFLECTOR CON SENSOR

230 V LED 30 W $\angle 120^\circ$ 3000 K 2700 lm Ra 80 IP54

R12982 negro

€ 68

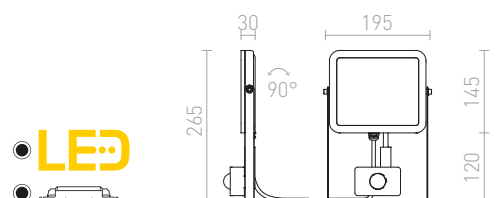



IP65

BLUESTAR

Reflector exterior de aluminio con espiga para bombilla LED con casquillo GU10, marco frontal de acero inoxidable. Incluye un cable de 1 m sin enchufe.

BLUESTAR EN ESTACA

230 V GU10 35 W IP65

R13630 gris antracita

€ 78

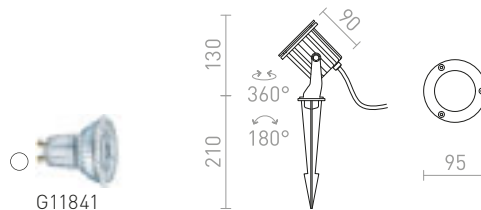

IP65

GUN

Mini reflector LED al aire libre con una espiga al suelo. Incluye un cable de 1 m sin enchufe.

GUN EN ESTACA

230 V LED 3x1 W $\angle 30^\circ$ 3000 K 210 lm Ra 80 IP65

R10530 negro

€ 48

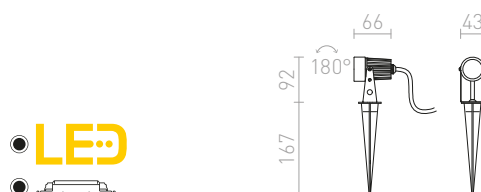



DIREZZA

Foco para exteriores. El reflector puede inclinarse al desajustar el tornillo en la base.

DIREZZA EN ESTACA

230 V GU10 35 W IP54

R10427 gris plata

€ 68

R10431 gris antracita

€ 68



CORDOBA

Foco para exteriores para la fuente de luz GU10. Se suministra con un cable sin enchufe.

CORDOBA EN ESTACA

230 V GU10 35 W IP54

R12579 gris antracita

€ 68

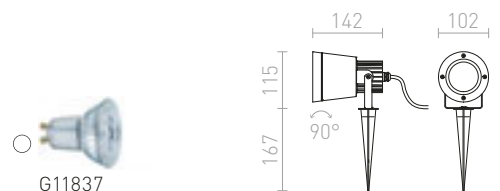



IP65

LORCA

Mini foco LED de exterior con espiga para instalación en suelo. Incluye cable de alimentación de un metro. El cable no incluye enchufe.

LORCA EN ESTACA

230 V LED 5W 3000 K 316 lm Ra80 IP65

R13568 gris antracita

€ 120

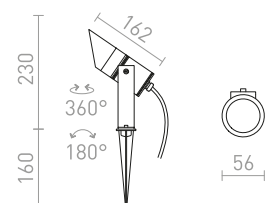



IP65

GARY

Reflector LED para exteriores con una espiga para instalación en suelo. Incluye un cable de 1 m sin enchufe.

GARY LED EN ESTACA

230 V LED 10 W $\angle 45^\circ$ 3000 K 900 lm Ra 80 IP65

R10527 gris

€ 88

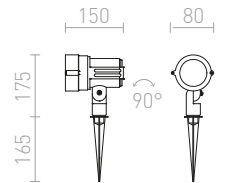

IP54

BORA

Reflector de diodo LED cuadrático para exteriores. Incluye un 1m de cable sin enchufe.

BORA EN ESTACA

230 V LED 6 W $\angle 50^\circ$ 3000 K 340 lm Ra 80 IP54

R12025 gris antracita

€ 98

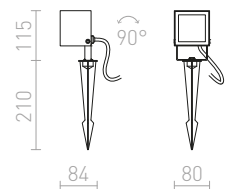

IP65

COSMO

Reflector LED al aire libre con una espiga para instalación en suelo. Se suministra con un cable sin enchufe.

COSMO EN ESTACA

230 V LED 10 W $\angle 24^\circ$ 3000 K 850 lm Ra 80 IP65

R12580 gris antracita

€ 98

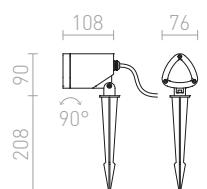



IP65

HEAVY DUTY

Reflector de aluminio sólido para exteriores. La luminaria se suministra con un cable de 1,5 m sin enchufe. Posibilidad de completar con la espiga para instalación en el suelo (R11755).

HEAVY DUTY REFLECTOR EXTERIOR

230 V GU10 50 W IP65

R11948 gris antracita

€ 68

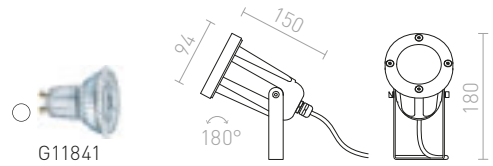

IP65

FOX

Reflector LED ajustable para exteriores, con cristal transparente para el montaje en la pared. Para una posible instalación en el jardín, es posible ensamblar con la espiga para el suelo (R11755).

FOX REFLECTOR EXTERIOR

230 V LED 9 W $\angle 120^\circ$ 3000 K 900 lm Ra 80 IP65

R11753 gris antracita

€ 178

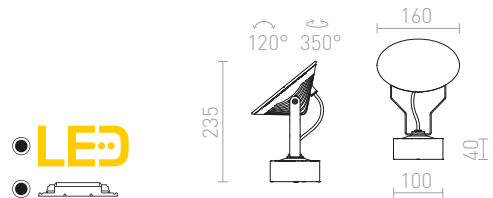

IP65

ROSS

Reflector LED ajustable para exteriores con cubierta de vidrio satinado y opción de ángulo de luz de 8-30°. Para el jardín, es posible ensamblar con la espiga para el suelo (R11755). Se suministra sin el cable de alimentación.

ROSS REFLECTOR EXTERIOR

230 V LED 9 W $\angle 30^\circ$ 3000 K 900 lm Ra 80 IP65

R11754 gris antracita

€ 178

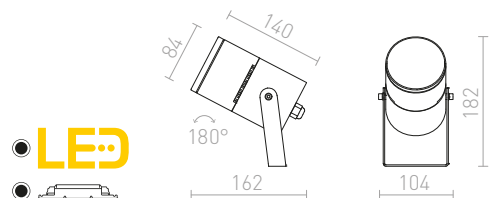



ESPIGA

Espiga universal para las luminarias de exteriores. El punto se puede sujetar a la rosca M10 * 1 o se puede fijar mediante un tornillo en el soporte.

ESPIGA UNIVERSAL SUELO

R11755 negro

€ 12

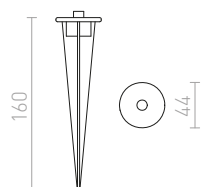



IP67



IP67

TOPTOP

Luminaria de suelo LED con viseras para el montaje en baldosas sin necesidad de empotrar.

TOPTOP S I

230 V LED 1,5 W 3000 K 105 lm Ra 80 IP67

R13617 gris antracita

€ 88

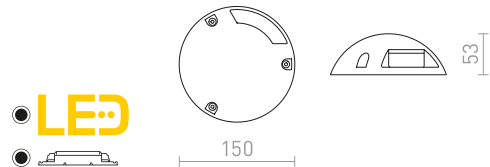

TOPTOP S III

230 V LED 3x1 W 3000 K 210 lm Ra 80 IP67

R13618 gris antracita

€ 88

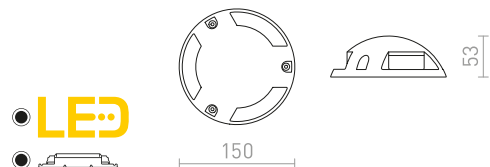



IP54

FAROS

Luminaria LED para exteriores. Ilumina el alrededor. Fabricada de aluminio fundido a presión. La lámpara se puede usar tanto en la pared como sobre un soporte.

FAROS EXTERIOR

230 V LED 3 W 3000 K 154 lm Ra 80 IP54

R11963 gris antracita

€ 120

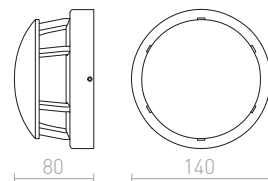

IP67

TOPTOP

Luminaria LED con 4 pantallas traslúcidas. Sin la necesidad de inserción al suelo. Para el jardín, es posible ensamblar con la espiga para el suelo (R11755).

TOPTOP IV SUELO

230 V LED 4x1 W 3000 K 400 lm Ra 80 IP67

R11751 gris antracita

€ 158

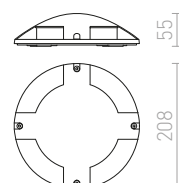

ESPIGA

Espiga universal para las luminarias de exteriores. El punto se puede sujetar a la rosca M10 * 1 o se puede fijar mediante un tornillo en el soporte.

ESPIGA UNIVERSAL SUELO

R11755 negro

€ 12

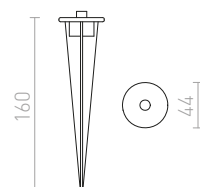



IP65

BOBO

Lámpara de superficie de aluminio con LED incorporado, apta para la iluminación de caminos y escalones. Para uso en exteriores. No necesita ser empotrada.

BOBO R DE PARED

230 V LED 3 W 3000 K 212 lm Ra80 IP65

R13933 gris antracita

€ 48 **NEW**

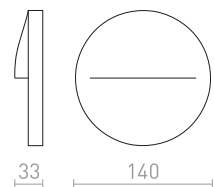



IP65



BOBO

Lámpara de superficie de aluminio con LED incorporado, apta para la iluminación de caminos y escalones. Para uso en exteriores. No necesita ser empotrada.

BOBO RC DE PARED

230V LED 8W 3000K 640lm Ra80 IP65

R13934 gris antracita

€ 58 **NEW**

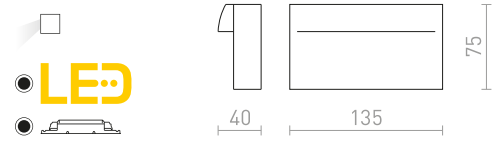

IP65



BOBO

Lámpara de superficie de aluminio con LED incorporado, apta para la iluminación de caminos y escalones. Para uso en exteriores. No necesita ser empotrada.

BOBO SQ DE PARED

230V LED 3W 3000K 135lm Ra80 IP65

R13935 gris antracita

€ 48 **NEW**

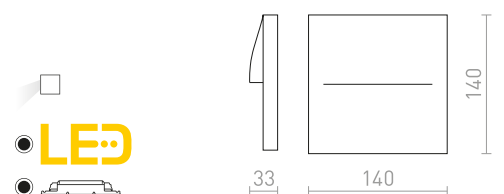



IP65

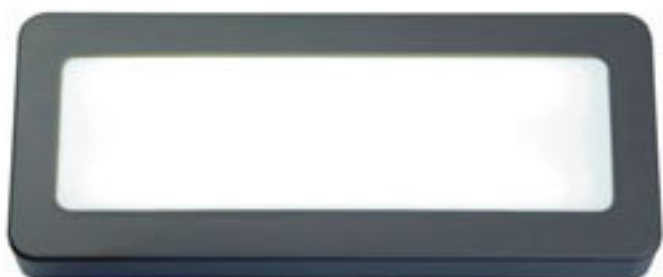

RENO

Luminaria de pared LED, para exteriores. Hecha de plástico resistente con el transformador integrado.

RENO SQ DR MONTADAS EN SUPERFICIE

230 V LED 5 W 3000 K 450 lm Ra 80 IP65

R11951 gris

€ 48 →

R11954 gris antracita

€ 48 →

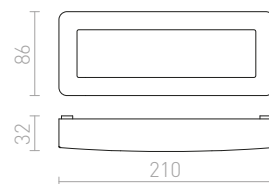

IP65



RENO

Lámpara LED de pared, de plástico. Para uso en exteriores. Incluye un transformador incorporado. Disponible en dos colores diferentes. Sirve para iluminación hacia abajo.

RENO R DE PARED

230 V LED 2 W 3000 K 180 lm Ra 80 IP65

R11949 gris

€ 32 →

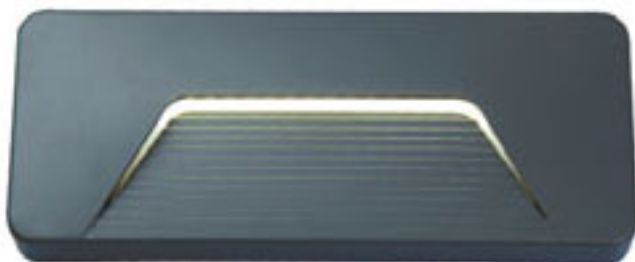
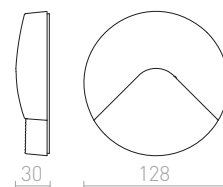
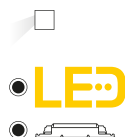

IP65

RENO SQ INDR DE PARED

230 V LED 3 W 3000 K 280 lm Ra 80 IP65

R11950 gris

€ 38 →

R11953 gris antracita

€ 38 →

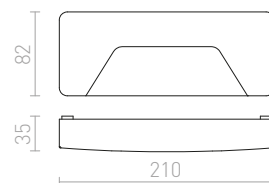
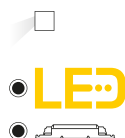





IP54



ITAKA

Luminaria de pared para exteriores con iluminación hacia abajo. Adecuada para la iluminación de escaleras y caminos.

ITAKA DE PARED

230 V LED 2 W 3000 K 180 lm Ra 80 IP54

R10379 gris plata

€ 48 %

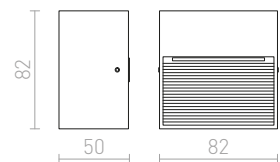
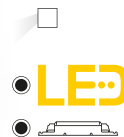



IP54

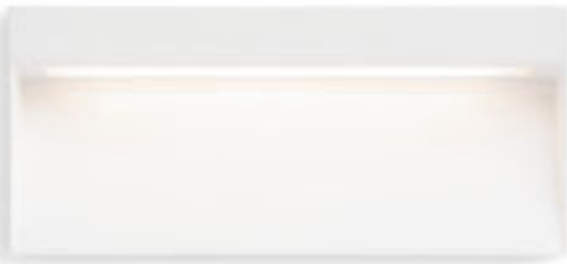

IP54



IP54

AQILA

Luminaria LED de pared para la iluminación orientativa en pavimentos, escaleras o terrazas. Adecuada para el uso en interiores y exteriores sin la necesidad de ser empotrada.

AQILA R DE PARED

230 V LED 6 W 3000 K 200 lm Ra 80 IP54

- R12539 blanco € 88
- R12540 gris € 78
- R12541 gris antracita € 88

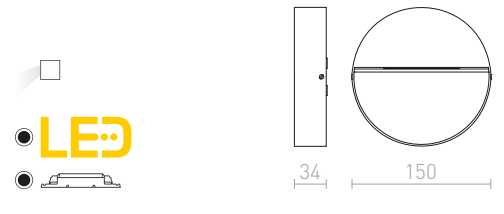

AQILA RC DE PARED

230 V LED 6 W 3000 K 200 lm Ra 80 IP54

- R12545 blanco € 88
- R12547 gris antracita € 98

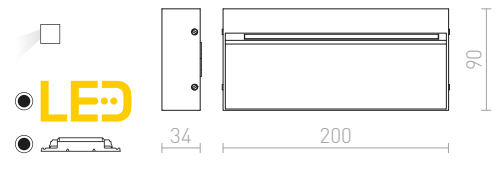

AQILA SQ DE PARED

230 V LED 6 W 3000 K 200 lm Ra 80 IP54

- R12542 blanco € 88
- R12544 gris antracita € 88

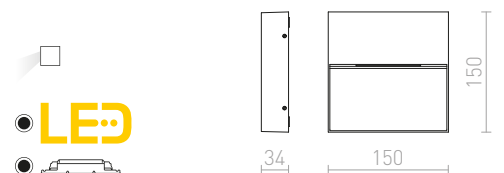





IP54



IP54



IP54

KICK

Luminaria empotrada de orientación con LED integrado que emite luz a uno, dos o tres lados. Diseñado para instalaciones en pared.

KICK I EMPOTRADA

230 V LED 3 W 3000 K 100 lm Ra 80 IP54

R12613 blanco

€ 48

R12615 negro

€ 48

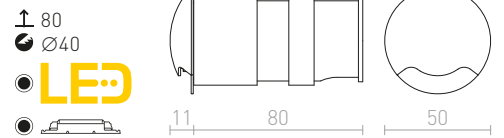

KICK II EMPOTRADA

230 V LED 3 W 3000 K 120 lm Ra 80 IP54

R12616 blanco

€ 48

R12618 negro

€ 48

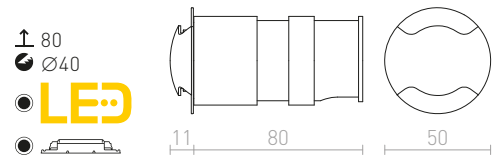

KICK III EMPOTRADA

230 V LED 3 W 3000 K 150 lm Ra 80 IP54

R12619 blanco

€ 48

R12621 negro

€ 48

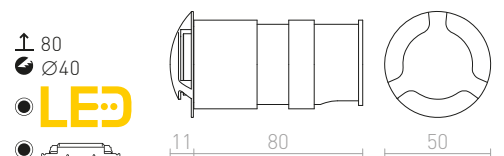



IP54



IP54



IP54



CLUB

Aplique LED cálido, brinda luz orientativa en pasillos y escaleras.

CLUB IND EMPOTRADA

230 V LED 3 W 3000 K 270 lm Ra 80 IP54

R12686 gris plata

€ 48

↑ 90
● Ø56



● LED

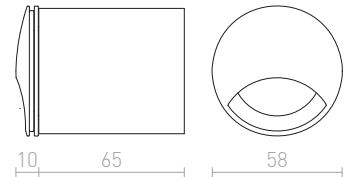
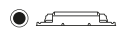

CLUB EMPOTRADA

230 V LED 3 W 3000 K 270 lm Ra 80 IP54

R12685 gris plata

€ 48

↑ 90
● Ø57

● LED

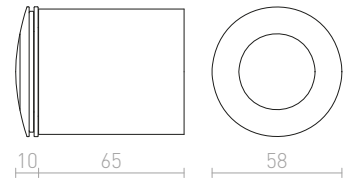
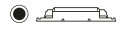

ELICA

Luminaria empotrada redonda de aluminio con la fuente de luz LED integrada. Se suministra con la caja de montaje.

ELICA R EMPOTRADA

230 V LED 3 W 3000 K 75 lm Ra 80 IP54

R12528 aluminio cepillado

€ 58 %

↑ 95
● Ø75



● LED

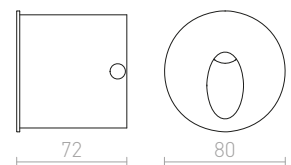



IP54

MARCO LED

Aplicación redonda empotrada adecuada tanto para uso interior como exterior. Instalar sólo para iluminación hacia abajo. Caja de montaje incluida.

MARCO EMPOTRADA

230 V LED 3 W 3000 K 80 lm Ra 80 IP54

R12024 blanco € 48

R12029 gris plata € 48

R12030 gris antracita € 48

↑ 60
 ⚙ Ø76



LED

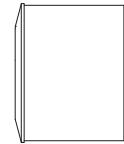

56

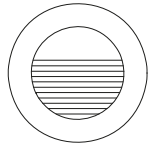

78



IP54



ASTERIA

Luminaria empotrada de pared para exteriores. La abertura visible tiene una profundidad de 3 cm. Instalar sólo para iluminación hacia abajo.

ASTERIA EMPOTRADA

230 V LED 3 W 3000 K 180 lm Ra 80 IP54

R10558 gris plata € 58

↑ 75
 ⚙ Ø113



LED

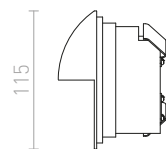

115

32 58

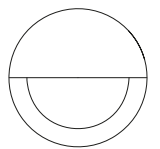

115

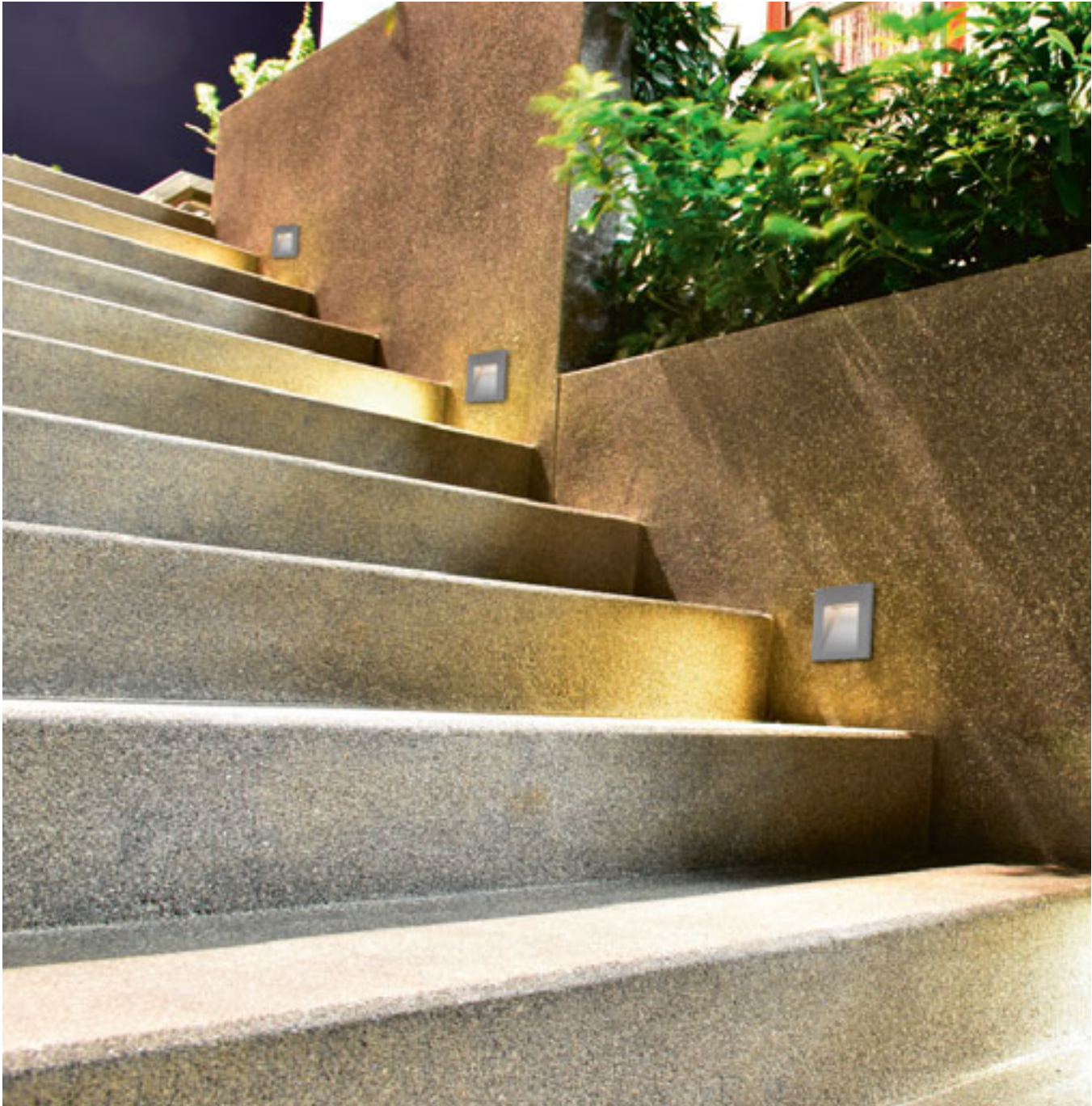

IP54

TESS

Aplique empotrable cuadrado apto para exterior e interior en tres colores. Incluye caja de montaje. Instalación sólo con iluminación hacia abajo.

TESS SQ EMPOTRADA

230 V LED 3 W 3000 K 80 lm Ra 80 IP54

R12013	blanco	€ 58
R12014	gris plata	€ 58
R12015	gris antracita	€ 58

± 70
60x55



LED

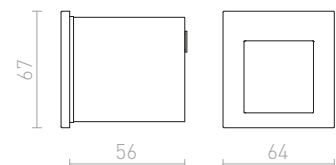



IP65



RASQ

Empotrable LED. Para la iluminación orientativa de pavimentos, escaleras o terrazas. Adecuado para el uso en interiores y exteriores. Instalar sólo para iluminación hacia abajo.

RASQ EMPOTRADA AL MURO

230 V LED 9 W 3000 K 190 lm Ra 80 IP65

R12627 blanco

€ 178

R12628 gris antracita

€ 178

↑ 80

▣ 237x77



LED

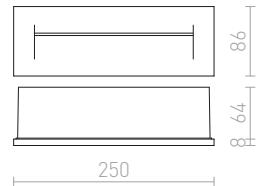

PER

Luminaria LED empotrable, adecuada para el uso en interiores y exteriores. Sirve para la iluminación orientativa en pavimentos, escaleras o terrazas.

PER EMPOTRADA

230 V LED 3 W 3000 K 76 lm Ra 80 IP54

R12576 blanco

€ 58

R12577 gris antracita

€ 58

↑ 60

▣ 65x102



LED

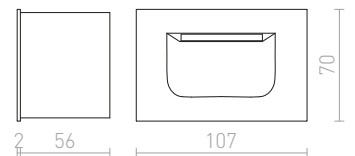

IP54



ELICA

Luminaria empotrada redonda de aluminio con la fuente de luz LED integrada. Se suministra con la caja de montaje.

ELICA SQ EXTERIOR

230 V LED 3 W 3000 K 180 lm Ra 80 IP54

R10639 níquel mate

€ 35

R12529 aluminio cepillado

€ 58

↑ 70

⊘ Ø75



LED

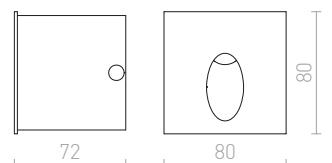

IP54



IP65



IP65



IP65



GORDIQ

Luminaria empotrable LED para la iluminación direccional de pavimentos, escaleras o terrazas. Instalar sólo iluminando hacia abajo.

GORDIQ S EMPOTRADA

230 V LED 1,5 W 3000 K 30 lm Ra 80 IP65

R12533 blanco

€ 58

R12534 gris antracita

€ 58

↑ 60
↙ 75x72



● LED

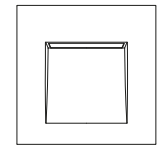
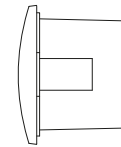

90

12 59

90

GORDIQ M EMPOTRADA

230 V LED 3 W 3000 K 90 lm Ra 80 IP65

R12535 blanco

€ 88

R12536 gris antracita

€ 88

↑ 60
↙ 115x108



● LED

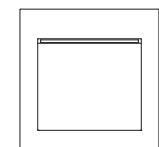
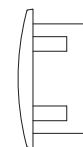

140

15 60

140

GORDIQ L EMPOTRADA

230 V LED 3 W 3000 K 90 lm Ra 80 IP65

R12537 blanco

€ 68

R12538 gris antracita

€ 68

↑ 60
↙ 115x50



● LED

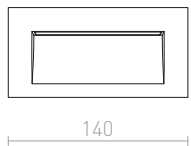
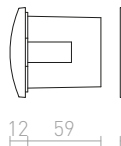

70

12 59

140



IP65

RAGG

Luminaria empotrable de exterior con luz direccional para iluminar aceras y escaleras.

RAGG EMPOTRADO

230V LED 12W 3000K 406lm Ra80 IP65

R13620 blanco

€ 120

R13621 negro

€ 120



↑ 80

⚡ 80x230



LED

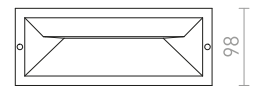
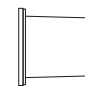

5 85

250

98





IP65



IP65

DEJAVU

Luminaria LED empotrable para el montaje en pared. Apta para la iluminación direccional de pavimentos, escaleras o terrazas.

DEJAVU SQ 9 EMPOTRADA

230 V LED 3,5 W 3000 K 120 lm Ra 80 IP65

R12530 negro

€ 58 %

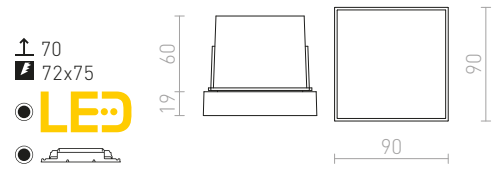

DEJAVU SQ 14 EMPOTRADA

230 V LED 6 W 3000 K 270 lm Ra 80 IP65

R12531 negro

€ 78 %

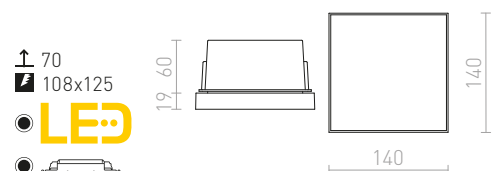



IP54



SEGNO

Luminaria LED exterior empotrable en pared con una emisión decente a través de una rendija estrecha.

SEGNO EMPOTRADO

230 V LED 3 W 3000 K Ra 80 IP54

R13566 blanco

€ 98

R13567 gris antracita

€ 98

↑ 70
172x62



LED

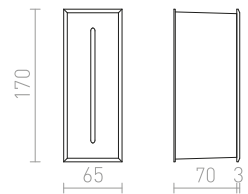
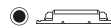

IP54



FACA

Luminaria de exterior montada en la pared. El marco visible tiene una profundidad de 2 cm. Instalar iluminando hacia abajo.

FACA EMPOTRADA

230 V LED 2 W 3000 K 130 lm Ra 80 IP54

R10557 gris plata

€ 48 %

↑ 100
225x85



LED

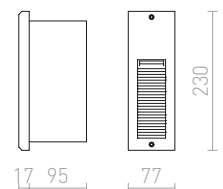



IP54

GAP

Lámpara de pared empotrable de aluminio pintado. Adecuada para el uso en interiores y exteriores. Instalar sólo hacia abajo.

GAP EMPOTRADA

230 V LED 3 W 3000 K 180 lm Ra 80 IP54

R10545 gris plata

€ 68 %

↑ 55
 ⚡ 190x45



LED

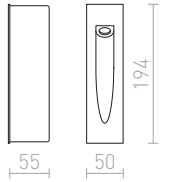

IP65

AKORD

Lámpara de pared para exteriores, con marco de acero inoxidable y cristal transparente. Dimensiones visibles del vidrio 11.8 / 11.5 cm.

AKORD EMPOTRADA AL MURO

230 V LED 3 W 3000 K 260 lm Ra 80 IP65

R10546 acero inoxidable

€ 88 %

↑ 65
 ⚡ 180x155



LED

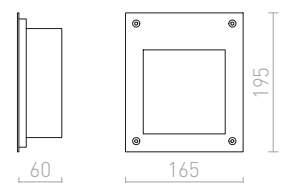



IP67



ORBU

Luminaria empotrada de metal para los exteriores.

ORBU R

230 V GU10 35 W IP67

R10555 acero inoxidable

€ 78

± 105

☉ Ø98



G11837

103

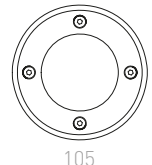
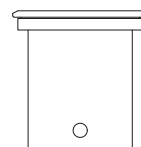
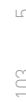

105

ORBU SQ 10 EMPOTRADO

230 V LED GU10 15 W IP67

R13439 acero inoxidable

€ 78

± 140

☉ Ø100



G11837

136

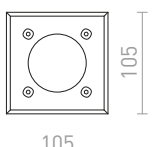
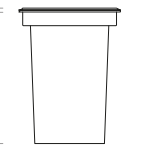

105

105



IP65



NAVY

Luminaria LED masiva para inserción en techos exteriores.

NAVY EMPOTRADA

230 V LED 15 W $\angle 36^\circ$ 2700 K 1100 lm Ra 80 IP65

R12661 blanco

€ 120 %

↑ 110
 ⚙️ Ø125

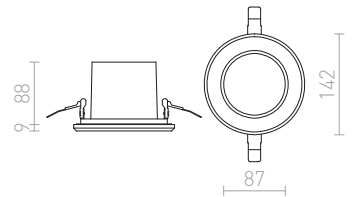
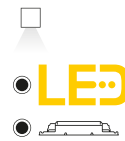

IP65



TERRA

Luminaria empotrada de exteriores con LED de alta potencia. Incluye un cable de 1 m.

TERRA EMPOTRADA

230 V LED 20 W $\angle 120^\circ$ 3000 K 1450 lm Ra 80 IP65

R10532 acero inoxidable

€ 198

↑ 100
 ⚙️ Ø190

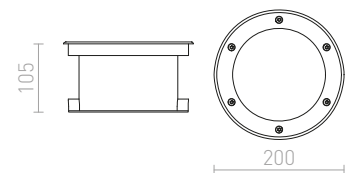
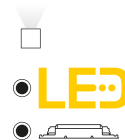

IP65



RIZZ

Luminaria empotrada de exteriores con CREE LED. Se suministra incluyendo el transformador.

RIZZ SQ 105

230 V LED 3 W $\angle 96^\circ$ 3000 K 128 lm Ra 80 IP65

R10436 acero inoxidable

€ 138

↑ 120
 ⚙️ Ø90

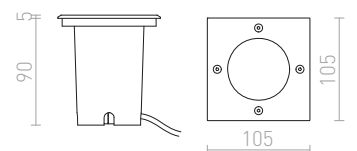
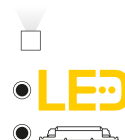





FUENTES DE LUZ

GREEN NEW!



NUEVAS CATEGORÍAS DE FUENTES DE LUZ LED

MEJOR EFICIENCIA ENERGÉTICA MAYOR CALIDAD

Sustituya fácilmente sus fuentes de luz clásicas o halógenas actuales por E14, E27, GU10, G9, G53 y otros casquillos.

MUY BAJO CONSUMO DE ENERGÍA

VIDA ÚTIL EXTREMADAMENTE LARGA

LUMINOSIDAD 100 % INSTANTÁNEA, SIN RETRASO CUANDO SE ENCIENDE

SIN UV Y RADIACIÓN INFRARROJA MUY BAJA EN EL ESPECTRO VISIBLE

EMISIONES DE CALOR MUY BAJAS EN COMPARACIÓN CON LOS PRODUCTOS DE REFERENCIA ESTÁNDAR

DISEÑO, PEQUEÑAS DIMENSIONES Y SALIDA DE LUMEN COMPARABLES A LAS LÁMPARAS INCANDESCENTES O HALÓGENAS

EXPLICACIÓN DE TÉRMINOS

RETROFIT sustitución directa de la lámpara clásica con casquillo E14 o E27.

No regulable / vida útil hasta 15,000 h / hasta 100,000 ciclos de conmutación / Ra = 80

PRO pista para uso profesional.

Regulable / vida útil hasta 45,000 h / hasta 1,000,000 de ciclos de conmutación / Ra > 90

ADV de alta calidad y flexibilidad para todas las aplicaciones con atenuación.

Regulable / vida útil hasta 40,000 h / hasta 100,000 ciclos de conmutación / Ra = 80

GLOWdim oscurece cambiando la intensidad de la luz, pero también el color – de blanco caliente a blanco muy caliente (2700 K-1800 K).

Regulable / vida útil hasta 25,000 h / hasta 100,000 ciclos de conmutación / Ra > 80

DIMM – puede ser atenuado con una variedad de reguladores comercialmente disponibles.

Bluetooth – control a través de Bluetooth usando la aplicación.

WIFI – control a través de WIFI usando la aplicación.

Ra (prestación de colores) – mide la tasa de autenticidad de color generada por cualquiera fuente de luz en comparación con la luz del día.

Cuanto más cercano el número es a 100, menor será la distorsión de color.



80 Ra

90 Ra

K (Kelvin) – describe la temperatura de color de la luz.

1800 K 2700 K 3000 K 4000 K 6500 K 12000 K 16000 K



blanco cálido 1800–2700 K

blanco neutro 3000–3500 K

blanco frío 4000–4500 K

luz día 5500–6500 K

Ángulos de haz

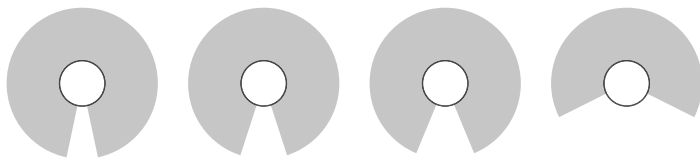

24°

36°

45°

120°

Todos los parámetros técnicos valen para la fuente de luz entera. Debido al complejo proceso de producción de los LED, los valores técnicos que se muestran son puramente estadísticos y no coinciden necesariamente con los parámetros técnicos actuales de cada producto, los cuales pueden variar.



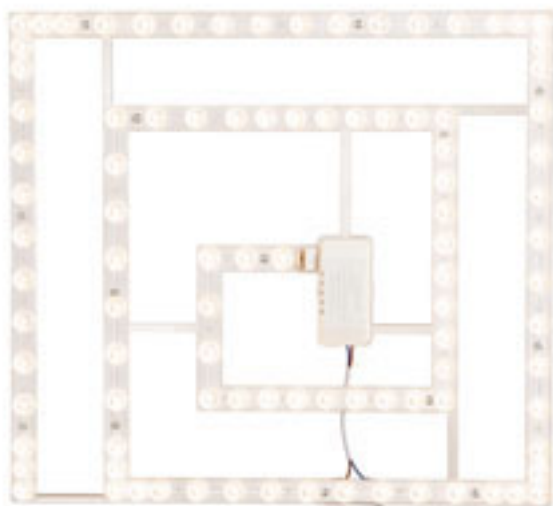

LED MODUL

Módulo LED de repuesto para un uso sencillo en lugar de las fuentes de luz existentes. El módulo LED se monta en las luminarias mediante soportes magnéticos integrados.

LED MODUL SQ 10

230 V LED 12 W 3000 K 900 lm Ra 80

G13546

€ 5.50

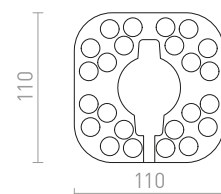
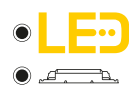

LED MODUL R 30

230 V LED 36 W 3000 K 2700 lm Ra 80

G13545

€ 14.50

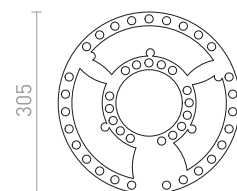

LED MODUL SQ 41

230 V LED 48 W 3000 K 3600 lm Ra 80

G13547

€ 22

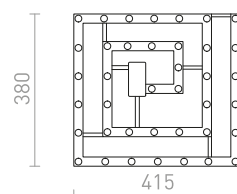



PARATHOM SMART

Bombilla LED Smart con casquillo E27, controlable mediante LEDVANCE SMART + Android 6.0 o Apple Homekit. Gestión de color RGBW. Temperatura de color de luz ajustable: 2700K a 6500K. Regulable mediante Bluetooth.

OSRAM SMART+ RGBW CLASSIC A

230 V E27 LED EQ 60 W 2700 K-6500 K 810 lm Ra 80

G13728 mate

€ 19

Ø60x120 mm



APPLICATION
ANDROID

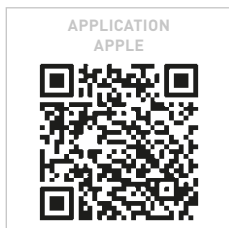

APPLICATION
APPLE



PARATHOM SMART

Bombilla LED Smart con casquillo E27 controlable mediante aplicación LEDVANCE SMART + Android 6.0 o Apple Homekit. Regulable mediante Bluetooth.

OSRAM SMART+ CLASSIC

230 V E27 LED EQ 60 W 2700 K 800 lm Ra 80

G13700 mate

€ 12

Ø60x120 mm



PARATHOM RGBW

Fuente de luz LED donde se puede utilizar tecnología RGB o iluminación en color blanco cálido. Fácil instalación sin el uso de una aplicación o un teléfono inteligente. Cambie de color, escenas de color, ajuste de la saturación del color o atenúe con solo tocar un botón. El paquete incluye un mando a distancia por infrarrojos.

OSRAM RGBW CLASSIC A

230 V E27 LED EQ 60 W 2700 K 806 lm Ra 80

G13579 mate

€ 16

Ø60x114 mm





PARATHOM RGBW

Fuente de luz LED donde se puede utilizar tecnología RGB o iluminación en color blanco cálido. Fácil instalación sin el uso de una aplicación o un teléfono inteligente. Cambie de color, escenas de color, ajuste de la saturación del color o atenúe con solo tocar un botón. El paquete incluye un mando a distancia por infrarrojos.

OSRAM RGBW PAR16

230 V GU10 LED EQ 25 W 2700 K 250 lm Ra 80

G13577 blanco

€ 15

Ø50x56 mm



PARATHOM RGBW

Fuente de luz LED donde se puede utilizar tecnología RGB o iluminación en color blanco cálido. Fácil instalación sin el uso de una aplicación o un teléfono inteligente. Cambie de color, escenas de color, ajuste de la saturación del color o atenúe con solo tocar un botón. El paquete incluye un mando a distancia por infrarrojos.

OSRAM RGBW ILUM

230 V E14 LED EQ 40 W 2700 K 470 lm Ra 80

G13578 mate

€ 13.50

Ø47x91 mm

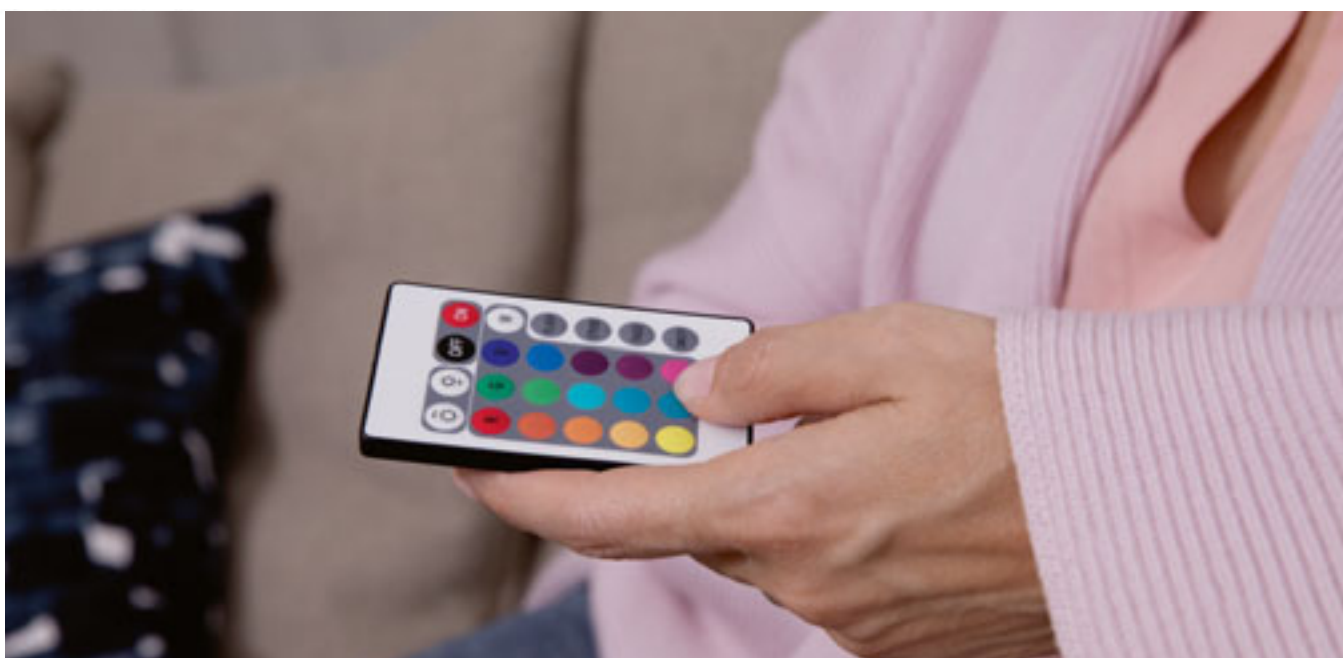



PARATHOM SMART

Fuente de luz LED Globe Smart WiFi con casquillo E27 regulable mediante: LEDVANCE SMART+ WiFi (versión Android 4.4 o iOS 9.0 o superior), Google Assistant o Amazon Alexa. Controlado a través de WiFi.

OSRAM SMART+ GLOBE 125 WIFI

230 V E27 LED EQ 60 W 2700 K 806 lm Ra 80

G13943 claro

€ 22

NEW

Ø124x168 mm



WIFI

OSRAM SMART+ GLOBE 125 WIFI

230 V E27 LED EQ 60 W 2700 K 806 lm Ra 80

G13944 ámbar

€ 25

NEW

Ø124x168 mm



WIFI

OSRAM SMART+ GLOBE 125 WIFI

230 V E27 LED EQ 60 W 2700 K 806 lm Ra 80

G13945 de color humo

€ 25

NEW

Ø124x168 mm



WIFI

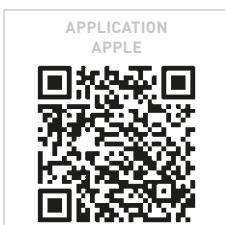
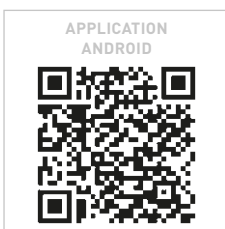

PARATHOM SMART

Bombilla LED Globe inteligente para enchufes E27 que se puede controlar mediante la aplicación WiFi LEDVANCE SMART+ (se requiere Android 4.4 / iOS 9.0 o superior), así como Google Assistant o Amazon Alexa. La funcionalidad RGBW te permitirá seleccionar colores o establecer una temperatura de color específica, de 2700K a 6500K. Utiliza WiFi para comunicarse.

OSRAM SMART+ GLOBE 95

230 V E27 LED EQ 100 W RGBW 1521 lm Ra 80

G13833 mate

€ 38

Ø95x142 mm



**OSRAM
VINTAGE GLOBE 125 DECO**



Ø125x168 mm
ámbar
230 V LED E27 EQ 40 W
2500 K 470 lm Ra 80
G13311

€ 25

**OSRAM
VINTAGE GLOBE 125 SPIRAL**



Ø125x178 mm
de color humo
230 V LED E27 EQ 15 W
1800 K 140 lm Ra 80
G13459

€ 24

**OSRAM
VINTAGE GLOBE 125 SPIRAL**



Ø125x178 mm
ámbar
230 V LED E27 EQ 25 W
2000 K 250 lm Ra 80
G13152

€ 17

**OSRAM
VINTAGE GLOBE 125 DIMM**



Ø125x173 mm
ámbar regulable
230 V LED E27 EQ 55 W
2400 K 650 lm Ra 80
G13023

€ 18.50

**OSRAM
VINTAGE BALLON DIMM**



Ø170x270 mm
claro regulable
230 V LED E27 EQ 30 W
2700 K 400 lm Ra 80
G13953 NEW

€ 88

**OSRAM
VINTAGE EDISON SPIRAL**



Ø64x140 mm
de color humo
230 V LED E27 EQ 25 W
1800 K 250 lm Ra 80
G13581

€ 24

**OSRAM
VINTAGE EDISON SPIRAL**



Ø64x140 mm
ámbar
230 V LED E27 EQ 25 W
2000 K 250 lm Ra 80
G13309

€ 14

**OSRAM
RETROFIT EDISON**



Ø64x143 mm
claro
230 V LED E27 EQ 40 W
2700 K 470 lm Ra 80
G13573

€ 11.50

**OSRAM
VINTAGE**



Ø75x156 mm
ámbar
230 V LED E27 EQ 40 W
2500 K 470 lm Ra 80
G13310

€ 24

**OSRAM
RETROFIT TUBE**



Ø25x80 mm
claro
230 V LED E14 EQ 40 W
2700 K 470 lm Ra 80
G13150

€ 9.20

**OSRAM
VINTAGE TUB**



Ø28.5x138 mm
ámbar
230 V LED E27 EQ 20 W
2400 K 200 lm Ra 80
G13021

€ 13

**OSRAM
VINTAGE TUB**



Ø28.5x204 mm
ámbar
230 V LED E27 EQ 35 W
2400 K 400 lm Ra 80
G13022

€ 17

**OSRAM
VINTAGE VELA**



Ø35x100 mm
ámbar
230 V LED E14 EQ 35 W
2400 K 410 lm Ra 80
G13308

€ 8.35

**OSRAM
TOP ILUM**



Ø45x78 mm
cromo
230 V LED E14 EQ 31 W
2700 K $\angle 320^\circ$ 380 lm Ra 80
G13013

€ 9

**OSRAM
TOP CLASSIC A**



Ø60x105 mm
cromo
230 V LED E27 EQ 50 W
2700 K 650 lm Ra 80
G13154

€ 11

**OSRAM
TOP CLASSIC A**



Ø60x105 mm
hoja dorada
230 V LED E27 EQ 50 W
2700 K 650 lm Ra 80
G13458

€ 7.80

**OSRAM
RETROFIT GLOBE 125**



Ø124x168 mm
claro
230 V LED E27 EQ 25 W
2700 K 250 lm Ra 80
G12244 € 9.80

**OSRAM
RETROFIT GLOBE 125**



Ø124x168 mm
claro
230 V LED E27 EQ 40 W
2700 K 470 lm Ra 80
G12245 € 11.50

**OSRAM
RETROFIT GLOBE 125**



Ø124x168 mm
claro
230 V LED E27 EQ 60 W
2700 K 806 lm Ra 80
G12246 € 14.50

**OSRAM
RETROFIT GLOBE 125**



Ø124x168 mm
mate
230 V LED E27 EQ 100 W
2700 K 1521 lm Ra 80
G13460 € 24

**OSRAM
RETROFIT GLOBE 95**



Ø95x138 mm
mate
230 V LED E27 EQ 60 W
2700 K 806 lm Ra 80
G13024 € 10.50

**OSRAM
RETROFIT GLOBE 95 DIMM**



Ø95x135 mm
vidrio opal regulable
230 V LED E27 EQ 75 W
2700 K 1055 lm Ra 80
G13462 € 15.50

**OSRAM
RETROFIT GLOBE 95 DIMM**



Ø95x135 mm
vidrio opal regulable
230 V LED E27 EQ 100 W
2700 K 1521 lm Ra 80
G13461 € 22

**OSRAM
ULTRA ECONOMY
210LM/W GLOBE 95**



Ø95x140 mm **A**
claro
230 V LED E27 EQ 60 W
3000 K 840 lm Ra 80
G13951 **NEW** € 24

**OSRAM
ULTRA ECONOMY
210LM/W GLOBE 95**



Ø95x140 mm **A**
mate
230 V LED E27 EQ 60 W
3000 K 840 lm Ra 80
G13952 **NEW** € 24

**LAMBRINA
230**



Ø230x80 mm
mate
230 V LED E27 36 W
3000 K 2200 lm Ra 80
G13518 **NEW** € 15.50

**OSRAM
ULTRA ECONOMY
210LM/W CLASSIC A**



Ø60x105 mm **A**
claro
230 V LED E27 EQ 60 W
3000 K 840 lm Ra 80
G13947 **NEW** € 22

**OSRAM
ULTRA ECONOMY
210LM/W CLASSIC A**



Ø60x105 mm **A**
claro
230 V LED E27 EQ 100 W
3000 K 1521 lm Ra 80
G13948 **NEW** € 28

**OSRAM
ULTRA ECONOMY
210LM/W CLASSIC A**



Ø60x105 mm **A**
mate
230 V LED E27 EQ 60 W
3000 K 840 lm Ra 80
G13949 **NEW** € 22

**OSRAM
ULTRA ECONOMY
210LM/W CLASSIC A**



Ø60x105 mm **A**
mate
230 V LED E27 EQ 100 W
3000 K 1521 lm Ra 80
G13950 **NEW** € 28

**OSRAM
RETROFIT VELA**



Ø35x100 mm
claro
230 V LED E14 EQ 40 W
2700 K 470 lm Ra 80
G11849

€ 5.35

**OSRAM
RETROFIT VELA**



Ø35x100 mm
claro
230 V LED E14 EQ 40 W
4000 K 470 lm Ra 80
G13455

€ 5.35

**OSRAM
RETROFIT VELA**



Ø35x100 mm
claro
230 V LED E14 EQ 60 W
2700 K 806 lm Ra 80
G13725

€ 8.25

**OSRAM
RETROFIT VELA**



Ø35x100 mm
mate
230 V LED E14 EQ 25 W
2700 K 250 lm Ra 80
G13946 NEW

€ 4.80

**OSRAM
RETROFIT VELA DIMM**



Ø35x97 mm
mate regulable
230 V LED E14 EQ 40 W
2700 K 470 lm Ra 80
G13151

€ 7.80

**OSRAM
RETROFIT VELA DIMM**



Ø35x100 mm
mate regulable
230 V LED E14 EQ 60 W
2700 K 806 lm Ra 80
G13454

€ 11.50

**OSRAM
RETROFIT ILUM DIMM**



Ø45x78 mm
mate regulable
230 V LED E14 EQ 25 W
2700 K 250 lm Ra 80
G13847 NEW

€ 7.80

**OSRAM
RETROFIT ILUM**



Ø45x78 mm
claro
230 V LED E14 EQ 40 W
2700 K 470 lm Ra 80
G12243

€ 5.80

**OSRAM
RETROFIT ILUM DIMM**



Ø45x78 mm
claro regulable
230 V LED E14 EQ 60 W
2700 K 806 lm Ra 80
G13572

€ 8.80

**OSRAM
RETROFIT ILUM**



Ø45x77 mm
mate
230 V LED E14 EQ 40 W
2700 K 470 lm Ra 80
G13098

€ 5.50

**OSRAM
RETROFIT MINI-BALL DIMM**



Ø45x78 mm
mate regulable
230 V LED E14 EQ 60 W
2700 K 806 lm Ra 80
G13453

€ 11.50

**OSRAM
RETROFIT ILUM DIMM**



Ø45x77 mm
claro regulable
230 V LED E27 EQ 40 W
2700 K 470 lm Ra 80
G13014

€ 8.25

**OSRAM
RETROFIT MINI-BALL**



Ø45x77 mm
claro
230 V LED E27 EQ 60 W
2700 K 806 lm Ra 80
G13307

€ 8.80

**OSRAM
RETROFIT ILUM DIMM**



Ø45x77 mm
mate regulable
230 V LED E27 EQ 25 W
2700 K 250 lm Ra 80
G13119

€ 7.80

**OSRAM
RETROFIT ILUM DIMM**



Ø45x77 mm
mate regulable
230 V LED E27 EQ 40 W
2700 K 470 lm Ra 80
G13015

€ 8.50

**OSRAM
RETROFIT CLASSIC A DIMM**



Ø60x105 mm
claro regulable
230 V LED E27 EQ 40 W
2700 K 470 lm Ra 80
G13110 € 7.35

**OSRAM
RETROFIT CLASSIC A DIMM**



Ø60x105 mm
claro regulable
230 V LED E27 EQ 60 W
2700 K 806 lm Ra 80
G13111 € 7.35

**OSRAM
RETROFIT CLASSIC A DIMM**



Ø60x105 mm
claro regulable
230 V LED E27 EQ 75 W
2700 K 1055 lm Ra 80
G13112 € 11

**OSRAM
RETROFIT CLASSIC A DIMM**



Ø60x105 mm
claro regulable
230 V LED E27 EQ 100 W
2700 K 1521 lm Ra 80
G13123 € 14.50

**OSRAM
RETROFIT CLASSIC A DIMM**



Ø60x105 mm
mate regulable
230 V LED E27 EQ 40 W
2700 K 470 lm Ra 80
G13099 € 8.35

**OSRAM
RETROFIT CLASSIC A DIMM**



Ø60x106 mm
mate regulable
230 V LED E27 EQ 60 W
2700 K 806 lm Ra 80
G13026 € 8.35

**OSRAM
RETROFIT CLASSIC A DIMM**



Ø60x105 mm
mate regulable
230 V LED E27 EQ 60 W
4000 K 806 lm Ra 80
G13027 € 8.35

**OSRAM
RETROFIT CLASSIC A DIMM**



Ø60x105 mm
mate regulable
230 V LED E27 EQ 75 W
2700 K 1055 lm Ra 80
G13028 € 12

**OSRAM
RETROFIT CLASSIC A DIMM**



Ø60x105 mm
mate regulable
230 V LED E27 EQ 75 W
4000 K 1055 lm Ra 80
G13477 € 12

**OSRAM
RETROFIT CLASSIC A**



Ø60x105 mm
mate
230 V LED E27 EQ 100 W
2700 K 1521 lm Ra 80
G13029 € 12

**OSRAM
RETROFIT CLASSIC A DIMM**



Ø60x105 mm
mate regulable
230 V LED E27 EQ 100 W
2700 K 1521 lm Ra 80
G13306 € 14.50

**OSRAM
RETROFIT CLASSIC A**



Ø70x118 mm
mate
230 V LED E27 EQ 150 W
2700 K 2452 lm Ra 80
G13457 € 24

**OSRAM
ADV CLASSIC A DIMM**



Ø67x143 mm
mate regulable
230 V LED E27 EQ 150 W
2700 K <200° 2452 lm Ra 80
G12237 € 24

**OSRAM
RETROFIT CLASSIC A**



Ø95x162 mm
mate
230 V LED E27 EQ 200 W
2700 K 3452 lm Ra 80
G13831 € 35

**OSRAM
RETROFIT CLASSIC A DIMM**



Ø90x184 mm
mate regulable
230 V LED E27 EQ 200 W
2700 K 3452 lm Ra 80
G13832 € 35

**LED E27
TUBE**



Ø50x100 mm
230 V LED E27 7,5 W
3000 K ∠180° 700 lm Ra 80
G12985 ➔ **€ 3.80**

**OSRAM
TUBE**



Ø36x116 mm
mate
230 V LED E27 EQ 75 W
2700 K 1050 lm Ra 80
G13155 **€ 7.80**

**OSRAM
PIN MICRO G4**



Ø10x30 mm
12 V LED G4 EQ 10 W
2700 K ∠300° 100 lm Ra 80
G13828 **€ 11**

**OSRAM
PIN G4**



Ø13x36 mm
12 V LED G4 EQ 20 W
2700 K ∠300° 200 lm Ra 80
G13034 **€ 7.35**

**OSRAM
PIN G4**



Ø14x40 mm
12 V LED G4 EQ 30 W
2700 K ∠320° 300 lm Ra 80
G13035 **€ 8.80**

**OSRAM
PIN G9**



Ø16x60 mm
vidrio transparente
230 V LED G9 EQ 30 W
2700 K ∠320° 300 lm Ra 80
G13478 ➔ **€ 11**

**OSRAM
PIN G9**



Ø15x46 mm
230 V LED G9 EQ 20 W
2700 K 200 lm Ra 80
G13715 **€ 6.80**

**OSRAM
PIN G9**



Ø15x47 mm
230 V LED G9 EQ 30 W
2700 K ∠300° 320 lm Ra 80
G13036 **€ 8.80**

**OSRAM
PIN G9 DIMM**



Ø16x52 mm
regulable
230 V LED G9 EQ 30 W
2700 K 320 lm Ra 80
G13829 **€ 17**

**OSRAM
PIN G9**



Ø19x52 mm
230 V LED G9 EQ 40 W
2700 K ∠300° 470 lm Ra 80
G13037 **€ 12**

**OSRAM
PIN G9**



Ø19x52 mm
230 V LED G9 EQ 40 W
4000 K ∠300° 470 lm Ra 80
G13038 **€ 12**

**OSRAM
PIN G9 DIMM**



Ø18x59 mm
regulable
230 V LED G9 EQ 40 W
2700 K 470 lm Ra 80
G13830 **€ 22**

**OSRAM
PIN G9**



Ø18x59 mm
230 V LED G9 EQ 50 W
2700 K ∠320° 600 lm Ra 80
G13464 **€ 17**

**OSRAM
SPECIAL SLIM**



Ø18x90 mm
claro
230 V LED B15d EQ 60 W
2700 K ∠320° 806 lm Ra 80

G13456 € 38

**OSRAM
SPECIAL SLIM DIMM**



Ø18x100 mm
claro regulable
230 V LED B15D EQ 75 W
2700 K 1055 lm Ra 80

G13574 € 48

**OSRAM
SLIM LINE 118MM**



Ø20x118 mm
claro
230 V LED R7S EQ 100 W
2700 K 1521 lm Ra 80

G13576 € 24

**OSRAM
LINE 118MM DIMM**



Ø28x118 mm
regulable
230 V LED R7S EQ 125 W
2700 K ∠300° 2000 lm Ra 80

G13044 € 38

**OSRAM
LINE 118MM DIMM**



Ø28x118 mm
claro regulable
230 V LED R7s EQ 150 W
2700 K 2452 lm Ra 80

G13468 € 58

**OSRAM
SLIM LINE 78MM**



Ø20x78 mm
claro
230 V LED R7S EQ 60 W
2700 K ∠300° 806 lm Ra 80

G13575 € 16.50

**OSRAM
LINE 78MM DIMM**

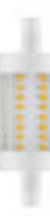

Ø29x78 mm
regulable
230 V LED R7S EQ 75 W
2700 K ∠300° 1055 lm Ra 80

G13043 € 18

**OSRAM
LINE 78MM DIMM**



Ø28x78 mm
claro regulable
230 V LED R7s EQ 100 W
2700 K 1521 lm Ra 80

G13467 € 32

**OSRAM
HALO PIN G9**



Ø14x43 mm
claro regulable
230 V G9 EQ 25 W
2700 K 235 lm Ra 100

G13122 € 5

**OSRAM
HALO PIN G9**



Ø14x43 mm
claro regulable
230 V G9 EQ 40 W
2700 K 460 lm Ra 100

G13045 € 5

**OSRAM
HALO LINE 78MM**



Ø12x78 mm
claro regulable
230 V R7S EQ 60 W
2900 K 750 lm Ra 100

G13047 € 9

**OSRAM
MR16 DIMM**



Ø50x44 mm
regulable
12 V LED GU5,3 EQ 35 W
3000 K ∠36° 345 lm Ra 90

G13960 NEW € 12

**OSRAM
PRO MR16 DIMM**



Ø51x46 mm
regulable
12 V LED GU5,3 EQ 20 W
3000 K ∠36° 230 lm Ra 97

G12234 € 11

**OSRAM
MR16 DIMM**



Ø50x44 mm
regulable
12 V LED GU5,3 EQ 50 W
3000 K ∠36° 621 lm Ra 90

G13705 € 17.50

**OSRAM
PAR16 DIMM**



Ø51x55 mm
regulable
230 V LED GU10 EQ 35 W
2700 K ∠36° 230 lm Ra 90

G13120 € 7.80

**OSRAM
ADV PAR16 DIMM**



Ø51x55 mm
regulable
230 V LED GU10 EQ 35 W
3000 K ∠36° 230 lm Ra 90

G11837 € 7.80

**OSRAM
ADV PAR16 DIMM**



Ø50x52 mm
regulable
230 V LED GU10 EQ 35 W
4000 K ∠36° 230 lm Ra 90

G12206 € 7.80

**OSRAM
PRO PAR16 DIMM**



Ø51x55 mm
regulable
230 V LED GU10 EQ 35 W
3000 K ∠36° 230 lm Ra 97

G11852 € 10.50

**OSRAM
ADV PAR16 DIMM**



Ø50x52 mm
regulable
230 V LED GU10 EQ 50 W
2700 K ∠36° 350 lm Ra 90

G11840 € 8.35

**OSRAM
ADV PAR16 DIMM**



Ø51x55 mm
regulable
230 V LED GU10 EQ 50 W
3000 K ∠36° 350 lm Ra 90

G11841 € 8.35

**OSRAM
ADV PAR16 DIMM**



Ø50x52 mm
regulable
230 V LED GU10 EQ 50 W
4000 K ∠36° 350 lm Ra 90

G12207 € 8.35

**OSRAM
PAR16**



Ø51x55 mm
regulable
230 V LED GU10 EQ 50 W
2700 K ∠120° 350 lm Ra 80

G12232 € 6

**OSRAM
ADV PAR16 DIMM**



Ø50x52 mm
regulable
230 V LED GU10 EQ 80 W
3000 K ∠36° 550 lm Ra 90

G12065 € 13

**OSRAM
PAR16 DIMM**



Ø51x54 mm
regulable
230 V LED GU10 EQ 80 W
4000 K ∠36° 575 lm Ra 90

G13041 € 13

**OSRAM
PAR16 DIMM**



Ø50x52 mm
regulable
230 V LED GU10 EQ 80 W
2700 K ∠120° 575 lm Ra 90

G13040 € 13

**OSRAM
PAR16 DIMM**



Ø50x52 mm
regulable
230 V LED GU10 EQ 100 W
3000 K ∠36° 750 lm Ra 80

G13706 € 19

**OSRAM
PAR16**



Ø50x53 mm
blanco
230 V LED GU10 EQ 35 W
2700 K ∠36° 230 lm Ra 80
G13465 € 4.35

**OSRAM
PAR16**



Ø50x53 mm
blanco
230 V LED GU10 EQ 50 W
2700 K ∠36° 350 lm Ra 80
G13466 € 6

**ALFA
69**



Ø69x70 mm
gris plata/cromo
230 V LED GU10 6 W
3000 K ∠24° 300 lm Ra 80
G13406 € 11

**ALFA
69**



Ø69x70 mm
gris plata/cromo
230 V LED GU10 6 W
4000 K ∠24° 300 lm Ra 80
G13407 € 11

**OSRAM
PRO AR111 DIMM**



Ø111x62 mm
regulable
12 V LED G53 EQ 50 W
3000 K ∠24° 450 lm Ra 90
G13722 € 48

**OSRAM
PRO AR111 DIMM**



Ø111x62 mm
regulable
12 V LED G53 EQ 100 W
2700 K ∠24° 950 lm Ra 90
G13723 € 58

**OSRAM
PRO AR111 DIMM**



Ø107x55 mm
regulable
12 V LED G53 EQ 75 W
4000 K ∠24° 800 lm Ra 97
G13724 € 48

**OSRAM
PRO AR111 DIMM**



Ø111x62 mm
regulable
12 V LED G53 EQ 50 W
3000 K ∠40° 450 lm Ra 97
G13655 € 48

**OSRAM
PRO AR111 DIMM**



Ø111x62 mm
regulable
12 V LED G53 EQ 75 W
3000 K ∠40° 800 lm Ra 97
G13656 € 48

**OSRAM
PRO AR111 DIMM**



Ø111x62 mm
regulable
12 V LED G53 EQ 75 W
3000 K ∠24° 800 lm Ra 97
G13657 € 48

**LED
ES111**



Ø111x70 mm
blanco
230 V LED GU10 12 W
3000 K ∠45° 1000 lm Ra 80
G12723 € 12

**LED
ES111**



Ø111x70 mm
gris
230 V LED GU10 12 W
3000 K ∠45° 1000 lm Ra 80
G12724 € 12

**LED
ES111**



Ø111x70 mm
blanco
230 V LED GU10 12 W
4000 K ∠45° 1000 lm Ra 80
G12725 € 12

**LED
ES111**



Ø111x70 mm
gris
230 V LED GU10 12 W
4000 K ∠45° 1000 lm Ra 80
G12726 € 12

**OSRAM
R50 DIMM**



Ø50x85 mm
regulable
230 V LED E14 EQ 60 W
2700 K ∠36° 345 lm Ra 90

G13147 € 11.50

**OSRAM
R63 DIMM**



Ø63x105 mm
regulable
230 V LED E27 EQ 60 W
2700 K ∠36° 345 lm Ra 90

G13148 € 14

**OSRAM
R80 DIMM**



Ø80x115 mm
regulable
230 V LED E27 EQ 100 W
2700 K ∠36° 670 lm Ra 80

G13149 € 18

**OSRAM
PAR20 DIMM**



Ø65x85 mm
regulable
230 V LED E27 EQ 50 W
2700 K ∠36° 345 lm Ra 90

G13020 € 12

**OSRAM
ADV PAR30 DIMM**



Ø95x93 mm
regulable
230 V LED E27 EQ 75 W
2700 K ∠36° 633 lm Ra 90

G12067 € 22

**OSRAM
ADV PAR38 DIMM**



Ø120x132 mm
regulable
230 V LED E27 EQ 120 W
2700 K ∠30° 1035 lm Ra 80

G12068 € 32



**OSRAM
PAR16 GLOWDIM**



Ø50x54 mm
regulable
230 LED GU10 EQ 50 W
2700 K ∠36° 350 lm Ra 80

G13185 € 11.50

**OSRAM
ADV VELA GLOWDIM**



Ø38x105 mm
mate regulable
230 V LED E14 EQ 40 W
2700 K 470 lm Ra 80

G12209 % € 8.50

**OSRAM LEDINESTRA
1P 30 DIMM**

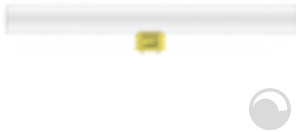

Ø300 mm
mate regulable
230 V LED S14d EQ 27 W
2700 K 275 lm Ra 80
G11860 € 38

**OSRAM LEDINESTRA
1P 50 DIMM**



Ø500 mm
mate regulable
230 V LED S14d EQ 40 W
2700 K 470 lm Ra 80
G11862 € 48

**OSRAM LEDINESTRA
2P 30 DIMM**

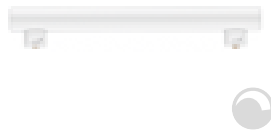

Ø300 mm
mate regulable
230 V LED S14s EQ 27 W
2700 K 275 lm Ra 80
G11859 € 38

**OSRAM LEDINESTRA
2P 50 DIMM**

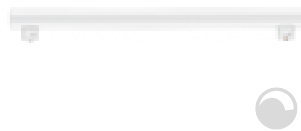

Ø500 mm
mate regulable
230 V LED S14s EQ 40 W
2700 K 470 lm Ra 80
G11861 € 48

**OSRAM LEDINESTRA
2P 100 DIMM**



Ø29x1000 mm
mate regulable
230 V LED S14s EQ 75 W
2700 K 1055 lm Ra 80
G12251 € 88

**OSRAM
DULUX L**



Ø413 mm
mate
230 V LED 2G11 EQ 36 W
3000 K 2070 lm Ra 80
G13469 € 48

**OSRAM
DULUX L**



Ø413 mm
mate
230 V LED 2G11 EQ 36 W
4000 K 2300 lm Ra 80
G13470 € 48

**OSRAM
STAR**



Ø75x28 mm
230 V LED GX53 EQ 40 W
2700 K ∠120° 470 lm Ra 80
G13032 € 11.50

**OSRAM
STAR**



Ø75x28 mm
230 V LED GX53 EQ 40 W
4000 K ∠120° 470 lm Ra 80
G13033 € 11.50

**PUC
FUENTE DE LUZ**



Ø74x27 mm
230 V LED GX53 7 W
3000 K ∠105° 560 lm Ra 80
G12340 € 8





INTERRUPTORES Y ACCESORIOS



DRIVER

Driver LED 350mA.

DRIVER LED 1-3W

350 mA 4,2W

G13124

€ 5.80

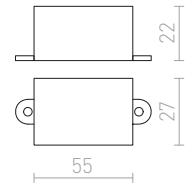

DRIVER

LED transformador 700mA.

DRIVER LED 1x3W

700 mA 3 W

G13125

€ 5.80

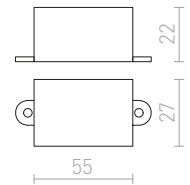

DRIVER

Driver LED 350mA.

DRIVER LED 3-8W

350 mA 8,5 W

G13008

€ 28

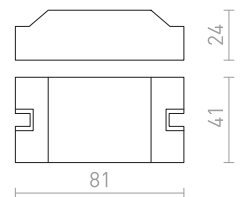

DRIVER

Driver LED 350mA.

DRIVER LED 7-15W

350 mA 16 W

G13806

€ 8.50

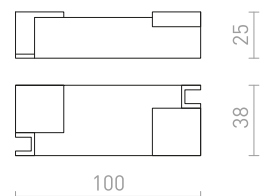



TRAF0 12V

Transformador 12 AC.

TRAF0 20-70W 12V AC DIMM

12 V 70 W

G13002

€ 19

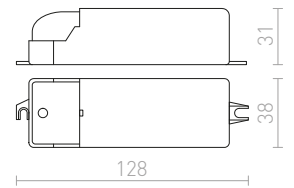

regulable



TRAF0 12V

Transformador 12 AC.

TRAF0 35-105W 12V AC DIMM

12 V 105 W

G13003

€ 22

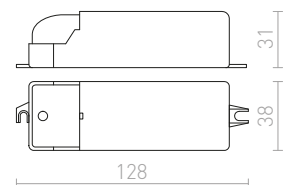

regulable



TRAF0 12V

Transformador 12 AC.

TRAF0 50-150W 12V AC DIMM

12 V 150 W

G13004

€ 58

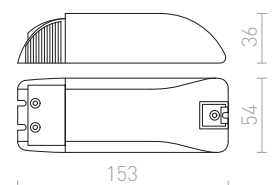

regulable



DRIVER

Transformador LED 500mA 9-18W. Atenuación TRIAC.

DRIVER LED 9-18W DIMM

500 mA max 18 W

G13840

€ 48

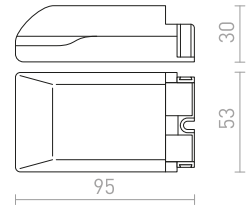

regulable



DRIVER

LED driver 700mA 3x3W. Atenuación TRIAC.

DRIVER LED 3x3W DIMM

700 mA 10 W

G13009

€ 35

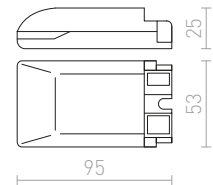

regulable



IP67

TRAFO 12V=

Transformador 12V DC.

TRAFO 0-20W

230 V/12 V= 20 W IP67

G14018

€ 22

NEW

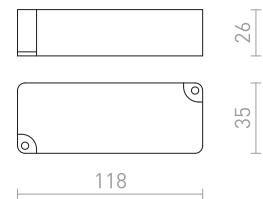

TRAFO 24V=

Transformador 24 DC.

TRAFO 0,5-20W

24= 20 W

G13006

€ 48

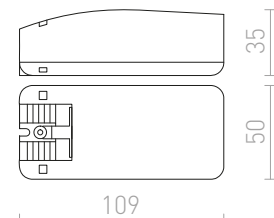



IP44

IP-BOX

Bloque de terminales con protección contra ambientes húmedos. Adecuado para cable 3x1.5.

IP-BOX

IP44

G12582 blanco

€ 1.80

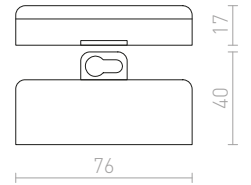

IP67

IP-BOX

Embrague de cable adecuado para entornos al aire libre. Adecuado para cable 3x1.5.

IP-BOX

230 V IP67

G12984

€ 5.20

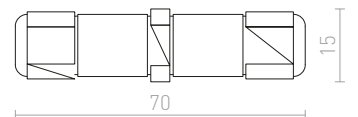

IP65

IP-BOX

Cajas de conexión adecuadas para entornos al aire libre. Adecuado para cable 3x1.5.

IP-BOX

230 V IP65

G12983

€ 3.80

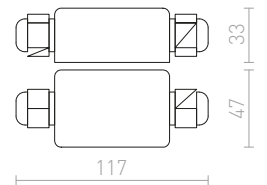

IP68

IP-BOX

Empalme de cable para uso exterior. Apto para cables de 2x1,5. Se suministra con 4 arandelas y 2 tapones.

IP-BOX IP68

IP68

G13846 negro

€ 12

NEW

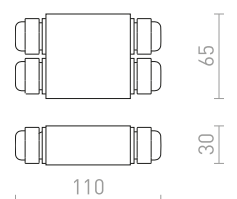



SENSOR

Adaptador de rosca E27 con sensor de movimiento integrado.

SENSOR E27

230 V E27 60 W ∠360°

G12752

€ 11 %

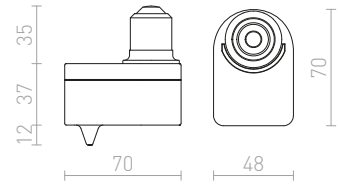

SENSOR

Sensor de movimiento para montaje en techo o pared.

SENSOR DE TECHO

230 V max 2000 W ∠360°

G12754

€ 12.50

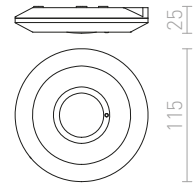

SENSOR

Sensor de movimiento para montaje en luminarias adecuadas.

SENSOR PARA MONTAR EN UNA LUMINARIA

230 V max 1200 W ∠360°

G12755 blanco

€ 10.50

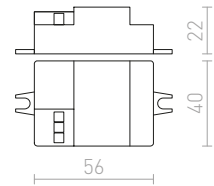

IP65



IP-BOX

Cubierta duradera en ambiente húmedo para proteger el sensor de movimiento G12755.

IP-BOX PARA SENSOR G12755

IP65

G12756

€ 4.80 %

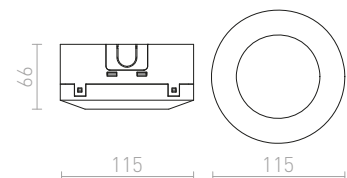



SENSOR

Sensor de movimiento con sensor externo en el cable. El sensor externo sólo se utiliza para detectar (determinar) la intensidad de la luz para el correcto funcionamiento del sensor.

SENSOR AL FALSO TECHO

max 1200 W $\angle 360^\circ$

G12753 blanco

€ 13.50

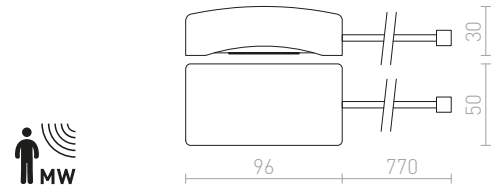

IP65

SENSOR

Sensor de movimiento para montaje en luminarias.

SENSOR PARA MONTAR EN LÁMPARAS EXTERIORES

230 V max 500 W $\angle 180^\circ$ IP65

G12757 blanco

€ 6 %

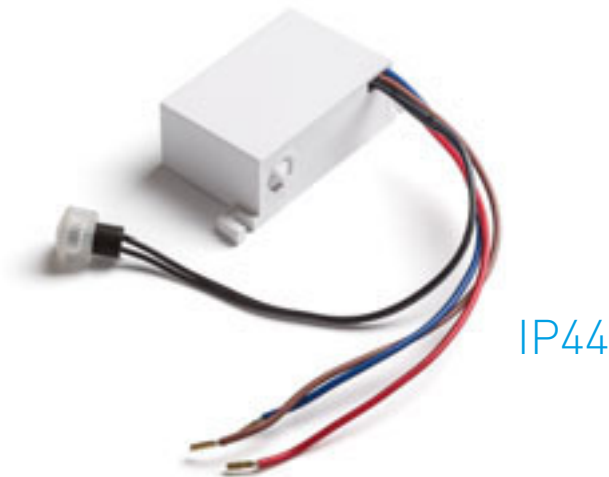
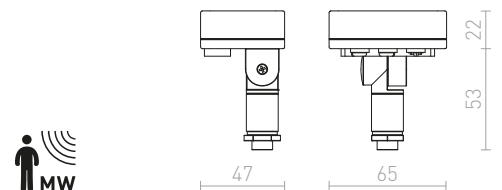

IP44

DARK SENSOR

Interruptor crepuscular para conmutación automática con sensor externo.

DARK SENSOR 5-50 LUX INCORPORADO

230 V IP44

G12758 blanco

€ 5 %

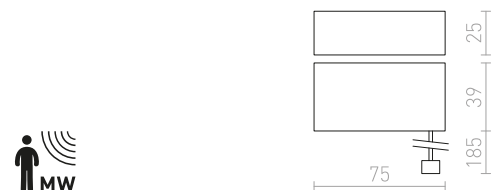

IP44

DARK SENSOR

Interruptor crepuscular para conmutación automática para uso en exteriores.

DARK SENSOR 2-100 LUX MONTADO EN SUPERFICIE

230 V IP44

G12759 negro

€ 7.80

G13528 blanco

€ 7.80

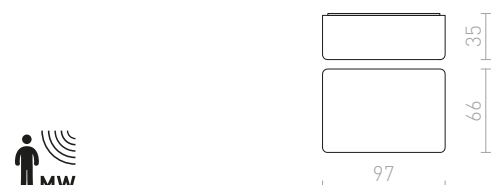

1F carril	532-533	BABYMOON colgando en pie	630-631	CADENZA para carriles monofásicos	540-541
A		BAHIA para carril trifásico	504-505	CADENZA para carriles trifásicos	506-507
ABAX en pie	638-639	BALEA para gabinetes	190-191	CALLUM de pared	210-211
ACASA empotrada	446-447	BAROQUE de pared	310-311	CAMARGUE de pared	660-661
ACUA empotrada	400-401	BARRY de techo	100-101	CAMINO lámpara de mesa	338-339
ADAGIO de pared	196-197	BEACON muro	630-631	CAMINO lámpara de mesa con pantalla	338-339
AGATE de pared	250-251	BEAT pantalla para colgante	572-573	CAMINO colgante	16-17
AGATE de techo	138-139	BEAU MONDE colgante	34-35	CANTO Pantalla interior decorativa	132-133
AGNETA para carril monofásico colgante	554-555	BEEBA para carril monofásico	544-545	CANTO Luz de techo sin pantalla interior	132-133
AGNETA para carril trifásico colgante	522-523	BEEBA para carril trifásico	510-511	CARISSIMA colgante	70-71
AGNETA pared o techo	310-311	BEJA de pared	684-685	CARRE de pared	240-241
AGNETA colgante	64-65	BELENOS para carriles monofásicos	540-541	CASSABLANCA colgante	76-77
AIM en cuello de ganso	304-305	BELENOS para carril monofásico colgante	552-553	CASSAMBA de pared	186-187
AINO colgante	30-31	BELENOS para carriles trifásicos	508-509	CASSIE de pared	316-317
AKORD empotrada al muro	722-723	BELENOS para carril trifásico colgante	526-527	CASUAL pantalla	590-591
ALFA	740-741	BELENOS aplique de techo	126-127	CELEIA pared o techo	310-311
ALGOT de mesa	338-339	BELENOS colgante	62-63	CELEIA de mesa	342-343
ALLEGRO DIMM techo	154-155	BELI empotrado	396-397	CHIC de pared	228-229
ALVIS base lámpara de pie	612-613	BELLA empotrada	392-393	CHICAGO de pared	666-667
ALVIS base lámpara de mesa	612-613	BELLINI para carril monofásico colgante	548-549	CHLOE de pared	252-253
ALVIS pantalla de mesa	576-577	BELLINI para sistema trifásico	516-517	CHOIX de pared	692-693
ALVIS/AMBITUS en pie	352-353	BELLINI colgante	42-43	CHOUPETTE de pared ajustable	278-279
ALVIS/AMBITUS de mesa	322-323	BEND base de arco de pared	608-609	CHOUPETTE para vías de un circuito	552-553
ALVIS/ILUSION en pie	352-353	BENITA de pared	228-229	CHOUPETTE para vías de tres circuitos	520-521
ALVIS/RIDICK en pie	352-353	BERIT de techo	140-141	CHOUPETTE colgante	26-27
ALVIS/RON de mesa	324-325	BERMUDA empotrada	398-399	CINDY colgante	32-33
AMADEUS de pared	282-283	BIANCA empotrada	416-417	CIRA techo	98-99
AMARO empotrada	474-475	BIARITZ de pared	242-243	CLAIRE de pared	658-659
AMBER de pared	262-263	BJORK empotrada	448-449	CLANK colgante	22-23
AMBITUS en pie	352-353	BLONDIE para carril monofásico	554-555	CLUB empotrada	470-471
AMBITUS pantalla lámpara de pie	576-577	BLONDIE para carriles trifásicos	522-523	CLYDE muro	634-635
AMBITUS base lámpara de pie	612-613	BLONDIE colgante	66-67	CLYDE poste	634-635
AMBITUS base lámpara de mesa	612-613	BLUESTAR en estaca	698-699	COCO colgante	20-21
AMBITUS pantalla de mesa	576-577	BOB en cuello de ganso	306-307	COIMBRA empotrada	428-429
AMBITUS/ALVIS de mesa	322-323	BOBO de pared	264-265	COLES aplique de techo	120-121
AMENITY de pared	194-195	BOBO en pie	642-643	COLES de techo inclinable	120-121
AMICI colgante de silicona	26-27	BODIE aplique de pared	228-229	COLIN techo	116-117
AMIGA DIMM	394-395	BOGARD tubo para lámpara colgante	62-63	COMODO de pared	672-673
ANDANTE de pared	668-669	BOGARD de pared	286-287	CONDU de techo	126-127
ANIKA de mesa	342-343	BOGARD de techo	126-127	CONFETTI colgante	20-21
ANTE de pared	226-227	BOGARD colgante	62-63	CONNOR para carril monofásico	542-543
APRIORI	398-399	BOLLY montadas en superficie	206-207	CONNOR para carril trifásico	506-507
AQILA de pared	262-263	BOLLY techo	106-107	CONNOR de techo	130-131
ARANA techo	104-105	BOLLY colgante	36-37	CONNOR pantalla de pie	574-575
ARAQ de pared	278-279	BONDY empotrada	438-439	CONNOR pantalla de mesa	574-575
ARAQ para carril monofásico colgante	548-549	BONNIE muro	634-635	CONNOR pantalla	574-575
ARAQ para carril trifásico colgante	520-521	BONNIE poste	634-635	COPA para carriles monofásicos	546-547
ARAQ colgante	64-65	BONO montadas en superficie	114-115	COPA para carriles trifásicos	516-517
ASHLEY de pared	224-225	BORA en estaca	700-701	COPA colgante	64-65
ASPRO pantalla	572-573	BORA de pared	696-697	CORAZON	204-205
ASTERI colgante	76-77	BOSANNA en pie	632-633	CORDOBA en estaca	698-699
ASTERIA empotrada	470-471	BOSANOVA en pie	632-633	COROA colgante	44-45
ASTON para carril trifásico	522-523	BOULOGNE en pie	354-355	CORONA colgante	42-43
ASTON colgante	66-67	BOURDON de pared	682-683	CORTINA soporte de pie	616-617
ASTOR	402-403	BRAN empotrada	404-405	CORTINA soporte de mesa	616-617
ASTRAL colgante	32-33	BROADWAY de mesa	326-327	CORTINA/JAKARANDA en pie	362-363
ASTROMET colgante	32-33	BROADWAY colgante ajustable	52-53	COSMO en estaca	700-701
ATHI de pared	238-239	BROADWAY colgante con brazo	54-55	COWLEY aplique de pared	230-231
ATLANTA montadas en superficie	238-239	BRUXEL de pared	238-239	COZY de mesa	346-347
AWE de techo	100-101	BUCKY para carril trifásico	524-525	CRESCENDO de pared	200-201
AZRIA colgante	42-43	BUCKY colgante	24-25	CRESCENT de pared	232-233
B		BUGSY de pared	316-317		
BABADES para carriles monofásicos	552-553	BUGSY de pie	370-371	D	
BABADES para carriles trifásicos	526-527	BUGSY de mesa	344-345	DADA empotrada	450-451
BABADES colgante	70-71	BURTON para sistema trifásico	528-529	DADOS colgante	50-51
BABU colgante	40-41	BURTON colgante	16-17	DAFFY de pared	242-243
		C		DAG empotrada	418-419
		CABOX de pared	674-675	DAISY pantalla para colgante	572-573
				DAN empotrada	426-427

DANDY empotrada	418-419	ETESIAN en pie	360-361	H	
DANTE suelo	358-359	EUTRAC carril trifásico	490-491	HAREN montado en superficie	278-279
DARIO anillo decorativo	128-129	EZRA colgante	22-23	HAY de pared	234-235
DARIO para carril monofásico	542-543			HEAVY DUTY reflector exterior	702-703
DARIO para carril trifásico	506-507	F		HEIDI de mesa	338-339
DARIO techo	128-129	FABIO conjunto de suspensión	602-603	HEIDI colgante	14-15
DARK SENSOR montado en superficie	750-751	FACA empotrada	722-723	HEX montura de suspensión	598-599
DARK SENSOR incorporado	750-751	FADO de pared	280-281	HIDE de pared	668-669
DEJAVU empotrada	480-481	FADO en pie	370-371	HUDSON de pared	218-219
DELISA pantalla	580-581	FADO de mesa	346-347	HUE DIMM de techo	152-153
DELTA de pared	666-667	FANCY colgante	28-29	HUE DIMM empotrada	454-455
DELTA montadas en superficie	664-665	FANGIO para carril trifásico	504-505	HUE de techo	150-151
DESMOND muro	250-251	FAO de pared	204-205	HUE empotrada	452-453
DESTY para carriles monofásicos	554-555	FAROS exterior	704-705		
DESTY para carriles trifásicos	526-527	FAX para carril trifásico	512-513	I	
DESTY colgante	64-65	FIATLUX colgante	28-29	ICAR para carriles monofásicos	552-553
DEZA cuadrado	112-113	FIT cable PPM	618-619	ICAR colgante	26-27
DIDO de pared	248-249	FIT cable textil PPM	618-619	ILLUSION pantalla	578-579
DIFFUSER	588-589	FIT cable textil	618-619	ILUSIA colgante	16-17
DIFFUSER PRISM	582-583	FIZZ inclinable	440-441	IMPERIA de pared	196-197
DINGO inclinable	424-425	FLAP de pared	308-309	IMPERISO	184-185
DINGO fijo	422-423	FLATLINE para carril trifásico	496-497	INCA	404-405
DINGO empotrada	426-427	FLORIDA colgante	14-15	INEZ	392-393
DINO inclinable	426-427	FLORIO	202-203	INTRO	476-477
DIREZZA en estaca	698-699	FOCUS DIMM para carril monofásico	536-537	IP-BOX	748-749
DIREZZA de pared	694-695	FOCUS DIMM para carril trifásico	498-499	IP-BOX para sensor G12755	750-751
DIXIE de pared	688-689	FOND de pared	238-239	IPSO	428-429
DOUBLE pantalla	586-587	FORZA para carriles monofásicos	540-541	IPSO fijo	428-429
DRIVER	746-747	FORZA para carriles trifásicos	508-509	IRIA empotrada	464-465
DRIVER DIMM	748-749	FOX reflector exterior	694-695	ISLA empotrada	404-405
DUBLIN montado en superficie	208-209	FRISCO de pared	304-305	ITAKA de pared	710-711
DUDE de pared	290-291	FRISCO de mesa	344-345		
DUDE para carril monofásico	540-541	FRUTTI para sistema trifásico	528-529	J	
DUDE para carril trifásico	508-509	FRUTTI colgante	18-19	JACK de pared	234-235
DUDE pared o techo	290-291			JACK para carril trifásico	528-529
DUGME	292-293	G		JACK techo	118-119
DURANT de pared	662-663	GAN de pared	230-231	JACK colgante	16-17
		GAP empotrada	722-723	JAKARANDA pantalla	578-579
E		GARBO de mesa	342-343	JAMAICA colgante	24-25
EDIKA en pie	360-361	GARDETTE en pie	356-357	JAMES DIMM de techo	140-141
EDIKA de mesa	330-331	GARDETTE de mesa	324-325	JERSEY de pared	218-219
EIGHT para carril trifásico colgante	518-519	GARDIEN pie	642-643	JOLI de pared	310-311
EIGHT de techo	108-109	GARNISH para sistema trifásico	518-519	JOLI mesa	344-345
EIGHT colgante	46-47	GARNISH colgante	46-47	JULIETTA para carril monofásico	550-551
EILEEN techo	110-111	GARNISH de pared	636-637	JULIETTA para carril trifásico	516-517
EKE de pared	304-305	GARY en estaca	700-701	JULIETTA colgante	40-41
EL PASO lámpara de mesa	324-325	GAVIN de pared	670-671		
ELECTRA	430-431	GAYA	136-137	K	
ELIA de pared	632-633	GERI de pared	680-681	KANE de pared	678-679
ELIA en pie	632-633	GIFT colgante	48-49	KAY empotrada	416-417
ELICA exterior	466-467	GIGI de pared	680-681	KAYA de pared	308-309
ELICA empotrada	466-467	GINA de pared	228-229	KEIG techo	650-651
ELISA para carriles monofásicos	554-555	GINA techo	116-117	KEITH base de mesa con USB	614-615
ELISA para carril trifásico	530-531	GINO de pared	662-663	KEITH/ALVIS de mesa con USB	326-327
ELISA montura de suspensión	600-601	GIULIA para carril monofásico	550-551	KEITH/AMBITUS de mesa con USB	328-329
ELISEO de pared	284-285	GIULIA para carril trifásico	520-521	KEITH/DELISA de mesa con USB	326-327
ELISEO pared o techo	300-301	GIULIA colgante	58-59	KEITH/RON de mesa con USB	334-335
ELLA colgante	14-15	GLAMOUR colgante	28-29	KELLY DIMM de pared	298-299
ENCOMBRE colgante	20-21	GLANS de pared	212-213	KELLY DIMM semi-empotrada	296-297
ENKI	138-139	GLOSSY	302-303	KELLY DIMM de techo	130-131
ENZO conjunto de suspensión	602-603	GLOSSY en cuello de ganso	302-303	KELLY DIMM empotrada	432-433
EQUA	398-399	GLOSSY colgante	72-73	KELLY de pared	296-297
ESICA de techo	108-109	GORDIQ empotrada	478-479	KELLY para carril trifásico	512-513
ESME colgante	18-19	GORRA de techo	100-101	KENNY anillo decorativo	288-289
ESPLANADE en pie	358-359	GRANADA	434-435	KENNY montadas en superficie	288-289
ESPLANADE de mesa	330-331	GRANDE techo	96-97	KENNY de techo	288-289
ESPLANADE colgante	26-27	GRANITA de pared	228-229	KICK empotrada	472-473
ESSEX de pared	248-249	GUN en estaca	698-699	KIM techo	110-111
ESTRA colgante	48-49			KOMBIX montura de suspensión	596-597

KORSO de pared	248-249	MARGO colgante	66-67	NIZZA pantalla	576-577
KUBI	686-687	MARINA de pared	198-199	NYC soporte de pie	616-617
KUBIS de pared	234-235	MARIO	246-247	NYC soporte de mesa	616-617
L					
LALA para carriles monofásicos	542-543	MARVEL de techo	142-143	NYC/CONNY en pie	364-365
LALO colgante	30-31	MARVEL inclinable	142-143	NYC/CONNY de mesa	332-333
LAMBRINA	734-735	MARVEL de techo	142-143	NYC/ILUSION en pie	360-361
LARISA DIMM de techo	148-149	MAUI base para mesa	614-615	NYC/RON en pie	362-363
LARISA de techo	146-147	MAUI/ALVIS de mesa	326-327	NYC/RON de mesa	334-335
LARISA colgante	76-77	MAUI/AMBITUS de mesa	328-329	NYC/TEMPO en pie	366-367
LAURA lámpara de mesa	330-331	MAUI/CONNY de mesa	332-333	NYC/TEMPO de mesa	336-337
LEA de pared	252-253	MAVRO DIMM para carril monofásico	538-539	O	
LED	740-741	MAVRO DIMM para carril trifásico	502-503	ONYX de pared	248-249
LED E27	738-739	MAVRO DIMM colgante	60-61	OPTIMUS para carriles monofásicos	536-537
LED MODUL	728-729	MAVRO para carril monofásico	538-539	OPTIMUS para carriles trifásicos	500-501
LED PROFILE montadas en superficie 1m	562-563	MAVRO para carril monofásico colgante	552-553	OPTIMUS techo	312-313
LED PROFILE empotrada 1m	564-565	MAVRO para carril trifásico	502-503	OPTIMUS colgante	62-63
LED STRIP	560-561	MAVRO colgante	60-61	ORBU	724-725
LED STRIP driver	556-557	MAYO de techo direccional	134-135	ORBU empotrado	724-725
LED STRIP Tira LED 5m	558-559	MEA de techo cilíndrico	134-135	ORIN techo	112-113
LED STRIP fuente de alimentación	560-561	MEGALOS cuerpo	86-87	ORIT de pared	314-315
LED STRIP alimentación	560-561	MELISA de techo	170-171	OSRAM	732-733
LED STRIP conexión principal	560-561	MEMPHIS empotrada al muro	466-467	OSRAM 78mm	738-739
LED STRIP conexión	560-561	MENSA de techo	154-155	OSRAM DIMM	734-735
LED STRIP		MENSA colgante	78-79	OSRAM GLOWdim	742-743
atenuador con mando a distancia	560-561	MERANO techo	114-115	OSRAM ilum	730-731
LED STRIP controlador Wi-fi 5en1	556-557	MERGO empotrada	392-393	OSRAM mini-ball DIMM	736-737
LEDA empotrada	444-445	MERIDO de techo	112-113	OSRAM SPIRAL	734-735
LEROY	404-405	MERIKO fijo	446-447	OSRAM vela	736-737
LESA de pared	692-693	MERINGUE techo	106-107	OSRAM vela DIMM	736-737
LEVIA de pared	192-193	MERYLYN colgante	72-73	OSRAM vela GLOWdim	742-743
LEVIA juego de manijas para gabinetes	192-193	MEZZO DIMM de techo	74-75	OSRAM LEDINESTRA DIMM	742-743
LEVITA colgante ajustable	52-53	MEZZO set colgantes	74-75	OTIS de techo	122-123
LINN de pared	206-207	MIA empotrada	426-427	OWEN DIMM empotrado	394-395
LINN montadas en superficie	206-207	MICO de pared	244-245	P	
LISA conjunto de suspensión	602-603	MICO de pared	244-245	PALEA	188-189
LIZ colgante	50-51	MIDZACK de pared	242-243	PANON de pared	184-185
LIZARD empotrada	438-439	MIG muro	280-281	PARAGNA de pared	188-189
LIZZI de pared	644-645	MILANO de techo	136-137	PARIS para gabinetes	190-191
LIZZI de techo	644-645	MIRANDA de pared	200-201	PASADENA	436-437
LOLA techo	110-111	MIRO empotrada	442-443	PASADENA empotrada	436-437
LOLLIPOP para carril trifásico	502-503	MIZZI	646-647	PEKKO de pared	248-249
LOPE de pared	214-215	MIZZI de pared	674-675	PER empotrada	474-475
LOPE pantalla	592-593	MIZZI NEW de pared	646-647	PERISA de pared	194-195
LOPE colgante	30-31	MOCCA de techo	134-135	PERTH pared con foco LED	220-221
LORCA en estaca	700-701	MOIRE de pared	244-245	PERTH suelo	366-367
LOYD de techo	56-57	MOMA inclinable	134-135	PERTH mesa	328-329
LUISA de pared	186-187	MOMA de techo	134-135	PESANTE empotrada	462-463
LULU en pie	364-365	MONACO de mesa	336-337	PESANTE colgante	82-83
LULU de mesa	332-333	MONE direccional	440-441	PIA de pared	680-681
LUNA para carril monofásico	546-547	MONET aplique de pared	186-187	PIPER de pared	682-683
LUNA para carril trifásico	514-515	MONETA DIMM colgante	76-77	PIXIE	
LUNA colgante	36-37	MONROE para carril trifásico	524-525	en cuello de ganso para carril trifásico	512-513
LUNEA colgante triplex	38-39	MONROE colgante	68-69	PIXIE inclinable	128-129
LUTON base de soporte	614-615	MONTANA de pared	226-227	PIXIE para carril trifásico	512-513
LUTON/ILUSION en pie	354-355	MONTANA mesa	340-341	PIXIE de techo	128-129
LUTON/RIDICK en pie	354-355	MORA de pared	692-693	PLAZA de pared con luz LED	222-223
LUTON/RON en pie	356-357	MORE base de techo colgante	594-595	PLAZA en pie	366-367
M					
MADISON de pared	224-225	MURO empotrada	446-447	PLAZA de mesa	336-337
MADISON de techo	54-55	N			
MAJESTIC	398-399	NANCY colgante	18-19	POINT de pared	306-307
MANTOVA de techo	136-137	NAUTIC lámpara de pie	356-357	POLLOCK colgante	24-25
MARA de techo	124-125	NAVY empotrada	390-391	PONDER de pared o de pie	640-641
MARCO empotrada	470-471	NAXOS de pared	246-247	PONDER en pie	640-641
MAREA de pared	188-189	NEMAN de pared	252-253	PONTA reflector con sensor	696-697
MARENGA empotrada	406-407	NICK de pared	250-251	POSTE base de techo	604-605
N					
		NIZZA de mesa	340-341	PRAGMA en pie	368-369
		NIZZA soporte de mesa	610-611	PRIOR LED de pared	254-255
				PRODIGI para carril trifásico	504-505

PUC fuente de luz	742-743	SIENA de pared	284-285	TRIP de pared	248-249
PULIRE para carriles monofásicos	548-549	SIENA para carriles monofásicos	542-543	TRIX conjunto de suspensión	604-605
PULIRE colgante	44-45	SINTRA para carril trifásico	524-525	TUBA de pared	242-243
PURINA para carril monofásico	544-545	SINTRA colgante	68-69	TUBA de techo	132-133
PURINA para carril trifásico	510-511	SIV montado en la superficie	682-683	TUTTI para sistema trifásico	528-529
		SPLENDER montadas en superficie	168-169	TUTTI colgante	18-19
		SPLENDER empotrada	460-461	TWIST muro	254-255
		SNAZZY	128-129		
Q		SOBER empotrada	442-443	U	
QUADRA de techo	650-651	SOCORRO montadas en superficie	168-169	UKKO de pared	250-251
QUO empotrada	420-421	SOCORRO empotrada	460-461		
		SOLARIS pared o techo	122-123	V	
R		SOLO base de techo	604-605	VADE	132-133
RADICAL colgante	14-15	SONET de pared	638-639	VADIS de pared	636-637
RAGG empotrada	476-477	SONET en pie	638-639	VADIS en pie	636-637
RALLONG base de techo	594-595	SONNY de techo	652-653	VALE muro	308-309
RALLONG base colgante	594-595	SONYA	652-653	VALTO de pared	206-207
RARA colgante	22-23	SORANO muro	644-645	VALTO montadas en superficie	206-207
RASQ empotrada al muro	476-477	SORANO techo	644-645	VARIA suelo	368-369
REDO inclinable	316-317	SPECTACLE montadas en superficie	114-115	VECINO de pared	670-671
REEM de pared	246-247	SPIDER conjunto de suspensión	606-607	VENICE techo	104-105
RENO de pared	708-709	SPIDER soporte	606-607	VERIA de pared	666-667
RENO montadas en superficie	708-709	SPLASH empotrada	402-403	VERITA de pared	230-231
REWA fijo	442-443	SPRAY empotrada	434-435	VERO empotrada	400-401
RIDICK pantalla	578-579	STIG de pared	282-283	VERSA de pared	306-307
RIGA de techo	130-131	STIG en pie	368-369	VERSA de pared con pantalla	220-221
RIGA colgante	60-61	STIG colgante	60-61	VERSINA con pantalla	220-221
RINA muro	642-643	STRUCTURAL montadas en superficie	174-175	VESCO colgante	24-25
RINA en pie	642-643	STRUCTURAL empotrada	462-463	VIENNA montadas en superficie	238-239
RINO marco decorativo	390-391	STRUCTURAL colgante	80-81	VIP direccional	442-443
RINO empotrada sin cubierta	390-391	SWAY baño	184-185	VIPER	346-347
RIO empotrada	468-469	SWING sobre cuadro	256-257	VIRGO de pared	672-673
RITZY en pie	358-359			VOLCA techo	120-121
RITZY de mesa	340-341	T		VOLTERA de pared	284-285
RIZZ	724-725	TACO de techo	122-123		
RODGE de techo	650-651	TAINA con pantalla	222-223	W	
ROLO aplique de pared	236-237	TAMPA tapas de extremo 2 piezas	202-203	WATERBOY	390-391
RON de pared	214-215	TAMPA de pared sin tapa final	202-203	WIM de pared	236-237
RON pantalla	582-583	TAPA de pared	246-247	WISH Dimmable para carriles monofásicos	538-539
ROSITA de pared	302-303	TAPIO aplique de pared	280-281	WISH Dimmable para carriles trifásicos	500-501
ROSITA en pie	368-369	TAPIO lámpara de mesa	346-347	WOODY soporte de mesa	610-611
ROSITA de mesa	344-345	TARIS montadas en superficie	654-655	WOOP de pared	660-661
ROSS reflector exterior	702-703	TECH fijo	444-445		
ROSTAM pared con USB	278-279	TELO de pared	674-675	X	
ROZA de pared	246-247	TEMPO pantalla	588-589	XYLO de pared	672-673
		TERRA empotrada	724-725		
S		TESS empotrada	474-475	Y	
SAMMY exterior	110-111	THALIA de pared	282-283	YOLO sobre espejo	190-191
SAMPO muro	660-661	TIARA de pared	222-223		
SANSSOUCI para carril trifásico	518-519	TICO de pared	262-263	Z	
SANSSOUCI colgante	46-47	TIM empotrada	444-445	ZACK	684-685
SARA techo	102-103	TIRAS de pared	658-659	ZALA colgante	22-23
SASSARI techo	102-103	TITO DIMM montado en la pared	240-241	ZANE de pared	690-691
SAVOY para gabinetes	190-191	TITO de pared	240-241	ZARA techo	102-103
SCOTT de techo	654-655	TOLEDO	394-395	ZAZA de pared	680-681
SEGNO empotrada	464-465	TOMBA colgante	46-47	ZIZI empotrada	432-433
SELENA muro	216-217	TOPIC inclinable	442-443	ZUMA DIMM para carril trifásico	500-501
SELMA de pared	682-683	TOPTOP	704-705	ZUMBA lámpara de mesa	334-335
SEMPRE de techo con sensor	172-173	TOPTOP suelo	704-705	ZURI empotrada	446-447
SEMPRE de techo	170-171	TORINO de pared	252-253		
SENSOR	750-751	TRAFO	748-749		
SENSOR al falso techo	750-751	TRAFO DIMM	746-747		
SENSOR para montar en una luminaria	750-751	TRAX para carril trifásico	502-503		
SENSOR		TREEZA en pie	640-641		
para montar en lámparas exteriores	750-751	TRICA aplique de pared	294-295		
SENSOR de techo	750-751	TRICA para carril monofásico	544-545		
SENZA techo	648-649	TRICA para carril trifásico	510-511		
SHARM empotrada	386-387	TRIDENT cuerpo	84-85		
SHARP de pared	218-219	TRIDENT conjunto colgante 2 piezas	84-85		
SHOW de pared	306-307				
SID de pared	232-233				

G11837	740-741	G13119	736-737	G13944	732-733	R10437	660-661	R11296	170-171		492-493
G11840	740-741	G13120	740-741	G13945	732-733	R10438	660-661	R11297	170-171	R11352	490-491
G11841	740-741	G13122	738-739	G13946	736-737	R10439	660-661	R11299	160-161		492-493
G11849	736-737	G13123	736-737	G13947	734-735	R10441	640-641	R11300	490-491	R11353	490-491
G11852	740-741	G13124	746-747	G13948	734-735	R10444	426-427		492-493		492-493
G11859	742-743	G13125	746-747	G13949	734-735	R10445	234-235	R11301	490-491	R11354	490-491
G11860	742-743	G13147	742-743	G13950	734-735	R10446	236-237		492-493		492-493
G11861	742-743	G13148	742-743	G13951	734-735	R10448	234-235	R11302	490-491	R11355	490-491
G11862	742-743	G13149	742-743	G13952	734-735	R10451	232-233		492-493		492-493
G11867	584-585	G13150	734-735	G13953	734-735	R10454	120-121	R11303	490-491	R11356	490-491
	586-587	G13151	736-737	G13960	740-741	R10455	234-235		492-493		492-493
G11868	582-583	G13152	734-735	G14018	748-749	R10465	236-237	R11304	490-491	R11357	494-495
	586-587	G13154	734-735	R10119	140-141	R10478	38-39		492-493	R11358	490-491
G11869	582-583	G13155	738-739	R10120	140-141	R10479	38-39	R11305	490-491		492-493
G11870	588-589	G13185	742-743	R10122	142-143	R10491	204-205		492-493	R11359	492-493
G11871	588-589	G13306	736-737	R10123	142-143	R10492	108-109	R11306	494-495		494-495
G12065	740-741	G13307	736-737	R10124	134-135	R10493	46-47	R11307	490-491	R11360	490-491
G12067	742-743	G13308	734-735	R10129	244-245	R10500	100-101		492-493		492-493
G12068	742-743	G13309	734-735	R10132	244-245	R10501	46-47	R11308	490-491	R11361	490-491
G12206	740-741	G13310	734-735		690-691	R10509	46-47		492-493		492-493
G12207	740-741	G13311	734-735	R10133	244-245	R10510	48-49	R11309	490-491	R11362	490-491
G12209	742-743	G13406	740-741		740-741	R10511	46-47		492-493		492-493
G12232	740-741	G13407	740-741	R10148	440-441	R10513	32-33	R11310	494-495	R11365	214-215
G12234	740-741	G13453	736-737	R10166	112-113	R10515	66-67	R11311	490-491	R11368	214-215
G12237	736-737	G13454	736-737	R10170	244-245	R10516	34-35		492-493	R11370	574-575
G12243	736-737	G13455	736-737		690-691	R10517	34-35	R11312	490-491	R11371	574-575
G12244	734-735	G13456	738-739	R10171	142-143	R10518	34-35		492-493	R11372	574-575
G12245	734-735	G13457	736-737		316-317	R10519	344-345	R11313	490-491	R11377	214-215
G12246	734-735	G13458	734-735	R10173	316-317	R10520	370-371		492-493	R11381	214-215
G12251	742-743	G13459	734-735	R10178	262-263	R10521	316-317	R11314	490-491	R11383	214-215
G12299	584-585	G13460	734-735	R10204	440-441	R10522	76-77		492-493	R11461	586-587
	586-587	G13461	734-735	R10212	134-135	R10527	700-701	R11315	490-491	R11462	582-583
G12300	582-583	G13462	734-735	R10217	440-441	R10530	698-699		492-493	R11463	582-583
	586-587	G13464	738-739	R10218	440-441	R10532	724-725	R11316	490-491	R11464	214-215
G12340	742-743	G13465	740-741	R10219	446-447	R10536	24-25		492-493	R11465	584-585
G12366	560-561	G13466	740-741	R10251	618-619	R10538	306-307	R11317	490-491	R11466	572-573
G12367	560-561	G13467	738-739	R10252	618-619	R10539	30-31		492-493	R11467	572-573
G12368	560-561	G13468	738-739	R10253	618-619	R10540	30-31	R11318	490-491	R11468	574-575
G12369	560-561	G13469	742-743	R10254	618-619	R10541	304-305		492-493	R11469	574-575
G12370	560-561	G13470	742-743	R10262	194-195	R10542	302-303	R11319	490-491	R11471	590-591
G12371	560-561	G13477	736-737	R10263	194-195	R10543	302-303		492-493	R11472	590-591
G12372	560-561	G13478	738-739	R10264	194-195	R10545	722-723	R11320	490-491	R11473	592-593
G12373	560-561	G13518	734-735	R10265	194-195	R10546	722-723		492-493	R11474	592-593
G12374	560-561	G13528	750-751	R10266	232-233	R10547	636-637	R11321	490-491	R11475	588-589
G12375	560-561	G13545	728-729	R10269	424-425	R10548	636-637	R11321	492-493	R11476	588-589
G12377	560-561	G13546	728-729	R10270	424-425	R10552	654-655	R11322	490-491	R11477	586-587
G12378	560-561	G13547	728-729	R10271	422-423	R10553	646-647		492-493	R11478	586-587
G12582	748-749	G13572	736-737	R10272	426-427	R10554	674-675	R11323	490-491	R11479	582-583
G12723	740-741	G13573	734-735	R10304	416-417	R10555	724-725	R11323	492-493	R11480	582-583
G12724	740-741	G13574	738-739	R10326	140-141	R10557	722-723	R11324	490-491	R11481	584-585
G12725	740-741	G13575	738-739	R10351	670-671	R10558	470-471		492-493	R11482	572-573
G12726	740-741	G13576	738-739	R10352	688-689		714-715	R11325	490-491	R11483	572-573
G12752	750-751	G13577	730-731	R10353	688-689	R10565	394-395		492-493	R11484	590-591
G12753	750-751	G13578	730-731	R10354	688-689	R10566	394-395	R11326	490-491	R11485	590-591
G12754	750-751	G13579	730-731	R10355	688-689	R10572	392-393		492-493	R11486	592-593
G12755	750-751	G13581	734-735	R10356	688-689	R10574	402-403	R11327	490-491	R11487	592-593
G12756	750-751	G13655	740-741	R10361	652-653	R10576	100-101		492-493	R11488	588-589
G12757	750-751	G13656	740-741	R10362	652-653	R10578	66-67	R11328	490-491	R11489	588-589
G12758	750-751	G13657	740-741	R10363	652-653	R10580	220-221		492-493	R11490	582-583
G12759	750-751	G13670	84-85	R10364	692-693		776-777	R11329	490-491	R11491	582-583
G12983	748-749		174-175	R10365	692-693	R10581	76-77		492-493	R11492	214-215
G12984	748-749	G13671	84-85	R10366	692-693	R10582	160-161	R11330	490-491	R11493	584-585
G12985	738-739		174-175	R10367	640-641	R10584	78-79		492-493	R11494	572-573
G13002	746-747	G13672	84-85	R10368	640-641	R10586	392-393	R11331	490-491	R11495	572-573
G13003	746-747	G13700	730-731	R10372	630-631	R10587	392-393		492-493	R11496	574-575
G13004	746-747	G13705	740-741	R10374	134-135	R10588	190-191	R11332	490-491	R11497	574-575
G13006	748-749	G13706	740-741	R10379	710-711	R10591	316-317		492-493	R11498	574-575
G13008	746-747	G13715	738-739	R10380	640-641	R10598	476-477	R11333	490-491	R11500	590-591
G13009	748-749	G13722	740-741	R10382	652-653	R10602	306-307		492-493	R11501	590-591
G13013	734-735	G13723	740-741	R10383	652-653	R10604	302-303	R11334	490-491	R11502	592-593
G13014	736-737	G13724	740-741	R10384	674-675	R10605	30-31		492-493	R11503	592-593
G13015	736-737	G13725	736-737	R10385	650-651	R10612	188-189	R11335	490-491	R11504	214-215
G13020	742-743	G13728	730-731	R10386	650-651	R10613	188-189		492-493	R11505	588-589
G13021	734-735	G13749	86-87	R10387	662-663	R10614	188-189	R11336	490-491	R11506	588-589
G13022	734-735	G13750	86-87	R10388	694-695	R10615	604-605		492-493	R11507	586-587
G13023	734-735	G13751	86-87	R10395	400-401	R10616	602-603	R11337	490-491	R11508	586-587
G13024	734-735	G13798	558-559	R10395/12	400-401	R10617	602-603		492-493	R11509	214-215
G13026	736-737	G13799	558-559	R10398	680-681	R10618	602-603	R11338	490-491	R11510	584-585
G13027	736-737	G13800	556-557	R10399	680-681	R10620	26-27		492-493	R11511	592-593
G13028	736-737	G13801	556-557	R10400	248-249	R10622	602-603	R11339	490-491	R11512	214-215
G13029	736-737		558-559	R10401	246-247	R10623	602-603		492-493	R11513	588-589
G13032	742-743	G13802	556-557	R10402	444-445	R10624	602-603	R11340	490-491	R11514	588-589
G13033	742-743		558-559	R10404	444-445	R10625	602-603		492-493	R11515	586-587
G13034	738-739	G13803	556-557	R10407	400-401	R10626	76-77	R11341	494-495	R11516	586-587
G13035	738-739		558-559	R10418	416-417	R10639	466-467	R11342	494-495	R11517	582-583
G13036	738-739	G13804	556-557	R10419	416-417		716-717	R11343	494-495	R11518	582-583
G13037	738-739		558-559	R10420	442-443	R10640	512-513	R11344	494-495	R11519	214-215
G13038	738-739	G13806	746-747	R10421	442-443	R10641	512-513	R11345	494-495	R11520	584-585
G13040	740-741	G13820	556-557	R10427	698-699	R10644	512-513	R11346	490-491	R11522	214-215
G13041	740-741	G13828	738-739	R10428	112-113	R10645	512-513		492-493	R11523	588-589
G13043	738-739	G13829	738-739	R10428	648-649	R11169	666-667	R11347	490-491	R11524	588-589
G13044	738-739	G13830	738-739	R10429	112-113	R11170	638-639		492-493	R11535	586-587
G13045	738-739	G13831	736-737	R10429	648-649	R11171	638-639	R11348	490-491	R11541	592-593
G13047	738-739	G13832	736-737	R10430	11						

R11549	584-585		R11753	670-671	R11909	598-599	R12046	428-429	R12267	532-533	R12365	230-231
R11550	592-593			694-695	R11910	598-599	R12047	134-135		534-535	R12379	338-339
R11551	588-589			702-703	R11911	598-599	R12048	100-101	R12268	532-533	R12380	14-15
R11552	588-589	R11754		702-703	R11912	598-599	R12050	430-431		534-535	R12381	20-21
R11553	586-587	R11755		702-703	R11913	598-599	R12052	430-431	R12269	532-533	R12382	20-21
R11554	586-587			704-705	R11914	598-599	R12053	430-431		534-535	R12383	20-21
R11555	582-583	R11756		46-47	R11915	598-599	R12054	32-33	R12270	532-533	R12384	20-21
R11556	582-583	R11758		306-307	R11916	598-599	R12055	42-43		534-535	R12388	580-581
R11557	214-215	R11759		346-347	R11917	598-599	R12056	42-43	R12271	532-533	R12389	580-581
R11558	584-585	R11761		32-33	R11918	598-599	R12057	66-67		534-535	R12392	578-579
R11559	592-593	R11765		70-71	R11919	598-599	R12059	504-505	R12272	532-533	R12393	578-579
R11560	214-215	R11766		70-71	R11920	598-599	R12060	504-505		534-535	R12394	66-67
R11561	588-589	R11768		512-513	R11922	598-599	R12062	462-463	R12273	532-533	R12395	66-67
R11562	588-589	R11769		512-513	R11923	598-599	R12063	162-163		532-533	R12396	68-69
R11563	586-587	R11770		128-129	R11924	598-599	R12064	174-175	R12274	532-533	R12397	68-69
R11564	586-587	R11771		128-129	R11925	598-599	R12072	490-491		534-535	R12398	190-191
R11565	582-583	R11772		128-129	R11926	598-599		492-493	R12275	532-533	R12399	190-191
R11566	582-583			314-315	R11927	598-599	R12073	490-491		534-535	R12400	190-191
R11567	214-215	R11773		128-129	R11929	598-599		492-493	R12276	532-533	R12401	192-193
R11568	584-585			314-315	R11930	598-599	R12074	490-491		534-535	R12402	192-193
R11569	592-593	R11774		594-595	R11931	598-599		492-493	R12277	532-533	R12403	192-193
R11570	214-215	R11775		594-595	R11932	598-599	R12076	292-293		534-535	R12404	192-193
R11573	582-583	R11776		594-595	R11933	598-599	R12077	292-293	R12278	532-533	R12405	192-193
R11574	582-583	R11777		594-595	R11934	598-599	R12078	292-293		534-535	R12406	192-193
R11575	214-215	R11778		596-597	R11935	598-599	R12081	70-71	R12279	532-533	R12407	200-201
R11576	584-585	R11779		596-597	R11936	598-599	R12082	70-71		534-535	R12409	200-201
R11577	572-573	R11780		596-597	R11937	598-599	R12083	70-71	R12280	532-533	R12412	502-503
R11578	572-573	R11781		596-597	R11938	598-599	R12084	70-71		534-535	R12413	502-503
R11579	574-575	R11782		596-597	R11939	598-599	R12085	64-65	R12281	532-533	R12416	14-15
R11580	574-575	R11783		596-597	R11940	598-599	R12086	64-65		534-535	R12418	26-27
R11581	574-575	R11784		596-597	R11941	598-599	R12091	254-255	R12282	532-533	R12420	632-633
R11582	590-591	R11785		596-597	R11942	598-599	R12092	254-255		534-535	R12421	632-633
R11583	590-591	R11786		596-597	R11943	598-599	R12094	518-519	R12283	532-533	R12434	170-171
R11584	582-583	R11787		596-597	R11944	598-599	R12095	518-519		534-535	R12439	170-171
R11585	582-583	R11788		596-597	R11945	598-599	R12100	522-523	R12284	532-533	R12440	172-173
R11586	214-215	R11789		596-597	R11946	672-673	R12101	524-525		534-535	R12441	172-173
R11587	584-585	R11791		610-611	R11947	642-643	R12102	524-525	R12285	532-533	R12442	172-173
R11588	572-573	R11795		594-595	R11948	702-703	R12103	528-529		534-535	R12443	172-173
R11589	572-573	R11796		594-595	R11949	708-709	R12106	530-531	R12286	532-533	R12446	72-73
R11590	574-575	R11797		594-595	R11950	708-709	R12107	530-531		534-535	R12447	72-73
R11591	574-575	R11798		594-595	R11951	708-709	R12108	530-531	R12287	532-533	R12448	130-131
R11592	574-575	R11799		604-605	R11953	708-709	R12109	530-531		534-535	R12449	130-131
R11593	590-591	R11800		574-575	R11954	708-709	R12110	530-531	R12288	532-533	R12450	130-131
R11594	590-591	R11802		584-585	R11957	118-119	R12111	530-531		534-535	R12451	130-131
R11597	574-575	R11803		584-585	R11959	228-229	R12112	530-531	R12289	532-533	R12452	130-131
R11599	586-587	R11804		584-585	R11960	234-235	R12113	530-531		534-535	R12453	130-131
R11600	586-587	R11805		584-585	R11963	704-705	R12114	530-531	R12290	532-533	R12454	130-131
R11607	582-583	R11806		584-585	R11964	674-675	R12115	154-155		534-535	R12455	130-131
R11608	582-583	R11809		584-585	R11967	114-115	R12120	160-161	R12291	532-533	R12458	60-61
R11611	592-593	R11810		584-585		654-655	R12121	160-161		534-535	R12459	60-61
R11616	592-593	R11811		584-585	R11968	114-115	R12186	460-461	R12292	532-533	R12461	280-281
R11634	592-593	R11812		590-591		654-655	R12187	460-461		534-535	R12462	346-347
R11639	592-593	R11813		590-591	R11973	336-337	R12196	100-101	R12293	532-533		370-371
R11676	16-17	R11814		590-591	R11976	218-219	R12197	100-101		534-535	R12464	332-333
R11678	48-49	R11815		590-591	R11978	54-55	R12198	108-109	R12294	532-533	R12465	332-333
R11679	48-49	R11816		590-591	R11982	222-223	R12199	108-109		534-535	R12466	364-365
R11680	116-117	R11817		590-591	R11983	336-337	R12201	100-101	R12295	532-533	R12467	364-365
R11682	390-391	R11819		590-591	R11984	366-367	R12202	100-101		534-535	R12470	360-361
R11683	390-391	R11820		590-591	R11986	326-327	R12214	618-619	R12296	532-533	R12471	122-123
R11684	390-391	R11822		590-591	R11989	52-53	R12216	618-619		534-535	R12473	280-281
R11685	390-391	R11823		64-65	R11990	616-617	R12217	196-197	R12297	532-533	R12474	346-347
R11686	390-391	R11824		64-65	R11991	616-617	R12218	196-197		534-535	R12475	370-371
R11687	72-73	R11872		600-601	R11992	614-615	R12219	196-197	R12298	532-533	R12476	282-283
R11688	72-73	R11873		600-601	R11993	198-199	R12220	200-201		534-535	R12477	52-53
R11689	72-73	R11874		600-601	R11996	198-199	R12222	618-619		510-511	R12478	52-53
R11690	72-73	R11875		600-601	R11998	198-199	R12223	618-619	R12305	510-511	R12479	54-55
R11691	72-73	R11876		600-601	R12006	510-511	R12224	618-619	R12306	510-511	R12480	224-225
R11692	72-73	R11877		600-601	R12007	510-511	R12225	618-619	R12307	510-511	R12481	218-219
R11694	502-503	R11878		600-601	R12009	444-445	R12226	618-619	R12308	544-545	R12482	224-225
R11698	68-69	R11879		600-601	R12010	680-681	R12227	618-619	R12310	544-545	R12483	26-27
R11699	68-69	R11880		600-601	R12012	692-693	R12228	618-619	R12312	510-511	R12484	330-331
R11700	68-69	R11881		600-601	R12013	474-475	R12229	618-619	R12313	510-511	R12485	358-359
R11701	68-69	R11882		600-601	R12013	716-717	R12230	618-619	R12314	544-545	R12486	340-341
R11706	32-33	R11883		600-601	R12014	474-475	R12254	532-533	R12316	544-545	R12487	358-359
R11707	68-69	R11884		600-601		716-717		534-535	R12317	510-511	R12488	324-325
R11715	38-39	R11885		600-601	R12015	474-475	R12255	532-533	R12318	510-511	R12489	356-357
R11724	512-513	R11886		600-601		716-717		534-535	R12319	510-511	R12493	62-63
R11725	390-391	R11887		600-601	R12018	666-667	R12256	532-533	R12320	544-545	R12494	62-63
R11726	390-391	R11888		600-601	R12021	686-687		534-535	R12321	544-545	R12495	62-63
R11727	390-391	R11889		600-601	R12022	684-685	R12257	532-533	R12322	544-545	R12496	62-63
R11728	390-391	R11890		600-601	R12024	470-471		534-535	R12332	296-297	R12497	126-127
R11729	390-391	R11891		600-601	R12024	714-715	R12258	532-533	R12333	296-297		312-313
R11730	390-391	R11892		600-601	R12025	700-701		534-535	R12334	296-297	R12498	126-127
R11731	442-443	R11893		600-601	R12027	684-685	R12259	532-533	R12335	296-297		312-313
R11732	446-447	R11894		600-601	R12028	686-687		534-535	R12336	296-297	R12499	126-127
R11733	402-403	R11895		600-601	R12029	470-471	R12260	532-533	R12337	296-297		312-313
R11734	402-403	R11896		600-601	R12029	714-715		534-535	R12338	512-513	R12500	126-127
R11735	402-403	R11897		600-601	R12030	470-471	R12261	532-533	R12339	512-513		312-313
R11736	402-403	R11898		600-601	R12030	714-715		534-535	R12350	468-469	R12502	286-287
R11738	442-443	R11899		600-601	R12033	314-315	R12262	532-533	R12354	116-117	R12503	286-287
R11740	390-391	R11900		600-601	R12033	694-695						

R12515	642-643		R12615	712-713	R12743	246-247	R12888	450-451	R13067	458-459	R13243	386-387
R12516	134-135			472-473	R12744	246-247	R12889	450-451	R13068	458-459	R13244	386-387
R12517	134-135			712-713	R12745	132-133	R12890	450-451	R13069	458-459	R13245	386-387
R12525	654-655	R12616		472-473	R12746	398-399	R12894	124-125	R13070	458-459	R13246	386-387
R12527	428-429			712-713	R12747	398-399	R12896	306-307	R13071	458-459	R13247	386-387
R12528	466-467	R12618		472-473	R12748	446-447	R12897	306-307	R13072	458-459	R13248	386-387
	714-715			712-713	R12749	398-399	R12898	308-309	R13073	152-153	R13249	386-387
R12529	466-467	R12619		472-473	R12750	446-447	R12900	418-419	R13076	152-153	R13250	388-389
	716-717			712-713	R12751	118-119	R12901	204-205	R13077	152-153	R13251	388-389
R12530	480-481	R12621		472-473	R12760	452-453		260-261	R13078	152-153	R13252	388-389
	720-721			712-713	R12761	452-453	R12902	204-205	R13082	152-153	R13253	388-389
R12531	480-481	R12626		638-639	R12763	452-453	R12902	260-261	R13083	166-167	R13254	388-389
	720-721	R12627		476-477	R12764	452-453	R12903	202-203	R13084	166-167	R13255	388-389
R12533	478-479			716-717	R12765	452-453		260-261	R13085	166-167	R13256	388-389
	718-719	R12628		476-477	R12766	452-453	R12904	202-203	R13086	166-167	R13257	388-389
R12534	478-479			716-717	R12767	452-453		260-261	R13087	166-167	R13258	388-389
	718-719	R12633		130-131	R12768	452-453	R12905	202-203	R13088	166-167	R13259	388-389
R12535	478-479	R12634		130-131	R12770	452-453	R12906	202-203	R13089	166-167	R13260	388-389
	718-719	R12635		432-433	R12771	452-453	R12907	202-203	R13090	166-167	R13261	388-389
R12536	478-479	R12636		432-433	R12772	452-453	R12908	202-203	R13091	166-167	R13262	388-389
	718-719	R12637		296-297	R12773	452-453	R12911	398-399	R13104	298-299	R13263	388-389
R12537	478-479			432-433	R12774	452-453	R12912	288-289	R13105	298-299	R13264	388-389
	718-719	R12638		296-297	R12775	456-457	R12913	288-289	R13106	298-299	R13267	158-159
R12538	478-479			432-433	R12776	456-457	R12914	288-289	R13107	298-299	R13268	158-159
	718-719	R12639		194-195	R12777	456-457	R12915	288-289	R13108	298-299	R13271	28-29
R12539	262-263	R12640		194-195	R12778	456-457	R12916	288-289	R13109	298-299	R13275	30-31
	710-711	R12641		194-195	R12780	456-457	R12917	288-289	R13113	576-577	R13276	18-19
R12540	262-263	R12651		226-227	R12781	456-457	R12918	288-289	R13113	610-611	R13278	572-573
	710-711	R12652		226-227	R12782	456-457	R12919	288-289	R13114	576-577	R13279	572-573
R12541	262-263	R12654		608-609	R12783	456-457	R12920	288-289	R13114	610-611	R13280	24-25
	710-711	R12655		468-469	R12784	456-457	R12921	288-289	R13126	420-421	R13281	572-573
R12542	262-263	R12656		468-469	R12785	456-457	R12922	288-289	R13127	454-455	R13282	226-227
	710-711	R12657		404-405	R12786	456-457	R12923	288-289	R13128	454-455	R13283	340-341
R12544	262-263	R12659		404-405	R12787	456-457	R12924	288-289	R13130	454-455	R13284	218-219
	710-711	R12660		404-405	R12788	456-457	R12925	288-289	R13131	454-455	R13284	608-609
R12545	262-263	R12661		390-391	R12789	456-457	R12926	288-289	R13132	458-459	R13285	20-21
	710-711			724-725	R12790	150-151	R12927	616-617	R13133	458-459	R13288	428-429
R12547	262-263	R12663		44-45	R12791	150-151	R12930	616-617	R13134	458-459	R13289	18-19
	710-711	R12664		44-45	R12792	150-151	R12931	16-17	R13135	458-459	R13290	18-19
R12548	636-637	R12665		330-331	R12794	150-151	R12932	56-57	R13137	152-153	R13293	338-339
R12551	238-239	R12666		360-361	R12795	150-151	R12933	56-57	R13138	152-153	R13294	338-339
	656-657	R12667		136-137	R12798	150-151	R12934	56-57	R13139	152-153	R13295	338-339
	666-667	R12668		136-137	R12799	150-151	R12935	56-57	R13141	152-153	R13296	16-17
R12552	248-249	R12669		132-133	R12800	150-151	R12940	344-345	R13142	166-167	R13297	16-17
R12552	688-689	R12670		128-129	R12804	150-151	R12942	304-305	R13143	166-167	R13298	14-15
R12553	248-249	R12672		138-139	R12805	164-165	R12943	308-309	R13144	166-167	R13300	434-435
	688-689	R12673		138-139	R12806	164-165	R12944	304-305	R13145	166-167	R13302	434-435
	250-251	R12674		354-355	R12807	164-165	R12945	304-305	R13157	148-149	R13303	612-613
	688-689	R12675		342-343	R12808	164-165	R12947	610-611	R13158	158-159	R13304	612-613
R12556	240-241	R12677		250-251	R12810	164-165	R12949	184-185	R13163	538-539	R13315	22-23
	676-677	R12678		250-251	R12811	164-165	R12950	184-185	R13164	148-149	R13316	22-23
R12557	240-241	R12679		248-249	R12812	164-165		256-257	R13171	502-503	R13319	22-23
	676-677	R12680		248-249	R12813	164-165	R12951	184-185	R13172	502-503	R13320	334-335
R12559	662-663	R12681		136-137	R12814	164-165		256-257	R13173	502-503	R13321	22-23
R12560	668-669	R12682		136-137	R12815	164-165	R12954	256-257	R13177	148-149	R13324	330-331
R12561	668-669	R12684		136-137	R12816	164-165	R12955	220-221	R13178	148-149	R13325	330-331
R12562	672-673	R12685		470-471	R12817	164-165		276-277	R13182	60-61	R13328	74-75
R12563	664-665			714-715	R12818	164-165	R12956	222-223	R13183	60-61		144-145
R12564	664-665	R12686		470-471	R12823	504-505		276-277	R13184	60-61	R13329	74-75
R12565	664-665			714-715	R12824	504-505	R12957	222-223	R13201	554-555		144-145
R12566	664-665	R12687		466-467	R12825	238-239		280-281	R13202	554-555		74-75
R12567	666-667	R12688		466-467		656-657	R12960	690-691	R13203	554-555	R13330	74-75
R12568	662-663	R12690		474-475	R12827	250-251	R12963	460-461	R13204	554-555	R13331	74-75
R12569	662-663	R12691		692-693		688-689	R12965	460-461	R13205	546-547	R13332	74-75
R12571	692-693	R12695		432-433	R12829	686-687	R12973	168-169	R13206	546-547	R13333	74-75
R12573	252-253	R12696		432-433	R12831	248-249	R12977	544-545	R13207	516-517		144-145
	660-661	R12697		436-437		686-687	R12978	544-545	R13208	516-517	R13334	74-75
R12574	252-253	R12699		436-437	R12832	248-249	R12982	696-697	R13209	548-549		144-145
	660-661	R12700		436-437		686-687	R12986	310-311	R13210	548-549		74-75
R12575	246-247	R12702		436-437	R12839	126-127	R12989	368-369	R13211	554-555	R13337	186-187
R12576	474-475	R12703		436-437	R12840	126-127	R12990	60-61	R13212	552-553	R13338	324-325
	716-717	R12704		436-437	R12842	146-147	R12991	60-61	R13213	552-553	R13339	612-613
R12577	474-475	R12705		436-437	R12843	146-147	R12992	60-61	R13214	552-553	R13340	612-613
	716-717	R12707		434-435	R12844	146-147	R12993	538-539	R13215	526-527	R13344	578-579
R12578	696-697	R12709		436-437	R12845	146-147	R12994	538-539	R13216	526-527	R13345	18-19
R12579	698-699	R12710		436-437	R12846	76-77	R12995	502-503	R13217	526-527	R13346	540-541
R12580	700-701	R12711		436-437	R12848	156-157	R12996	502-503	R13218	522-523	R13347	540-541
R12581	192-193	R12712		436-437	R12849	156-157	R12997	502-503	R13221	384-385	R13348	506-507
R12583	604-605	R12713		436-437	R12850	156-157	R12998	232-233	R13222	384-385	R13349	506-507
R12584	604-605	R12716		394-395	R12851	156-157	R12999	228-229	R13223	384-385	R13350	504-541
R12585	242-243	R12717		394-395	R12852	78-79	R13000	504-505	R13224	384-385	R13351	504-541
	684-685	R12718		82-83	R12853	78-79	R13048	70-71	R13225	384-385	R13352	508-509
	252-253	R12719		82-83	R12854	438-439	R13049	584-585	R13226	384-385	R13353	508-509
R12587	238-239	R12720		82-83	R12856	438-439	R13050	584-585	R13227	384-385	R13360	24-25
R12589	246-247	R12721		82-83	R12857	438-439	R13051	582-583	R13228	384-385	R13361	140-141
R12591	246-247	R12722		462-463	R12858	438-439	R13052	582-583	R13229	384-385	R13362	140-141
R12592	242-243	R12729		136-137	R12870	450-451	R13053	454-455	R13230	384-385	R13363	126-127
R12593	242-243	R12730		136-137	R12871	450-451	R13054	454-455	R13231	384-385		312-313
R12595	252-253	R12731		136-137	R12872	450-451	R13055	454-455	R13232	384-385		126-127
R12596	238-239	R12732		136-137	R12875	450-451	R13056	454-455	R13233	384-385	R13364	312-313
R12598	248-249	R12733		136-137	R12876	450-451	R13058	454-455	R13234	384-385	R13365	

R13374	294-295	R13554	188-189	R13652	42-43	R13776	500-501	R13897	64-65	R14004	408-409
R13375	294-295		258-259	R13653	358-359	R13777	62-63	R13898	64-65	R14005	412-413
R13376	294-295	R13555	184-185	R13654	642-643	R13778	62-63	R13899	64-65	R14006	414-415
R13377	208-209		258-259	R13658	42-43	R13779	312-313	R13900	64-65	R14007	410-411
	274-275	R13556	310-311	R13660	368-369	R13780	312-313	R13901	310-311	R14008	410-411
R13378	208-209	R13558	344-345	R13661	220-221	R13781	536-537	R13902	310-311	R14009	410-411
	274-275	R13559	682-683		276-277	R13782	536-537	R13903	342-343	R14010	414-415
R13379	208-209	R13560	682-683	R13662	220-221	R13783	500-501	R13904	342-343	R14011	406-407
	274-275	R13561	680-681		276-277	R13784	500-501	R13905	342-343	R14012	412-413
R13380	208-209	R13562	246-247	R13663	328-329	R13788	14-15	R13906	342-343	R14013	412-413
	274-275		670-671	R13664	328-329	R13789	116-117	R13907	338-339	R14014	414-415
R13391	446-447	R13563	658-659	R13665	366-367	R13790	118-119	R13908	58-59	R14015	414-415
R13394	356-357	R13564	658-659	R13666	366-367	R13791	116-117	R13909	58-59	R14016	406-407
R13397	24-25	R13565	658-659	R13667	394-395	R13792	228-229	R13910	58-59	R14017	408-409
R13398	28-29	R13566	464-465	R13668	394-395		678-679	R13911	58-59	R14019	50-51
R13401	452-453		722-723	R13676	96-97	R13793	678-679	R13912	58-59	R14020	50-51
R13402	452-453	R13567	464-465	R13677	96-97	R13794	678-679	R13913	58-59	R14021	50-51
R13404	150-151		722-723	R13678	96-97	R13795	120-121	R13914	284-285	R14022	50-51
R13405	150-151	R13568	700-701	R13679	96-97	R13796	646-647		300-301	R14023	50-51
R13417	578-579	R13569	658-659	R13680	98-99	R13797	646-647	R13915	284-285	R14024	50-51
R13418	28-29	R13570	148-149	R13681	98-99	R13807	122-123		300-301	R14025	50-51
R13419	28-29	R13571	278-279	R13682	104-105	R13808	122-123	R13916	300-301	R14026	50-51
R13423	280-281	R13582	448-449	R13683	104-105	R13809	616-617	R13917	300-301	R14027	50-51
R13429	346-347	R13583	448-449	R13684	104-105	R13814	516-517	R13918	290-291	R14028	50-51
R13430	396-397	R13584	448-449		124-125	R13815	518-519	R13919	290-291	R14029	50-51
R13432	396-397	R13585	448-449	R13685	104-105	R13816	528-529	R13920	290-291	R14030	50-51
R13433	228-229	R13586	448-449		124-125	R13817	528-529	R13921	290-291	R14031	340-341
R13435	230-231	R13587	448-449	R13686	102-103	R13818	528-529	R13922	290-291	R14032	340-341
R13436	236-237	R13588	448-449	R13687	102-103	R13819	524-525	R13923	290-291	R14033	326-327
R13437	614-615	R13589	448-449	R13688	102-103	R13821	50-51	R13924	290-291	R14034	332-333
R13438	120-121	R13590	448-449	R13689	106-107	R13822	50-51	R13925	290-291	R14035	328-329
R13439	724-725	R13591	448-449	R13690	106-107	R13823	50-51	R13926	540-541	R14036	334-335
R13441	454-455	R13598	400-401	R13691	206-207	R13824	44-45	R13927	540-541	R14037	326-327
R13442	454-455	R13599	400-401		272-273	R13825	44-45	R13928	508-509	R14038	326-327
R13444	152-153	R13600	400-401	R13692	36-37	R13826	40-41	R13929	508-509	R14039	328-329
R13445	152-153	R13601	400-401	R13693	106-107	R13827	40-41	R13930	632-633	R14040	322-323
R13446	538-539	R13602	392-393	R13694	106-107	R13841	576-577	R13931	632-633	R14041	322-323
R13450	110-111	R13603	404-405	R13695	206-207	R13842	238-239	R13932	632-633	R14042	324-325
	648-649	R13604	398-399		272-273	R13843	148-149	R13933	264-265	R14043	352-353
R13451	110-111	R13605	404-405	R13696	206-207	R13844	148-149		706-707	R14044	352-353
	648-649	R13606	110-111		272-273	R13848	538-539	R13934	264-265	R14045	352-353
R13452	110-111	R13607	110-111	R13697	114-115	R13849	538-539		706-707	R14046	352-353
	648-649	R13608	110-111	R13698	114-115	R13851	158-159	R13935	264-265	R14047	332-333
R13471	132-133	R13609	250-251	R13703	206-207	R13852	188-189		706-707	R14048	332-333
R13472	132-133	R13609	674-675	R13703	272-273		258-259	R13936	642-643	R14049	332-333
R13473	132-133	R13610	250-251	R13704	206-207	R13853	186-187	R13938	158-159	R14050	332-333
R13474	132-133		674-675		272-273		258-259	R13939	158-159	R14051	332-333
R13475	132-133	R13611	250-251	R13707	162-163	R13854	518-519	R13940	60-61	R14052	332-333
R13476	132-133		674-675	R13708	162-163	R13855	516-517	R13941	282-283	R14053	332-333
R13479	146-147	R13612	278-279	R13709	80-81	R13856	516-517	R13942	368-369	R14054	332-333
R13480	146-147	R13613	278-279	R13710	80-81	R13857	526-527	R13954	466-467	R14055	334-335
R13481	146-147	R13614	630-631	R13711	162-163	R13858	526-527	R13955	466-467	R14056	334-335
R13482	146-147	R13615	254-255	R13712	162-163	R13859	524-525	R13956	466-467	R14057	334-335
R13483	146-147		656-657	R13713	80-81	R13860	550-551	R13957	466-467	R14058	334-335
R13484	146-147		672-673	R13714	80-81	R13861	550-551	R13958	474-475	R14059	334-335
R13485	146-147	R13616	254-255	R13720	552-553	R13862	552-553	R13963	548-549	R14060	334-335
R13486	146-147		656-657	R13721	520-521	R13863	552-553	R13964	546-547	R14061	334-335
R13487	156-157	R13616	672-673	R13726	554-555	R13864	564-565	R13965	546-547	R14062	334-335
R13488	156-157	R13617	704-705	R13730	154-155	R13865	564-565	R13966	546-547	R14063	336-337
R13489	156-157	R13618	704-705	R13731	496-497	R13866	564-565	R13967	514-515	R14064	336-337
R13490	156-157	R13619	600-661	R13732	496-497	R13867	128-129	R13968	514-515	R14065	354-355
R13492	606-607	R13620	476-477	R13735	186-187		314-315	R13969	514-515	R14066	354-355
R13493	606-607		718-719		258-259	R13868	128-129	R13970	554-555	R14067	356-357
R13494	606-607	R13621	476-477	R13736	240-241		314-315	R13971	554-555	R14068	356-357
R13495	606-607	R13621	718-719		676-677	R13869	128-129	R13972	554-555	R14069	362-363
R13496	130-131	R13622	648-649	R13737	240-241		314-315	R13973	554-555	R14070	362-363
R13497	542-543	R13623	648-649		676-677	R13870	542-543	R13974	522-523	R14071	362-363
R13498	542-543	R13624	650-651	R13738	240-241	R13871	542-543	R13975	522-523	R14072	362-363
R13499	506-507	R13625	650-651		676-677	R13872	542-543	R13976	522-523	R14073	360-361
R13500	506-507	R13626	112-113	R13739	240-241	R13873	506-507	R13977	522-523	R14074	364-365
R13501	130-131		648-649		676-677	R13874	506-507	R13978	548-549	R14075	364-365
R13502	682-683	R13627	112-113	R13742	98-99	R13875	506-507	R13979	520-521	R14076	364-365
R13503	650-651		648-649	R13743	148-149	R13876	128-129	R13980	552-553	R14077	364-365
R13504	668-669	R13628	112-113	R13745	36-37		314-315	R13981	552-553	R14078	364-365
R13505	644-645		650-651	R13746	36-37		506-507	R13982	552-553	R14079	362-363
R13507	644-645	R13629	112-113	R13747	36-37		542-543	R13983	526-527	R14080	362-363
R13508	644-645		650-651	R13748	28-29	R13877	128-129	R13984	526-527	R14081	362-363
R13509	644-645	R13630	698-699	R13752	40-41		314-315	R13985	526-527	R14082	362-363
R13510	650-651	R13631	650-651	R13753	40-41		506-507	R13986	550-551	R14083	362-363



 **rendl light studio**

www.rendl.es